

2012

JEEP®-TRUCK-SUV-OFFROAD

MASTER CATALOG

PERFORMANCE PARTS - ACCESSORIES - REPLACEMENT PARTS



OWN A JEEP?

The toughest four letter word on wheels. Are you looking for a parts source rugged enough to match your off the beaten path sense of adventure? With more than 15,000 unique part numbers from brands like Omix-ADA®, Rugged Ridge®, Alloy USA®, Outland Automotive®, ORV™ Suspension and Precision Gear®, consider this your trail guide to the 4x4 of your dreams. A go anywhere, anytime, in any weather vehicle. Go ahead and smile, because it's going to take a lot of courage not to be cocky when you own a Jeep® like that.



WHO WE ARE

Omix-ADA, Inc.® is more than just a parts manufacturer, we're a community of enthusiasts dedicated to producing the finest in off road solutions. Our products have been propelling four-wheel drive vehicles down highways, back roads and over the world's roughest terrain for over a decade. Omix-ADA's® team of engineers have developed, tested and trail ridden thousands of new products until they were perfected for you.



AWARD WINNING DESIGNS

More than 2,500 new products are displayed at the SEMA Show every year. Groups of journalists and industry experts are charged with the task of judging the most innovative new products introduced into the automotive industry. Omix-ADA® emerged as one of the most decorated companies in the off road sector, and has won numerous awards over the years. The legacy still continues.



LICENSED PARTS

Why have we put so much time and energy into developing the most expansive collection of Jeep® parts available under one roof? Because the items bearing our logo are more than just parts, they are built with a legacy and heritage in mind. This is why we have been authorized to use the "MOPAR Authentic Restoration" and "MOPAR Official Licensed Product" logos for the more than 30 licensed parts we produce. We take pride in being one of the few manufacturers strong enough to stand behind the legendary Jeep® name.

THE OMIX-ADA® BRANDS



OMIX-ADA, Inc.

Omix-ADA, Inc.®
omix-ada.com

The parent company brand that offers thousands of parts and components for all Jeep® vehicles built from 1941 to current!



Rugged Ridge®
ruggedridge.com

Featuring the most complete line of high quality and functional accessories for your Jeep® vehicle.



Alloy USA®
alloyusa.com

A full line of the highest quality, high performance off road and racing alloy axles, and ring & pinions.



Outland®
outlandautomotive.com

Offering a full line of truck/SUV tube steps, bull bars, consoles and other functional accessories.



ORV™ Suspension
ruggedridge.com

ORV™ offers a full line of heavy duty suspension options to upgrade your vehicles off road capabilities.



Precision Gear®
precisiongear.com

Featuring a full line of heavy duty upgraded ring and pinion sets to make your vehicle run as efficiently as possible.

WRANGLER 07-12

CJ & WRANGLER 76-06

CHEROKEE 94-12

ACCESSORIES

ORV™ SUSPENSION

ALLOY USA® / PRECISION GEAR

REPLACEMENT PARTS

WARRANTIES

We offer a minimum 3 Year Limited Warranty on all of our products. We've got you covered!



find us on facebook
facebook.com/ruggedridge



**INTERIOR**

| | |
|---------------------------------|---------|
| FLOOR LINERS | J24 |
| GRAB HANDLES | J35 |
| HARD TOP INSULATION | J23 |
| HEAVY-DUTY OFF ROAD ACCESSORIES | J43-J44 |
| INTERIOR STORAGE | J26 |
| INTERIOR TRIM | J29-J31 |
| OFF ROAD ACCESSORIES | J53 |
| ORGANIZERS | J25-J26 |
| OVERHEAD CONSOLES | J25 |
| INTERIOR ACCESSORIES | J33-J35 |
| SEATING | J27-J28 |

PERFORMANCE

| | |
|-------------------|-----|
| AIR INTAKES | J45 |
| DUAL BATTERY TRAY | J47 |
| HEADERS/EXHAUST | J44 |

EXTERIOR

| | |
|---------------------------------------|---------|
| BLACK EXTERIOR ACCESSORIES | J36-J38 |
| BODY ARMOR | J39 |
| BUMPER SYSTEMS | J8-J12 |
| COVERS | J23 |
| DOORS | J32 |
| DOOR ACCESSORIES | J32-J33 |
| EXTERIOR ENHANCEMENTS | J36-J42 |
| FENDER FLARES | J15 |
| OFF ROAD LIGHTING | J49-J52 |
| REPLACEMENT MIRRORS | J33 |
| SKID PLATES | J43 |
| STAINLESS/CHROME EXTERIOR ACCESSORIES | J40-J42 |
| STORAGE BOOT/TIRE COVERS | J22 |
| TOPS/SUMMER BRIEFS/ ISLAND TOPPERS | J18-J21 |
| TUBE STEPS, SIDE PROTECTION | J13-J14 |
| WHEELS & ACCESSORIES | J16-J17 |
| WINCHES & RECOVERY GEAR | J46-48 |

SUSPENSION

| | |
|----------------------|-----|
| SUSPENSION KITS | J55 |
| SHOCKS & STABILIZERS | J56 |

AXLE

| | |
|----------------------------|-----|
| AXLE KITS | J59 |
| RING & PINIONS | J60 |
| WHEEL SPACERS | J60 |
| AXLE & DIFFERENTIAL COVERS | J60 |



COASTAL CRUISER

The Coastal Cruiser package by Rugged Ridge® is ideal for the beach and water lover. The package will fit your lifestyle to make everyday an adventure. The items selected that complete the Coastal Cruiser package are not just stylish but also functional. So when the weekend comes take the top down and turn the tunes up, load the cooler and take in that warm summer breeze and smell the fresh coastal air. You now can make every ride feel like you're on vacation if you're at the creek or on the beach.

ROCK RUGGED

Rugged Ridge® knows rugged and we know how to rock your Jeep®. The Rock Rugged package by Rugged Ridge® has all the tools that can take your rig where no one else can. The stylish look and the functionality from the interior to the winch will allow you to make your Jeep® look good and dominate the trails. So if you want a ride that will take you off-road beyond the muddy trails. Make sure your rig is equipped with the Rock Rugged package by Rugged Ridge®, for the serious off-road enthusiast.



TRAIL DUSTER

Now a complete package that can make your everyday driver look good and have the attitude to take you where you want to go. The Trail Duster package by Rugged Ridge® allows you to have the best of both worlds. Now you have the flexibility and the look to do what you want when you want. The Trail Duster will get you to work or through the toughest trails. Don't be left behind, take pride in your ride with the Trail Duster package by Rugged Ridge®.



LOW LANDER

When the urban dweller needs to put a little bling on their ride. The Low Lander package by Rugged Ridge® gives you the look from the exterior chrome to the interior trim. The low Lander package will give you the style and individuality you're looking for. The Low Lander package will make your rig look like it belongs in a show but has the functionality to fit your personal lifestyle.



WEEKEND WILD

Pack the cooler and the tent, throw the bike on the back because the weekend is here. The Weekend Wild package by Rugged Ridge® is built for the weekends. Now when Friday comes your rig can take you places that your boss can't go. From the highway to the byways from 65mph to 10mph your rig will take you where you want to go so you can kick back and enjoy some well deserved R&R with your friends when you put your Jeep® in low gear with the Weekend Wild package by Rugged Ridge®.



COASTAL CRUISER

The Coastal Cruiser package by Rugged Ridge® is ideal for the beach and water lover. The package will fit your lifestyle to make everyday an adventure. The items selected that complete the Coastal Cruiser package are not just stylish but also functional.



2-Door Kit: 12498.01
4-Door Kit: 12498.02

| Coastal Cruiser - 07-10 Wrangler (JK) 4-Door | Part # | QTY |
|---|----------|-----|
| Stubby Tube Bumper, With Winch Cutout, Text Black | 11561.12 | 1 |
| 8,500lb Winch with Synthetic Rope | 15100.02 | 1 |
| Rear Tube Bumper, Textured Black | 11571.10 | 1 |
| 4" Oval Side Tube Steps, Textured Black | 11591.08 | 1 |
| Satin Black Wheels for JK | 15301.01 | 5 |
| Cowl Body Armor | 11651.18 | 1 |
| Windshield Light Brackets, Black | 11027.03 | 1 |
| Slim Light Kit, Black, Pair | 15207.58 | 1 |
| Mirror Relocation Brackets, Black | 11025.04 | 1 |
| Black Grille Inserts | 11306.30 | 1 |
| Headlight Bezels, Black | 12419.25 | 1 |
| Black Door Recess Guards, 4 Dr Kit | 11651.26 | 1 |
| Padded Arm Rest, Gray * | 13107.09 | 1 |
| Ultimate Grab Handles | 13505.04 | 1 |
| Rear Side Grab Handles | 13305.14 | 1 |
| Front Neo Seat Covers, Gray 4 Dr * | 13214.09 | 1 |
| Rear Neo Seat covers, Gray 4 Dr * | 13264.09 | 1 |
| Sunglass Holder/Organizer | 12101.52 | 1 |
| Windshield Header | 13308.05 | 1 |
| Island Topper, 4 Door Diamond Black * | 13589.35 | 1 |
| Front All Terrain Floor Liners | 12920.01 | 1 |
| Rear All Terrain Floor Liners, 4 Door | 12950.01 | 1 |
| All Terrain Cargo Liner | 12975.01 | 1 |

| Coastal Cruiser - 07-10 Wrangler (JK) 2-Door | Part # | QTY |
|---|----------|-----|
| Stubby Tube Bumper, With Winch Cutout, Text Black | 11561.12 | 1 |
| 8,500lb Winch with Synthetic Rope | 15100.02 | 1 |
| Rear Tube Bumper, Textured Black | 11571.10 | 1 |
| 4" Oval Side Tube Steps, Textured Black | 11591.08 | 1 |
| Satin Black Wheels for JK | 15301.01 | 5 |
| Cowl Body Armor | 11651.18 | 1 |
| Windshield Light Brackets, Black | 11027.03 | 1 |
| Slim Light Kit, Black, Pair | 15207.58 | 1 |
| Mirror Relocation Brackets, Black | 11025.04 | 1 |
| Black Grille Inserts | 11306.30 | 1 |
| Headlight Bezels, Black | 12419.25 | 1 |
| Black Door Recess Guards, 2 Dr Kit | 11651.25 | 1 |
| Padded Arm Rest, Gray * | 13107.09 | 1 |
| Ultimate Grab Handles | 13505.04 | 1 |
| Front Neo Seat Covers, Gray 2 Dr * | 13214.09 | 1 |
| Rear Neo Seat covers, Gray 2 Dr * | 13265.09 | 1 |
| Sunglass Holder/Organizer | 12101.52 | 1 |
| Windshield Header | 13308.05 | 1 |
| Island Topper, 2 Door Diamond Black * | 13588.35 | 1 |
| Front All Terrain Floor Liners | 12920.01 | 1 |
| Rear All Terrain Floor Liners, 2 Door | 12950.02 | 1 |
| All Terrain Cargo Liner | 12975.01 | 1 |

*Fits 2007-2010 Wranglers only. Separate applications available for 2011-2012 vehicles.

ROCK RUGGED

Rugged Ridge® knows rugged and we know how to rock your Jeep®. The Rock Rugged package by Rugged Ridge® has all the tools to take your rig where no one else can. The stylish look and the functionality from the interior to the winch will allow you to make your Jeep® look good and dominate the trails.



2-Door Kit: 12498.11
4-Door Kit: 12498.12

Rock Rugged - 07-10 Wrangler (JK) 4-Door

| Part # | QTY |
|--|------------|
| XHD Center Base With Winch Cutout | 11540.10 1 |
| XHD Stinger | 11540.13 1 |
| D-Rings | 11235.01 1 |
| XHD Rear Bumper | 11546.20 1 |
| XHD Rear Bumper Tire Carrier | 11546.22 1 |
| Off Road Jack Mount | 11586.01 1 |
| Tire Carrier Linkage | 11503.91 1 |
| RRC Rock Sliders, 4 Door | 11504.22 1 |
| Front Skid Plate for JK | 18003.30 1 |
| Evap Skid Plate for JK** | 18003.40 1 |
| Muffler Skid for JK | 18003.31 1 |
| Front/Rear Control Arm Skids for JK | 18003.37 1 |
| 4" ORV™ Lift Kit With Shocks | 18415.60 1 |
| Drop Pitman Arm, JK | 18006.55 1 |
| 10,500lb Winch with Synthetic Rope | 15100.11 1 |
| Flat Fender Flares for JK | 11620.10 1 |
| Satin Wheels for JK | 15301.01 5 |
| Black Rim Protectors | 15250.02 5 |
| Cowl Body Armor | 11651.18 1 |
| Dual Battery Tray, JK** | 11214.53 1 |
| Windshield Mount Light Bar | 11232.21 1 |
| 7" HID Lighting Kit, 2pc | 15205.53 1 |
| 7" HID Lighting Kit, 3pc | 15205.63 1 |
| Mirror Relocation Brackets, Black | 11025.04 1 |
| Front Headlight Euro Guards | 11230.03 1 |
| Turn Signal Euro Guards | 11231.11 1 |
| Rear Euro Guards, Black | 11226.02 1 |
| Locking Black SS Fuel Cover | 11229.03 1 |
| Padded Arm Rest, Gray * | 13107.01 1 |
| Ultimate Grab Handles | 13505.04 1 |
| Rear Side Grab Handles | 13305.14 1 |
| Fire Extinguisher Holder, Roll Bar Mount | 13305.21 1 |
| Roll Bar Flashlight Holder | 11205.20 1 |
| Front Seat Protectors, Black | 13235.30 1 |
| Dash Organizer/CB Mount* | 13551.10 1 |
| Front All Terrain Floor Liners | 12920.01 1 |
| Rear All Terrain Floor Liners, 4 Door | 12950.01 1 |
| All Terrain Cargo Liner | 12975.01 1 |

Rock Rugged - 07-10 Wrangler (JK) 2-Door

| Part # | QTY |
|--|------------|
| XHD Center Base With Winch Cutout | 11540.10 1 |
| XHD Stinger | 11540.13 1 |
| D-Rings | 11235.01 1 |
| XHD Rear Bumper | 11546.20 1 |
| XHD Rear Bumper Tire Carrier | 11546.22 1 |
| Off Road Jack Mount | 11586.01 1 |
| Tire Carrier Linkage | 11503.91 1 |
| RRC Rock Sliders, 4 Door | 11504.23 1 |
| Front Skid Plate for JK | 18003.30 1 |
| Evap Skid Plate for JK** | 18003.40 1 |
| Muffler Skid for JK | 18003.31 1 |
| Front/Rear Control Arm Skids for JK | 18003.37 1 |
| 5" ORV™ Lift Kit With Shocks | 18415.60 1 |
| Drop Pitman Arm, JK | 18006.55 1 |
| 8,500lb Winch with Synthetic Rope | 15100.02 1 |
| Flat Fender Flares for JK | 11620.10 1 |
| Satin Wheels for JK | 15301.01 5 |
| Black Rim Protectors | 15250.02 5 |
| Cowl Body Armor | 11651.18 1 |
| Dual Battery Tray, JK** | 11214.53 1 |
| Windshield Mount Light Bar | 11232.21 1 |
| 7" HID Lighting Kit, 2pc | 15205.53 1 |
| 7" HID Lighting Kit, 3pc | 15205.63 1 |
| Mirror Relocation Brackets, Black | 11025.04 1 |
| Front Headlight Euro Guards | 11230.03 1 |
| Turn Signal Euro Guards | 11231.11 1 |
| Rear Euro Guards, Black | 11226.02 1 |
| Locking Black SS Fuel Cover | 11229.03 1 |
| Padded Arm Rest, Gray * | 13107.01 1 |
| Ultimate Grab Handles | 13505.04 1 |
| Fire Extinguisher Holder, Roll Bar Mount | 13305.21 1 |
| Roll Bar Flashlight Holder | 11205.20 1 |
| Front Seat Protectors, Black | 13235.30 1 |
| Dash Organizer/CB Mount* | 13551.10 1 |
| Front All Terrain Floor Liners | 12920.01 1 |
| Rear All Terrain Floor Liners, 4 Door | 12950.02 1 |
| All Terrain Cargo Liner | 12975.01 1 |

*Fits 2007-2010 Wranglers only. Separate applications available for 2011-2012 vehicles.

**Fits 2007-2011 Wranglers only.



Now a complete package that can make your everyday driver look good and have the attitude to take you where you want to go. The Trail Duster package by Rugged Ridge® allows you to have the best of both worlds. Now you have the flexibility and the look to do what you want when you want.

2-Door Kit: 12498.21
4-Door Kit: 12498.22

Wrangler 07-12

| Trail Duster - 07-10 Wrangler (JK) 4-Door | Part # | QTY |
|---|----------|-----|
| XHD Center Base With Winch Cutout | 11540.10 | 1 |
| Standard Ends for XHD | 11540.12 | 1 |
| Hoop Overrider | 11540.14 | 1 |
| XHD Rear Bumper | 11546.20 | 1 |
| XHD Rear Bumper Tire Carrier | 11546.22 | 1 |
| Off Road Jack Mount | 11586.01 | 1 |
| Tire Carrier Linkage | 11503.91 | 1 |
| RRC Side Armor 4 Door | 11504.20 | 1 |
| Front Skid Plate for JK | 18003.30 | 1 |
| 2.5" ORV™ Lift Kit With Shocks | 18415.50 | 1 |
| 10,500lb Winch With Steel Cable | 15100.10 | 1 |
| Roller Fairlead License Plate Holder | 11238.05 | 1 |
| Satin Black Wheels for JK | 15301.01 | 5 |
| Black Rim Protectors | 15250.02 | 5 |
| Cowl Body Armor | 11651.18 | 1 |
| 5" HID Lighting Kit, Pair | 15205.54 | 1 |
| Light Mount Clamp | 11503.82 | 2 |
| Mirror Relocation Brackets, Black | 11025.04 | 1 |
| Front Headlight Euro Guards | 11230.03 | 1 |
| Parking Light Euro Guards | 11231.11 | 1 |
| Rear Euro Guards, Black | 11226.02 | 1 |
| Locking Black Fuel Cover | 11229.03 | 1 |
| Padded Arm Rest, Black * | 13107.01 | 1 |
| Ultimate Grab Handles | 13505.04 | 1 |
| Rear Side Grab Handles | 13305.14 | 1 |
| Fire Extinguisher Holder, Roll Bar Mount | 13305.21 | 1 |
| Roll Bar Flashlight Holder | 11205.20 | 1 |
| Front Seat Protectors, Black | 13235.30 | 1 |
| Dash Organizer/CB Mount* | 13551.10 | 1 |
| Front All Terrain Floor Liners | 12920.01 | 1 |
| Rear All Terrain Floor Liners, 4 Door | 12950.01 | 1 |
| All Terrain Cargo Liner | 12975.01 | 1 |

| Trail Duster - 07-10 Wrangler (JK) 2-Door | Part # | QTY |
|---|----------|-----|
| XHD Center Base With Winch Cutout | 11540.10 | 1 |
| Standard Ends for XHD | 11540.12 | 1 |
| Hoop Overrider | 11540.14 | 1 |
| XHD Rear Bumper | 11546.20 | 1 |
| XHD Rear Bumper Tire Carrier | 11546.22 | 1 |
| Off Road Jack Mount | 11586.01 | 1 |
| Tire Carrier Linkage | 11503.91 | 1 |
| RRC Side Armor 2 Door | 11504.21 | 1 |
| Front Skid Plate for JK | 18003.30 | 1 |
| 3.5" ORV™ Lift Kit With Shocks | 18415.50 | 1 |
| 8,500lb Winch With Steel Cable | 15100.01 | 1 |
| Roller Fairlead License Plate Holder | 11238.05 | 1 |
| Satin Black Wheels for JK | 15301.01 | 5 |
| Black Rim Protectors | 15250.02 | 5 |
| Cowl Body Armor | 11651.18 | 1 |
| 5" HID Lighting Kit, Pair | 15205.54 | 1 |
| Light Mount Clamp | 11503.82 | 2 |
| Mirror Relocation Brackets, Black | 11025.04 | 1 |
| Front Headlight Euro Guards | 11230.03 | 1 |
| Parking Light Euro Guards | 11231.11 | 1 |
| Rear Euro Guards, Black | 11226.02 | 1 |
| Locking Black Fuel Cover | 11229.03 | 1 |
| Padded Arm Rest, Black * | 13107.01 | 1 |
| Ultimate Grab Handles | 13505.04 | 1 |
| Fire Extinguisher Holder, Roll Bar Mount | 13305.21 | 1 |
| Roll Bar Flashlight Holder | 11205.20 | 1 |
| Front Seat Protectors, Black | 13235.30 | 1 |
| Dash Organizer/CB Mount* | 13551.10 | 1 |
| Front All Terrain Floor Liners | 12920.01 | 1 |
| Rear All Terrain Floor Liners, 2 Door | 12950.02 | 1 |
| All Terrain Cargo Liner | 12975.01 | 1 |

*Fits 2007-2010 Wranglers only. Separate applications available for 2011-2012 vehicles.

**Fits 2007-2011 Wranglers only.

LOW LANDER

When the urban dweller needs to put a little bling on their ride. The Low Lander package by Rugged Ridge® gives you the look from the exterior chrome to the interior trim. The low Lander package will give you the style and individuality you're looking for.



2-Door Kit: 12498.31
4-Door Kit: 12498.32

Low Lander - 07-10 Wrangler (JK) 4-Door

Part # QTY

| | | |
|---|----------|---|
| Front Tube Bumper, No Winch Cutout, Stainless | 11563.10 | 1 |
| Rear Tube Bumper, Stainless Steel | 11573.10 | 1 |
| 4" Oval Side Tube Steps, Stainless Steel | 11593.08 | 1 |
| Chrome Wheels for JK | 15301.20 | 5 |
| Hood Latches, Stainless Steel, JK | 11116.06 | 1 |
| Hood Kit, Stainless Steel, JK | 11101.04 | 1 |
| Stainless Steel Windshield Hinge Bracket | 11112.03 | 1 |
| Chrome Door Handles/Recess Guard Kit, 4 Door | 13311.18 | 1 |
| Stainless Steel Hinge Covers, 4 Door JK | 11113.06 | 1 |
| Mirror Cover Kit, JK | 13311.03 | 1 |
| Tailgate Hinge Covers, Chrome, JK | 13311.21 | 1 |
| Antenna Base Cover, JK | 13311.26 | 1 |
| Chrome Grille Inserts | 11306.20 | 1 |
| Headlight Bezels, Chrome | 13311.20 | 1 |
| Headlight Euroguards, Stainless Steel | 11142.04 | 1 |
| Turn Signal Guards, Stainless Steel | 11142.11 | 1 |
| Side Marker Guards, Stainless Steel | 11142.12 | 1 |
| Rear Euroguards, Stainless Steel | 11103.03 | 1 |
| Stainless Steel Polished Fuel Cover | 11134.02 | 1 |
| Padded Arm Rest, Gray/Black * | 13107.09 | 1 |
| Ultimate Grab Handles | 13505.04 | 1 |
| Rear Side Grab Handles | 13305.14 | 1 |
| Front Neo Seat Covers, Gray 4-Door * | 13214.09 | 1 |
| Rear Neo Seat Covers, Gray 4-Door * | 13264.09 | 1 |
| Sunglass Holder/Organizer | 12101.52 | 1 |
| Billet Climate Control Knobs * | 11420.06 | 1 |
| Interior Trim Kit, Chrome * | 11156.96 | 1 |
| Rear Seat Organizer, JK * | 13551.15 | 1 |
| Front All Terrain Floor Liners | 12920.01 | 1 |
| Rear All Terrain Floor Liners, 4-Door | 12950.01 | 1 |
| All Terrain Cargo Liner | 12975.01 | 1 |

Low Lander - 07-10 Wrangler (JK) 2-Door

Part # QTY

| | | |
|---|----------|---|
| Front Tube Bumper, No Winch Cutout, Stainless | 11563.10 | 1 |
| Rear Tube Bumper, Stainless Steel | 11573.10 | 1 |
| 4" Oval Side Tube Steps, Stainless Steel | 11593.08 | 1 |
| Chrome Wheels for JK | 15301.20 | 5 |
| Hood Latches, Stainless Steel, JK | 11116.06 | 1 |
| Hood Kit, Stainless Steel, JK | 11101.04 | 1 |
| Stainless Steel Windshield Hinge Bracket | 11112.03 | 1 |
| Chrome Door Handles/Recess Guard Kit, 2 Door | 13311.17 | 1 |
| Stainless Steel Hinge Covers, 2-Door JK | 11113.05 | 1 |
| Mirror Cover Kit, JK | 13311.03 | 1 |
| Tailgate Hinge Covers, Chrome, JK | 13311.21 | 1 |
| Antenna Base Cover, JK | 13311.26 | 1 |
| Chrome Grille Inserts | 11306.20 | 1 |
| Headlight Bezels, Chrome | 13311.20 | 1 |
| Headlight Euroguards, Stainless Steel | 11142.04 | 1 |
| Turn Signal Guards, Stainless Steel | 11142.11 | 1 |
| Side Marker Guards, Stainless Steel | 11142.12 | 1 |
| Rear Euroguards, Stainless Steel | 11103.03 | 1 |
| Stainless Steel Polished Fuel Cover | 11134.02 | 1 |
| Padded Arm Rest, Gray/Black * | 13107.09 | 1 |
| Ultimate Grab Handles | 13505.04 | 1 |
| Front Neo Seat Covers, Gray 2-Door * | 13214.09 | 1 |
| Rear Neo Seat Covers, Gray 2-Door * | 13264.09 | 1 |
| Sunglass Holder/Organizer | 12101.52 | 1 |
| Billet Climate Control Knobs * | 11420.06 | 1 |
| Interior Trim Kit, Chrome * | 11156.96 | 1 |
| Rear Seat Organizer, JK * | 13551.15 | 1 |
| Front All Terrain Floor Liners | 12920.01 | 1 |
| Rear All Terrain Floor Liners, 2-Door | 12950.01 | 1 |
| All Terrain Cargo Liner | 12975.01 | 1 |

*Fits 2007-2010 Wranglers only. Separate applications available for 2011-2012 vehicles.



Wrangler 07-12

Weekend Wild - 07-10 Wrangler (JK) 4-Door

| Part # | QTY |
|---|------------|
| XHD Center Base With Winch Cutout | 11540.10 1 |
| Standard Ends for XHD | 11540.12 1 |
| XHD Rear Bumper | 11546.20 1 |
| Rear 2" Receiver Hitch, JK | 11580.10 1 |
| Receiver Hitch Shackle Bracket | 11234.01 1 |
| Lockable Spare Tire Mount Bike Rack | 11237.10 1 |
| Spare Tire Spacer | 11585.02 1 |
| RRC Side Armor, 4-Door | 11504.20 1 |
| 2.5" ORV™ Lift Kit with Shocks | 18415.50 1 |
| 10,500lb Winch with Steel Cable | 15100.10 1 |
| Roller Fairlead License Plate Holder | 11238.05 1 |
| Satin Black with Machined Lip Wheels for JK | 15301.10 5 |
| Cowl Body Armor | 11651.18 1 |
| Body Armor Corner Guards, 4-Door JK | 11651.01 1 |
| Windshield Light Brackets, Black | 11027.03 1 |
| Slim Light Kit, Black, Pair | 15207.58 1 |
| Front Headlight Euroguards | 11230.03 1 |
| Parking Light Euroguards | 11231.11 1 |
| Side Marker Light Euroguards | 11231.12 1 |
| Grille Inserts, Black | 11306.30 1 |
| Headlight Bezels, Black | 12419.25 1 |
| Rear Euroguards, Black | 11226.02 1 |
| Locking Black Fuel Cover | 11229.03 1 |
| Black Door Recess Guards | 11651.26 1 |
| Padded Arm Rest, Black * | 13107.01 1 |
| Ultimate Grab Handles | 13505.04 1 |
| Rear Side Grab Handles | 13305.14 1 |
| Fire Extinguisher Holder, Roll Bar Mount | 13305.21 1 |
| Interior Trim, Silver * | 11151.96 1 |
| Roll Bar Flashlight Holder | 11205.20 1 |
| Front Seat Protectors, Black | 13235.30 1 |
| Rear Seat Organizer, JK * | 13551.15 1 |
| Dash Organizer/CB Mount * | 13551.10 1 |
| Front All Terrain Floor Liners | 12920.01 1 |
| Rear All Terrain Floor Liners, 4-Door | 12950.01 1 |
| All Terrain Cargo Liner | 12975.01 1 |

Weekend Wild - 07-10 Wrangler (JK) 2-Door

| Part # | QTY |
|---|------------|
| XHD Center Base With Winch Cutout | 11540.10 1 |
| Standard Ends for XHD | 11540.12 1 |
| XHD Rear Bumper | 11546.20 1 |
| Rear 2" Receiver Hitch, JK | 11580.10 1 |
| Receiver Hitch Shackle Bracket | 11234.01 1 |
| Lockable Spare Tire Mount Bike Rack | 11237.10 1 |
| Spare Tire Spacer | 11585.02 1 |
| RRC Side Armor, 4-Door | 11504.20 1 |
| 3.5" ORV™ Lift Kit with Shocks | 18415.50 1 |
| 10,500lb Winch with Steel Cable | 15100.10 1 |
| Roller Fairlead License Plate Holder | 11238.05 1 |
| Satin Black with Machined Lip Wheels for JK | 15301.10 5 |
| Cowl Body Armor | 11651.18 1 |
| Body Armor Corner Guards, 2-Door JK | 11651.01 1 |
| Windshield Light Brackets, Black | 11027.03 1 |
| Slim Light Kit, Black, Pair | 15207.58 1 |
| Front Headlight Euroguards | 11230.03 1 |
| Parking Light Euroguards | 11231.11 1 |
| Side Marker Light Euroguards | 11231.12 1 |
| Grille Inserts, Black | 11306.30 1 |
| Headlight Bezels, Black | 12419.25 1 |
| Rear Euroguards, Black | 11226.02 1 |
| Locking Black Fuel Cover | 11229.03 1 |
| Black Door Recess Guards | 11651.25 1 |
| Padded Arm Rest, Black * | 13107.01 1 |
| Ultimate Grab Handles | 13505.04 1 |
| Fire Extinguisher Holder, Roll Bar Mount | 13305.21 1 |
| Interior Trim, Silver * | 11151.96 1 |
| Roll Bar Flashlight Holder | 11205.20 1 |
| Front Seat Protectors, Black | 13235.30 1 |
| Rear Seat Organizer, JK * | 13551.15 1 |
| Dash Organizer/CB Mount * | 13551.10 1 |
| Front All Terrain Floor Liners | 12920.01 1 |
| Rear All Terrain Floor Liners, 2-Door | 12950.01 1 |
| All Terrain Cargo Liner | 12975.01 1 |

*Fits 2007-2010 Wranglers only. Separate applications available for 2011-2012 vehicles.

XHD MODULAR BUMPER SYSTEM

THE MOST ADVANCED, TOUGHEST, MOST FLEXIBLE BUMPER SYSTEM EVER CREATED!

It's over 100 bumpers in one! You won't find a more versatile bumper system. Go from hardcore to street savvy with just a few hand tools.

Wrangler-07-12

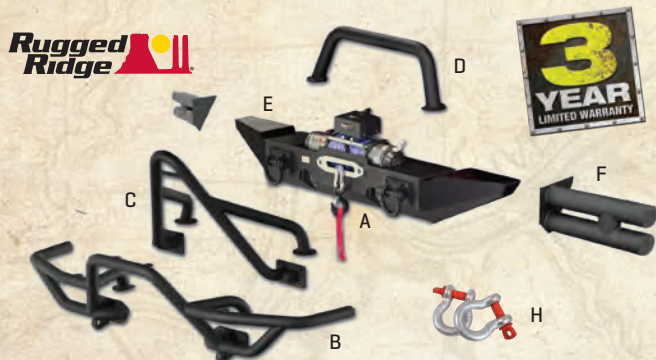

Winch Mount Base - 11540.10
Hoop Over-Rider - 11540.14
Stubby Ends - 11540.23

No other bumper can give your Jeep® this many looks. Modular design provides dozens of different looks and styles. You can build the exact bumper of your choice! Custom designed for the 2007-2012 Jeep® Wranglers, each component maximizes the oversized look of the vehicle. All components are constructed of heavy-duty textured black powder coated steel with a tough E-Coat under-coating or polished, no rust, prime 304 stainless steel for the ultimate look! These tough finishes will provide years of heavy-duty use. Matching rear bumpers are available for a complete look.

Application

| Application | Part # |
|---|----------|
| Short Base, Winch Mount, Textured Black D-Rings, 07-12 Wrangler [A] | 11540.10 |
| Short Base, Light Mount, Textured Black D-Rings, 07-12 Wrangler | 11540.11 |
| RRC Mount, 2.5" Tube, Textured Black for XHD Bumper, 07-12 Wrangler [B] | 11540.18 |
| Stinger, 2" Textured Black for XHD Bumper, 07-12 Wrangler [C] | 11540.13 |
| Hoop Over-Rider, 60mm Textured Black for XHD Bumper, 07-12 Wrangler [D] | 11540.14 |
| Standard Ends, Textured Black for XHD Bumper, 07-12 Wrangler [E] | 11540.12 |
| Storage Ends, Textured Black for XHD Bumper, 07-12 Wrangler* NEW [F] | 11540.22 |
| Tube Ends, Textured Black for XHD Bumper, 07-12 Wrangler NEW [F] | 11540.21 |
| Stubby Ends, Textured Black for XHD Bumper, 07-12 Wrangler NEW [F] | 11540.23 |
| D-Rings, Pair For Use With Stinger & RRC D-Ring Mounts, 07-12 Wrangler [G] | 11235.01 |
| Mounting Plates For Warn Power Plant Winch (for use on 11540.10 XHD Bumper only) | 11540.15 |
| D-Rings, Pair For Use With Bumper Base, 07-12 Wrangler (Included with XHD Bumper base) NEW [H] | 11235.01 |

Storage ends will not work with the [B] RRC front bumper

XHD TUBE ENDS

Add tube ends to your XHD bumper for added protection and a classic OE look! XHD Tube Ends offer wraparound protection and added clearance for oversized tires. Available in either textured black powder coat or polished 304 stainless steel for a long lasting durable finish.



XHD STORAGE ENDS



NEW!

11540.22
Storage Ends,
Black

Looking for an easily accessible yet secure storage solution for your Wrangler? XHD Storage Ends from Rugged Ridge® turn your bumper into a stylish watertight storage vault. The XHD Storage ends are a great place to stow recovery gear and other valuables. Beefy steel construction, a watertight seal, and lockable lid helps keep mud and water out and your gear in.

XHD Tube Ends

| XHD Tube Ends | Part # |
|--|----------|
| Tube Ends, Textured Black for XHD Bumper, 07-12 Wrangler NEW | 11540.21 |
| Tube Ends, Stainless Steel for XHD Bumper, 07-12 Wrangler NEW | 11540.73 |

XHD Storage Ends

| XHD Storage Ends | Part # |
|---|----------|
| Storage Ends, Textured Black, 07-12 Wrangler NEW | 11540.22 |

ALSO AVAILABLE IN STAINLESS FOR A WHOLE NEW LOOK!

Nothing lasts as long or stands up to the elements like stainless steel. Not only do you get a bright shiny finish, but the long lasting durability of prime 304 stainless!

XHD Bumper System (Stainless Steel)

| XHD Bumper System (Stainless Steel) | Part # |
|--|----------|
| Short Base, Light Mount, Stainless Steel, Stainless D-Rings, 07-12 Wrangler* | 11540.71 |
| Hoop Over-Rider, 60mm Stainless for XHD Bumper, 07-12 Wrangler** | 11540.16 |
| Standard Ends, Stainless for XHD Bumper, 07-12 Wrangler Pair | 11540.19 |
| Tube Ends, Stainless for XHD Bumper, 07-12 Wrangler Pair NEW | 11540.73 |
| Polished Stainless D-Rings, Replaces Standard XHD D-Rings, 07-12 Wrangler.Pair | 11540.17 |

* Includes Stainless D-Rings ** Will not work with Warn Power Plant Winch.



Note: XHD Modular Bumper Components Do Not Interchange With XHD Aluminum Bumper Components



XHD ALUMINUM BUMPER SYSTEM



Designed to be a whole new look while being extremely light weight. Save on fuel and the need for front suspension spacers. The Bumper is all Aluminum but uses the current steel XHD D-rings. Each bumper comes with a built in top filler plate. Each new XHD has cutouts and mounting points for the factory fog lights and a great looking "Jeep® Style" front slat look that will make this bumper stand out. If you want to run a winch, simply remove the filler plate and attach the optional JK Winch mounting plate [Steel Plate]. The XHD Aluminum bumper is approximately 80lbs+ lighter than the average steel off road bumper. Government studies show a fuel economy benefit of 2% for every 100lbs of weight savings.**

Available Components:

- Aluminum Center Section with Steel D-Rings
- Stubby Bumper Ends - Aluminum
- JK Winch Plate - Special design for this bumper
- Special Aluminum Over-rider with front slope

** Aluminum XHD Bumper Components do not interchange with Steel XHD Bumper Components

**<http://www.fueleconomy.gov/feg/driveHabits.shtml>

Just How Light is the Aluminum XHD Bumper?

| Front Bumper | Weight |
|--|-------------|
| Aluminum XHD - Standard Configuration* | 26.9lbs |
| OE Bumper | 35.7lbs |
| Brand X Off Road Bumper | 110lbs & Up |

*Standard Configuration: Bumper Base, Filler Plate & D-Rings. The optional Hoop Over-rider, Stubby Ends & Winch Plate make the maximum overall weight of the bumper 62.6lbs.



JK Aluminum Front Bumper,

| | Part # |
|---|----------|
| 07-12 Wrangler Non-Winch, Textured Blk, NEW | 11541.02 |
| 07-12 Wrangler With Winch, Textured Blk, NEW | 11541.01 |
| 07-12 Wrangler Winch Plate, NEW | 11541.13 |
| 07-12 Wrangler Front Bumper Ends, ¹ NEW | 11541.10 |
| 07-12 Wrangler Over Rider, ¹ NEW | 11541.14 |

¹ Not compatible w/ 11540.10 or 11540.11



XHD ALUMINUM REAR BUMPER PODS



Taking the light weight theme further, we have developed steel inner framed Aluminum Rear Bumper Pods. These new lightweight Pods still allow for over sized tires but take a huge chunk of weight out of the bumper. [The picture shows the rear pods installed with the enclosed steel D rings for the XHD Rear Tire Carrier]. Each Pod can be used with tire carrier part #11546.20 to hang those 35"+ tires shown in picture with the optional center step. The XHD Aluminum bumper pods are approximately 40lbs+ lighter than the average steel off road bumper. Government studies show a fuel economy benefit of 2% for every 100lbs of weight savings.**

**<http://www.fueleconomy.gov/feg/driveHabits.shtml>

Just How Light is the Aluminum XHD Rear Bumper?

| Rear Bumper | Weight |
|--|------------|
| Aluminum XHD - Standard Configuration* | 43.45lbs |
| OE Plastic Bumper Cover | 16.5lbs |
| Brand X Off Road Bumper | 85lbs & Up |

*Standard Configuration: Pods, Brackets & D-Rings. The optional Step adds an additional 6lbs.



11547.01

11547.10

*See page J10 for tire carrier option. Part# 11546.20

JK Aluminum Rear Bumper

| | Part # |
|---|----------|
| 07-12 Wrangler XHD Bumper Pods, Textured Blk, NEW | 11547.01 |
| 07-12 Wrangler XHD Bumper Pod Center Step, Textured Blk, NEW | 11547.10 |

All images are subject to be representative. More detailed information is available online.

XHD REAR BUMPER SYSTEM FOR 2007-12 WRANGLER

Make the most of your rear bumper with our XHD Rear Bumper System. Features easy installation, amazing looks and two reinforced heavy-duty D-Ring attachment points. Special "inner mounting plate" provides an extremely secure mounting point - strong enough for off-road use! The two-piece design allows use with and without tire carrier options. Heavy-duty powder coated steel design looks great but is extremely tough. Mount on the optional Tire Carrier and you can hold up to a 35" tire.



D-rings attach securely to the frame of the vehicle for a rock solid recovery mounting point.



Xtreme Heavy-Duty Rear Bumper

| | |
|---|----------|
| Rear XHD Bumper, Textured Black, 07-12 Wrangler | 11546.20 |
| Rear Receiver Hitch, 07-12 Wrangler | 11580.10 |

Part

| |
|----------|
| 11546.20 |
| 11580.10 |

XHD TIRE CARRIER MOUNT FOR 2007-12 WRANGLER

The perfect addition to the XHD Rear Bumper & XHD Aluminum Rear Bumper is the matching XHD Tire Carrier Mount. The latch uses a sturdy locking mechanism for security and a tough appearance. Our engineers have gone to great lengths to make this the quietest tire carrier on the market, no more rattling! The massive hinge pivots on a heavy-duty roller bearing and supports up to a 35" tire. A multi-position locking pin mechanism keeps the arm in the open position when you need to open the tailgate, even on the steepest grade. The XHD Tire Carrier Mount attaches to the XHD Rear Bumpers using the D-ring mounts for a solid foundation.

Latching Mechanism With Attached Security Pin Keeps Your Carrier Secure

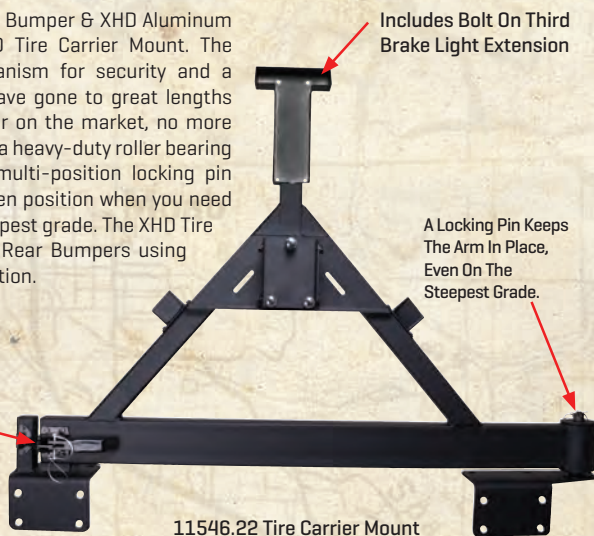

Includes Bolt On Third Brake Light Extension

A Locking Pin Keeps The Arm In Place, Even On The Steepest Grade.

11546.22 Tire Carrier Mount



The Massive Tapered Greasable Dual Roller Bearing Hinge Supports Up To a 35" Tire.

XHD Tire Carrier Mount

| | |
|--|----------|
| Tire Carrier Mount Add-on for 11546.20 & 11547.01, Textured Black 07-12 Wrangler | 11546.22 |
|--|----------|

Part

| |
|----------|
| 11546.22 |
|----------|

TIRE CARRIER LINKAGE

Has opening your rear tailgate become a burden since you added a swing out tire carrier? Has it become easier to crawl over the rear seat to grab your gear, than hassling with the tire carrier? The Rugged Ridge® Tire Carrier Linkage Kit eliminates the issue and makes accessing the cargo area quick and painless. Once installed the linkage mates the tire carrier to the tailgate, so both open in a single fluid movement. The Tire Carrier Linkage is designed to work with Rugged Ridge® XHD, rear bumper and tire carriers, but will also work with most other aftermarket tire carriers. No drilling is required to mount the linkage to the tailgate, but some minor drilling is required to mount the linkage to the tire carrier.

Tire Carrier Linkage

| | |
|--|----------|
| Tire Carrier Linkage, 07-12 Wrangler (JK) NEW | 11503.91 |
|--|----------|

Part

| |
|----------|
| 11503.91 |
|----------|



TIRE CARRIER RECOVERY (TCR) BAG

The TCR bag has been designed to mount to Rugged Ridge® RRC, XHD & Classic rear tire carrier bumpers. This bag allows the storage of all your recovery gear between the A-frame uprights on your rear tire carrier. Constructed of weather resistant material & features a zipper flap to help protect your gear from the environment. Attaches easily with 4 heavy-duty nylon straps that allow for quick removal and transport.

Tire Carrier Recovery Bag (Each)

| | |
|--|----------|
| TCR Bag Fits XHD Rear Bumper with Tire Carrier | 12801.50 |
|--|----------|

Part

| |
|----------|
| 12801.50 |
|----------|



Carries Recovery Gear (not included)



Removable with Handy Carry Handle

REAR TUBE BUMPER FOR 2007-12 JEEP® WRANGLER

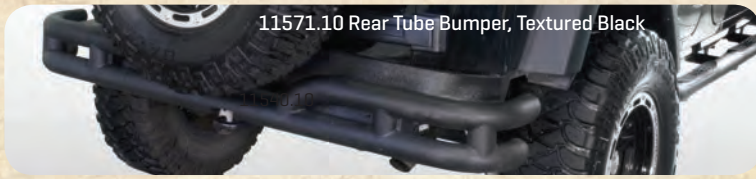

11571.10 Rear Tube Bumper, Textured Black

Get the off-road look with a Rugged Ridge® Tube Bumper! Each bumper has smooth ground welds, welded end caps (not plastic end caps!) and the unique style only available from Rugged Ridge®. Center tire cut-out allows for larger tires while still keeping that off-road look, accommodates tire sizes up to 35". Each rear tube bumper includes a special UV treated textured plastic filler plate to fill in the gap between the body and the bumper, a Rugged Ridge® exclusive.



Welded end caps, not plastic!



Textured plastic filler plate fills in the gap between the body and the bumper, a Rugged Ridge® exclusive.

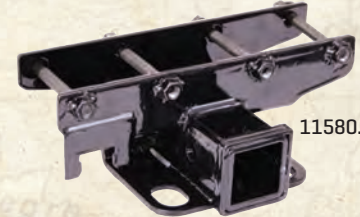

11580.10

| Rear Tube Bumper | Textured Black | Stainless |
|----------------------------------|----------------|-----------|
| Rear Tube Bumper, 07-12 Wrangler | 11571.10 | 11573.10 |

| Rear Receiver Hitch | Part # |
|---|----------|
| Rear Receiver Hitch, 07-12 Wrangler | 11580.10 |
| Rear Receiver Hitch with OE Style Wiring Harness, 07-12 Wrangler NEW | 11580.51 |

The Rugged Ridge® RRC Rear Bumper provides the off road protection you are looking for! The frame mounted platform features a heavy-duty grid like system with raised sides for the ultimate protection and greatest ground clearance. Each RRC bumper is constructed of durable powder coat painted .120 wall welded end cap steel tubing for long life and extreme durability. RRC Rear Bumper also features a reinforced hitch box that is designed for off-road accessories (not designed or rated for towing. Use only for accessories). To make your vehicle look its very best, we have enclosed a rear filler plate that completes the look of your bumper and hides un-sightly under carriage parts.

RRC REAR BUMPERS



11503.15 RRC Bumper with Hitch for 07-12 Wrangler



| RRC Rear Bumpers | Textured Black |
|--|----------------|
| 07-12 Wrangler, RRC Rear Bumper w/Hitch Each | 11503.15 |

CAUTION: Receiver not designed or rated for towing. Use only for accessories (bike rack, etc.)



11586.01

OFF ROAD JACK MOUNT

JK Off-Road Jack Mount allows you to carry your Off-Road jack on the outside of your vehicle saving precious cargo space. Fast and easy bolt on installation. Compatible with stock and most aftermarket rear bumpers (without tire carriers) as well as Rugged Ridge® XHD rear bumper with or without tire carrier. Bracket is sturdy and secures the jack in two locations to eliminate any vibration noise during vehicle operation. Durable textured finish looks great. Fits most off-road style jacks including Hi-Lift™.

Each Jack mount incorporates a special round cutout for padlock use.

Quick Release Knob Allows For Easy Jack Attachment/Removal



NEW!

Fits All Original Equipment And Rugged Ridge® XHD Rear Bumpers

| Off Road Jack Mount | Part # |
|--|----------|
| Off Road Jack Mounting Bracket, Hi-Lift Style, Jeep® Wrangler 07-12, Pair NEW | 11586.01 |



11503.89

CB ANTENNA MOUNT

Easily and quickly install your CB antenna to your Jeep® with the new Rugged Ridge® spare tire carrier mount antenna mount. This durable mounting bracket installs directly to factory tire carrier on 2007-current Jeep® Wranglers without drilling. Each powder coat painted textured black steel bracket is extremely durable and provides a hidden mounting point for your CB or off road antenna. Each antenna mount includes mounting hardware and bracket.

| Spare Tire Carrier CB Antenna Mount | Part # |
|---|----------|
| Spare Tire Carrier CB Antenna Mount, 07-12 Wrangler, NEW | 11503.89 |

All images are subject to be representative. More detailed information is available online.

FRONT TUBE BUMPERS FOR 2007-12 WRANGLERS
2007-12 WRANGLER DESIGN

Wrangler 07-12

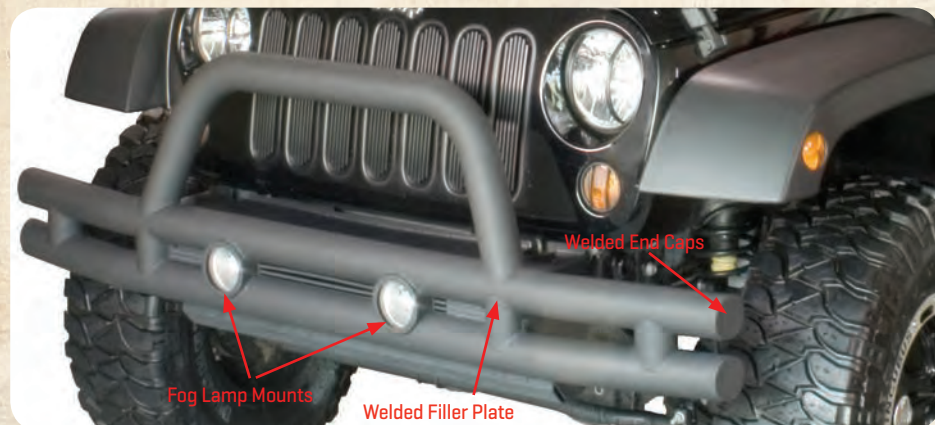

11561.10 Front Bumper, Textured Black w/ Winch Cut-Out, 07-12 Wrangler

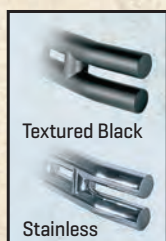

| Front Bumpers | Front Bumper with Riser | Black | Textured Black | Stainless |
|----------------------|--------------------------------------|----------|----------------|-----------|
| 07-12 Wrangler * | Front Tube Bumper w/Riser | - | 11561.10 | 11563.10 |
| 07-12 Wrangler * [1] | Front Bumper w/ Built-in Winch Plate | - | 11561.11 | - |
| For All Tube Bumpers | License Plate Mounting Bracket | 11503.80 | - | - |
| For All Tube Bumpers | Light Mounting Bracket Each | 11503.81 | - | - |
| For All Tube Bumpers | CB Antenna Mounting Bracket Each | 11503.88 | - | - |

* Fits 2 & 4-Door. 2007-12 Wrangler, has cut-outs for OE foglamps. [1] Winch mount plate included.

JK STUBBY TUBE BUMPER

Rugged Ridge® has taken their industry leading Front Tube Bumper and re-designed the ends to make the ultimate high clearance off-road winch bumper. This unique design has a built-in winch mount and special cut-outs for the JK Wrangler factory fog lamps. Like our regular tube bumper, we have cut into the front tubing allowing the bumper to "hug" the front end of the Jeep®. Each bumper includes durable welded end caps and polished smooth welds for the ultimate in durability. NEW: Special inside pre-coat eliminates any chance of interior rusting. A Rugged Ridge® Exclusive!



NEW!

| Stubby Tube Bumper | Part # |
|---|----------|
| Stubby Tube Bumper, 07-12 Wrangler (JK) Each NEW | 11561.12 |

BULL BARS FOR 07-12 WRANGLER

Get that heavy-duty look with a Bull Bar from Rugged Ridge®! Each design has been custom designed for your JK Wrangler utilizing tough 3/8"-1/4" thick heavy-duty mounting brackets. Each Bull Bar offers smooth ground welds and laser cut skid plates. The black model has a dual stage powder coat finish with a tough E-coat under coating. The polished stainless version has been polished to a mirror finish providing a beautiful look on your Jeep®.

Pre-drilled light tabs for off-road light mounting.

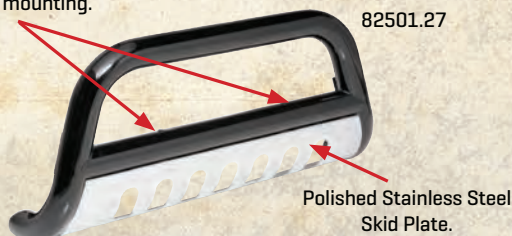

| Bull Bars For 07-12 Wrangler | Part # |
|---------------------------------|----------|
| 3 Inch Black Powder Coated Each | 82001.27 |
| 3 Inch Stainless Steel Each | 82501.27 |

BUMPER APPLIQUÉS

Make your NEW Wrangler look like a Sahara model with this beautiful new Rear Bumper Appliqué from Rugged Ridge®. Constructed of impact resistant polymers, this custom fit appliqué will dress up the front of your original equipment bumper easily and quickly. Installing with screws to the back of your bumper (just like original equipment!), this appliqué is a quick up-grade or an inexpensive replacement.



NEW!

Matches OE Sahara Finish!

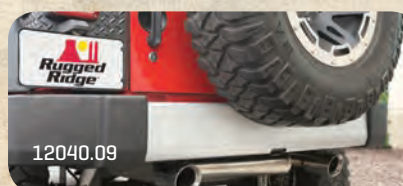

| Bumper Appliqués | Part # |
|---|----------|
| Bumper Applique, Front, Silver, Jeep® Wrangler (JK) 07-10 | 12040.08 |
| Bumper Applique, Rear, Silver, Jeep® Wrangler (JK) 07-10 | 12040.09 |

RRC SIDE ARMOR



2" x .12" Wall Construction, Black Texture Powder Coat Finish

Resists Scratches & Is Slip Resistant

11054.20 RRC Side Armor, Textured Black, 07-12 4-Door Wrangler

Keep your rocker panels from being beaten to a pulp on the trail with Rugged Ridge® Side Armor. Built from heavy-duty 2" x 0.120" black texture powder coated steel tubing, these guards will take the beating that was meant for your sheet metal. JK models feature a simple bolt-on design that utilizes existing body mount locations for a secure, rattle free installation. The black texture finish resists scratches and gives a slip-resistant surface for door entry. Sold as a pair and includes all necessary installation hardware.



07-12 Wrangler models have simple bolt on design. Utilizes existing body mount locations on frame.

| RRC Side Armor | Textured Black |
|-----------------------------|----------------|
| 07-12 Wrangler, 4-Door Pair | 11504.20 |
| 07-12 Wrangler, 2-Door Pair | 11504.21 |

RRC ROCK SLIDERS



11504.23 RRC Rock Slider, Textured Black, 07-12 2-Door Wrangler

This true Rock Crawling design puts protection tight up under the side of your Jeep® while adding a special side "hoop" to block those large outcroppings. Special no drill frame mounted design provides secure, bounce-free installation while keeping the mounting points above the bottom of the frame for greater ground clearance. Each RRC Rock slider mounts to your Wrangler using a simple bolt on frame mount design for ease of installation and extra durability.



11504.22 RRC Rock Slider, Textured Black, 07-12 4-Door Wrangler

| RRC Rocker Guards | Textured Black |
|----------------------------|----------------|
| 07-12 Wrangler 4-Door Pair | 11504.22 |
| 07-12 Wrangler 2-Door Pair | 11504.23 |

All images are subject to be representative. More detailed information is available online.

SIDE TUBE STEPS

Complete the look with a set of Rugged Ridge® tubular tough duty side steps. Available in 3" round, 4" round, and 4.25" oval diameter sizes. The large 4.25" oval and 4" round tubes provide a much cleaner look and are not "dwarfed" by oversized tires and oversized body style features of the 2007-12 Wrangler. Rugged Ridge® Stainless Steel Tube Steps feature prime 304L, .05" wall stainless tubing polished to a mirror finish. The polishing process for a Rugged Ridge® step is longer and deeper pulling out the deepest shine from the steel. A true "deep polish"! Rugged Ridge® painted steel Tube Steps feature special E-coated, .07" wall steel that is "thick source" powder coated for a tough chip resistant finish. The special E-coat undercoating provides double rust protection as it bonds to the metal creating a protective layer found nowhere else. All Rugged Ridge® Tube steps feature a truly custom fit with installation brackets constructed of durable 3/16" powder coated steel for long life and years of flex-free use. Each Tube Step features special UV treated no-slip step pads with 5 mounting pins. These step pads are preinstalled on top of the tube - no exposed metal to rust. All 2007-12 Wrangler models are no drill designs.

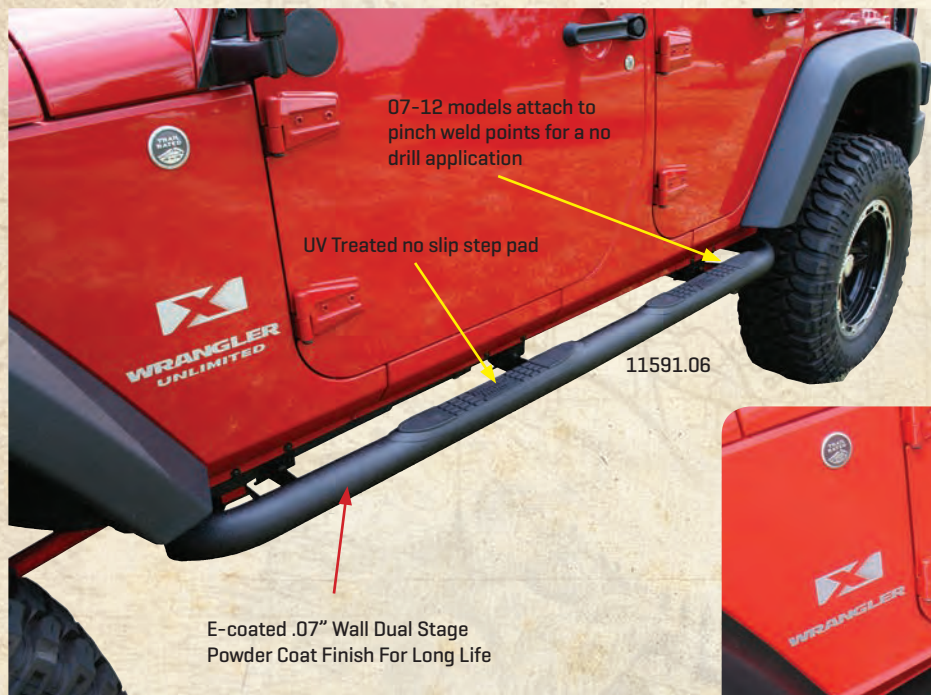

Side Tube Steps

| | Black | Textured Black | Stainless |
|---|----------|----------------|-----------|
| 07-12 Wrangler 3" Round, 2-Door Pair | 11590.05 | 11591.05 | 11593.05 |
| 07-12 Wrangler 3" Round, 4-Door Pair | 11590.06 | 11591.06 | 11593.06 |
| 07-12 Wrangler 4" Round, 2-Door Pair | - | - | 11593.09 |
| 07-12 Wrangler 4" Round, 4-Door Pair | - | - | 11593.10 |
| 07-12 Wrangler 4 1/4" Oval, 2-Door Pair | - | 11591.07 | 11593.07 |
| 07-12 Wrangler 4 1/4" Oval, 4-Door Pair | - | 11591.08 | 11593.08 |

ALL-TERRAIN FLAT FENDER FLARES

Now, with the NEW All-Terrain Flat Fender Flares from Rugged Ridge® you can add a bigger tire option for a true off road look. You can also use in combination with a suspension lift for maximum off road performance. These exciting new flares are out-of-the-box ready to turn your street Jeep® into an off road machine. By removing your original flares and replacing them with these high clearance designs, you can run larger tires without interference from the flare. The ability to run a larger tire with little or no suspension lift means a "lower center of gravity" making your JK more stable, yet you still get greater ground clearance necessary for off road. With 1.5 inches less coverage in the front and 1 inch less in the rear these flares are slightly narrower than factory, yet still maintain proper tire coverage and aggressive looks. Constructed of a flexible UV treated high impact thermoplastic, these flares are designed for the trail and create a whole new look for your JK. Easy to install, these flares replace your factory flares, attaching to the factory mounting points with no drilling. Simply remove your original flares and add on the All Terrain flares. The kit also includes easy to install mounting brackets that allow you to relocate and use the existing factory side marker lights. The All Terrain Flat Fender Flare is the hottest looking, most functional Off Road Flare available for your JK! Finally, because no cutting or drilling is required, if you ever want to switch back to your original factory flares, there's no problem!



Special side marker light brackets included for use with your factory side marker light



All Terrain Flat Fender Flare Kit

| | Part # |
|---|----------|
| Flat Fender Flare Kit, 07-12 Wrangler 2 and 4-Door, 4 Pcs. NEW | 11620.10 |
| Flat Fender Flare & Liner Kit, 2007-12 Wrangler, 8 Pcs. NEW | 11620.11 |

*includes side marker light relocation brackets

ALL TERRAIN FLAT FLARE WHEEL LINER KIT

Designed for use in combination with the Rugged Ridge All Terrain Flat Flares for JK, PN: 11620.10, these wheel well liners help keep mud and debris out of the engine compartment and provide a clean finished look. Constructed from durable HDPE, the wheel liners replace the factory wheel well liners that must be removed when running aftermarket flares. Simple bolt in installation, no cutting or drilling required. Kit includes all four wheel well liners and mounting hardware.



Flare Wheel Liner Kit

| | Part # |
|-------------------------------------|----------|
| 2007-12 Wrangler, 4 Pcs. NEW | 11620.50 |

REPLACEMENT FENDER FLARE KITS

Rugged Ridge® provides the most comprehensive replacement Fender Flare program on the market today. Rugged Ridge® has you covered when it is time to replace or upgrade your Factory Fender Flares. Each Flare is constructed of virtually indestructible, durable, UV treated thermoplastic to provide years of service. Each replacement flare is designed to fit into your factory mounting holes for ease of installation. Just need to replace one flare? No problem. Rugged Ridge® offers individual replacements to keep your investment to a minimum.



Fender Flare Kits

| | Complete Kit 4-pc kit w/out hardware | Front Passenger | Front Driver | Rear Passenger | Rear Driver |
|-----------------|--------------------------------------|-----------------|--------------|----------------|-------------|
| 07-12 Wrangler* | 11609.01 | 11609.10 | 11609.11 | 11609.12 | 11609.13 |

*Except Sahara

All images are subject to be representative. More detailed information is available online.

Wheels For 2007-12 Wrangler



15301.10 Satin Black with Machined Lip



15301.01 Satin Black



15301.40 Silver



15301.20 Chrome



15301.10

Rugged Ridge® is proud to introduce the toughest new design in custom wheels for 2007-12 Wrangler. This Hub-Centric design exactly centers the wheel over the hub providing proper balance, clearance for brake rotors, steering components and suspension. Better fit, no wheel vibration! Stainless steel button-head socket cap screws around the perimeter of the outer wheel face give a great 3-piece look, and also let you accessorize with our optional trim ring. Each wheel includes a UV-treated polished center cap that replicates a manual hub for that off road look. Available in five finishes: Satin Black Powdercoated, Satin Black Powdercoated with Machined Lip, Silver Powdercoated, Dual-Stage Polished Chrome, and Limited Edition Hyper Silver. The durable powdercoated finish gives an ultra-hard finish for long life and a great look. The chrome finish uses a dual-stage process to give a deep reflective mirror-like shine that commands attention. Rugged Ridge® wheels have been independently tested and certified to meet/exceed SAE J2530 standards for wheel strength and durability. Limited lifetime structural warranty and 1 year finish warranty [see warranty information for details and limitations].



Rugged Ridge® Aluminum Wheels for 07-12 Wrangler

| | Part # |
|--|----------|
| Rugged Ridge® Wheel, 17"x9", 12mm Offset, 4.625" Backspacing, Satin Black | 15301.01 |
| Rugged Ridge® Wheel, 17"x9", 12mm Offset, 4.625" Backspacing, Satin Black w/Machined Lip | 15301.10 |
| Rugged Ridge® Wheel, 17"x9", 12mm Offset, 4.625" Backspacing, Silver | 15301.40 |
| Rugged Ridge® Wheel, 17"x9", 12mm Offset, 4.625" Backspacing, Chrome | 15301.20 |
| Center Cap, Replacement Part for 17"x9" Aluminum Rugged Ridge® Wheel | 15201.50 |



15301.20

STEEL D-WINDOW WHEELS



Legendary looks, brutally epic strength. Each Rugged Ridge® steel wheel is stamped from heavy gauge steel and powder coated with a durable black finish. Our wheels have been engineered, tested and certified to meet and exceed the strenuous SAE J2530 standards for wheel strength and durability. Turning a million cycles at double their load capacity to ensure they could hold up the abuses of off road use. Because a Jeep® isn't a Jeep® until its lifted and outfitted with oversized tires. All Rugged Ridge® Steel D Window wheels include a FREE polished center cap!

Steel D-Window Wheels

| | Part # |
|--|----------|
| 07-12 Wrangler, Black, 17X9, 5 on 5 Bolt pattern, 4.5 Backspacing NEW | 15500.70 |

RIM PROTECTORS

Trim rings are available in either Satin Black Powdercoated or Polished Stainless Steel. These trim rings are a great way to protect the wheel lip and tire bead. They also allow you to change the look of your wheels with just a few bolts. For use with Rugged Ridge® wheels only.



15250.02 Rim Protector
Satin Black for 17"x9" Wheel

Rugged Ridge® Rim Protectors for Rugged Ridge® Wheels Only

| | Part # |
|---|----------|
| 07-12 Wrangler, Rugged Ridge® Rim Protector, 17"x9", Polished Stainless Steel * | 15250.01 |
| 07-12 Wrangler, Rugged Ridge® Rim Protector, 17"x9", Satin Black * | 15250.02 |

* Will not fit 15301.20

WHEEL SPACER & ADAPTOR KITS



15201.05



15201.07



15201.06

These hub centric spacers / adapters move your wheels out to help fit wider tires and give your vehicle a wider track and improve stability. Constructed of double anodized black extra thick 6061T6 aluminum for long life and extra corrosion resistance. All hardware is grade-8 for extra strength. Each part number comes as a spacer pair. Included are 10 pre-installed grade-8 wheel studs and 10 lug nuts.

Wheel Spacer Kit

| | | Part # |
|-------------------------|----------------|----------|
| 07-12 Wrangler, Pair | 1.5" Spacer | 15201.05 |
| 07-12 Wrangler, Pair * | 1.375" Adapter | 15201.06 |
| 07-12 Wrangler, Pair ** | 1.375" Adapter | 15201.07 |

* converting 5 on 5" to 5 on 4.5" bolt pattern
** converting 5 on 5" to 5 on 5.5" bolt pattern

CAUTION!

CAUTION: Rugged Ridge® recommends use of wheel spacers with all suspension lifts to reduce risk of roll over or other accident associated with modifying ride height for increased off road capabilities. See additional product safety information and WARNINGS at back of catalog.

All images are subject to be representative. More detailed information is available online.

NEW POWER TOP

BY RUGGED RIDGE®

The first true convertible top for 07-12 Wranglers



POWER TOP AUTOMATICALLY GOES UP AND DOWN WITH THE PUSH OF A BUTTON!



Rugged Ridge® is excited to announce the first ever true convertible top for the 4 door JK Jeep® Wrangler. No more struggling to get your soft top up and down. This revolutionary soft top design automatically goes up and down without you even getting out of the vehicle. Our patent pending design allows the top to be lowered or raised in seconds by unlatching two header latches and the simple push of a button! In development for over a year, the engineers at Rugged Ridge® have created a heavy duty frame system that folds up and over your factory roll bar therefore making the "push button" design possible. The Power Top Kit fits all 2007-2012 four door Wranglers and comes complete with heavy duty sailcloth fabric, 31% tint 30 mil rear window glass, power top frame, hydraulics, wiring harness and an in-depth installation packet. Everything you need to make your JK a true convertible top!

NEW!



Each Power top is a complete kit that includes everything you need for installation to your 2007-2012 four door Wrangler: heavy duty sailcloth fabric, 31% tint 30 mil rear window glass, power top frame, hydraulics, motor, wiring harness and an in-depth installation packet. Bolt-on installation, No fabrication necessary.



WARNING:

Loss of vehicle control involves risk of death or serious injury, particularly to parts of your body not restrained within vehicle. This product is intended for weather protection only and should not be relied upon to contain occupants in the event of an accident or to protect from either ground contact or falling objects. To reduce risk of accident injury:
 Always wear seat belts.
 Read and follow all instructions and warnings accompanying this product, in vehicle owners manual and Off Road Driving Supplement.



LOOK AT THESE EXCLUSIVE FEATURES:

- The kit has everything needed for a complete installation including the soft top, frame, door surrounds, motor, hydraulics and wiring. Installation requires that you reuse the factory header and rear tailgate bar. One kit fits all years of 4 door Wrangler!
- Professional installation is recommended but a skilled do it yourselfer can also install it and no special tools are required. **Estimated install time for a skilled installer is approximately 5 hours.**
- The [patent pending] 4 door version will be available first but we also have a 2 door version in development.
- The frame comes pre-assembled and ready for installation and is constructed from corrosion resistant powder coated steel. All fasteners and bushing are specified for high grade strength and wear resistance.
- The frame installs to the tub rail using pre-existing holes along the top and then one hole is required over either wheel well on both sides to provide added support for strength, rigidity and smooth operation.
- Injection molded door surrounds are included to replace the factory surrounds to ensure a weather tight seal.
- The frame is powered by an electric motor with a hydraulic pump that drives two hydraulic cylinders. The motor and wiring relays mounts underneath the rear deck lid where it is concealed neatly out of the way.
- The motor and hydraulic cylinders come pre-assembled and ready to install with adjustable flow control valve, hoses, fittings and fluid [pre-bled].
- The top is constructed from premium sail cloth fabric and includes a zip-out removable DOT approved 30 mil rear window with 31% smoke tint.
- The system includes all wiring, relays, and switches for a complete installation. The wiring scheme is a simple yet very effective design and protects against improper operation or damage of the top by only working when the drivers' foot is on the brake.
- Limit switches are also included to control the power when the top is either fully up or fully down for added safety and to reduce wear and stress on the system.
- Operation of the top is extremely easy and effortless. From the driver's seat you simply unlatch the header and [while your foot is on the brake and key in ignition] push the switch. Down it goes! That's it!
- The power top is designed to stay on the vehicle full time once it is installed. However, it can also be removed from time to time if necessary thus permitting the owner to change it over to their hard top in winter or to return the vehicle to a factory style top.
- Service and replacement parts will be readily available.
- The entire system and all components are covered by our 3 year warranty.



A durable hydraulic piston provides the torque to lift and retract the Power Top. Easily secured to the vehicle wheel well and soft top frame, this durable component has been cycle tested to ensure a long life and consistent performance.



The Name Power Top comes from a durable electric power plant that has been specially developed for strength and size. This heavy duty motor installs in the storage compartment in the rear of your Jeep® keeping the rear cargo area clutter free. Each Power top includes the necessary wiring harness to make installation as easy as possible.



All Power tops have a tinted rear window that either rolls up or can be completely zipped out. This allows for that open air experience that Jeep® owners love! All Window glass is extra thick 30mil DOT approved with 31% tint. Quality and superior function all in one!

Power Top

Power Top Kit, Black Sail Cloth, Jeep® Wrangler [JK] 4-Door 2007-2012

* 2 Door JK is planned for 2012 introduction

Part#

19515.01

All images are subject to be representative. More detailed information is available online.

XHD FABRIC REPLACEMENT SOFT TOPS

Rugged Ridge® soft tops use only the finest vinyl coated polyester & sailcloth fabrics on all their tops. Each fabric color is specially formulated to match the original equipment colored top to make your Jeep® look like it came off the show room floor. These fabric only soft tops are designed to fit over your original factory hardware

NEW!

Wrangler 07-12



Fabric Replacement Tops for JK

| | Diamond Black | Diamond Khaki |
|---|---------------|---------------|
| Without Door Skins, Jeep® Wrangler [JK] 07-09 2-Door NEW | 13736.35 | 13736.36 |
| Without Door Skins, Jeep® Wrangler [JK] 07-09 4-Door NEW | 13741.35 | 13741.36 |

Sailcloth Fabric Replacement Tops for JK

| | Black Diamond | |
|---|---------------|---|
| Sailcloth, With Tinted Windows, Without Door Skins, Jeep® Wrangler [JK] 07-09 2-Door NEW | 13736.01 | - |
| Sailcloth, With Tinted Windows, Without Door Skins, Jeep® Wrangler [JK] 07-09 4-Door NEW | 13741.01 | - |

POCKET BRIEFS

Tired of papers and other small items flying around the cab of your Jeep® when using your Summer Brief? Introducing the most innovative new addition to a Summer Brief in over 50 years the Pocket Brief from Rugged Ridge®! This revolutionary design incorporates two mesh zippered corner pockets directly over the driver and passenger creating much needed storage space. Special two sided mesh and nylon "pocket" seals shut with a reinforced zipper, keeps small items secure even in most severe conditions. Built directly into the Rugged Ridge® Summer Brief to ensure a clean, tight fit. Constructed of durable soft top fabric for long life. Available in matching soft top colors to give your Jeep® a finished look.



NEW!



Pocket Brief

| | Diamond Black | Diamond Khaki |
|--|---------------|---------------|
| Pocket Brief 07-09 Wrangler, 2-Door & 4-Door* | 13587.35 | 13587.36 |
| Pocket Brief 10-12 Wrangler, 2-Door & 4-Door* NEW | 13590.35 | 13590.36 |

* Requires a separate Windshield Header (#13308.05) for installation

MESH SUMMER BRIEFS/ISLAND TOPPERS™



Mesh Summer Briefs Include Corner Pockets

Special UV treated mesh fabric blocks the heat while allowing the cool breeze to flow through. The special weave of the Rugged Ridge® mesh brief/Island Topper is designed for strength and durability while providing open air protection from the sun's heat. Available in two great styles: the Summer Brief that goes to the center hoop and the "Island Topper" that goes back to cover those rear seat passengers. Don't forget the Header/Windshield channel needed to install these tops!

Mesh Summer Briefs/Island Topper™

| | Part # |
|--|----------|
| Mesh Summer Brief, 07-09 Wrangler 2-Door, Each * | 13579.02 |
| Mesh Summer Brief, 10-12 Wrangler 2-Door, Each* NEW | 13579.12 |
| Mesh Summer Island Topper, 07-09 Wrangler 2-Door, Each * | 13579.01 |
| Mesh Summer Island Topper, 10-12 Wrangler 2-Door, Each* NEW | 13579.11 |
| Mesh Summer Island Topper, 07-09 Wrangler 4-Door, Each * | 13579.03 |
| Mesh Summer Island Topper, 10-12 Wrangler 4-Door, Each* NEW | 13579.13 |

* Requires a separate Windshield Header (#13308.05) for installation

POCKET ISLAND TOPPERS™



13588.35 Island Topper, Diamond Black, 07-09 Wrangler



NEW!

Pocket Island Toppers feature zippered pockets to securely stow away important items like cell phones, maps and sunglasses.

The most advanced summer soft top solution found on the market today, the new Pocket Island Topper! This new design features tough diamond fabric combined with a pair of zipper front pockets for the ultimate full featured top. Unlike other summer tops on the market, the Rugged Ridge® design features wider side hook and loop fastener straps, a reinforced front section and extra heavy duty nylon tie down straps.

| Pocket Island Toppers | Diamond Black | Diamond Khaki |
|-------------------------------------|---------------|---------------|
| 10-12 Wrangler, 2-Door * NEW | 13591.35 | 13591.36 |
| 10-12 Wrangler, 4-Door * NEW | 13592.35 | 13592.36 |
| 07-09 Wrangler, 2-Door * | 13588.35 | 13588.36 |
| 07-09 Wrangler, 4-Door * | 13589.35 | 13589.36 |

* Requires a separate Windshield Header (#13308.06) for installation

WINDSHIELD HEADERS

These upgraded preassembled windshield headers installs quickly and easily! Just attach your Brief/Island Topper and place the header channel on the top of your windshield, slide the clamps onto the supplied knobs and clamp the channel in place. That's it! The channel is now securely held in place and ready for summer wheeling. No drilling or modifications required! Note: Will work with Bestop and other aftermarket summer tops. No Drill Windshield Header required for installation of Pocket Briefs and Island Toppers on all 07-12 Wranglers.



NEW!



Dual Bumper Tabs Provide Extra Support

Special Foam Top Provides The Best Look On Your JK.

Easy, No Drill Design. Simple One Minute Assembly!

13308.05 Windshield Header for 07-12 Wrangler

Header Attaches with Only 2 Knobs

| Windshield Header | Part # |
|---|----------|
| 07-12 Wrangler, Extruded Aluminum, 2 & 4-Door | 13308.05 |
| 07-12 Wrangler, Deluxe, 2 & 4-Door, Stamped Steel* NEW | 13308.06 |

*For use with Summer Briefs, Island Toppers and all other brands of summer tops

WARNING: Loss of vehicle control involves risk of death or serious injury, particularly to parts of your body not restrained within vehicle. This product is intended for weather protection only and should not be relied upon to contain occupants in the event of an accident or to protect from either ground contact or falling objects. To reduce risk of accident injury:

- Always wear seat belts.
- Read and follow all instructions and warnings accompanying this product, in vehicle owners manual and Off Road Driving Supplement.

All images are subject to be representative. More detailed information is available online.

WINDOW STORAGE ROLL BAG

Protect your soft top windows from scratching and other damage with a window storage bag from Rugged Ridge®. This easy to use storage bag stores your rear quarter and rear back window using a soft internal material and a heavy duty exterior fabric bag for the ultimate in protection. The internal fabric is placed between the windows to prevent scratching and window on window contact. Simply place the windows in between the fabric and gently roll the windows into an easy to store "window roll". This rolled up bag can now be easily installed to the rear of your sport bar with attached nylon straps and buckles. This window storage bag solution is a must for those soft top owners who want to keep their windows out of harm's way and prolong the life of their soft top. Each storage bag is backed by an industry leading 3 year limited warranty.



| Window Storage Sport Bar Bag | Part # |
|---|----------|
| Black, Jeep® Wrangler (JK) 07-12, 2-Door or 4-Door NEW | 12107.05 |



JK SOFT TOP STORAGE BOOT

Want to cruise around with the top off, but keep your top close in case of sudden showers or temperature drops? The Rugged Ridge® Soft Top Storage Boot is the solution to protect your soft top when it is folded down. Designed to be used with the windows zipped out.

| JK Soft Top Storage Boot | Part # |
|--|----------|
| 07-12 Wrangler 2-Door, Black Diamond, Each | 12104.50 |
| 07-12 Wrangler 4-Door, Black Diamond, Each | 12104.51 |

SOFT TOP DISCONNECTS

Upgrade your factory 2007-12 Wrangler Soft Top Hardware with these quick release bow mounts. Allows for easy, no tool disconnect of your soft top bows from your Jeep®. Installation is easy and quick, no drilling required.



| Soft Top Disconnect Kit | Part # |
|-------------------------------|----------|
| 07-12 Wrangler 4-Door, 4 pack | 11251.04 |

TIRE COVERS

Custom designed to fit today's most popular sized tires. Constructed of durable vinyl coated polyester fabric. Colors match other Rugged Ridge® Soft Accessories. Please measure tire diameter.



| Tire Diameter | Black | Diamond Black | Diamond Khaki |
|---------------|----------|---------------|---------------|
| 27-29" | 12801.01 | 12801.35 | 12801.36 |
| 30-32" | 12802.01 | 12802.35 | 12802.36 |
| 33" | - | 12803.35 | - |
| 35-36" | - | 12804.35 | - |



Note: To ensure proper fit, measure the diameter of the tire you are covering and pick the appropriate tire cover size listed above.

HARD TOP SOUND DEADENER/INSULATION FOR 2007-12 WRANGLER

If you chose the Hard Top option for your 07-12 Wrangler then you need Rugged Ridge®'s Sound Deadener. This insulation is custom fit for the factory multi-piece hard top and greatly reduces noise inside your vehicle. The special insulation material is surrounded by heavy duty pleated nylon providing added interior comfort by insulating the cab from heat and cold. A no drill installation with durable hook and loop fasteners allows for an easy installation without removing your hard top.



Sound Deadener for 07-12 Wrangler Hard Top

| | Part # |
|--|----------|
| 07-10 Wrangler 2-Door, 3 pcs. NEW | 12109.01 |
| 07-10 Wrangler 4-Door, 4 pcs. NEW | 12109.02 |
| 11-12 Wrangler 2-Door, 3 pcs. NEW | 12109.03 |
| 11-12 Wrangler 4-Door, 4 pcs. NEW | 12109.04 |



WATER RESISTANT CAB/FULL COVERS

Custom fit Cab Covers protect your vehicles interior from dust, dirt and light showers. Constructed of vinyl coated polyester fabric or a space age cover material [Weather Lite/Three Layer Covers], these easy to use covers install in minutes. Reinforced elastic side straps and under body hooks hold the cab cover in place. No drilling required. Complete vehicle covers also available in breathable Weather Lite fabric or durable Three Layer Fabric. Weather Lite is perfect for inside storage while the Three Layer covers are designed for short term outdoor use.

3 LAYER PROTECTION!

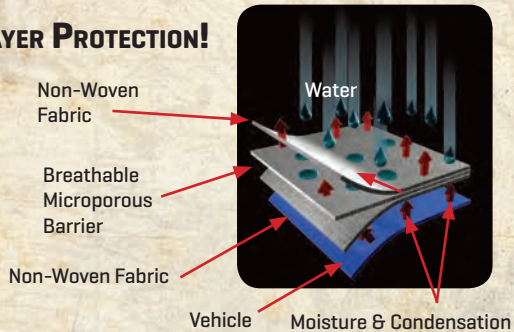

Full Covers

| | Part # |
|--|----------|
| Three Layer Full Car Cover (w/Bag & Lock) 07-12 4-Door Wrangler | 13321.73 |
| Three Layer Full Car Cover (Cover only) 07-12 4-Door Wrangler | 13321.71 |
| Three Layer Full Car Cover (w/Bag & Lock), 07-12 2-Door Wrangler | 13321.81 |
| Three Layer Full Car Cover (Cover only), 07-12 2-Door Wrangler | 13321.80 |
| Car Cover Storage Bag | 12105.01 |
| Cab Cover, Weather Lite, 07-12 2-Door Wrangler NEW | 13317.10 |
| Cab Cover, Weather Lite, 07-12 4-Door Wrangler NEW | 13318.10 |
| Cab Cover, Vinyl, 07-12 2-Door Wrangler NEW | 13317.09 |
| Cab Cover, Vinyl, 07-12 4-Door Wrangler NEW | 13318.09 |



Complete Cover kits with lock and storage bag available.

All images are subject to be representative. More detailed information is available online.

RUGGED RIDGE® ALL TERRAIN FLOOR LINERS FOR 07-12 WRANGLER

The only floor liner with patented "Deep Tread" Technology!

These floor liners are a totally new concept that combines all the best features of a deep rib floor mat and the 'old style' liners. Precision engineering using state of the art technology ensures an exact fit to the shape and contour of your vehicle's floor. The deeply molded Chevron-shape tread pattern channels dirt, mud and snow away from the driver to keep shoes and pant legs clean. It also contains the movement and sloshing around of any trapped water. The high perimeter wall offers a large footprint and maximum interior protection and containment. Unlike ordinary liners that utilize an inconsistent vacuum thermoform process and slippery lower grade plastic these liners are high pressure injection molded from OE-quality Thermoplastic that looks and feels like rubber and provides a nonslip surface. Raised ribs on the bottom provide maximum retention and keep the liner in place. The unique self-sealing floor hook attachment feature helps to prevent dirt and moisture from getting through. Easy to remove and clean. Simply hose them off and go!!! The mat actually reseals itself around the hook!!! Patent D627285.

| Rugged Ridge® Floor Liners & Cargo Liners | Part # |
|--|----------|
| Floor Liner, Front, 2 and 4-Door 07-12 Wrangler, Pair | 12920.01 |
| Floor Liner, Rear, 4-Door 07-12 Wrangler, One Piece Design | 12950.01 |
| Floor Liner, Rear, 2-Door 07-12 Wrangler, Pair | 12950.02 |
| Cargo Liner, 2 and 4-Door 07-10 Wrangler | 12975.01 |
| Cargo Liner, 2 and 4-Door 11-12 Wrangler, NEW | 12975.03 |
| Floor Liner Kit, Front and Rear, 07-12 Wrangler 4-Door | 12987.01 |
| Floor Liner Kit, Front and Rear, 07-12 Wrangler 2-Door | 12987.02 |



2nd Row, Jeep® 07-12 Wrangler 4-Door



Self-sealing floor hook attachment feature helps to prevent dirt and moisture from getting through. The mat reseals itself around the hook!

The deeply molded Chevron shape tread pattern channels dirt, mud and snow away from the driver to keep shoes and pant legs clean. "Deep Tread" technology!

The high perimeter wall offers a large footprint and maximum interior protection and containment.



Jeep® 07-12 Wrangler 2-Door & 4-Door

Easy to clean design; simply hose off and go!





RUGGED RIDGE® SUN VISOR COVERS FOR 2007-12 JEEP® WRANGLER

Instantly turn those plastic factory sun visors on your 2007-2012 Wrangler into usable storage space while getting a clean new look with Custom Rugged Ridge® Visor Covers. Each pair of visor covers quickly and easily attach to your factory sun visors without drilling or vehicle modification. Constructed of durable interior matching textured black vinyl, these covers will provide the storage and features you want while looking great. The driver's side cover features a see through bottom window to expose the factory warning labels and an inside storage pocket with custom storage options; two pen/tire gauge holders, clear window registration/insurance card holder, Mesh storage pocket for commonly used items like garage door openers and a cavernous fold down storage pocket that can hold CD's and cell phones. The passenger side cover offers the same cavernous storage pocket as the driver's side (great for road maps!) but also features a vanity mirror. Packed as drivers' and passenger set, these great covers are the perfect add on accessory for your Jeep®! Note: 2007-09 Visor Covers will not interchange with 2010-2012 Wranglers due to factory visor change.

| Rugged Ridge® Sun Visor Covers | Part # |
|--------------------------------|----------|
| 07-09 Wrangler NEW | 13305.07 |
| 10-12 Wrangler NEW | 13305.08 |

RUGGED RIDGE® OVERHEAD STORAGE CONSOLE FOR 2007-12 JEEP® WRANGLER



The Rugged Ridge® Overhead Storage Console is the storage solution you have been waiting for! It instantly turns the area underneath your top into usable storage space without any interference or modification to your vehicle. Fits all 2007-2012 Jeep® Wranglers! Works with soft tops, hardtops, the top up, or the top down. The Overhead Storage Console is a fully enclosed storage compartment that installs easily without any tools or drilling. It is constructed from durable blow molded High-Density polyethylene (HDPE), so it is safer and lighter than steel. A non-skid pad is adhered to the inside of the console to help keep your gear from sliding around, and a mesh storage net helps keep it safely stowed yet easily accessible. The console measures 41.5"x2.5"x6.5" and offers more than 450 cubic inches of storage.

| Rugged Ridge® Overhead Storage Console | Part # |
|--|----------|
| 07-12 Wrangler NEW | 13551.14 |



DASH ORGANIZER FOR 2007-10 WRANGLER

Looking for space to store that clutter? Introducing the new Rugged Ridge® Dash Organizer for 2007-2010 Jeep® Wranglers! This innovative new product incorporates existing mounting points to install a dual tray storage system right on your dash. Now you can easily store coins, pens, sunglasses, cell phones and other small items right in reach of both the passenger and driver. Installation is a snap; simply remove the original equipment screw covers on your dash, screw in the exclusive double headed mount and attach the Dash Organizer. It is that easy! Each Dash Organizer incorporates UV treated thermoplastic mounts and two trays with a painted aluminum cross tube for the ultimate in flexible design. Each tray can be mounted across the aluminum tube with thumb screw attachments. Rubber feet attached to the trays prevent rattling and provide a secure fit. The small tray has a special built in slot for MP3 players or cell phones with a belt clip (not included). Each tray has a special "recessed guide" that can be easily drilled out to create an out-of-the-way power cord locator. This exciting design has a low profile and does not interfere with driver visibility or air bag deployment.



| Rugged Ridge® Organizers | Part # |
|---|----------|
| Dash Organizer, 07-10 Wrangler <small>*will not fit 2011-2012 models</small> | 13551.10 |

Each Dash Organizer also includes a split bracket CB mounting kit and separate CB microphone holder for use with most smaller CB units. Holes in the bottom of the large tray have been pre-drilled for easy installation of these brackets and include a recessed area for optional out-of-the-way power cord use.

REAR STORAGE BIN FOR 2007-10 WRANGLER

Protect your carpet from moisture, dirt, and grease with the exclusive Rugged Ridge® storage bin for 07-10 Wrangler. This custom fit storage bin fits perfectly in the rear cargo area storage compartment providing protection and an easy to use removable tote. Molded from rigid and durable ABS plastic for a perfect contoured fit and long life. The unique chevron pattern matches the look of the All Terrain Floor and Cargo Liners. Each bin features integrated handles for ease of removal and cleaning.

| Rugged Ridge® Storage Bin | Part # |
|---|----------|
| Rugged Ridge® Storage Bin, 07-10 Wrangler | 13122.01 |



TRAIL BAGS

Rugged Ridge® has the answer for your onboard storage needs. These soft-side storage bags feature heavy canvas construction and oversized zippers. Great for carrying recovery gear, spare parts, camping gear, clothes, or any other necessity for a wheeling trip. Rugged nylon straps keep the bags in place during even the most insane wheeling. Make the most out of your roll cage with a full complement of Rugged Ridge® storage bags. These bags are easy to install and take off and work with both hard tops and soft tops.



| Trail Bags | Part # |
|--|----------|
| Seat Back Trail Bag, Detachable, 07-12 Wrangler, Each | 13551.25 |
| Seat Back Trail Bag, 07-12 Wrangler, Each | 13551.26 |
| Sport Bar Trail Bag, Canvas Storage Bag, 07-12 2-Door Wrangler, Each | 11250.06 |
| Sport Bar Trail Tube Bag, 07-12 Wrangler, Each | 11250.05 |

JK REAR SEAT ORGANIZER

The perfect organization solution for your Jeep®! The new Rugged Ridge® Back Seat Organizer features two separate storage areas to organize wayward trash, toys, drinks, iPods and other clutter. Each organizer is designed to instantly fit into the rear cup holders of your 2007-10 Jeep® Wrangler and includes a removable double walled lid. The large storage area will hold up to three 12oz. soda cans or two 16.9oz. water bottles with ice. The top lid can be easily removed creating a handy writing surface or small tray. The front tray can keep cell phones, iPods or other small items from rolling around the back seat. Easily removable to clean and empty, this truly is a must for your Jeep®!

| JK Rear Seat Organizer Description | Part # |
|---|----------|
| Rear Seat Organizer, Jeep® Wrangler [JK] 07-10 NEW | 13551.15 |

*will not fit 2011-2012



SUNGLASS HOLDER/ROLL BAR STORAGE

Another perfect organization solution for your Jeep®! Allows you to stow your sunglasses, wallet, GPS, or other small accessories within arms reach. A perfect size zipper storage pouch allows for added storage right where you need it. Attaches easily to your sport bar using hook and loop fasteners-no drilling required



| Sunglass Holder | Part # |
|--------------------------------|----------|
| All Jeep® Wranglers NEW | 12101.52 |

NEW!

CUSTOM FIT NEOPRENE SEAT COVERS



13214.53 Front Seat Covers
Neoprene, 07-10 Wrangler

Protect your Jeep's® interior with these Custom Fit Neoprene Seat Covers from Rugged Ridge®. These covers are constructed of durable 100% neoprene with no filler fabrics creating the best fitting, longest lasting neoprene seat cover available. Neoprene [wetsuit material] is a great fabric to protect your seats from dirt, water and whatever mother nature can throw at you! Each cover is custom tailored for your Jeep's® original equipment seat style making your seats look like they have been recently reupholstered.

Installation is easy with special designed elastic cords, nylon straps and hooks that attach to your seat and to the seat cover mounting points. All seams have been double reinforced for strength and a special backing fabric is used on the seams for added protection against rips and tears. Available in black on black, gray on black, red on black and tan on black to complement virtually any Jeep® interior.

| Custom Neoprene Seat Covers | Black/ Black | Black/ Gray | Black/ Red | Black/ Tan |
|---|-----------------|----------------|---------------|---------------|
| Front, 07-10 Wrangler with or without Side Airbags, Pair | 13214.01 | 13214.09 | 13214.53 | - |
| Front, 2011-12 Wrangler with or without Side Airbags, Pair NEW | 13215.01 | 13215.09 | 13215.53 | 13215.04 |
| Rear, 07-12 Wrangler 4-Door, Pair NEW | 13264.01 | 13264.09 | 13264.53 | 13264.04 |
| Rear, 07-12 Wrangler 2-Door, Pair NEW | 13265.01 | 13265.09 | 13265.53 | 13265.04 |

13264.53



13264.09



13264.09

Rear Seat Covers, Neoprene, 07-12 Wrangler,
Includes Separate Headrest Covers



Black

Gray

Red

Tan



13214.01

Front Seat Covers,
Neoprene, 07-10 Wrangler, Includes
Separate Headrest Covers

All images are subject to be representative. More detailed information is available online.

NEOPRENE SEAT PROTECTORS FOR 2007-12 WRANGLER

Protect your seats from the elements, wet bathing suits and spills while providing a great look. Each set of seat protectors includes back pockets for rear storage as well as a removable cup holder. Cushioned center portion gives the Seat Protector a great look and provides you extra comfort on those long road trips. New solid color design further enhances the look of your Jeep®.



13235.20 Seat Protector, Black, 07-12 Wrangler



07-12 Wrangler Neoprene Seat Protector

With Factory Side Air bags, Pair

Black

13235.30

Gray

13235.32

Tan

13235.21

ARM REST PAD FOR 2007-10 WRANGLER

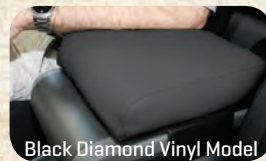

Rugged Ridge®'s Patented Arm Rest Pad bolts directly into existing JK mounting screws-no need to remove the OE lid. Steel brackets ensure durability. Uses either Neoprene or tough vinyl coated polyester fabric with a dense foam center for comfort, performance and a great look in the vehicle. Allows for full opening and closing of the console lid. No drilling required.

Arm Rest Pad For 07-10 Wrangler

Part #

| | |
|---------------------------|----------|
| Black Diamond Vinyl, Each | 13107.35 |
| Black/Gray Neoprene, Each | 13107.09 |
| Black Neoprene, Each | 13107.01 |

CENTER CONSOLE ARMREST PAD

This easy to use arm rest pad/cover from Rugged Ridge® provides protection and comfort all in one! Constructed of heavy duty neoprene (wet suit material) with an added layer of padding for the arm rest, this slip on cover provides an extra soft place to put your arm while driving. Since it covers the entire top of the arm rest, this cover also provides added arm rest protection from pet claws, dirt and sticky fingers. Installation is easy with an elastic band; no drilling or tools required. Black Neoprene compliments your vehicle's interior and will match custom fit Neoprene seat covers. Limited three year warranty.



Center Console Armrest Pad

Part #

11-12 Wrangler, Black, Neoprene **NEW**

13108.01

SUV/JEEP® STORAGE BAG

Custom designed to provide removable storage for Jeep® vehicles. Special size fits behind rear seat to organize and store your cargo. Constructed of durable vinyl with a zipper top and removable cargo dividers - easy to use shoulder strap included.



Off-Jeep®/SUV Storage Bag

Part #

Universal all Jeep®

13551.01

OFF-ROAD ORGANIZER

Custom design for use in Jeep® glove boxes. Special pockets allow you to effectively organize owners manuals, maps, tire gauges, vehicle registration and more. Constructed of durable nylon in a tri-fold configuration.



Off-Road Organizer

Part #

Universal

13305.06



BILLET INTERIOR TRIM & UNDER HOOD GARNISH FOR 2007-2011 WRANGLER

Enhance the appearance of your Jeep® with these premium CNC machined billet aluminum accessories from Rugged Ridge®. Available in a lightly brushed or black anodized finish. These high quality accessories replace your factory components with no drilling or modification. The easy installation allows you to upgrade your interior in minutes with simple hand tools!

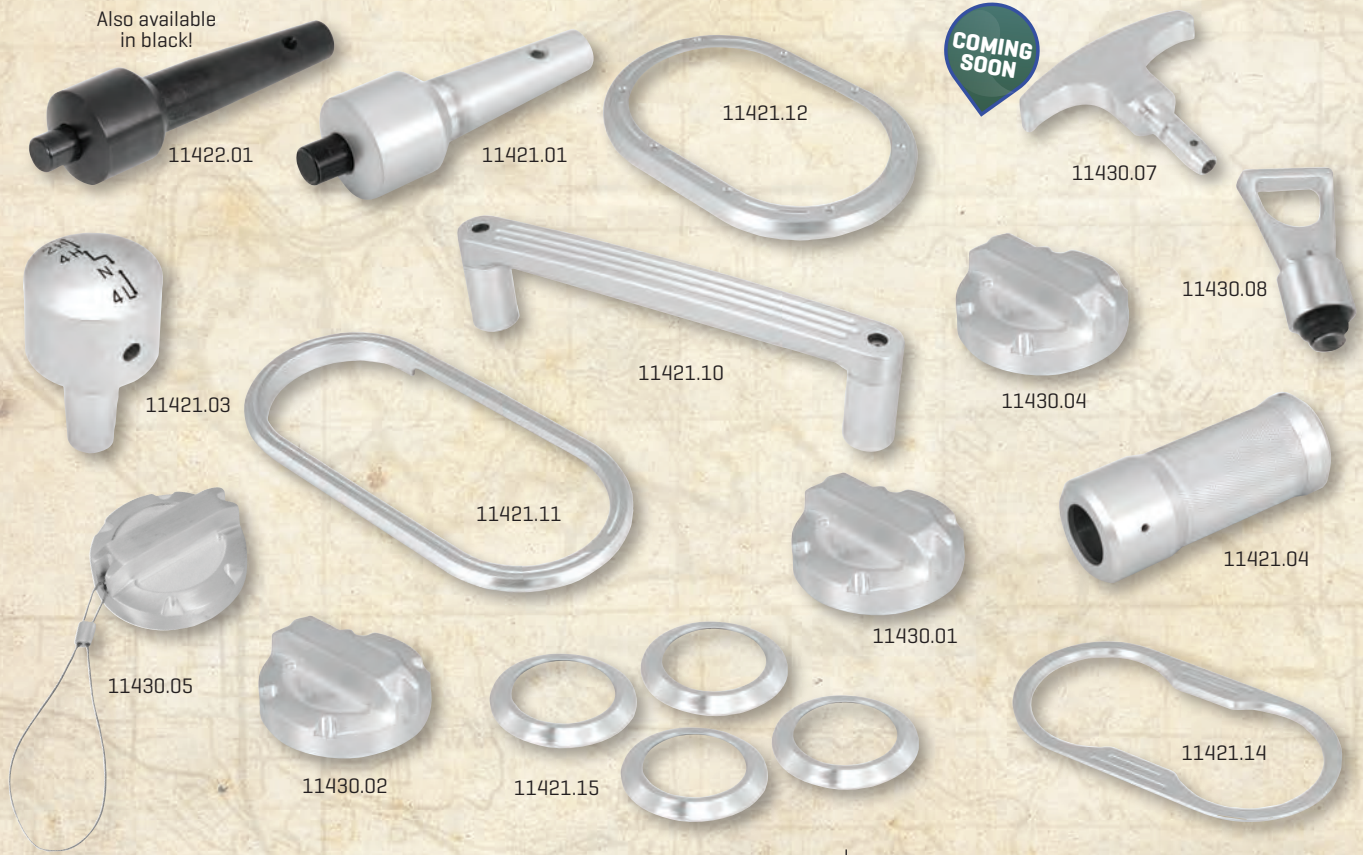

Also available in black!

COMING SOON



11421.02

Billet Aluminum Components COMING SOON!

| | Brushed Aluminum | Black |
|---|------------------|----------|
| Wrangler 07-10, Automatic Transmission Shifter Knob, Billet Aluminum | 11421.01 | 11422.01 |
| Wrangler 07-10, Manual Transmission Shifter Knob, Billet Aluminum | 11421.02 | 11422.02 |
| Wrangler 07-10, Transfer Case Shifter Knob, Billet Aluminum | 11421.03 | 11422.03 |
| Wrangler 07-10, Emergency Brake Handle Cover, Billet Aluminum | 11421.04 | 11422.04 |
| Wrangler 07-10, Passenger Grab Bar Handle, Billet Aluminum | 11421.10 | 11422.10 |
| Wrangler 07-10, Automatic Transmission Shifter Bezel, Billet Aluminum | 11421.11 | 11422.11 |
| Wrangler 07-10, Manual Transmission Shifter Bezel, Billet Aluminum | 11421.12 | 11422.12 |
| Wrangler 07-10, Cup Holder Bezel, Front, Billet Aluminum | 11421.14 | 11422.14 |
| Wrangler 07-10, AC Vent Bezels, Set of Four, Billet Aluminum | 11421.15 | 11422.15 |
| Wrangler 07-11, Power Steering Cap, Billet Aluminum | 11430.01 | 11431.01 |
| Wrangler 07-11, Brake Master Cylinder, Billet Aluminum | 11430.02 | 11431.02 |
| Wrangler 07-11, Oil Cap, Billet Aluminum | 11430.04 | 11431.04 |
| Wrangler 07-11, Washer Fluid Cap, Billet Aluminum | 11430.05 | 11431.05 |
| Wrangler 07-11, Oil Dipstick Handle, Billet Aluminum | 11430.07 | 11431.07 |
| Wrangler 07-11, Automatic Transmission Dipstick Handle, Billet Aluminum | 11430.08 | 11431.08 |

BILLET ALUMINUM CLIMATE CONTROL KNOBS

Billet aluminum Wrangler Climate Control Knobs. These stylish knobs are easily installed by pulling off the factory knobs and pushing these back in their place. Choose red or blue colored inserts in the face of the knobs to illuminate at night and show their position.



Billet Aluminum Climate Control Knobs

| | Part # |
|---|----------|
| 07-10 Wrangler/Unlimited, Blue Indicator Lights, Set of 3 | 11420.05 |
| 07-10 Wrangler/Unlimited, Red Indicator Lights, Set of 3 | 11420.06 |

All images are subject to be representative. More detailed information is available online.

Wrangler 07-12

BRUSHED SILVER/CHROME INTERIOR TRIM FOR 2007-10 WRANGLER



Make your 07-10 Wrangler unique with Rugged Ridge® interior accents. These injection-molded plastic accents are molded directly from the factory interior pieces for an exact fit. Installation is a snap thanks to the pre-installed high-strength adhesive tape. Available in brushed silver (matches factory Rubicon interior trim pieces) or chrome finish.



11151.01 Brushed Silver Shifter Trim



11151.10 Brushed Silver AC Vent Trim



11156.10 Chrome AC Vent Trim

2-Door Kits include: accents for Shifter, AC Vent Covers, Tweeter Speakers, Steering Wheel, Front Clip Holder, Dash Panel, Grab Handle, Front Door Handles, and Front Door Pulls.

4-Door Kits include: all the accents in the 2-Door Kit plus Rear Door Handles & Rear Door Pulls.

*Manual window kits do not include door pulls.

| Description | Brushed Silver | Chrome |
|---|----------------|----------|
| Interior Trim Accent Kit, 07-10 2-DOOR - Manual Trans - Manual Windows NEW | 11151.92 | 11156.92 |
| Interior Trim Accent Kit, 07-10 2-DOOR - Auto Trans - Manual Windows NEW | 11151.93 | 11156.93 |
| Interior Trim Accent Kit, 07-10 4-DOOR - Manual Trans - Manual Windows NEW | 11151.97 | 11156.97 |
| Interior Trim Accent Kit, 07-10 4-DOOR - Auto Trans - Manual Windows NEW | 11151.98 | 11156.98 |
| Interior Trim Accent Kit, 07-10 2-DOOR - Manual Trans - Auto Windows NEW | 11151.90 | 11156.90 |
| Interior Trim Accent Kit, 07-10 2-DOOR - Auto Trans - Auto Windows NEW | 11151.91 | 11156.91 |
| Interior Trim Accent Kit, 07-10 4-DOOR - Manual Trans -Auto Windows NEW | 11151.95 | 11156.95 |
| Interior Trim Accent Kit, 07-10 4-DOOR - Auto Trans - Auto Windows NEW | 11151.96 | 11156.96 |



Trim can be painted to match your custom interior!

| Components | Brushed Silver | Chrome |
|--|----------------|----------|
| A. Shifter Trim Manual Transmission | 11151.01 | 11156.01 |
| B. Shifter Trim Automatic Transmission | 11151.02 | 11156.02 |
| C. AC Vent Cover [Pair] *Need 2 pairs | 11151.10 | 11156.10 |
| D. Tweeter Speaker Grille [Pair] | 11151.11 | 11156.11 |
| E. Steering Wheel Spoke Accents [Set] | 11151.12 | 11156.12 |
| F. Front Cup Holder Trim | 11151.13 | 11156.13 |
| G. Dash Panel Accent Trim [Pair] | 11151.14 | 11156.14 |
| H. Grab Bar Handle | 11151.15 | 11156.15 |
| I. Interior Door Handle Covers [Pair] *Need 2 pairs for 4-Door | 11151.20 | 11156.20 |
| J. Front Door Pull Handle [Pair] * | 11151.16 | 11156.16 |
| K. Rear Door Pull Handle [Pair]. [For 4-Door Only] * | 11151.17 | 11156.17 |
| L. Rear Cup Holder Accent, 2Dr/4Dr, NEW | 11151.18 | 11156.18 |

* For models equipped with power windows only. Will not work with manual windows.

All images are subject to be representative. More detailed information is available online.

Doors

HALF DOORS

NEW!



*Paintable impact resistant thermoplastic outer door skins!

Features and Benefits

- Get the open air fun and factory look for a lot less money. Finally the half door solution Jeep® owners have been waiting for!
- Impact resistant thermoplastic black ABS material with enhanced UV protection.
- Matte finish is easily paintable for custom match factory look.
- Specially reinforced internal steel frame provides strength and is powder coated to resist corrosion.
- The interior of our new half doors were not forgotten about in development. The textured inner ABS panels provide a finished look and feature a grab handle and molded storage pocket.
- Light weight half doors provide added convenience and utility with improved visibility on the trails.
- Each door has a weather tight seal to keep out moisture and reduce wind noise.
- OE Style Hinges provide a factory look and are designed to last.
- Durable and lockable paddle handle.
- Matching soft upper doors available for all season protection from the weather.
- Designed to work with your original mirror or for added convenience permanently install a pair of Rugged Ridge® replacement mirrors.
- Adjustable nylon door strap allows you to control and adjust how far the door opens.
- Attaches to factory hinge and door latch locations—easy no-drill install.
- Front pairs fit 2-door and 4-door Fronts, Rear pairs fit 4-door Rears.



Rugged Ridge® Half Doors

| | Part # |
|---|----------|
| Half Door, Front, Jeep® Wrangler [JK] 07-12 [Pair] NEW | 11509.01 |
| Half Door, Rear, Jeep® Wrangler [JK] 07-12 [Pair] NEW | 11509.02 |
| Upper Soft Door, Front, Jeep® Wrangler [JK] 07-12 [Pair] NEW | 13711.15 |
| Upper Soft Door, Rear, Jeep® Wrangler [JK] 07-12 [Pair] NEW | 13712.15 |

TUBE DOORS

Like the "doors off" feel but also want the added convenience and utility of having doors on the trail? Rugged Ridge® Tube Doors are constructed from durable 1.5" mandrel bent steel tube that is E-Coated primered and then textured powder coated for a long lasting finish. Tube doors help increase visibility when climbing obstacles and trail riding. The Tube Doors interchange easily with the factory steel doors and require no body modification for installation. They are light weight and small enough to be stored easily in back of the vehicle when not in use.

Features and Benefits

- Thicker than most other tube doors with durable 1.5" diameter steel tubing construction providing added strength and great looks.
- E-coat and textured powder coat for corrosion resistance.
- Tube doors provide added convenience and utility for improved visibility on the trails.
- Design to work with your original mirror or for added convenience permanently install a pair of Rugged Ridge® replacement mirrors.
- Adjustable nylon door strap allows you to control and adjust how far the door opens.
- Half doors are easy to install and remove and are small enough to be stored in the vehicle.
- Optional cargo storage kit available that can be configured to use in a variety of ways.
- Durable and lockable paddle handle.
- Sold as a front pair and also a rear pair is available for 4 door JK.
- Attaches to factory hinge and door latch locations, easy no-drill install.



Rugged Ridge® Tube Doors

| | Part # |
|---|----------|
| Tube Doors Front, JK 07-12, pair NEW | 11509.10 |
| Tube Doors Rear, JK 4-Door 07-12, pair NEW | 11509.11 |



TUBE DOOR CARGO COVERS

Add a fully adjustable Molle / Pals storage solution to your tube doors! The Rugged Ridge® Tube Door Cargo Covers are made from 600 denier polyester fabric with a durable vinyl backing. Our storage solution features an assortment of five different storage pouches with internal storage compartments. The great Molle / Pals mounting system allows you to arrange the pouches however you wish, or grab them and go! They mount on any backpack that features the Molle / Pals system! The tube doors and Cargo Covers take up less space than the OE steel doors, so unlike other systems you still have plenty of room for your knees! The Cargo Covers are designed with adjustable mounting straps that allow you to configure the cargo system with both Rugged Ridge® and most other aftermarket tube doors.

Rugged Ridge® Tube Doors Cargo Covers

| | Part # |
|---|----------|
| Tube Door Cargo Covers, JK 07-12 NEW | 13247.01 |

NEW!



DOOR LATCH SET

Door latches are included with half doors and tube doors, but are available separately for custom applications.

Door Latch Set

| | Part # |
|--|----------|
| Half & Tube Doors, 07-12 Wrangler, Pair NEW | 11812.80 |

NEW!



COMING SOON



These billet mechanical door stops replace the troublesome nylon door check straps that are provided from the factory. The billet door stops incorporate a sliding arm with two stop positions that keep the door from swinging closed when passenger exists the vehicle. The dual nylon heim joints allow the door to open and close smoothly, while the billet stop keeps the doors from swing free and damaging the hood and fender. They also feature an easy quick release so you can remove the doors for off road use. Easy no drill installation!

BILLET DOOR STOPS

| Billet Door Stops | Part # |
|---|----------|
| Wrangler 07-12, Each COMING SOON | 11238.31 |
| Wrangler 07-12, Pair COMING SOON | 11238.30 |



QUICK RELEASE MIRROR RELOCATION

The mirrors mount to a bolt on bracket and are secured with a locking knob that allows for easy installation and removal. The long adjustable arms give you great visibility with your doors off or on! Available in durable black powder coat or stainless steel finish.



| 07-12 Wrangler Relocation Mirrors | Part # |
|--|----------|
| Quick Release Mirror Relocation Kit, Pair, Black NEW | 11025.10 |
| Mirror Relocation Kit, Black, Includes Mirror, LH or RH Does Both Sides NEW | 11025.11 |
| Quick Release Mirror Relocation Kit, Pair, Stainless Steel, Does Both Sides NEW | 11026.10 |
| Mirror Relocation Kit, Stainless Steel, LH or RH Does One Side NEW | 11026.11 |

FACTORY STYLE JK MIRRORS FOR WRANGLER

| Factory Style Replacement Mirrors for JK | Black | Black w/LED | Chrome | Chrome w/Led |
|---|----------|-------------|----------|--------------|
| 07-12 Wrangler, Passenger Side NEW | 11002.12 | 11002.14 | 11010.12 | 11010.14 |
| 07-12 Wrangler, Driver Side NEW | 11002.13 | 11002.15 | 11010.13 | 11010.15 |
| 07-12 Wrangler, Kit, Pair NEW | 11002.21 | 11002.22 | 11010.11 | 11010.16 |



* Fits 2011-2012 Wrangler models equipped with manual mirrors. Will not work with power mirrors.



NEW!

REAR VIEW MIRRORS



11020.02 Rear View Mirror, Black, 07-12 Jeep® Wrangler

| Rear View | Part # |
|-----------------------|----------|
| 07-12 Wrangler, Each* | 11020.02 |
| Mounting Glue, Each | 11021.01 |

* Includes mounting glue button.

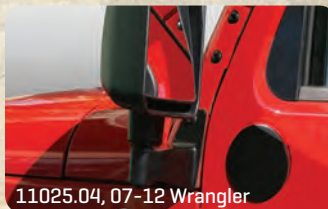

MIRROR RELOCATION BRACKETS & DOOR FILLER PLATES

Custom designed brackets bolt into existing holes on the windshield relocating your mirrors off the door. The perfect add-on accessory for those off-road adventures where you do not want your doors. Each bracket kit for the 2007-12 Wrangler comes with a special paintable filler plate to cover up the hole created when you remove your mirrors. Sold in pairs.

When you want to remove your doors from your Jeep® and permanently mount side mirrors to your "A" pillar, you need a filler plate to fill the left over hole on your door. Each steel filler plate attaches to the door using enclosed bolts and can be easily painted to match your door. These filler plates can also be used on Rugged Ridge® half doors and are a perfect addition when using the new Rugged Ridge® Quick release mirrors #11025.10 which place the mirrors directly on the A pillar.

| Mirror Relocation Brackets | Stainless | Black |
|-------------------------------------|-----------|----------|
| 07-12 Wrangler w/Filler Plate, Pair | 11026.04 | 11025.04 |
| 07-12 Wrangler, Pair NEW | 11026.10 | 11025.10 |
| 07-12 Wrangler, Pair NEW | 11026.11 | 11025.11 |

Fits 2011-2012 Wrangler models equipped with manual mirrors. Will not work with power mirrors.

| Mirror Relocation Filler Plates | Part # |
|--|----------|
| 07-12 Wrangler, Black, Pair NEW | 11025.05 |

All images are subject to be representative. More detailed information is available online.

NEOPRENE GRAB HANDLE AND DOOR HANDLE COVERS

Protect and upgrade the look of your Wrangler with these easy to install door and grab handle wraps. Each wrap is constructed of durable neoprene and covers each door handle as well as the passenger side grab handle. Four door models include 5 pieces [Grab Handle and four door handles] while two door models have 3 pieces [Grab Handle and two door handles].



| Grab & Door Handle Kit | Black | Red |
|----------------------------------|----------|----------|
| 07-10 Wrangler 4-Door, 5 pc. Kit | 13305.54 | 13305.55 |
| 07-10 Wrangler 2-Door, 3 pc. Kit | 13305.56 | 13305.57 |

FIRE EXTINGUISHER HOLDERS

Special designed holder incorporates thick nylon web straps that secures your Fire extinguisher to the roll bar. Straps are fully adjustable and secure with hook and loop fasteners. Holds one 3lb. fire extinguisher [not included].

13305.21



| Roll Bar Fire Extinguisher Holder | Black | Red |
|-----------------------------------|----------|----------|
| For all Jeep® 3" Roll Bars, Each | 13305.21 | 13305.20 |

ROLL BAR DRINK HOLDER

Quickly places a convenient drink holder anywhere along your Jeeps® Sport Bars. Padded nylon drink holders attach with quick release "hook & loop" straps and hold a variety of cups and water bottle sizes. Foam insulation keeps your favorite beverage cool in the hot summer sun. Packed in pairs for both front and back seat use.



| Roll Bar Drink Cup Holder | Part # |
|-------------------------------|----------|
| For all Jeep® Roll Bars, Pair | 12101.51 |

LED COURTESY LIGHTS

The natural design of a Jeep® interior does not provide adequate interior lighting for map reading or looking for items inside your Jeep®. Now you have two outstanding options for interior lighting with the new Rugged Ridge® LED Courtesy Lights. Each lighting option features an extra bright, energy efficient LED light powered by 3 AAA batteries [not included] so there is no wiring required. The Roll Bar mount design attaches to any 2-3" roll bar using heavy duty straps and hook and loop fasteners. The NEW header mount courtesy light attaches with screws to the interior location of your choice. However, we suggest it being placed on the front header portion of the 2007-2012 Wrangler putting light in the center front of your Jeep® interior within easy reach of both driver and passenger. In this application, the screws mount directly to the plastic header making installation easy, secure and providing maximum lighting for the interior of your Jeep®.



| LED Courtesy Lights | Part # |
|---|----------|
| Interior Courtesy Light, LED, Front Header Screw mount, Jeep® Wrangler [JK] 2007-2012 NEW | 12430.01 |
| Interior Courtesy Light, LED, Roll Bar Mounted, Universal Application [With 2-3 Inch Roll Bar] NEW | 11250.08 |

TAILGATE STOP

This billet aluminum door stop incorporates a sliding arm that locks into place keeping your tailgate door open even on the most severe slopes. Load your Jeep® with ease! Some drilling required to install on the inside of your tailgate.



| Tailgate Stop | Part # |
|----------------------|----------|
| 07-12 Wrangler, Each | 11238.11 |

ROLL BAR DOME LIGHT



Hard wired light illuminates the cab area of your Jeep®. Attaches to the roll bar with easy to use straps. No drilling required.

| Roll Bar Dome Light | Part # |
|--------------------------|----------|
| For all Jeeps® Roll Bars | 11250.01 |

BACK SEAT HEATER

This 300 watt, 12 volt heater will warm your vehicle quickly keeping you and your passengers comfortable. Designed to fit on the rear wheel well of any Jeep®, this easy to use heater wires easily to your existing electrical system. Some drilling may be required.



| Back Seat Heater | Part # |
|--------------------|----------|
| All Jeeps® & SUV's | 13150.01 |

FLASHLIGHT HOLDERS

Keep your flashlight where you know it will always be. Choose either the sport bar holder or the steel mounting brackets, which screw mount to any flat surface. Flashlight not included, but you knew that.



11238.06



11205.20 Sportbar Flashlight Holder

| Flashlight Holders | Part # |
|--|----------|
| Sport Bar Flashlight Holder, 07-12 Wrangler, Each | 11205.20 |
| Mounting Brackets for 1.5" Diameter Flashlights, Universal Application, drilling required, Pair. | 11238.06 |

ROLL BAR COAT HANGER KIT

Makes hanging your coat or laundry easy. Attaches to the roll bar with two nylon straps. Sold in pairs.

11250.03



| Roll Bar Coat Hanger | Part # |
|----------------------------|----------|
| For all Jeeps® w/Roll Bars | 11250.03 |



ULTIMATE/DELUXE/NEOPRENE AND SPORT GRAB HANDLES

Put easy to use Grab Handles wherever you need them. Constructed of tough nylon webbing with either a molded sure-grip handle (Ultimate), soft foam handle (Deluxe) or plain Nylon webbing (Sport). The Ultimate Grab Handles are available in two hot colors to accent the Jeeps® interior-Red & Black. Deluxe and Sport models fit all Jeep® roll bars and 3" roll cages with padding. Ultimate Grab Handles will fit 2" or 3" padded or un-padded roll bars. All designs are packed in pairs.



13305.02 Deluxe Grab Handle



13505.03 Ultimate Grab Handle



13305.01 Sport Grab Handle

Ultimate/Deluxe and Sport Handles, 07-10 Wrangler

| | |
|--|----------|
| Ultimate Grab Handles, Pair - Red | 13505.03 |
| Ultimate Grab Handles, Pair - Black | 13505.04 |
| Deluxe Grab Handles, Pair | 13305.02 |
| Sport Grab Handles, Pair | 13305.01 |
| Neoprene Wrapped Deluxe Grab Handles, Passenger/Driver Side Roll Bar, Pair - Black | 13305.30 |
| Neoprene Wrapped Deluxe Grab Handles, Passenger/Driver Side Roll Bar, Pair - Red | 13305.31 |

Part #

| |
|----------|
| 13505.03 |
| 13505.04 |
| 13305.02 |
| 13305.01 |
| 13305.30 |
| 13305.31 |



13505.04 Ultimate Grab Handle



13305.30 Neoprene Wrapped Deluxe Grab Handle

Wrangler 07-12

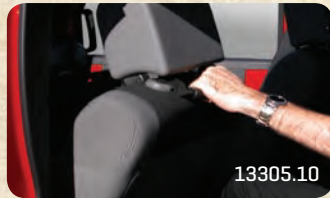

13305.10



13305.15

Dual Application



13305.14



13305.15

GRAB HANDLES FOR 2007-12 JEEP® WRANGLER

Three styles to choose from - Rear Side Grab Handles for easy entry and exit attach directly into factory mounting holes with your original hardware. They also double as Front Seat Grab Handles by easily attaching to the windshield pillar with supplied hardware. Rear Seat Grab Handles attach to the head rest of your JK front seats. Finally, we have developed a Neoprene Wrapped design for over driver and passenger that completes the entire JK package!

Grab Handles

| | Red | Black |
|---|----------|----------|
| 07-12 Wrangler, Seat Mount Grab Handles, Pair | 13305.11 | 13305.10 |
| 07-12 Wrangler Rear Side/Windshield Pillar Grab Handles, Pair | 13305.15 | 13305.14 |
| 07-12 Wrangler, Black, 5 Piece Kit NEW* | | 12496.14 |

*Includes: 13305.04, 13305.14 & 13305.12



13305.13 Center Roll Bar Dual Grab Handle

REAR DUAL GRAB STRAP FOR JEEP®

Gives back seat passengers a place to hold on while on the trail. Constructed of durable nylon webbing with soft molded foam handles for ease of use and comfort. Easily attaches with hook and loop around the center roll bar or to factory mounts. No drilling required. Special side "pockets" create a handy spot for hanging clothes.

Rear Dual Grab Strap

| | Red | Black |
|----------------------|----------|----------|
| 07-12 Wrangler, Each | 13305.13 | 13305.12 |



11119.05 Entry Guards, 4-Door 07-12 Wrangler, Stainless



11216.10

BLACK & STAINLESS ENTRY GUARDS

Protect your door threshold with these stylish entry guards. Available in three different finishes, black, polished stainless and aluminum to enhance the look of your Jeep® while providing the ultimate in protection. 2007-12 Wrangler entry guards available for 2 & 4-Door models [2-Door kits will fit front 4-Door applications]. 2007-12 Wrangler models attach without screws using durable double sided automotive grade adhesive.

Entry Guards

| | Stainless | Black |
|---|-----------|----------|
| 07-12 Wrangler Front Door Openings Only (2 & 4-Door) Pair | 11119.04 | 11216.10 |
| 07-12 Wrangler 4-Door Rear, Pair | 11119.05 | 11216.11 |

All images are subject to be representative. More detailed information is available online.

BUG DEFLECTOR SHIELD

Protect your windshield and hood from flying debris and bugs with this durable Bug Deflector from Rugged Ridge®. Constructed of durable shatter resistant smoked acrylic, this bug shield is designed to last the test of time. Installation is easy using double sided automotive adhesive tape and under hood screw attachments (some drilling required).



NEW!

| Rugged Ridge® Bug Deflector Shield | Part # |
|------------------------------------|----------|
| 07-12 Wrangler NEW | 11350.02 |

WINDOW RAIN DEFLECTOR

NEW!

| Rugged Ridge® Window Rain Deflector | Part # |
|---|----------|
| Front, Smoked Acrylic, Wrangler 2-Door [JK] 07-12 NEW | 11351.11 |
| Front & Rear, Smoked Acrylic, Wrangler 4-Door [JK] 07-12 NEW | 11351.12 |



GRILLE/BILLET GRILLE INSERTS

Durable UV treated inserts enhance the front of your Jeep®. Available in your choice of Black or Chrome with or without aluminum billet inserts, these inserts add great styling and a unique appearance. All Rugged Ridge® inserts easily install without drilling or tools. Just click them in and go! Add on the black or stainless Euro-Guards or black headlight bezels for the sharpest look on the market!



11306.30 Black Grille Inserts



11401.30 Black w/Aluminum Billet Grille Inserts



COMING SOON

11401.31 Billet Grille Insert Screen

| Grille Inserts | Black |
|---|----------|
| Black, 2007-12 Wrangler , Set of 7 | 11306.30 |
| Black w/ Aluminum Billet, 2007-12 Wrangler , Set of 7 | 11401.30 |
| Billet Grille Insert Screen, Gross Black, 2007-2011 Wrangler NEW | 11401.31 |



PARKING LIGHT BEZELS



| Parking Light Bezels | Part # |
|--|----------|
| Black, 07-12 Wrangler, Pair NEW | 12419.26 |

REPLACEMENT HEADLIGHT BEZELS

Complete the look of your front end with these easy to install head light and turn signal lamp bezels from Rugged Ridge®. Each UV treated bezel easily attaches to factory mounting points creating a clean look. Matched up with the Rugged Ridge® Grille Inserts, you now have that HOT look.



NEW!

12419.25

| Headlight Bezels | Black |
|---------------------------------|----------|
| 07-12 Wrangler, Pair NEW | 12419.25 |

HOOD SCOOPS

Increase the efficiency of your heater and air conditioner with these easy to install Hood Scoops. Available in UV treated chrome plastic, black UV treated plastic or durable smoked acrylic for long life and matching good looks. Ram Induction hood scoop is designed to provide maximum air flow to your passenger compartment. Installation is easy with double sided automotive grade tape. No drilling required. Mounts facing either direction.

| Hood Scoops | Smoked | Black |
|----------------|----------|----------|
| 07-12 Wrangler | 11352.10 | 11352.12 |





The Complete Look for your JK:
11230.03, 11231.11, 11231.12,
11231.13

FRONT EURO-GUARDS

Protect your headlights from debris and get that off road look with a set of Rugged Ridge® Euro-Guards. Constructed of durable powder coated steel, these front Euro-Guards are designed to last. No drilling required for installation. Each kit comes with a pair of guards to cover both sides of the vehicle. The side marker light guards are a great compliment to our front light Euro-Guards. Installation is easy and light visibility is not hampered. The parking light guards are designed to match our Headlight Euro-Guards. They feature the same great style and construction. They give a rugged look while protecting the lense. Sold in pairs.

| Black Front Euro Light Guards | | Part # |
|-------------------------------|---|----------|
| 07-12 Wrangler *, Pair | Head Light Guards | 11230.03 |
| 07-12 Wrangler *, Pair | Parking Light Guards | 11231.11 |
| 07-12 Wrangler *, Pair | Side Marker Light Guards | 11231.12 |
| 07-12 Wrangler, 4 Pc Kit | Parking Light & Side Marker Guards NEW | 11231.02 |

* fits 2 and 4-Door Wrangler



11231.02 Kit

FOG LAMP EUROGUARDS FOR 07-12 WRANGLER

Protect those expensive fog lights from impact with the Rugged Ridge® Euro Light Guards. Each Euro Light Guard is easy to install with no adhesive or drilling required. They are available in a textured black powder coat finish for long life and to match the other Rugged Ridge® Euroguards.



| EURO GUARD FOG LIGHT COVERS | Part # |
|-----------------------------|-----------|
| 07-12 Wrangler | 11231.13* |

* Except Sahara models

Create a custom look in just a few minutes. This special design fits directly over the existing gas cap opening. Available in locking and non-locking versions. They are specially treated to resist blemishes caused by gasoline or other hazardous chemicals. 2007-12 models attach with self tapping screws to plastic inner liner.

BILLET STYLE GAS COVERS



11229.02

11425.06

Protect and upgrade the look of your Jeep® with a set of Rugged Ridge® Euro Taillight Guards. Each Rear Euro Taillight Guard is easy to install with no drilling required. Rubber inserts around the mounting screws on 2007-12 models keep the metal Euro Guard off the taillight, preventing scratching and rattles.

REAR EURO-GUARDS



11226.02 Rear Euro Guard,
07-12 Wrangler

| Application | Finish | Part # |
|----------------|--|----------|
| 07-12 Wrangler | Black Aluminum, Each | 11425.05 |
| 07-12 Wrangler | Black Aluminum, Locking, Each | 11425.06 |
| 07-12 Wrangler | Black Painted Stainless, Each | 11229.02 |
| 07-12 Wrangler | Black Painted Stainless, Locking, Each | 11229.03 |

| Rear Euro Guards | Part # |
|----------------------|----------|
| 07-12 Wrangler, Pair | 11226.02 |

HINGE TREATMENTS FOR 2007-12 WRANGLER

These cast steel design Hinge Treatments are guaranteed not to rust while providing a new beefy look. Door and Hood Hinge covers feature an easy-to-install design. Replacing your existing hinges can break & crack the surrounding paint, as the hinges were painted at the factory after installation. These covers retain the stock hinges but give it a new look without harming your expensive paint. A direct bolt on - no drilling required, fits either side. Use 4 hinge treatment pairs for 4-Door models, 2 pairs for 2-Door models and 1 pair for hood.



Hinge Treatment, Black



| Hinge Treatment, Black | Part # |
|---------------------------------|-----------|
| 07-12 Wrangler, Pair | 11205.10* |
| 07-12 Wrangler 2-Door, Set of 4 | 11202.04 |
| 07-12 Wrangler 4-Door, Set of 8 | 11202.05 |

| Hood Set, Black | Part # |
|---------------------|----------|
| 07-12 Wrangler, Set | 11201.04 |

11201.04 Hood Set, 07-12 Wrangler



HOOD SETS

Make your Jeep® Wrangler unique with genuine Rugged Ridge® black exterior accessories. All accessories are powder coated in a semi gloss finish to protect your investment against the elements. Every part or kit comes with complete hardware to ensure a trouble free installation. No matter if you choose our "Locking Hood Catch", "Gas Hatch Cover" or the complete "Hood Set", Rugged Ridge® Accessories truly change and upgrade your Jeep® dramatically.

WINDSHIELD TIE DOWN KITS

These windshield tie down kits are made of steel, not plastic, for durability.



| Windshield Tie Down Kits | Part # |
|--|----------|
| 07-12 Wrangler [1 footman loop, 2 hood bumper accents, & 1 washer nozzle cover], 4-Pc. Kit | 11201.05 |

Wrangler 07-12

WINDSHIELD HINGES/BRACKETS



11209.03
Windshield
Bracket, 07-12
Wrangler

| Windshield Hinge Bracket | Part # |
|---|----------|
| 07-12 Wrangler, Windshield Hinge Brackets, Pair | 11209.03 |

WINDSHIELD LIGHT BRACKETS

Easily and quickly mounts to your factory windshield hinge creating two great spots for off-road lighting. Foam backing protects your vehicle's finish. No drilling required for installation. Sold in pairs with all mounting hardware.



11027.03 Windshield
Brackets, 07-12 Wrangler

| Stainless Windshield Light Brackets (Pair) | Part # |
|--|----------|
| 07-12 Wrangler | 11027.03 |

HOOD VENT COVERS



11206.05 Hood Vent Cover,
07-12 Wrangler

| Hood Vent Cover | Part # |
|----------------------|----------|
| 07-12 Wrangler, Each | 11206.05 |

CAST BLACK STEEL DOOR HINGES

You have black bumpers, a black top, black mirrors, black door handles and black euro-guards, why not complete the look with a set of black cast steel replacement door hinges from Rugged Ridge®? These aren't the stick on covers that our competitors offer. The heavy duty cast construction and powder coated finish ensure these hinges are built to last. The hinges are offered in sets for both the doors and hood. Includes matching black allen head bolts to complete the installation. They are direct bolt on replacement hinges for an out of the box solution, but without out all the fuss and mess of painting your factory hinges.

11202.23



NEW!



11202.22

| Door Hinges | Part # |
|--|----------|
| Cast Steel Hinges, RH, Pair NEW | 11202.22 |
| Cast Steel Hinges, LH, Pair NEW | 11202.23 |

MIRROR RELOCATION BRACKETS

Custom designed brackets bolt into existing holes on the windshield, relocating your mirrors off the door. The perfect add-on accessory for those off-road adventures where you do not want your doors. The 2007-12 Wrangler bracket kit comes with a Black filler plate to cover up the holes created when you remove your mirrors.



| Black Mirror Relocation Brackets (Pair) | Part # |
|---|----------|
| 07-12 Wrangler w/Filler Plate | 11025.04 |

*Fits 2011-2012 Wrangler models equipped with manual mirrors. Will not work with power mirrors.

FULL FRAME LIGHT BAR

This three-piece light bar simplifies your installation dramatically because you won't run the risk of scratching up your windshield frame trying to mount a heavy one-piece bar with five lights onto your windshield hinges. With this bar you can install one piece at a time. The bar is powder coated in black and packaged in a easy to ship box for your convenience.



| Full Fame Light Bar | Black |
|------------------------|----------|
| 07-12 Wrangler, 3 Pcs. | 11232.21 |



See page J49 for NEW Rugged Ridge® Off-road lighting

RUGGED RIDGE® BODY ARMOR FOR 2007-12 WRANGLER

Get that offroad look with Rugged Ridge® Body Armor! Each Body Armor piece is constructed of black diamond plate UV treated thermoplastic for the coolest, toughest looking upgrade for your Jeep®. Each body Armor attaches to your Jeep® with ultra strong 3M tape to ensure a secure fit. Have a scratch or dent on your paint? Cover it up with Body Armor! Simply fill in the scratched area with touch-up paint [to prevent rust] and install the Body Armor. You have now repaired and upgraded! Available in individual pieces or complete styling "kits", so you can customize the look of your Jeep® the way you want.

COWL BODY ARMOR

Protect your cowl from mirror damage with Cowl Body Armor from Rugged Ridge®. Whenever your door limiter straps are disconnected the door can over extend causing damage to your cowl area. These new cowl covers protect your cowl area while providing a great look. Constructed of durable UV thermoplastic, these covers easily attach using 3M double sided automotive grade adhesive. Packed in pairs.

| Cowl Body Armor | Part # |
|---|----------|
| 07-12 Wrangler Matte Black, Pair NEW | 11651.18 |



11651.17 Hood Stone Guard



11651.01 Rear Corner Guards

11651.18 Cowl Body Armor

11651.05 Rocker Side Panel

Body Armor Components

- Rear Tall Corner, Pair *
- Rocker Side Panel, Kit *
- Hood Stone Guard, Each *

* May require modification to fit with Bushwacker brand rear fender flares.

| | 07-12 Wrangler 2-Door | 07-12 Wrangler 4-Door |
|--------------------------|--------------------------|--------------------------|
| Rear Tall Corner, Pair * | 11651.02 | 11651.01 |
| Rocker Side Panel, Kit * | 11651.06 | 11651.05 |
| Hood Stone Guard, Each * | 11651.17 | 11651.17 |

Body Armor Kits for 07-12 Jeep® Wrangler

| | Part # |
|---|----------|
| 07-12 Wrangler 2-Door, Kit † Rear Tall Corners, Pair [11651.02] Rocker Side Panel, Pair [11651.06] Hood Stone Guard [11651.17] | 11651.51 |
| 07-12 Wrangler 4-Door, Kit † Rear Tall Corners, Pair [11651.01] Rocker Side Panel, Pair [11651.05] Hood Stone Guard [11651.17] | 11651.50 |



REAR CORNER GUARDS BODY ARMOR



11651.02 Rear Corner Guards

11651.02 Rear Corner Guards

ROCKER SIDE PANEL BODY ARMOR



11651.05 Rocker Side Panel

HOOD STONE GUARD BODY ARMOR

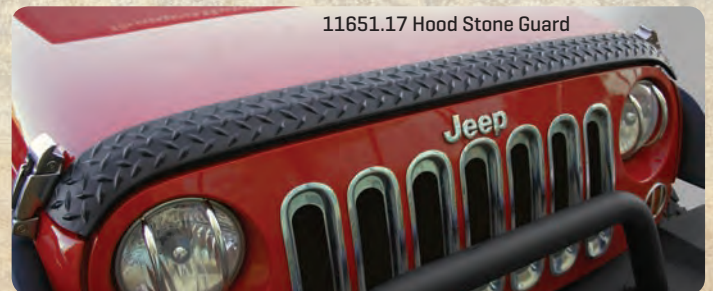

11651.17 Hood Stone Guard

All images are subject to be representative. More detailed information is available online.

Exterior Stainless Accessories

Get the ultimate WOW factor with Rugged Ridge® polished stainless steel accessories! These beautiful bolt on accessories turn even the most worn Jeep® into a hot street machine. Constructed of prime 304 stainless steel that has been polished to a mirror finish, these accessories are built to last. 304 stainless steel is virtually rust proof guaranteeing that these parts will stand the test of time. All hardware is also constructed of stainless steel so the polished look you are going for is complete. Rugged Ridge® offers the most complete line of stainless accessories so you can truly customize the look of your vehicle. When you want the best, look to Rugged Ridge® Stainless Accessories!

Wrangler 07-12

WINDSHIELD TIE DOWN KITS



11101.05

| Windshield Tie Down Kit | Part # |
|--|----------|
| 07-12 Wrangler, Stainless Kit (Footman loop, windshield bumper covers, washer cover) | 11101.05 |

HOOD CATCHES

Available in polished 304 Stainless Steel or Chrome, these catches will keep your Jeep's® hood in place regardless of how rough the ride gets!



11116.06 Hood Catch, 07-12 Wrangler

| Hood Catch, Stainless | Part # |
|---------------------------------------|----------|
| 07-12 Wrangler, Pair (Cast Stainless) | 11116.06 |

STAINLESS STEEL HOOD KITS



11101.04

| Hood Kit, Stainless | Part # |
|---------------------------|----------|
| 07-12 Wrangler, 7 pc. Kit | 11101.04 |
| Hood Vent, Stainless | Part # |
| 07-12 Wrangler | 11117.05 |

STAINLESS HINGE TREATMENTS FOR 2007-12 WRANGLER

These cast stainless design Hinge Treatments are guaranteed not to rust while providing a new beefy look. Door and Hood Hinge covers feature a easy-to-install design. Replacing your existing hinges can break & crack the surrounding paint, as the hinges were painted at the factory after installation. These covers retain the stock hinge but give it a new look without harming your expensive paint. A direct bolt on - no drilling required, fits either side. Use #11113.06 for 4-door models, #11113.05 for 2-door models and #11111.10 for hood.

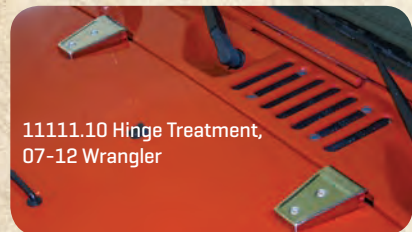

11111.10 Hinge Treatment, 07-12 Wrangler

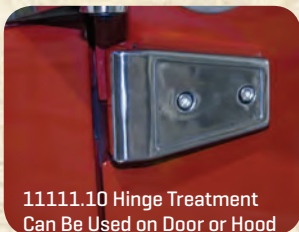

11111.10 Hinge Treatment Can Be Used on Door or Hood

| Hinge Treatment | Stainless |
|-------------------------------------|-----------|
| 07-12 Wrangler, Pair | 11111.10 |
| 07-12 Wrangler 2-Door Kit, 4 Hinges | 11113.05 |
| 07-12 Wrangler 4-Door Kit, 8 Hinges | 11113.06 |



Fast and easy installation on your door or hood hinges



STAINLESS HINGES FOR 2007-12 WRANGLER

Solid stainless steel can't be beat for longevity and that's why Rugged Ridge® now offers stainless steel hinges for the 07-12 Wrangler. These hinges are a direct bolt-on replacement for the stock units. Installation is easy with only simple hand tools. Both door and hood hinge sets are available for a complete vehicle makeover. Includes matching stainless steel hardware.



11111.22

| Stainless Steel Hinges for 07-12 Wrangler | Part # |
|---|----------|
| Door Hinge Kit, 07-12 Wrangler 2-Door, 4 Hinges | 11111.20 |
| Door Hinge Kit, 07-12 Wrangler 4-Door, 8 Hinges | 11111.21 |
| Hood Hinge Kit, 07-12 Wrangler, Pair | 11111.22 |



11111.21

STAINLESS & BILLET STYLE GAS HATCH COVERS

Create a custom look in just a few minutes. This special design fits directly over the existing gas cap opening. These tough gas covers are available in either stamped stainless steel, polished aluminum or chromed aluminum and are specially treated for resistance to gasoline and other chemicals. Unlike other designs on the market, installation does not require the removal of the tail light or internal gas cover components. For 2007-12 Wranglers the cover attaches directly to the original equipment plastic insert using self tapping screws with no need to remove the existing plastic insert. Available with or without locking mechanism. Please note that your factory gas cap is still required.

| Application | Finish | Part # |
|----------------------|---------------------------|----------|
| 07-12 Wrangler, Each | Stainless Steel | 11134.02 |
| 07-12 Wrangler, Each | Stainless Steel, Locking | 11134.03 |
| 07-12 Wrangler, Each | Chromed Aluminum | 11425.03 |
| 07-12 Wrangler, Each | Chromed Aluminum, Locking | 11425.04 |



11134.03

STAINLESS STEEL WINDSHIELD HINGES/BRACKETS

These hinges and brackets are one of those pieces that really shows off an attention to detail. They install quickly and easily and add a little bit of flash. Sold as a matching left/right hand pair. Includes all necessary hardware.



11112.03

| Stainless Windshield Hinges | Part # |
|--------------------------------|----------|
| 07-12 Wrangler, Pair - Bracket | 11112.03 |

MIRROR & MIRROR ARM COVERS

Give your JK Wrangler a unique look with these mirror and arm covers. Available in pairs as mirror covers, just the arms or a kit for both. Made from chrome plated ABS plastic, these pieces are an easy install, using pre-applied double-sided tape.



13311.02 Mirror Arm Cover



13311.01 Mirror Cover



13311.03 Mirror Cover Kit

| Mirror & Mirror Arm Covers | Part # |
|---|----------|
| Mirror Covers, Chrome, 07-12 Wrangler, Pair | 13311.01 |
| Mirror Arm Covers, Chrome, 07-12 Wrangler, Pair | 13311.02 |
| Mirror Cover Kit, Chrome, 07-12 Wrangler, 4 Piece Kit | 13311.03 |

WINDSHIELD LIGHT BRACKETS

Easily and quickly mounts to your factory windshield hinge creating two great spots for off-road lighting. Foam backing protects your vehicle's finish. No drilling required for installation. Sold in pairs with all mounting hardware.



11028.03



11028.03

Stainless Windshield Light Brackets (Pair)

| Part # | Part # |
|----------------|----------|
| 07-12 Wrangler | 11028.03 |

MIRROR RELOCATION BRACKETS

Custom designed brackets bolt into existing holes on the windshield, relocating your mirrors off the door. The perfect add-on accessory for those off-road adventures where you do not want your doors. The 07-12 Wrangler bracket kit comes with a Stainless filler plate to cover up the holes created when you remove your mirrors. *Fits 11-12 Wrangler models equipped with manual mirrors. Will not work with power mirrors.



Stainless Mirror Relocation Brackets (Pair)

| Part # | Part # |
|-------------------------------|----------|
| 07-12 Wrangler w/Filler Plate | 11026.04 |

ANTENNA BASE COVER

This chromed plastic antenna base cover is a quick and easy way to add a touch of flash to your 07-12 Wrangler. Simply unscrew your factory antenna and place the cover over the factory antenna base. Installation is easy thanks to the pre-attached durable double sided automotive grade tape.



Antenna Base Cover

| Part # | Part # |
|----------------------|----------|
| 07-12 Wrangler, Each | 13311.26 |

DOOR HANDLE COVERS/RECESS GUARDS

Compliments Your Exterior Stainless Accessories

Give your Jeep® a great new custom chrome look in just a few minutes! Made from triple chrome plated ABS plastic, these exterior trim pieces are designed to resist flaking and oxidation. Easy no drill installation! They install in seconds using pre-applied double-sided tape. Buy the Recess Guard and door handle kits for the ultimate look!



Chrome Door Handle & Recess Guard



Black Recess Guard, Factory Door Handle

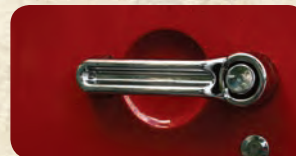

Chrome Door Handle Cover



Chrome Recess Guard, Factory Door Handle



Chrome Door Handle Cover

Door Handle Covers/ Recess Guards

| Part # | Part # |
|--|----------|
| Chrome Door Handle Covers, 2-Door, 07-12 Wrangler, 3 Pc. Kit | 13311.11 |
| Chrome Door Handle Covers, 4-Door, 07-12 Wrangler, 5 Pc. Kit | 13311.12 |
| Chroms Door Handle Cover Replacement Piece, 07-12 Wrangler | 13311.10 |
| Chrome Door Handle Recess Guards, 2-Door, 07-12 Wrangler, 3 Pc. Kit | 13311.15 |
| Chrome Door Handle Recess Guards, 4-Door, 07-12 Wrangler, 5 Pc. Kit | 13311.16 |
| Chrome Door Handle Covers & Recess Guard Kit, 2-Door, 07-12 Wrangler, 6 Pc. Kit | 13311.17 |
| Chrome Door Handle Covers & Recess Guard Kit, 4-Door, 07-12 Wrangler, 10 Pc. Kit | 13311.18 |
| Black Door Handle Recess Guards, 2-Door, 07-12 Wrangler, 3 Pc. Kit | 11651.25 |
| Black Door Handle Recess Guards, 4-Door, 07-12 Wrangler, 5 Pc. Kit | 11651.26 |

FRONT EURO-GUARDS

Protect those expensive headlights, turn signals and parking lights from impact with the Rugged Ridge® Euro Light Guards. Each Euro Light Guard is easy to install with no drilling required. They are of polished stainless steel for a true attention to detail.



Front Euro-Guards

| Part # | Part # |
|--|----------|
| 07-12 Wrangler, Headlight Guards, Pair | 11142.04 |
| 07-12 Wrangler, Parking Light Guards, Pair | 11142.11 |
| 07-12 Wrangler, Side Marker Light Guards, Pair | 11142.12 |
| 07-12 Wrangler, Fog Light Guards, Pair | 11142.13 |



REAR EURO-GUARDS

Protect and upgrade the look of your Jeep® with a set of Rugged Ridge® Euro Taillight Guards. Each Rear Euro Taillight Guard is easy to install with no drilling required. Rubber inserts around the mounting screws on 2007-12 models keep the metal Euro Guard off the taillight, preventing scratching and rattles.

Rear Euro Guards

| Part # | Part # |
|----------------------|----------|
| 07-12 Wrangler, Pair | 11103.03 |

GRILLE/BILLET GRILLE INSERTS

Durable UV treated inserts enhance the front of your Jeep®. Available in your choice of Black or Chrome with or without aluminum billet inserts, these inserts add great styling and a unique appearance. All Rugged Ridge® inserts easily install without drilling or tools. Just click them in and go! Add on the NEW black or stainless Euro-Guards or black headlight bezels for the sharpest look on the market!



11306.20 Chrome Grille Inserts



11401.20 Chrome w/Aluminum Billet Grille Inserts



Grille Inserts & Billet Inserts

Grille Inserts

Billet Inserts

2007-12 Wrangler, Set of 7

11306.20

11401.20

HOOD SCOOPS

Constructed of durable ABS plastic in 3 different finishes, these great looking Hood Scoops give your Jeep® an aggressive look! Each Hood Scoop has been designed to complement the lines of the Jeep® while enhancing airflow. Choose from three finishes; Smoke, polished chrome or textured black. Each attaches with tough automotive grade tape to ensuring a long life. Each scoop can be used with the opening facing the window or facing the front of the Jeep®, depending on your preference.

Air Scoop

Part #

| | |
|------------------------------|----------|
| 07-12 Wrangler, Chrome, Each | 11352.11 |
| 07-12 Wrangler, Smoked, Each | 11352.10 |
| 07-12 Wrangler, Black, Each | 11352.12 |



11352.11



11352.10



11352.12

COMPLETE THE LOOK!

Complete the look of your new Wrangler with these chrome accessories from Rugged Ridge®. These UV-treated chromed plastic accents attach to your vehicle with durable double sided tape; the same tape used in attaching complete body kits to vehicles!



A



B



C



D



E



F

Exterior Accessories for 2007-12 Wrangler, 2 and 4-Door

Part #

| | | |
|---|---|----------|
| A | Parking Light Trim, Chrome, 07-12 Wrangler, Pair | 13311.22 |
| B | Headlight Trim, Chrome, 07-12 Wrangler, Pair | 13311.20 |
| C | Fuel Filler Accent Trim, Chrome, 07-12 Wrangler | 13311.23 |
| D | Tail Light Covers, Chrome, 07-12 Wrangler | 13311.21 |
| E | Tailgate Hinge Covers, Chrome, 07-12 Wrangler | 13311.24 |
| F | Lift Gate Hinge Covers, Chrome, 07-12 Wrangler, w/Hardtop | 13311.25 |

Custom designed to protect the steering components on all 2007-12 Jeep® Wranglers, this overbuilt skid plate is a must for those off road adventures. Constructed of durable 1/4" powdercoated steel with a rust resistant E-Coating, this Skid Plate is designed to take whatever the trail throws at you! Designed to fit with all Rugged Ridge® front bumpers (looks amazing with the XHD Bumper system!) or all factory front bumpers, this skid plate provides protection for all front steering components including the very expensive electric sway bar disconnect system found on Rubicon models. Easy to install frame mount design incorporates special gussets and welded brackets to ensure long life and great off road performance.

FRONT SKID PLATE FOR 07-12 WRANGLER



| Front Skid Plate for 07-12 Wrangler | Part # |
|---|----------|
| Front Skid Plate- All RR bumpers, all factory original bumpers NEW | 18003.30 |

EVAPORATOR SKID PLATE

The Evaporator Skid Plate is constructed of durable 3/16" thick black powder coated steel, and mounts to existing body holes using the factory hardware. It helps transfer the load of an impact away from the evaporator tank and to the frame and cross member. Rugged Ridge® offers a wide variety of skid plates and body protection for Wranglers. You can wheel with confidence knowing these skid plates will help keep you from getting hung up on rocks, trail obstacles, while preventing damage to critical components.



| Evaporator Skid Plate | Part # |
|----------------------------------|----------|
| 07-11 Wrangler NEW | 18003.40 |
| 2012 Wrangler COMING SOON | 18003.41 |

MUFFLER SKID PLATE

The Muffler Skid Plate is constructed of durable 5mm thick black powder coated steel, and mounts to existing body holes using the factory hardware. It helps transfer the load of an impact away from the muffler and to the frame.



| Muffler Skid Plate | Part # |
|---------------------------|----------|
| 07-12 Wrangler NEW | 18003.31 |
| * For OE exhaust only. | |

HEAVY-DUTY DIFFERENTIAL COVERS

Indestructible! You won't break these covers, we guarantee it. Made of 3/8" cast steel, painted black inside and out, these heavy-duty covers are designed to protect your differential and all its working parts for as long as you own your vehicle. These indestructible covers have been "44 caliber tested" - if they can take a bullet at point blank range (don't try this at home!), they can take all that the trail has to offer. Available for most popular Dana differential types and include extra reinforcement protection for the fill plug area. All mounting hardware and instructions are included for easy of installation.

| Differential Cover | Part # |
|--------------------|----------|
| Dana 30, Each | 16595.30 |
| Dana 35, Each | 16595.35 |
| Dana 44, Each | 16595.44 |
| Dana 60, Each | 16595.60 |



TRANSFER CASE SKID PLATE



| Transfer Case Skid Plate | Part # |
|----------------------------------|----------|
| 07-12 Wrangler, Black NEW | 18003.32 |

HEAVY-DUTY DIFFERENTIAL SKID PLATES

Protect your factory differential cover with these heavy-duty skid plates. Designed to fit the contours of your stock differential cover. Constructed of durable 3/16" black powder coated steel, these skid plates will help you slide over obstacles and not get hung up. Includes replacement mounting hardware and instructions. Now available with the Jeep® logo stamped into the face as an Authentic Jeep® Licensed product.



| Heavy-Duty Differential Skid Plates | Part # |
|--|--------------|
| Dana 30 Diff. Skid Plate | 16597.30 |
| Dana 30 Diff. Skid Plate with Jeep® Logo | DMC-16597.30 |
| Dana 35 Diff. Skid Plate | 16597.35 |
| Dana 35 Diff. Skid Plate with Jeep® Logo | DMC-16597.35 |
| Dana 44 Diff. Skid Plate | 16597.44 |
| Dana 44 Diff. Skid Plate with Jeep® Logo | DMC-16597.44 |

CONTROL ARM SKID PLATES



Protect your control arms with these easy to install skid plates. Constructed of durable 3/16" black powder coated steel, these skid plates will help prevent getting hung up on rocks and other trail obstacles. Simply unbolt your control arm at the axle and slide this skid plate in place. Sold as a pair. Available for front and rear axles.

Sold as a pair. Available for front and rear axles.



| Control Arm Skid Plates | Part # |
|-----------------------------------|----------|
| 07-12 Wrangler, Front, Pair | 18003.35 |
| 07-12 Wrangler, Rear, Pair | 18003.36 |
| 07-12 Wrangler, Front & Rear, Kit | 18003.37 |

COMING SOON HEAVY DUTY ACCESSORIES

| Coming Soon | Part # |
|--|----------|
| 07-12 Wrangler, Engine & Transmission Skid Plate, Blk Powder Coat NEW | 18003.50 |
| 07-12 Wrangler, Frame Brace Kit NEW | 18205.25 |
| 07-12 Wrangler, Inverted Drag Link NEW | 18205.26 |



OFF ROAD JACK ROLL BAR MOUNTING BRACKET

Get your Hi Lift style jack out of the elements with this roll bar mounting kit from Rugged Ridge®. Storing your jack outside leaves it vulnerable to water, debris, ice and theft. These great new brackets allow you to secure your jack to the sports bar without sacrificing cargo area storage, and increase the longevity and function of your jack! The simple no drill installation allows for easy removal and storage of the jack.



Off Road Jack Roll Bar Mounting Bracket Part #

07-12 Wrangler **NEW** 11586.02

HEAVY DUTY TIRE SPACER

The Spare Tire Spacer bolts to your existing factory spare tire mount and relocates the tire two inches up and out. Both the HD Tire Carrier and Spare Tire Spacer feature 5x4.5" and 5x5.5" wheel bolt patterns and tough powder coated black textured finish. Caution: The tailgates on 07-12 Wrangler models are not designed to hold extra large tires. Therefore, do not use a tire larger than a 33x12.50" or equivalent tire with this spacer. If you want to carry a larger tire, we recommend using the XHD Rear Bumper with Tire Carrier.



Heavy-Duty Tire Carrier & Spacer

Part #

07-12 Wrangler, Textured Black, Each

11585.02

CAUTION: The tire carrier spacer is designed to fit tires 33" in diameter or less. Do not exceed these tire sizes

HOOD LOCK

Special design virtually disappears into the grille. Cam lock design keeps people out of the engine compartment of your Jeep®. These clever applications install in minutes. An upgraded internal lock cover keeps ice and debris from fouling the lock mechanism.

Hood Lock Kits

Part #

07-12 Wrangler, Each

11252.05



THIRD BRAKE LIGHT EXTENSION JK

The third brake light extension kit from Rugged Ridge is brake light solution JK owners have been waiting for. Our brake light extension kit is fully adjustable in 1" increments and works with the OE spare tire carrier and most aftermarket units as well! It is made from durable black powder coated steel. It moves the third brake light up above oversized spare tires from 33" to 42". Off road antenna mount or send flag mount integrated into design.

Third Brake Light Extension

Part #

Third Brake Light Extension, 07-12 Wrangler **NEW**

11546.23

OFF ROAD JACK MOUNT



JK Off-Road Jack Mount allows you to carry your Off-Road jack on the outside of your vehicle saving precious cargo space. Fast and easy bolt on installation. Compatible with stock and most aftermarket rear bumpers (without tire carriers) as well as Rugged Ridge® XHD rear bumper with or without tire carrier. Bracket is sturdy and secures the jack in two locations to eliminate any vibration noise during vehicle operation. Durable textured finish looks great. Fits most off-road style jacks including Hi-Lift™.

Each Jack mount incorporates a special round cutout for padlock use.



Fits All Original Equipment And Rugged Ridge® XHD Rear Bumpers

Quick Release Knob Allows For Easy Jack Attachment/Removal

Off Road Jack Mount

Part #

Off Road Jack Mounting Bracket, Hi-Lift Style, Jeep® Wrangler [JK] 07-12

11586.01

STAINLESS HEADERS FOR 2007-11 WRANGLER

Our custom Exhaust Headers are engineered to deliver improved performance. The 3.8L isn't a bad motor it just needs more air to "breathe" properly. Our headers increase exhaust gas exit velocity to move more air through the cylinder head's combustion chamber resulting in performance gains. They are constructed of 409 stainless steel to ensure a long operating life. Each complete kit includes manifolds, gaskets, hardware, clamps and easy to read instruction sheets.

NEW!



Stainless Steel Headers

Part #

07-11 Wrangler w/3.8L Engine, Each **NEW**

17650.53

STAINLESS STEEL CAT-BACK EXHAUST SYSTEM



NEW!

Open up your Jeep®'s exhaust with this great looking & long lasting polished stainless steel dual exhaust system. You'll get a mellow exhaust note that will set your rig apart while enjoying increased performance. The 2 1/4" mandrel bent pipes give

hot exhaust gases a smooth exit without the constrictions found in crush-bent pipes. This added flow decreases back pressure and will actually increase the horsepower of your 3.8L or 3.6L engine! This is a bolt-on system that installs after the catalytic converter to keep your emissions legal. The dual split exits feature slash cut and rounded oval tips for a tough look. Each kit includes all necessary mounting hardware for an easy bolt on installation.

Stainless Steel Cat-Back Exhaust System

Part #

07-12 Wrangler 2-Door & 4-Door, Kit **NEW**

17606.75



COMING SOON

MODULAR XHD SNORKEL

Dusty Trails Rides and Deep Water Fordings. –Anyone who takes their rig off-road is likely to encounter these conditions. The new Modular XHD Snorkel System from Rugged Ridge® relocates the venerable stock air intake location to help reduce dust clogged filters and the risk of hydro-locking your engine. It is also the first snorkel designed with the modular functionality of a Pre-filter Low Mount and Ram High Mount air intake design. Unlike other snorkels, you don't have to give up flexibility for functionality. Not only did we engineer our snorkel to allow the windshield to fold and doors to be removed, we built it for use with our dual battery tray, windshield light bar and windshield light mounting tabs... Because what good is having a snorkel to cross the river, if you have to leave your lights and the dual battery [to power your winch] on the other side?

The Modular XHD Snorkel System comes standard with the Pre-filter Low Mount. The Pre-filter Low Mount relocates the air intake to just below the windshield and draws cool air from outside the hot engine compartment. The optional Ram High Mount design allows the air intake to be extended up an additional 21" to the top of the windshield. The two air intake mounts are easily interchangeable to give you the modular functionality best suited to your needs. The system is manufactured from premium thermoformed plastic, mandrel bent aluminum and hi-temp silicone connection hoses. Built in manual drain valves channel away excess water to prevent it from entering the intake system. It installs with minor modification to the fender, but without the major cutting and surgery that other kits require. The new lower air cleaner box installs in place of the factory unit, so you don't have to "hack and tap". Just attached the factory upper air box, chose from the Pre-filter Low Mount or Ram High Mount design and go!

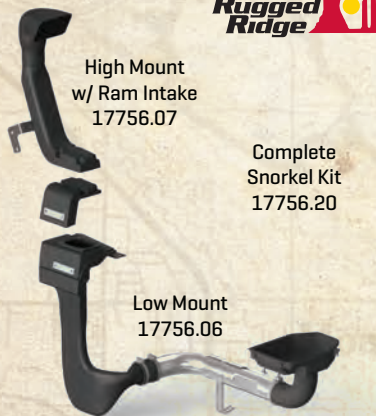

High Mount w/ Ram Intake
17756.07

Complete Snorkel Kit
17756.20

Low Mount
17756.06

- The modular design allows you to choose a Pre-filter Low Mount or Ram High Mount design.
- Works with other popular Rugged Ridge® accessories like: Dual Battery Trays, Windshield Light Bars & Windshield Light Mounting Tabs.
- Installs with minor modification of the fender. Unlike other kits that require cutting large holes in the firewall, fender or hood!
- Includes lower air cleaner box that seals and mates to the factory air intake.

Modular XHD Snorkel

| | Part # |
|--|----------|
| Modular XHD Snorkel Low Mount, 07-11 Wrangler 3.8L | 17756.06 |
| Modular XHD Snorkel High Mount w/Ram Intake, 07-11 Wrangler 3.8L | 17756.07 |
| Modular XHD Snorkel Kit*, 07-11 Wrangler 3.8L | 17756.20 |

*Includes Low Mount & Ram High Mount

2012+ 3.6L VERSION - IN DEVELOPMENT!

Want more horsepower, better throttle response, and improved acceleration?

A Rugged Ridge® Cold Air Intake System can boost your performance, while helping you keep extra cash in your wallet. Our polished aluminum mandrel bent intake tube replaces the restrictive factory air box to help improve fuel economy. A black powder coated heat shield separates the filter from engine heat, dirt and debris, as cold air is drawn through a high-flow conical air filter. Unlike other reusable air filters, our dry panel design never needs oiling, which keeps your mass airflow sensor from being damaged by excess oil! The simple bolt on installation gives you power you can feel, adding up to 10HP and 12ft lbs of torque, depending on application.

COLD AIR INTAKES FOR JEEP®



Rugged Ridge® Cold Air Intake Systems

| | Part # |
|--------------------------------|----------|
| 07-11 Wrangler 3.8L NEW | 17750.06 |

*See <http://www.fueleconomy.gov/feg/maintain.shtml>
** Depending on kit

17750.06 for 07-11 Wrangler 3.8L

RUGGED RIDGE® THROTTLE BODY SPACER FOR 2007-11 JEEP® WRANGLER



The Rugged Ridge® Throttle Body Spacer raises the throttle body 1/2" above the intake manifold. The lift helps optimize power and performance by drawing in colder denser air. The large bore design allows your system to inhale a larger volume of air producing more horsepower and torque. It features solid aluminum construction with a slick anodized black finish, and is a bolt on performance adder for 3.8L engines.

SYNTHETIC AIR FILTER

Unlike other reusable air filters, our dry panel design never needs oiling, which keeps your mass airflow sensor from being damaged by excess oil! Rugged Ridge® performance high flow filters are made from a synthetic fabric and not cotton. Cotton filters are made porous and must be oiled to trap dirt and debris. But that oil reduces air flow through the filter and it can become easily clogged. Our filters are woven from synthetic fabric to allow maximum air flow and particulate filtration. Because our filters never need oiling, they can be cleaned easily with water instead of degreaser, reducing the cost of maintaining the filter over the lifetime of your vehicle. No oil = No fuss, no mess and improved performance!



Throttle Body Spacer

| | Part # |
|--------------------------------|----------|
| 07-11 Wrangler 3.8L NEW | 17755.02 |

Air Filter

| | Part # |
|---|----------|
| Synthetic, Wrangler 07-11 3.8L and 2.8L Diesel, Wrangler 2012 3.6L NEW | 17752.05 |

All images are subject to be representative. More detailed information is available online.

RUGGED RIDGE® HEAVY DUTY 8,500 LB WINCH

- Durable 5.5 HP Series Wound motor for long life and extra pulling power
- Tough 3 stage planetary gear box with a 172.8:1 gear ratio delivering power and reliability
- Includes 94' of 5/16" diameter wire rope and latched hook
- Automatic load holding brake system (in the drum brake system)
- Exclusive light mount roller fairlead included- allows for easy no-drill mounting of up to 2 off road lights!
- Tough stainless hardware is used on the body of the winch to eliminate rust
- Each winch includes a durable 12' all weather cable remote solenoid box that can be mounted in multiple positions (over cable or over motor) and angles to accommodate most winch bumpers including the Rugged Ridge® XHD Bumper System!
- Limited 3 year warranty against manufacturing defects



Exclusive Light Mount Roller Fairlead included with both wire cable winches

8,500LB LINE SPEED & AMP DRAW-FIRST LAYER for Wire Cable and Synthetic Rope Winches

| Line Pull | Lbs | No Load | 2000 | 4000 | 6000 | 8000 | 8500 |
|---------------|--------|---------|------|------|------|------|------|
| Line Speed | Ft/min | 37.2 | 18 | 13.1 | 10.2 | 8.2 | 7.2 |
| Motor Current | amps | 70 | 190 | 260 | 335 | 410 | 425 |



8,500 LB. Heavy Duty Winch with Steel Cable | Part #
8,500 LB Heavy Duty Winch with Steel Cable | 15100.01

RUGGED RIDGE® HEAVY DUTY 10,500 LB WINCH

- Durable 6.6 HP Series Wound motor for long life and extra pulling power
- Tough 3 stage planetary gear box with a 218:1 gear ratio delivering power and reliability
- Includes 94' of 23/64" diameter wire rope and latched hook
- Automatic load holding brake system (in the drum brake system)
- Exclusive light mount roller fairlead included- allows for easy no-drill mounting of up to 2 off road lights!
- Tough stainless hardware is used on the body of the winch to eliminate rust
- Each winch includes a durable 12' all weather cable remote solenoid box that can be mounted in multiple positions (over cable or over motor) and angles to accommodate most winch bumpers including the Rugged Ridge® XHD Bumper System!
- Limited 3 year warranty against manufacturing defects

ALL WEATHER 12' CABLE REMOTE INCLUDED WITH ALL WINCHES

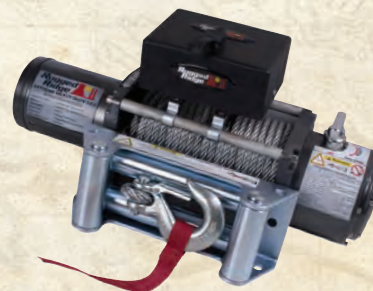

10,500LB LINE SPEED & AMP DRAW-FIRST LAYER for Wire Cable and Synthetic Rope Winches

| Line Pull | Lbs | No Load | 2000 | 4000 | 6000 | 8000 | 10500 |
|---------------|--------|---------|------|------|------|------|-------|
| Line Speed | Ft/min | 29.5 | 14.4 | 11.9 | 9.85 | 8.7 | 7.2 |
| Motor Current | amps | 70 | 170 | 240 | 310 | 380 | 425 |

10,500 LB. Heavy Duty Winch with Steel Cable | Part #
10,500 LB Heavy Duty Winch with Steel Cable | 15100.10



RUGGED RIDGE® SYNTHETIC ROPE PERFORMANCE WINCHES!

We have taken the high quality features of our regular winch and replaced the steel cable with genuine Dyneema SK-75 Synthetic Rope for a lighter weight, high performance winch option. The synthetic rope used on Rugged Ridge® winches is custom designed for heavy duty use and combined with the included polished aluminum hawse fairlead and 12' hook, will provide the ultimate in pulling power.

Rugged Ridge® 8,500 Synthetic Rope Winch- 11/32" x 100', Breaking Force 16,550lbs

- Constructed with Dyneema SK-75 fiber from the Netherlands.
- Same high strength fabric used in ballistic body armor.
- Significantly stronger than same diameter steel cable and up to 40% stronger than Kevlar.
- 1/7 the weight of the same diameter wire rope.
- Will not splinter, kink or curl like wire rope & floats in water.
- Specially coated to be resistant to UV, abrasions, and chemical solvents.
- Heavy Duty 11/32" 12-strand braid with a breaking force of 16,550lbs
- Hawse fairlead included

ALL WEATHER 12' CABLE REMOTE INCLUDED FOR ALL WINCHES



8,500 LB Performance Winch with Synthetic Rope | Part #
8,500 LB Performance Winch with Synthetic Rope | 15100.02

ALL RUGGED RIDGE® SYNTHETIC WINCHES INCLUDE AN ALUMINUM HAWSE FAIRLEAD



Rugged Ridge® 10,500 Synthetic Rope Winch-3/8" x 94', Breaking Force 19,310lbs

- Constructed with Dyneema SK-75 fiber from the Netherlands.
- Same high strength fabric used in ballistic body armor.
- Significantly stronger than same diameter steel cable and up to 40% stronger than Kevlar.
- 1/7 the weight of the same diameter wire rope.
- Will not splinter, kink or curl like wire rope & floats in water.
- Specially coated to be resistant to UV, abrasions, and chemical solvents.
- Heavy Duty 3/8" 12-strand braid with a breaking force of 19,310lbs
- Protective sleeves keep line from overheating on winch drum.
- Hawse fairlead included

10,500 LB Performance Winch with Synthetic Rope | Part #
10,500 LB Performance Winch with Synthetic Rope | 15100.11

WARNING: Read and understand all instructions and related Warnings, Cautions and Notices before attempting to install or use your Rugged Ridge® winch.

WHY SYNTHETIC WINCH ROPE?

Stronger and lighter, the two key elements of Synthetic Rope that make it the choice of competition off road vehicles everywhere. Rugged Ridge® high strength synthetic Winch Rope is constructed from genuine Dyneema SK-75 fiber imported from the Netherlands. This revolutionary fiber is the choice of off-road enthusiast worldwide. It is stronger and lighter than wire rope and never kinks or splinters! Our synthetic line is woven from twelve UV-treated strands, resulting in increased strength, and a power to weight ratio unmatched by wire rope. Each synthetic rope comes with a protective sleeve that prevents it from over heating on the winch drum, black powder coated latched hook, stainless steel thimble, and is pre-terminated end for ease of installation. Synthetic rope does not store energy like steel cables, and in the event of a failure it is much less likely to result in severe injuries caused by the whiplash of broken wire rope.

- Significantly stronger than same diameter steel cable and up to 40% stronger than Kevlar.
- Same high strength fabric used in ballistic body armor.
- 1/7 the weight of the same diameter wire rope.
- Will not splinter, kink or curl like wire rope & floats in water.
- Protective sleeves keep line from overheating on winch drum.



Synthetic Winch Rope

| | Part # |
|---|----------|
| Synthetic Winch Rope 11/32" x 100', Breaking Force of 16,550 lbs, Each NEW | 15102.10 |
| Synthetic Winch Rope 3/8" x 94', Breaking Force of 19,310 lbs, Each NEW | 15102.11 |

ALUMINUM HAWSE FAIRLEAD

This hawse fairlead will help guide the synthetic winch rope to and from the spool. Required for synthetic rope. Not recommended for steel rope.



Aluminum Hawse Fairlead

| | Part # |
|-------------------------------|----------|
| Aluminum Hawse Fairlead, Each | 11238.01 |

WINCH COVER

Keep your winch looking as good as the day you bought it with the Rugged Ridge® winch cover. Constructed of durable vinyl with reinforced grommets. Custom fit for Rugged Ridge® Winches



Rugged Ridge® Winch Cover

| | Part # |
|---|----------|
| Winch Cover, All Rugged Ridge® Winches NEW | 15102.02 |

*Will not fit UTV winches

WINCH CABLE HANDLE



NEW!

The winch hook handle is the perfect solution for handling a winch cable. It is constructed of tough nylon webbing with a molded sure-grip handle. Perfect for getting a good solid grip of the winch hook when free spooling cable for a recovery and a safe way to respool your cable without endangering your fingers. Just slip your winch hook through the nylon webbing and you are ready to rock!

Winch Cable Handle

| | Part # |
|-------------------------------------|----------|
| Winch Cable Handle, Each NEW | 15102.01 |

WINCH CABLE STOPPER



NEW!



Winch Cable Stopper

| | Part # |
|---|----------|
| Red, with Steel Cable or Synthetic Rope, Universal Application NEW | 15102.05 |
| Black, with Steel Cable or Synthetic Rope, Universal Application NEW | 15102.06 |

LIGHT MOUNT ROLLER FAIRLEAD

Turn your roller fairlead into an off road light mount! This revolutionary new design allows for two off road lights to be easily mounted while not interfering with the winch operation.



11238.03

Light Mount Roller Fairlead

| | Part # |
|--|----------|
| Light Mount Roller Fairlead, Each NEW | 11238.03 |

ROLLER FAIRLEAD LICENSE PLATE HOLDER



11238.05

If your state requires a front license plate, we have a solution for you. Instead of drilling holes in your bumper or risking not running a front plate, this easy to install license plate holder attaches to your winch roller fairlead. Simply bolt your license plate to the bracket and snap the holder in place. Your license plate is now securely mounted yet easily removable for winching.

Roller Fairlead License Plate Holder

| | Part # |
|---|----------|
| Roller Fairlead License Plate Holder, Each NEW | 11238.05 |



NEW!

DUAL BATTERY TRAY

Outfitting a trail rig can add greater strain to the electrical system. Adding on a winch, air compressor, fog lights, driving lights, a spot light, electric fuel pump, and a stereo amp can really tax the battery. A great way to combat that strain is to install dual batteries. This is especially true when using a winch, which can draw big amps for an extended period. These kits are designed to mount two batteries in place of the factory single battery location. The trays and brackets feature a black powder coated finish. These are mounting kits only and do not include any wiring. A suggested wiring diagram is included. The kit places the batteries side-by-side and may be used with lead acid or cylindrical-style sealed gel cell batteries.

Rugged Ridge® Dual Battery Tray

| | Part # |
|---------------------------------|----------|
| 07-11 Jeep® Wrangler NEW | 11214.53 |

DUAL BATTERY RELAY KIT



NEW!

The Rugged Ridge® Dual Battery Relay Kit is the perfect companion to the Rugged Dual Battery Tray. This relay kit allows you to connect two batteries to your electrical system. Because the last thing you want when your out of the trail or headed to the beach is a dead battery.

Rugged Ridge® Dual Battery Relay Kit

| | Part # |
|---------------------------------|----------|
| 07-12 Jeep® Wrangler NEW | 17265.01 |

RECOVERY GEAR

20,000 lbs Kit

- Durable Recovery Gear Bag.
- Heavy Duty 8" 20,000lb Snatch Block Pulley.
- Premium 2" x 30' 20,000lb Recovery Strap.
- Premium 3" x 6' 30,000lb Tree Trunk Protector Strap.
- Heavy Duty 9,500lb zinc coated pair of D-Rings.
- Winch Line Dampener.
- Pair of leather Recovery Gloves.

30,000 lbs Kit

- Durable Recovery Gear Bag.
- Heavy Duty 9" 30,000lb Snatch Block Pulley.
- Premium 3" x 30' 30,000lb Recovery Strap.
- Premium 3" x 6' 30,000lb Tree Trunk Protector Strap.
- Heavy Duty 13,500lb zinc coated pair of D-Rings.
- Winch Line Dampener.
- Pair of Leather Recovery Gloves.

The Rugged Ridge® Recovery Kit includes everything you need to help your buddy next time he gets stuck in the mud. The durable carrying case is filled with our most popular recovery products to make sure you can get out of those trouble spots quickly and safely. Each kit contains the following:



NEW!

Recovery Gear also sold separately.

Rugged Ridge® Recovery Gear Kit

Part #

| | |
|--|----------|
| 20,000 lb, Recovery Gear, Kit, Universal Application | 15104.25 |
| 30,000 lb, XHD Recovery Gear Kit, Universal Application NEW | 15104.28 |

Don't Need Everything In Our Recovery Kit? Customize Your Your Own And Get Just What You Need!

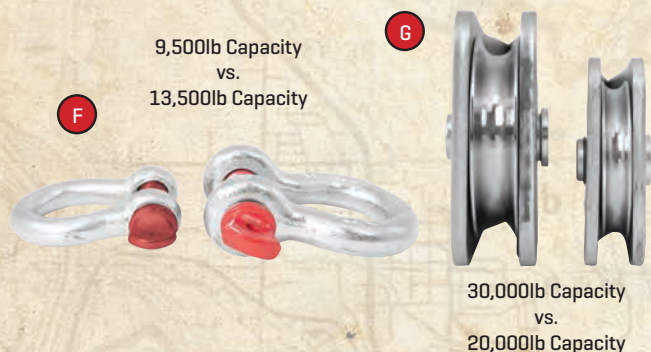

Rugged Ridge® Recovery Gear

Part #

| | |
|--|----------|
| A Recovery Strap 3" x 30' 30,000 lbs, Each NEW | 15104.01 |
| A Recovery Strap 2" x 30' 20,000 lbs, Each NEW | 15104.02 |
| A Recovery Strap 4" x 30' 40,000 lbs, Each NEW | 15104.03 |
| B Tree Trunk Protector, 3" x 6' 30,000 lbs, Each NEW | 15104.10 |
| B Tree Trunk Protector, 2" x 6' 20,000 lbs, Each NEW | 15104.11 |
| C Recovery Bag, Each NEW | 15104.40 |
| D Recovery Gloves, Pair NEW | 15104.41 |
| E Winch Line Dampener, Each NEW | 15104.43 |
| F Heavy Duty 9,500 lb Zinc Coated D-Rings, Pair NEW | 11235.01 |
| F Heavy Duty 13,500 lb Zinc Coated D-Rings, Pair NEW | 11235.03 |
| G Heavy Duty 8" 20,000 lb Snatch Block Pulley, Each NEW | 11235.10 |
| G Heavy Duty 9" 30,000 lb Snatch Block Pulley, Each NEW | 11235.11 |

TIRE REPAIR KIT

The Rugged Ridge® Tire Repair Kit is essential recovery gear for any road or trailside tire repair. The kit includes: 2 sturdy aluminum handles, 2 reamers, 2 needles, 2 Allen head wrenches, and 25 self vulcanizing tire plugs all self contained in a heavy duty storage case. Be prepared for what ever the trail throws at you!



OFF ROAD JACK HANDLE RETAINER STRAP

This handy Off Road Jack Handle Retainer Strap pulls taut to secure the jack handle to the jack and eliminates obnoxious rattles. Simply loop the strap around the jack handle and pull it tight and go! Fits most off road style farm jacks including Hi-Lift.



Rugged Ridge® Tire Repair Kit

Part #

| | |
|----------------------------------|----------|
| Tire Repair Kit, Each NEW | 15104.51 |
|----------------------------------|----------|

Off Road Jack Handle Retainer Strap

Part #

| | |
|---|----------|
| Universal Application, Black NEW | 13305.60 |
|---|----------|

TIRE DEFLATOR KITS

Fully inflated tires are great for the road and gas mileage, but they deliver a washboard ride on the trail. Air down your tires for a softer ride and more tread grip. Rugged Ridge® offers two great kits to fit your lifestyle and budget. This adjustable tire deflator kit is made from 100% brass and are fully adjustable in 3 psi. increments. Once you find your desired setting you can lock the deflators where they bleed to the same tire pressure each and every time they are installed. So, you can deflate your tires quickly before heading out on the trail. The keychain tire deflator kit is made from stainless steel and connect together onto a key chain for ease of use!

Rugged Ridge® Tire Deflator Kits

Part #

| | |
|--|----------|
| Adjustable Tire Deflator Kit, 4 Piece Kit NEW | 15104.53 |
| Keychain Tire Deflator Kit, 4 Pieces | 15104.50 |



TRI FOLD RECOVERY SHOVEL

The Rugged Ridge® Tri Fold Recovery Shovel is a fully functional collapsible shovel that features two serrated edges for cutting or digging. The heavy duty black powder coated body is 23 inches when open and folds to a mere 9 inches. It can be stowed easily in any vehicle, but is still rugged enough for the toughest of jobs. Includes durable storage case.

Rugged Ridge® Tri Fold Off Road Shovel

Part #

| | |
|--------------------------------|----------|
| Tri Fold Off Road Shovel, Each | 15104.42 |
|--------------------------------|----------|

HID LIGHTING

We mated the brilliance of High Intensity Discharge bulbs with the rugged construction of our traditional halogen off road lights. The result is more efficient and powerful beam better capable of illuminating the night sky. HID lights are 2½ times more powerful than halogen lights and draw 60% less current than a standard 100W fog light. Our 6" and 5" HID Lights are constructed with heavy duty stamped steel housings, and are available in corrosion resistant black or stainless steel finish. Rugged Ridge® lights feature waterproof connections, internal ballast, and a reinforced multi-directional mounting base. The lights are available individually or in kits containing a pre-terminated wiring harness, relay, impact resistant stone guards and illuminated dash switch.

- 5", 6", 7" HID light assemblies available.
- 12V 35W 4200K HID Bulb.
- Internal ballast - no external ignition ballast to install.
- 2½ times more powerful than halogen bulbs.
- Draws 60% less current than a standard 100W fog light.
- HID Lights include impact resistant stone guard.
- The average life of an HID bulb is 2000 hours, compared to 500-1000 hours for a halogen unit.



Lights are available individually. All include impact resistant stone guards



Kits include a pre-terminated wiring harness, relay and illuminated dash switch



15205.51



15206.01



15205.63

| HID Off Road Lighting | Single Light | 2 Light Kit w/ Wiring Harness | 3 Light Kit w/ Wiring Harness |
|--------------------------|--------------|-------------------------------|-------------------------------|
| 6" Round, Black | 15205.01 | 15205.51 | 15205.61 |
| 5" Round, Black | 15205.02 | 15205.52 | 15205.62 |
| 7" Round, Black, Plastic | 15205.03 | 15205.53 | 15205.63 |
| 5" Round, Black, Plastic | 15205.04 | 15205.54 | 15205.64 |
| 6" Round, Stainless | 15206.01 | 15206.51 | 15206.61 |
| 5" Round, Stainless | 15206.02 | 15206.52 | 15206.62 |

HALOGEN LIGHTING

Designed, engineered, and tested to stand up to the rigors of off road use, our lights are constructed with heavy-duty stamped steel housings, and crystal glass lenses set in shock absorbent weatherproof rubber gaskets. The brilliant 12V 100 watt halogen bulbs slice through fog, rain or snow to help illuminate the road even under the toughest conditions. Available in Round, Rectangular and Slim housings in either a black or stainless steel finish to best suit your application. Slim lights feature a narrow profile just 2 13/16" thick! This sleek design allows them to be mounted in places most lights won't fit. They are perfect for windshield and grille mount light systems. The lights are available individually or in kits containing a pre-terminated wiring harness, relay, impact resistant stone guards (white stone guards with stainless, black with black) and illuminated dash switch.



15207.51

| Rugged Ridge® Off Road Lights, 100W | Single Light | 2 Light Kit w/ Wiring Harness | 3 Light Kit w/ Wiring Harness |
|-------------------------------------|--------------|-------------------------------|-------------------------------|
| 6" Round, Black | 15207.01 | 15207.51 | 15207.61 |
| 5" x 7", Black | 15207.05 | 15207.55 | 15207.65 |
| 6" Slim, Black | 15207.10 | 15207.58 | 15207.68 |
| 6" Round, Stainless | 15208.01 | 15208.51 | 15208.61 |
| 6" Slim, Stainless | 15208.10 | 15208.58 | 15208.68 |

Slim lights feature a narrow profile - just 2 13/16" thick!



Rectangular lights give your vehicle a whole new look

| Halogen Light Accessories | Part # |
|---|----------|
| Off Road Light Cover, 6-Inch Black | 15210.53 |
| Off Road Light Cover, 6-Inch White | 15210.54 |
| Off Road Light Cover, 5x7-Inch Black | 15210.55 |
| Off Road Light Cover, 5x7-Inch White | 15210.56 |
| Off Road Light Cover, 6-Inch Black Slim | 15210.57 |
| Off Road Light Cover, 6-Inch White Slim | 15210.58 |
| Off Road Light Installation Harness, For Pair Of Lights | 15210.62 |
| Off Road Light Installation Harness, For Three Lights | 15210.63 |
| Halogen H3 Off Road Light Bulb, 100w Replacement | 15210.82 |
| Halogen H3 Off Road Light Bulb, 130w Replacement | 15210.83 |

Crystal glass lenses set in shock absorbent weatherproof rubber gaskets.



Each lights includes an impact resistant stone guard.

Multi-directional mounting base allows you to focus light where you need it the most.

HID LIGHT ACCESSORIES



15210.50



15210.81



15210.80

Accessories/Replacement Parts

| Accessories/Replacement Parts | Part # |
|--|----------|
| HID Lighting Covers, 7",Smoked | 15210.51 |
| HID Lighting Covers, 6",Black | 15210.50 |
| HID Lighting Covers, 5",Black | 15210.52 |
| HID Lighting Installation Harness for a pair of lights | 15210.60 |
| HID Lighting Installation Harness for three lights | 15210.61 |
| Replacement HID Bulb for 5" and 6" lights | 15210.80 |
| Replacement HID Bulb for 7" lights | 15210.81 |



ROCKER SWITCH HOUSING KIT

This housing kit allows you to mount 2, 3, or 4 switches to numerous dash locations by using a series of interlocking interchangeable pods.

Rocker Switch Housing Kit

| Rocker Switch Housing Kit | Part # |
|---|----------|
| Mounts 2,3 OR 4 Switches NEW | 17235.20 |
| Rocker Switch Housing Kit, Universal Application. Includes Four Interlocking Switch Housings and Four Different Color Rocker Switches | 17235.89 |



17235.20

ROCKER PANEL SWITCHES

- Rocker Style Switch.
- Heavy Duty Marine Grade surpasses OE Specifications.
- Available in four great colors: Red, Blue, Green and Amber.
- Switch illuminated in the "ON" Position.
- Three post terminal, 20-amp design works with most aftermarket accessories.

Rocker Panel Switches

| Rocker Panel Switches | Part # |
|-----------------------|----------|
| Rocker Switch Amber | 17235.01 |
| Rocker Switch Red | 17235.02 |
| Rocker Switch Blue | 17235.03 |
| Rocker Switch Green | 17235.04 |



17235.01

17235.03

17235.02

17235.04

LOWER CONSOLE SWITCH POD KIT

Rugged Ridge® Center Console Mount Switch Pod replaces your original equipment "filler plate" by simply popping the filler plate out and putting in the switch plate. Each plate will hold up to 4 switches and custom built for all 2007-2010 Jeep® Wranglers with an automatic transmission. This exciting new mounting plate looks great and places auxiliary switches in easy reach. Purchase the Switch Panel and 4 multi color Rocker Switches all together and save [See kit part number below.] Limited 3yr Warranty.



NEW!

Low Switch Panel Kit

| Low Switch Panel Kit | Part # |
|---|----------|
| 07-10 Wrangler w/ Automatic Transmission. Includes Switch Pod and Four Rocker Switches NEW | 17235.85 |

RUGGED RIDGE® A-PILLAR SWITCH POD

Looking for a handy place to mount your accessory switches that doesn't require cutting or other modifications? The Rugged Ridge® A-Pillar Switch Pod has premolded cutouts to allow you to mount up to four aftermarket switches in easy reach on the driver's side A-pillar, and out of the way of the shifter handle. Our Pillar Pod has the textured molded finish just like the factory plastic pillar cover it replaces. It snaps into place just like the OE!



A-Pillar Switch Pod

| A-Pillar Switch Pod | Part # |
|------------------------------|----------|
| Wrangler 07-10 LH NEW | 17235.56 |
| Wrangler 07-10 RH NEW | 17235.57 |
| Wrangler 11-12 LH NEW | 17235.58 |
| Wrangler 11-12 RH NEW | 17235.59 |

LOWER CONSOLE SWITCH POD

Rugged Ridge® Center Console Mount Switch Pod replaces your original equipment "filler plate" by simply popping the filler plate out and putting in the Switch Plate. Each plate holds up to 4 Switches. Custom built for all 2007-2010 Jeep® Wranglers with an Automatic Transmission. Limited 3 year warranty.



NEW!

Low Switch Panel Kit

| Low Switch Panel Kit | Part # |
|--|----------|
| 07-10 Wrangler w/ Automatic Transmission, Black, Mounts Four Switches NEW | 17235.55 |

A-PILLAR SWITCH POD KIT

Includes Switch Pod and Four Rocker Switches

A-Pillar Switch Pod Kit

| A-Pillar Switch Pod Kit | Part # |
|------------------------------|----------|
| Wrangler 07-10 LH NEW | 17235.86 |
| Wrangler 07-10 RH NEW | 17235.87 |
| Wrangler 11-12 LH NEW | 17235.88 |
| Wrangler 11-12 RH NEW | 17235.89 |



NEW!

FRONT BUMPER LIGHT BARS

Rugged Ridge® has engineered a durable and easy to install light bar that allows you to add auxiliary lighting to your factory Wrangler bumper. The light bar bolts to existing mounting holes and installs easily without cutting, drilling, or removing the bumper. With a few simple hand tools you will be able to install your light bar and mount up to three lights on your Jeep® while retaining your factory bumper. Lights not included.



11232.20, 2007-12 Wrangler



11138.20, 2007-12 Wrangler



Front Bumper Light Bars

| | Part # |
|---------------------------------------|----------|
| 07-12 Wrangler, Textured Black, Each | 11232.20 |
| 07-12 Wrangler, Stainless Steel, Each | 11138.20 |

WINDSHIELD HINGE LIGHT BRACKETS

Special black powder coated or polished stainless brackets mount directly to the windshield hinge of your Wrangler. Allows for easy mounting of auxiliary lighting. Each bracket is custom designed for an exact mount and 07-12 models include a rubber gasket to protect the paint during installation/removal. Sold in pairs. Lights not included.



11027.03

Windshield Hinge Light Brackets

| | Black | Stainless |
|---------------------------|----------|-----------|
| 07-12 Wrangler NEW | 11027.03 | 11028.03 |

MOUNT A SET OF DRIVING LIGHTS ON YOUR HOOD CATCHES

Rugged Ridge® offers a complete light solution for your 2007-12 Jeep® Wrangler with our NEW Hood Mount Off Road Light Kit. This innovative product mounts a pair of 3" 55-watt Halogen Lights directly to your factory hood latches without drilling or vehicle modification. Each Kit includes textured black powder coated brackets, two 3" Halogen lights, a pre-terminated extended wiring harness, relay and an adhesive mounted switch for a complete light solution.



Hood Mounted Off Road Light Kit 2007-12 Wrangler

| | Part # |
|--|----------|
| Hood Mounted Off Road Lights, 3" Black, 2 Light Kit w/ Wiring Harness NEW | 15207.70 |
| Spare Light for Hood Mounted Light Kit NEW | 15207.72 |

RUGGED RIDGE® JK WINDSHIELD LIGHT BAR

The Ultimate Light Bar for your Wrangler! This exciting new design has been created to give the durable look of a five tab light bar with features found nowhere else. Through extensive testing, this heavy duty light bar incorporates a special wind deflector below the light bar to dramatically reduce whistling and "buffeting" of your soft top. Each bar hugs the contour of your windshield providing a great look while not interfering with the use of your hard or soft top. Oversized 2" textured black tubing attaches to your windshield mounts with no drilling. Each Light bar has five light tabs for use with Rugged Ridge® Lighting options (fits up to five 7" lights). Each light bar has been specially developed to work with Rugged Ridge® Light mount brackets and/or Rugged Ridge® mirror relocation brackets. Special three piece design makes the packaging small for ease of shipping. This is truly the most advanced light bar on the market!

NEW!

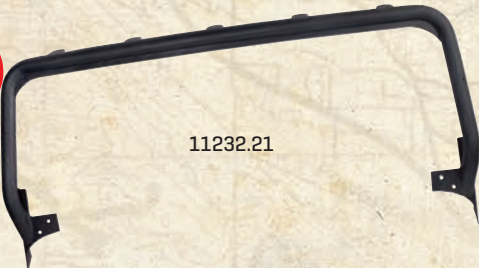

11232.21

Windshield Light Bar

| | Part # |
|--|----------|
| Textured Black, Jeep® Wrangler [JK] 07-12, Each NEW | 11232.21 |



XHD OVERRIDER LIGHT CLAMPS

Light mount brackets for use with XHD part numbers 11540.14, 11540.16 and any other 2'-2.5" bumper override/tubes. Easy mount design makes these a must for mounting Rugged Ridge® Lights to your bumper. Also available for smaller 1.5"-1.75" tube sizes. Sold as each.



Light Clamps

| | Part # |
|--------------------------------------|----------|
| 2"-2.5" Over Rider Mount Bracket New | 11503.82 |

OE JK FOG LIGHT

Stock replacement lens and housing assembly. Fits either side.

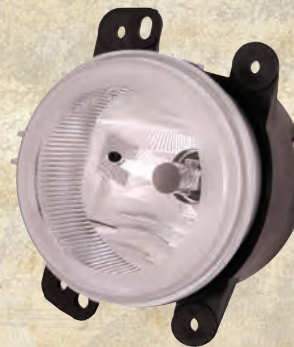

OE Fog Light

| | Part # |
|---|----------|
| Fog Light Assembly, Jeep® Wrangler [JK] 07-10 LH/RH | 12407.12 |

EUROGUARD KITS

Complete front and rear headlight and taillight protection packages now available! Get the complete look all in one package.



| Euroguard Kits | Part # |
|--|----------|
| Fog Lights, Black, 10 Piece, Wrangler [JK] 07-12 NEW Includes: Headlight, Side Marker, Turn Signal, Fog Light and Tail Light Guards | 12496.02 |
| W/o Fog Lights, Black, 8 Piece, Wrangler [JK] 07-12 NEW Includes: Headlight, Side Marker, Turn Signal, and Tail Light Guards | 12496.03 |
| Headlight Bezels and Grille Inserts, Black, 19 Piece, Wrangler [JK] 07-12 NEW Includes: Headlight, Side Marker, Fog light, Turn signal, Turn signal, Grille inserts and Headlight Trim | 12496.05 |
| Headlight Bezels and Grille Inserts, Black, 17 Piece, Wrangler [JK] 07-12 NEW Includes: Headlight, Side Marker, Turn signal, Turn signal, Grille inserts and Headlight Trim | 12496.06 |
| Fog Lights, Stainless Steel, 10 Piece, Wrangler [JK] 07-12 NEW Includes: Headlight, Side Marker, Turn Signal, Fog Light and Tail Light Guards | 12496.08 |
| Fog Lights, Stainless Steel, 10 Piece, Wrangler [JK] 07-12 NEW Includes: Headlight, Side Marker, Turn Signal, Fog Light and Tail Light Guards | 12496.09 |
| Headlight Bezels and Grille Inserts, Stainless Steel, 19 Piece, Wrangler [JK] 07-12 NEW Includes: Headlight, Side Marker, Fog light, Turn signal, Turn signal, Grille inserts and Headlight Trim | 12496.10 |
| Headlight Bezels and Grille Inserts, Stainless Steel, 17 Piece, Wrangler [JK] 07-12 NEW Includes: Headlight, Side Marker, Turn signal, Turn signal, Grille inserts and Headlight Trim | 12496.11 |



12496.05



12496.06



12496.02



12496.03



12496.08



12496.09

FRONT BUMPER LIGHT BAR KITS



| Front Bumper Light Bar Kits | Part # |
|---|----------|
| Bumper Mount HID Fog Kit , w 5-IN HID Fog Lights, 5 Piece, Black, Wrangler [JK] 07-12 NEW Includes: Bumper Light Bar, [3] 5-In HID Lights, and Wiring Harness with Switch | 12496.12 |
| Bumper Mount Slim Fog Kit , w Slim Fog Lights, 5 Piece, Black, Wrangler [JK] 07-12 NEW Includes: Bumper Light Bar, [3] 100 Watt Slim Lights, and Wiring Harness with Switch | 12496.13 |



12496.04



12496.12

12496.13

WINDSHIELD LIGHT MOUNT KITS



| Windshield Light Mount Kits | Part # |
|--|----------|
| Slim Fog Lights, 5 Piece, Black, Wrangler [JK] 07-12 NEW Includes: Black Windshield Light Mount Brackets, [2] 100 Watt Slim Lights & Wiring Harness w/ Switch | 12496.04 |
| 100 Watt Fog Lights, 5 Piece, Stainless Steel Mounts with Black Lights, Wrangler [JK] 07-11 NEW Includes: Stainless Windshield Light Mount Brackets, [2] 100 Watt Slim Lights & Wiring Harness w/ Switch | 12496.07 |



12496.07



11237.10 Lockable Spare Tire Mount Bike Carrier

LOCKABLE SPARE TIRE MOUNT BIKE CARRIER

This easy-to-use bike rack mounts to any emergency tire mounting studs. The bike rack carries 2 bikes directly off the spare tire. It is constructed of 2" powder coated steel tubing for maximum rust protection and durability. The bike clamp features rubber pads to protect your bike's finish. The carrier comes with 2 keys for the locking mechanism. Fits wheel off sets from 2-5/8" to 6". For All Jeep® Outside Spare Tire Applications

Bike Carrier

Spare Tire Mount Bike Carrier, Each

Part #

11237.10



Ball Mount Receiver Hitch

2" Square, Each

Part #

11237.02

2" RECEIVER HITCH

Includes clip and pin. Ball not included. For Jeep® use only. 2000-lb two rating, 200-lb tongue weight rating.

RECEIVER HITCH EXTENDER

Constructed from solid steel the extender lengthens your 2" receiver up to 12 inches! (Hitch mount accessories only - not tow rated)



Receiver Hitch Extender

12" Extender, Each **NEW**

Part #

11580.50

2007-12 WRANGLER RECEIVER HITCH

Custom design bolts directly to factory mounting points on the rear of the vehicle, very similar design to the OE Receiver Hitch. Durable powder coat design sheds water and provides a long lasting rust free finish. Includes cutout for factory wiring harness mounting. Designed as a one-piece welded assembly for added strength, we built our hitch receiver to match the towing capacity of your Jeep®. 3,500-lb tow rating, 350-lb tongue weight rating with weight distributing equipment; otherwise 2000-lb tow rating, 200-lb tongue weight rating, 2" opening.

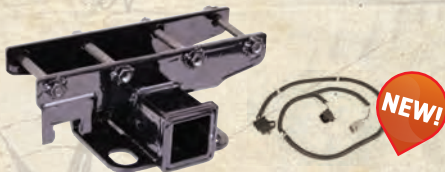

Receiver Hitch

07-12 Wrangler, Each

Part #

11580.10

Tow Wiring Harness

07-12 Wrangler, Each

Part #

17275.01

Hitch Kit Rear

Hitch & Wiring, 07-12 Wrangler **NEW**

Part #

11580.51

RECEIVER SHACKLE BRACKET



This heavy-duty steel design fits into any 2" receiver box. It is rated up to 9,500 lbs. pulling capacity on evenly distributed straight pulls. Note: never exceed your receiver capacity. Not designed for towing. Does not include hitch pin.

Receiver Shackle Bracket

All 2" Receivers, Each

Part #

11234.01*

*NEW 4-Color Packaging for 11234.01 is Part # 12680.13



HITCH BALL

Hitch Ball includes a matching mounting nut and lock washer. Pick from two standard sizes.

Hitch Ball Kit

2" x 3/4"

1-7/8" x 3/4"

Part #

11305.01

11305.02

RECEIVER TOW HOOK

Heavy-duty black powder coated tow hook inserts into any 2" style hitch (does not include hitch pin, not designed for towing).



Receiver Tow Hook

Fits All 2" Receivers, Each

Part #

11237.01



HOOD LIFT KITS

Eliminate the factory prop rod with a pair of gas charged hood lifts. This kit includes all the brackets and gas shocks needed to clean up the underhood appearance of your rig. This kit is also functional as the hood prop rod will no longer be in the way while working underneath the hood of your JK. Easy installation.



Hood Lift Kit

07-12 Wrangler, Kit

Part #

11252.51

Service Replacement Shock

07-12 Wrangler

Part #

11252.81

Designed by a dedicated team of Jeep® enthusiasts, the ORV™ suspension program is one of the most complete programs available. We have looked at each application in detail to provide the very best and most complete solution for your Jeep®. Since we focus the large majority of our attention on Jeep® vehicles, we know the ins and outs of what the best lift solution is depending on your individual needs. Below is a quick reference guide on the ORV™ program to make it easier to choose the lift you need for your particular need. Remember, all ORV™ Kits with shocks include a pair of neoprene wrapped grab handles and an Off Road Organizer for your glove box! **Welcome to ORV™ by Rugged Ridge®!**



Ken W.
Katterbach, Germany



Brian H.
Lansdale, PA



Dave G.
Flowery Branch, GA

A FEW WORDS ABOUT PRODUCT SAFETY.

Your safety and the safety of other motorists is very important. Your Jeep® is an off road capable vehicle that readily lends itself to restoration and customization. In considering modifications to your Jeep's® suspension you are the person choosing the combination of suspension, wheels, tires, drive train and accessories that best fit your intended use. Likewise, you are the person responsible for the safety and legality of the vehicle you modify. In modifying your vehicle's suspension, balance your desired off road capabilities against how the vehicle may actually be used off road and on road.

It is not practical or possible to warn about all hazards associated with your Jeep® or modifying your suspension for improved off road capabilities. Start by familiarizing yourself with all vehicle manufacturers' instructions, warnings limited warranties and the instructions and warnings accompanying your aftermarket product.

To help you make informed decisions about safety; this catalog and the instructions accompanying our products have provided certain information in the form of "Notices" and "Warnings". This information alerts you to potential hazards that could hurt you or others.

NOTICE

This is a caution against anything which may cause damage to the vehicle or its equipment if the caution is ignored. The Notice includes information about how you can avoid or reduce those risks.

WARNING

This is a signal telling you that you CAN be KILLED or SERIOUSLY HURT if you don't follow the Warning. The Warning includes information about what you must or must not do in order to reduce the risk of injury to yourself and others.

CAUTION

This is a signal telling you that you or others CAN be HURT if you don't follow the instruction. The Caution includes information about how you can avoid those risks.

WARNING HIGHER ROLLOVER RISK

Modifying the suspension of your vehicle to improve off road capabilities involves certain risks. The modified vehicle may handle differently than as factory equipped including increased ride-height; reduced lateral stability and risk of roll-over or other accident. Also, owner's choice of larger tire and wheel combinations may require additional braking force or increased stopping distances.

- Failure to drive this vehicle safely may result in serious injury or damage. Avoid sharp turns or abrupt maneuvers. Do not drive the vehicle under any speed or maneuvering conditions which may cause the vehicle to trip, roll, lose traction or compromise your ability to safely brake in an emergency.
- Familiarize yourself with all vehicle manufacturers and Rugged Ridge® warnings, instructions and limited warranties before driving this modified suspension vehicle. Follow recommended maintenance procedures and routinely inspect your vehicle components for unusual wear or off road damage.
- Rugged Ridge® does not recommend combined use of body lifts with suspension or other lift devices or modification, alteration or fabrication of any Rugged Ridge™ suspension product to achieve additional lift. Also be aware that most states have restrictions on height modifications for vehicles used on road. Consult your vehicle owners manual, limited warranties, the instructions and warnings accompanying this product and state law before undertaking these modifications or using your modified suspension vehicle on road. A summary of current regulations affecting modified suspension vehicles is available from www.SEMA.org.
- Always wear seat belts and/or appropriate off road restraints, reduce your speed, tread lightly® and safely enjoy your off road vehicle.



What to Buy:

When looking at which kit is best for your application you need to determine two important things: size of tire and use of vehicle. On the 2007-12 Wrangler JK, 2.5-3.5" coil kit is designed for up to a 34" x 12.5" x 16" tire and moderate off road use. The 4"-5" coil kit is designed for more severe off road use and up to a 35" x 12.5" x 16" tire.

ORV™ 2.5"-3.5" Coil Spring Lift - With shocks part # 18415.50

- The most complete kit available on the market for JK.
- Includes four powder coated, E-coated 5160H hot rolled bar, 5/8" coil springs that are set to factory rates.
- By using 5160H hot rolled bar, the ORV™ Springs keep their memory, eliminating any possibility of future sag.
- Setting coil springs to factory rates gives you the best on road ride possible and the ability to use a larger tire.
- Each kit includes a rear track bar brace to strengthen the original track bar mount. An ORV™ exclusive!
- 4-Door JK's will get on average a 2.5" lift. Two door models will get up to a 3.5" lift. All lifts are dependent on specific Jeep® characteristics and additional parts being put on the vehicle [bumpers, winch, hard tops, soft tops etc.].
- ORV™ kits with shocks include a pair of Neoprene Wrapped Grab Handles and an Off Road Organizer!



JK 2.5"/3.5" Lift Kit

ORV™ 4"-5" Coil Spring Lift - With shocks part # 18415.60

- Get off road performance while not sacrificing on road ride.
- Includes 4 powder coated, E-coated 5160H hot rolled bar 5/8" coil springs, set to factory rates for longer life and better ride!
- Each kit includes a rear track bar brace to strengthen the original track bar mount. A must for off road performance on a JK.
- Kit includes sway bar disconnects for more articulation off road.
- ORV™ uses tough, over built extended control arms for added strength and higher performance. Each arm has a beefy 3/16" wall thickness and each end is tapered before welding. This extra heavy-duty design ensures a long life both on and off road.
- In most cases control arms are longer than factory to adjust for caster. This is not always true for other brand lifts! Each arm bushing can be easily greased without removing the arm from the vehicle.
- 4-Door JK's will get on average a 4" lift. Two door models will get up to a 5" lift. All lifts are dependent on specific Jeep® characteristics and additional parts being put on the vehicle [bumpers, winch, hard tops, soft tops etc.].
- Due to the changed pinion angle, we highly recommend a new drive shaft be installed when using any 4" or greater lift kit on a 4-Door Wrangler. A new drive shaft will be required on any 2007-12 2-Door Wrangler due to the shorter wheel base.
- All 4" Kits require a drop pitman arm.
- ORV™ kits with shocks include a pair of Neoprene Wrapped Grab Handles and an Off Road Organizer!



JK 4"/5" Lift Kit



18006.55 Pitman Arm

07-12 Jeep® Wrangler JK/Rubicon, 4WD [2 & 4-Door models]

| | Kit w/o Shocks | Kit w/ Shocks | Max Tire Size HxWxD | Max Wheel Offset | Est. Install Time |
|--|----------------|---------------|---------------------|------------------|-------------------|
| 2.5"-3.5" Lift, 07-12 Jeep® Wrangler, 2 & 4-Door | 18401.50 | 18415.50 | 34"x12.5"x16" | 4.5" | 6 Hrs |
| 4"-5" Lift, 07-12 Jeep® Wrangler, 2 & 4-Door* | 18401.60 | 18415.60 | 35"x12.5"x16" | 4.5" | 8 Hrs |

Note: due to vehicle weight, the 2-Door models may receive an additional 1" lift over 4-Door models

* Will require a drop pitman arm 18006.55. Sold Separately

18401.50 Kit includes: (4) coil springs, rear track bar bracket, rear bump stop bracket, rear track bar brace, hardware kit

18401.60 Kit includes: (4) coil springs, (2) lower front links, (2) lower rear links, (2) rear bump stop brackets, (2) rear bump stop spacers, front track bar bracket, rear track bar bracket, (2) front double disconnect end links, (2) rear extended sway bar end links, rear track bar brace, hardware kit

CAUTION!
CAUTION: Rugged Ridge® recommends use of wheel spacers with all suspension lifts to reduce risk of roll over or other accident associated with modifying ride height for increased off road capabilities. See additional product safety information and WARNINGS at back of catalog.

COIL SPRING KITS

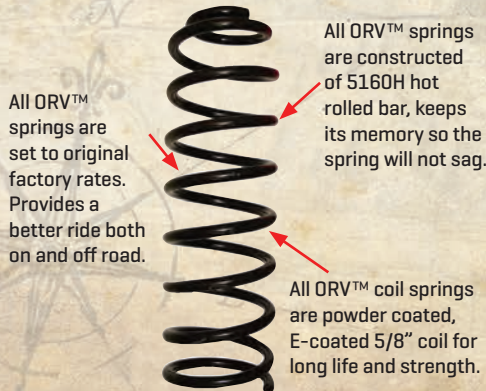

POLY BUSHINGS

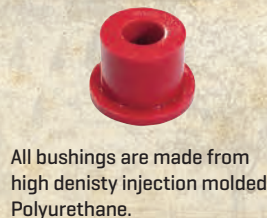

END LINKS



BRACKET/BRACES



KNOW YOUR ORV™ KIT

All images are subject to be representative. More detailed information is available online.

ORV™ SHOCKS

ORV™ only uses nitrogen charged gas shocks for all their kits. Though a little more money, the nitro gas shock in combination with the ORV™ kits provide a better ride both on and off road. By using an ORV™ lift kit and matching gas shocks, you optimize the suspension's capabilities giving you a better ride both on and off road. Another advantage to Nitro gas shocks is their ability to prevent body roll. This is extremely important, as body roll will kick in the ESP sensors on later model Jeeps®, which will shut the vehicle down.

ORV™ shock features include:

- 150 PSI pressurized Nitrogen gas
- Internal valving - the internal orifice will rotate when the piston moves more than 2" - automatically adjusts to make the ride as smooth as possible
- Twin tube construction to lower heat build up and protect the shock from off road obstacles
- Constructed to ORV™ specifications by a leading Shock manufacturer
- Bonded Iron 14mm piston with extra chroming - provides for a longer, rust free life
- Includes polyurethane bushings and a black shock boot
- Limited lifetime warranty on the shocks



ORV™ Shocks

| | Front | Extended | Collapsed | Rear | Extended | Collapsed |
|---|----------|----------|-----------|----------|----------|-----------|
| ORV™ Nitrogen Series Shock, 07-12 Jeep® Wrangler 2-Door, 3.5" Lift, 07-10 Wrangler 4-Door 2.5" Lift | 18465.09 | 22.75" | 13.54" | 18465.10 | 25.35" | 15.05" |
| ORV™ Nitrogen Series Shock, 07-12 Jeep® Wrangler 2-Door, 5" Lift, 07-10 Wrangler 4-Door 4" Lift | 18465.11 | 26.79" | 15.56" | 18465.12 | 28.38" | 16.65" |

COLORED SHOCK BOOTS

Add a splash of color to your rig with colored shocks boots from Rugged Ridge®. These durable shock boots keep mud and debris from prematurely ruining your shocks and they look great too! Works on ORV™ Nitrogen Shocks and most other brands as well! Sold each.



ORV™ Shock Boots

| | Part# |
|--|----------|
| Shock Boot, Black, ORV™ Suspension, Universal Application NEW | 18479.50 |
| Shock Boot, Red, ORV™ Suspension, Universal Application NEW | 18479.51 |
| Shock Boot, Blue, ORV™ Suspension, Universal Application NEW | 18479.52 |

ORV™ STEERING STABILIZERS

ORV™ recommends upgrading your current steering stabilizer or adding a stabilizer on all lifted Jeep® vehicles. The ORV™ Steering stabilizer dampens out the roughness of the highway and the vibration from running larger tires and wheels. ORV™ Hydraulic Stabilizers also make it easier to move those larger tires and wheels both on and off road. These noticeable handling improvements are well worth the small investment!



ORV™ Steering Stabilizers

| | Part# |
|--|----------|
| ORV™ Hydraulic Series Steering Stabilizer, 07-12 Jeep® Wrangler 2 & 4-Door | 18475.03 |



CV EQUIPPED DRIVE SHAFTS FOR 07-12 WRANGLERS

Reduce or eliminate driveline vibration with a CV-equipped driveshaft. Constant Velocity (CV) joints use two U-joints (double cardan style) in the place of a single U-joint. This smooths out the driveline angle and reduces vibration due to extreme lifts or driveline changes. Works with stock to 6" lift.

CV Equipped Drive Shafts

| | Part # |
|--------------------------------|----------|
| 07-12 Wrangler, Front 2/4-Door | 16592.22 |
| 07-12 Wrangler, Rear 2-Door | 16592.21 |
| 07-12 Wrangler, Rear 4-Door | 16592.20 |



16592.21 CV Equipped Rear Drive Shaft for 07-12 Wrangler 2-Door

ORV™ SUSPENSION SYSTEMS BY RUGGED RIDGE® LIMITED LIFETIME WARRANTY

Your Omix-Ada® /Rugged Ridge® product is covered by the Lifetime Limited Warranty explained below that gives you specific legal rights. This limited warranty is the only warranty Omix-Ada® /Rugged Ridge® /ORV™ makes in connection with your product purchase. Parts sold by Omix-Ada® or Rugged Ridge® but supplied by other vendors are exclusively warranted by the vendor supplying the part. Omix-Ada® neither assumes nor authorizes any vendor, retailer or other person or entity to assume for it any other obligation or liability in connection with this product or Limited Warranty.

What is covered? Subject to the terms, exclusions and limitations herein and with respect only to products first sold in the United States, Omix-Ada® warrants to the initial retail purchaser only that its Rugged Ridge® suspension kits, and ORV™ shocks and stabilizers shall be free of defects in material and workmanship for so long as the initial retail purchaser owns the vehicle on which these products were originally installed. All other express or implied warranties are hereby disclaimed. Your warrantor for these parts is Omix-Ada®, Inc., 460 Horizon Dr., Suite 400 Suwanee, GA 30024. Omix-Ada® reserves the rights to: [a.] require proof of purchase as a condition of this Limited Warranty, [b.] make future revisions to its Limited Warranty without prior notice.

What is not covered? Your Omix-Ada® /Rugged Ridge® /ORV™ Limited Warranty does not cover any Rugged Ridge® /ORV™ suspension systems that are used or combined with non-ORV™ suspension components. Furthermore, ORV™ suspensions not installed with ORV™ or other recommended shock absorbers may void the Limited Warranty. Products that wear out or fail due to the use of larger tires or wheels are not covered by this Limited Warranty. Your Omix-Ada® Limited Warranty further does not cover products or parts supplied to Omix-Ada® by outside vendors or products, parts or vehicles Omix-Ada® determines to have been damaged by or subjected to: Installation damage, alteration, modification or failure to maintain.

- Normal wear and tear (bushings, tie-rod ends, etc.). Scratches or defects in product finishes (powder coating, plating, etc.) or damage due to shipping.
- Damage arising or related to non- Omix-Ada® /Rugged Ridge® /ORV™, including but not limited to any vehicle's electronic stability system, related components or other vehicle systems.
- Racing or other vehicle competitions or contests. Accidents, impact by rocks, trees, obstacles or other aspects of the environment.
- Theft, vandalism or other intentional damage.
- Products used in application other than those recommended in the current /Rugged Ridge® /ORV™ catalog or the instructions accompanying your Rugged Ridge® /ORV™ product.

Remedy Limited to Repair / Replacement. The exclusive remedy provided hereunder shall, upon Omix-Ada® inspection and at Omix-Ada®'s option, be either repair or replacement of product or parts covered under this Limited Warranty. Customers requesting warranty consideration on Omix-Ada® branded parts (including Rugged Ridge® and ORV™) should first contact the independent distributor from whom you purchased your part to obtain a Returned Goods Authorization number. All removal, shipping and installation costs are customer's responsibility. Customers requesting warranty consideration on non-Omix-Ada® branded parts should refer to the manufacturers' Limited Warranty and contact them directly. If a replacement part is needed before the Omix-Ada® part can be returned, you must first purchase the replacement part. Then, if Omix-Ada® deems the part warrantable, you will be credited the purchase price.

Other Limitations - Exclusion of Damages - Your Rights Under State Law

- In consideration of the purchase price paid, neither Omix-Ada® nor any independent Omix-Ada® distributor/licensee are responsible for any time loss, rental costs, or for any incidental, consequential, punitive or other damages you may have or incur in connection with any part or product purchased. Your exclusive remedy hereunder for covered parts is repair/replacement as described above.
- This Limited Warranty gives you specific rights. You may also have other rights that vary from state to state. For example, while all implied warranties are disclaimed herein, any implied warranty required by law is limited to the terms of Limited Warranty described above. Some states do not allow limitations of how long an implied warranty lasts and /or do not allow the exclusion or limitation of incidental or consequential damages, so the limitations and exclusions herein may not apply to you.



Chantelle K.
Lusby, MD



Ricky T.
Birmingham, AL

©Omix-Ada®, Inc. 10.1.2011.
All Rights Reserved.

All images are subject to be representative. More detailed information is available online.

DRIVETRAIN ENGINEERING PERFECTED

Are you looking for an axle or ring and pinion rugged enough to match your off the beaten path sense of adventure? Alloy USA® axle shafts and Precision Gear® ring & pinions have been propelling muscle cars, trucks and four wheel drive vehicles down highways, drag strips, back roads and over the world's roughest terrain for nearly a decade. With the recent asset and intellectual property purchase of Alloy USA® and Precision Gear® by Ultra Axle LLC, an affiliate of Omix-Ada® Inc., these two brands are now backed by an industry leading, financially strong company that will be there for you in the long haul. As a member of the Omix-Ada® group of companies Alloy USA® and Precision Gear® will provide the service and support you demand!

The dedicated team of Alloy USA® and Precision Gear® engineers have developed, tested, raced and trail ridden each of our products until they were perfected. We marry the mechanics of engineering with the art of manufacturing to produce the finest in drivetrain solutions. High tensile strength 4340 Chromoly is heat-treated, tempered and induction hardened to produce these heavy-duty axles that are up to 40% stronger than stock. We use the latest splining technology to produce splines that are stronger than traditional cut splines. The shafts are then precision CNC machined and magnaflux inspected for cracks before receiving the Alloy USA® logo and a slick black anodized or natural finish.

Why have we put so much time and energy into developing our Axle Shafts and Ring & Pinions? Because horsepower is useless if you can't get it to the ground. We take pride in engineering solutions and prove it by backing each product with an industry leading warranty. Each axle is covered by our exclusive 10-year limited warranty and each ring and pinion is covered by a 5-year limited warranty so you can drive with confidence!



THE BEST WARRANTY IN THE BUSINESS

Alloy USA®/Precision Gear® Limited Warranty

Your Alloy USA® or Precision Gear® product is covered by the Limited Warranty explained below that gives you specific legal rights. This limited warranty is the only warranty Ultra Axle® LLC (the distributor/warrantor of these products) makes in connection with your purchase. Ultra Axle® LLC neither assumes nor authorizes any vendor, retailer or other person or entity to assume for it any other obligation or liability in connection with its products or Limited Warranty.

What is covered? Subject to the terms, exclusions and limitations herein and with respect only to products first sold in the United States, Ultra Axle® LLC warrants to the initial retail purchaser only that products sold under its Alloy USA® and Precision Gear® trademarks including Axle Shafts, Ring and Pinions, Installation Kits, Jeep® Overhaul Kits, Alloy USA® X Joints and Differential Covers shall be free of defects in material and workmanship for the Limited Warranty term/duration described below. This Limited Warranty shall be measured from the date of initial retail purchase, extends only to the initial retail purchaser and is not transferable. All other express or implied warranties are hereby disclaimed. Your warrantor for these parts is Ultra Axle® LLC, 460 Horizon Dr., Suite 400 Suwanee, GA 30024 (770-614-6101). Ultra Axle® reserves the right to: [a.] require proof of purchase as a condition of this Limited Warranty, [b.] make future revisions to its Limited Warranty without prior notice.

Duration of Limited Warranty by Product Line

Alloy USA®, front and rear axles- **10 Year Limited Warranty**

Precision Gear® and Alloy USA® Ring and Pinions- **5 Year Limited Warranty**

Jeep® Overhaul kits, Alloy USA® X Joints, Tube Seals, Differential Covers, Differential Cable Lock Kits, Wheel Spacers, Transfer Chain Kits, Yoke Conversion Kits & Hub Conversion Components - **3 Year Limited Warranty**

What is not covered: Your Alloy USA®, Precision Gear® Limited Warranty does not cover damage or claims to any component, vehicle or person other than Alloy USA® or Precision Gear® parts purchased by the initial retail purchaser. Your Alloy USA®, Precision Gear® Limited Warranty does not cover damage or claims to any component, vehicle or person Ultra Axle® LLC determines to have been damaged by or subjected to:

- Installation damage, alteration, modification, misuse or failure to maintain.
- Products used in application other than those recommended in the current Alloy USA®/Precision Gear® catalog or the instructions accompanying your Alloy USA® Precision Gear® product.
- Normal wear and tear/product life deterioration, scratches or defects in product finishes (powder coating, plating, etc.) or damage due to shipping.
- Damage arising or related to non- Ultra Axle® LLC products including but not limited to any vehicle's electronic stability system, related components or other vehicle systems.
- Accidents, impact by rocks, trees, obstacles or other aspects of the use environment.
- Theft, vandalism or other intentional damage.

Remedy Limited to Repair / Replacement. The exclusive remedy provided hereunder shall, upon Ultra Axle® LLC inspection and at Ultra Axle® LLC option, be either repair or replacement of the Ultra Axle® LLC parts covered under this Limited Warranty. Customers requesting warranty consideration should first contact the independent distributor selling your part to obtain a Returned Goods Authorization number. All removal, shipping and installation costs are customer's responsibility. If a replacement part is needed before the Ultra Axle® LLC part can be returned, you must first purchase the replacement part. Then, if Ultra Axle® LLC determines the part warrantable, you will be credited the purchase price of that part.

Other Limitations - Exclusion of Damages - Your Rights Under State Law

- In consideration of the purchase price paid, neither Ultra Axle® LLC nor any independent distributor are responsible for any loss of use or time, rental costs, or for any incidental, consequential, punitive or other damages you may have or incur in connection with your vehicle or any Ultra Axle® LLC product. Your exclusive remedy for Ultra Axle® LLC parts covered hereunder is repair/replacement as described above.
- This Limited Warranty gives you specific rights. You may also have other rights that vary from state to state. For example, while all implied warranties are disclaimed herein, any implied warranty required by law is limited to the duration and other enforceable terms of Limited Warranty described above. Some states do not allow limitations of how long an implied warranty lasts and /or do not allow the exclusion or limitation of incidental or consequential damages, so the limitations and exclusions herein may not apply to you.

© Ultra Axle® LLC Axle LLC. 1.3.2010. All Rights Reserved. Jeep® is a registered trademark of Chrysler LLC. Ultra Axle® LLC is an independent aftermarket vendor not affiliated with any vehicle manufacturer. Pro Gear® and Ultralite Gears and Differentials® are additional trademarks of Ultra Axle® LLC.

Chrysler®, Chevrolet®, Dodge®, GM®, Ford®, Jeep®, International® & other names used here are trademarks of their respective owners and are used within this publication for identification purposes only. Alloy USA® is not affiliated with these companies. The information in this catalog is believed to be correct at the time of publishing. The publisher is not responsible for any losses, direct or indirect, that are the result of any information within this publication. Alloy USA® and Precision Gear® and their corresponding logos are trademarks of Ultra Axle®, LLC. OMI-X-ADA® and its corresponding logo are registered trademarks of OMI-X-ADA®, Inc.

®Registered 2010, Ultra Axle®, LLC, all rights reserved.





Wrangler 07-12

FRONT AXLE KITS

High tensile strength 4340 Chromoly is heat-treated, tempered and induction hardened to produce these heavy-duty axles that are up to 40% stronger than stock 1040 axles. Each axle shaft is backed by Alloy USA®'s exclusive ten-year warranty! We use the latest splining technology to produce splines that are stronger than traditional cut splines. The shafts are then precision CNC machined and magnaflux inspected for cracks before receiving a slick black anodized finish. Our front axle shaft kits include everything you need to complete the job: both passenger and drive side inner and outer axle shafts, seals, U-joints and clips.

JEEP® COMPLETE INNERS/OUTERS WITH U-JOINTS & CLIPS

| Application | Part # | Inner | Outer | Ring |
|---|--------|-------|-------|------|
| Jeep® Wrangler (JK) 07-12, Dana 30 27-Spline Kit NEW | 12152 | 27 | 32 | D30 |
| Jeep® Wrangler (JK) Rubicon 07-12, Dana 44 30-Spline Kit NEW | 12155 | 30 | 32 | D44 |

PERFORMANCE REAR AXLE KITS FOR JEEP®



High tensile strength 4140 Chromoly is heat-treated, tempered and induction hardened to produce these heavy-duty axles that are up to 35% stronger than stock 1040 axles. Alloy USA® uses the latest cold rolled splining technology, to produce splines that are stronger than traditional cut splines. Our shafts are covered by an exclusive 10-year warranty! Rear axle shaft kits include everything you need for your installation: both passenger and drive side shafts, seals, bearings and wheel studs. Upgraded spline counts for Jeep® applications: Dana 35 spline upgrades from 27 splines to 30 splines. Dana 44 spline upgrades from 30 splines to 33 and 35 splines.

Jeep® 2 Axles - Bearings - Seals - Wheel Studs

| | Part # | Spline | Ring |
|--|--------|--------|------|
| Jeep® Wrangler (JK) 07-12, Dana 44 Grande 30-Spline Kit NEW | 12156 | 30 | D44 |
| Jeep® Wrangler (JK) 07-12 Rubicon, Dana 44 Grande 32-Spline Kit NEW | 12158 | 32 | D44 |

PERFORMANCE REAR AXLE SHAFTS



Rule #1: If it broke it needed to be upgraded. For less than the cost of an original replacement axle shaft you can upgrade to an Alloy USA® performance shaft. Each axle is heat-treated, tempered and induction hardened to have twice the tensile strength than stock and is up to 35% stronger. We use the latest splining technology, to produce splines that are stronger than traditional cut splines.

Jeep® Axle Shafts, Sold Individually. Wheel Bearings, Seals, & Wheel Studs Available Separately

| | Part # | Hollander | Spline | Length | Side | Ring |
|---|--------|-----------|--------|---------|-------|------|
| Jeep® Wrangler (JK) 07-12, Dana 44, LH/RH, 30-Spline NEW | 21204C | NA | 30 | 31.49" | LH/RH | D44 |
| Jeep® Wrangler Rubicon (JK) 07-12, Dana 44, LH NEW | 21205C | NA | 32 | 30.79" | LH | D44 |
| Jeep® Wrangler Rubicon (JK) 07-12, Dana 44, RH NEW | 21206C | NA | 32 | 32.165" | RH | D44 |

All images are subject to be representative. More detailed information is available online.

JEEP® RING & PINIONS

These affordable high strength gear sets come in all the popular ratios to satisfy everyone's gearing needs. Oversized tires require higher ring & pinion ratios to restore performance. Made from high quality 8620 forgings and Gleason gear cutting technology, these gears are made to last. Complete installation kits are available separately to complete the job. Exclusive 5-year warranty. Available in 3.73, 4.10, 4.56, 4.88, 5.13 and 5.38 ratios.



NEW!



Ring & Pinions

| | Ratio | Part # |
|---|-------|-----------|
| FRONT | | |
| Wrangler (JK) 07-12, Front Dana 30, 3.73 Ratio NEW* | 3.73 | D30373RJK |
| Wrangler (JK) 07-12, Front Dana 30, 4.10, Ratio NEW* | 4.10 | D30410RJK |
| Wrangler (JK) 07-12, Front Dana 30, 4.88 Ratio NEW* | 4.88 | D30488RJK |
| Wrangler (JK) 07-12, Front Dana 30, 5.13 Ratio NEW* | 5.13 | D30513RJK |
| Wrangler (JK) 07 [w/ Trulok] 08-12 All, Front Dana 44, 4.10 Ratio NEW* | 4.10 | D44410RJK |
| Wrangler (JK) 07-12, Front Dana 44, 4.88 Ratio NEW* | 4.88 | D44488RJK |
| Wrangler (JK) 07-12, Front Dana 44, 5.13 Ratio NEW* | 5.13 | D44513RJK |
| Wrangler (JK) 07-12, Front Dana 44, 5.38 Ratio NEW* | 5.38 | D44538RJK |
| REAR | | |
| Wrangler (JK) 07-12, Rear 7/16 Bolts, Dana 44, 4.10 Ratio NEW* | 4.10 | D44410JK |
| Wrangler (JK) 07-12, Rear Dana 44, 4.88 Ratio NEW* | 4.88 | D44488JK |
| Wrangler (JK) 07-12, Rear Dana 44, 5.13 Ratio NEW* | 5.13 | D44513JK |
| Wrangler (JK) 07-12, Rear Dana 44, 5.38 Ratio NEW* | 5.38 | D44538JK |

*2012 and up models may require an aftermarket programmer to sync the new gear ratio to the transmission controller

WHEEL SPACERS



NEW!

Wheel Spacers

| Wheel Spacers | Width | Bolt Pattern | Part # |
|-------------------------------------|-------|--------------|--------|
| Jeep® Wrangler 2007-2012 NEW | 1.50" | 5 on 5.0" | 11300 |

ALLOY USA® FRONT AXLE X-JOINT COLD FORGED · SERVICEABLE

Front Axle X-Joint

| | Part # |
|--|--------|
| Heavy Duty Alloy X-joint, Complete U-joint With Bearings (760 Style) Replaces 5-297X/5-760X, 07-12 Wrangler Dana 30 NEW | 11500 |

Now a serviceable U-joint for Dana 44 applications is available to you. Replace your 760X U-joint with Alloy USA's new X-joint!

NEW!



OTHER U-JOINTS

Direct OE replacement



Other U-Joints

| Other U-Joints | Part # |
|--|----------|
| U-Joint, Dana 44 Front, Jeep® Wrangler (JK) Rubicon 07-12 NEW | 16525.08 |

NEW!

RING & PINION MASTER INSTALLATION & OVERHAUL KITS FOR JEEP®

These great kits offer all the components you will need to complete your differential rebuild or ring & pinion installation. Complete with bearings, pinion seals, pinion shims, crush sleeve, pinion nut, ring gear bolts and marking compound.



Ring & Pinion Master Installation & Overhaul Kits

| Ring & Pinion Master Installation & Overhaul Kits | Part # |
|--|--------|
| Wrangler (JK) 07-12, Dana 30, Front (NEW) | 352050 |
| Wrangler (JK) 07-12, Dana 44, Front (NEW) | 352051 |
| Wrangler Rubicon (JK) 07-12, Dana 44, Rear (NEW) | 352052 |
| Wrangler X, Sahara (JK) 07-12, Dana 44, Rear (NEW) | 352053 |

HD DIFFERENTIAL COVERS

Indestructible! You won't break these covers, we guarantee it. Made from either 3/8" cast steel or 5/16" stamped steel, painted black inside and out, these heavy-duty covers are designed to protect your differential and all its working parts for as long as you own your vehicle. These indestructible covers have been ".44 caliber tested" - if they can take a bullet at point blank range (don't try this at home!), they can take all that the trail has to offer. Available for most popular Dana differential types and include extra reinforcement protection for the fill plug area. All mounting hardware and instructions are included for ease of installation.

CAST



STAMPED



| Differential Cover | Cast 3/8" Steel | Stamped 5/16" Steel |
|--------------------|-----------------|---------------------|
| HD Dana 30 | 11206 | 11200 |
| HD Dana 44 | 11202 | - |
| HD Dana 60 | 11207 | 11203 |

ALLOY USA® AXLE TUBE SEALS

Keep water, mud and debris from entering your front axle housing. These CNC machined aluminum housings feature two seals to provide double protection from the crud.

Note: Must upgrade to 1 pc 30 spline grand axle. For use with all grande 30 spline axle upgrades & Rubicon Dana 44's.



Axle Tube Seals

| Axle Tube Seals | Part # |
|---|------------------------------|
| 07-12 Wrangler w/ Grande Axles (JK) Dana 30 or 44 front axle (2) NEW | 11105 (RED) 11106 (BLACK) |
| Replacement Inner Seal For 11105 and 11106 NEW | 11109 |



INTERIOR

| | |
|-------------------------------------|---------|
| FLOOR LINERS | C20 |
| GRAB HANDLES | C22 |
| HEAVY-DUTY | C45-C50 |
| OFF ROAD ACCESSORIES | |
| INTERIOR STORAGE/ ORGANIZERS | C24 |
| INTERIOR TRIM | C21 |
| REPLACEMENT INTERIOR ACCESSORIES | C22-C23 |
| SEATING | C37-C41 |
| SOUND ACCESSORIES | C19 |

PERFORMANCE

| | |
|-------------------|-----|
| AIR INTAKE KITS | C55 |
| CAT-BACK EXHAUST | C55 |
| DUAL BATTERY TRAY | C47 |
| EXHAUST HEADERS | C55 |

EXTERIOR

| | |
|--|------------------|
| BLACK EXTERIOR ACCESSORIES | C27-C28 |
| BODY ARMOR | C34 |
| BUMPER SYSTEMS | C2-C9 |
| COVERS | C15 |
| DOOR ACCESSORIES | C18-C19, C25 |
| EXTERIOR ENHANCEMENTS | C35 |
| FLARES & FENDERS | C10-C11 |
| HEADLIGHT TREATMENTS | C26, C31, C54 |
| OFF ROAD LIGHTING | C51-C54 |
| REPLACEMENT MIRRORS | C36 |
| SKID PLATES | C46 |
| STAINLESS/CHROME EXTERIOR ACCESSORIES | C29-C33 |
| STORAGE BOOT | C19 |
| TOPS/SUMMER BRIEFS/ ISLAND TOPPERS | C13-C18 |
| TUBE STEPS | C10 |
| WHEELS & WHEEL SPACERS | C12 |
| WINCHES & RECOVERY GEAR | C42-C44 |

SUSPENSION

| | |
|----------------------|---------|
| BRAKE HOSES | C63 |
| POLYURETHANE | C62-C63 |
| SUSPENSION KITS | C60-C61 |
| SHOCKS & STABILIZERS | C59 |

AXLE

| | |
|--|----------|
| FRONT AXLE KITS | C66 |
| LOCKERS | C71 |
| REAR AXLE KITS | C67 |
| RING & PINIONS | C68, C72 |
| WHEEL SPACERS, AXLE & DIFFERENTIAL COVERS | C68- C70 |

XHD MODULAR BUMPER SYSTEM

THE MOST ADVANCED, TOUGHEST, MOST FLEXIBLE BUMPER SYSTEM EVER CREATED!

No other bumper can give your Jeep® this many looks. Modular design provides dozens of different looks and styles. You can build the exact bumper of your choice! Custom designed for the 1976-2006 Jeep® Wrangler & CJ, each component maximizes the oversized look of the vehicle. All components are constructed of heavy-duty textured black powder coat steel with a tough E-Coat under-coating or polished, no rust, prime 304 stainless steel for the ultimate look! These tough finishes will provide years of heavy-duty use. Matching rear bumpers are available for a complete look.



CJ & Wrangler 76-06

XHD BUMPER SYSTEM

Front Bumpers

| | Part# |
|--|----------|
| Short Base, Winch Mount, Textured Black D-Rings, 76-06 CJ & Wrangler | 11540.40 |
| RRC Mount, 2.5" Tube, Textured Black for XHD Bumper, 76-06 CJ & Wrangler | 11540.48 |
| RRC Mount, 2.5" Tube, Textured Black for XHD Bumper, 76-06 CJ & Wrangler w/7" Flares | 11540.18 |
| Stinger Over-Rider, 2" Textured Black for XHD Bumper, 76-06 CJ & Wrangler | 11540.13 |
| Hoop Over-Rider, 60mm Textured Black for XHD Bumper, 76-06 CJ & Wrangler* | 11540.14 |
| Standard Ends, Textured Black for XHD Bumper, 76-06 CJ & Wrangler | 11540.42 |
| D-Rings, Pair For Use With Stinger & RRC D-Ring Mounts, 76-06 CJ & Wrangler | 11235.01 |
| Mounting Plates For Warn Power Plant Winch [for use on 11540.40 XHD Bumper only] | 11540.15 |

* Will not fit with power plant winch



| XHD Bumper System [Stainless Steel] | Part# | Part# |
|---|----------|------------------------------|
| Hoop Over-Rider, 60mm Stainless for XHD Bumper, 76-06 CJ & Wrangler* Each | 11540.16 | 11540.40, 11235.01, 11540.42 |
| Polished Stainless D-Rings, Replaces Standard XHD D-Rings, 76-06 CJ & Wrangler Pair | 11540.17 | |

* Will not work with Warn Power Plant Winch.

XHD STORAGE ENDS

11540.43
Storage Ends, Black



Looking for an easily accessible yet secure storage solution for your Wrangler? XHD Storage Ends from Rugged Ridge® turn your bumper into a stylish watertight storage vault. The XHD Storage ends are a great place to stow recovery gear and other valuables. Beefy steel construction, a watertight seal, and lockable lid helps keep mud and water out and your gear in.

| XHD Storage Ends | Part # |
|---|----------|
| Storage Ends, Textured Black, 76-86 CJ, 87-06 Wrangler NEW | 11540.43 |

IT'S OVER 100 BUMPERS IN ONE!

That's right, over 100 different bumpers! You won't find a more versatile bumper system. Go from hardcore to street savvy with just a few hand tools.



Standard Front Winch Mount With Stainless D-rings & Stainless Override Hoop: 11540.40, 11540.16, 11540.17, 11540.42



Standard Front Winch Mount: 11540.40, 11540.42

Online Build A Jeep® Application! www.ruggedridge.com



1. CHOOSE YOUR PAINT 2. PICK YOUR WHEELS 3. SET YOUR LIFT 4. DESIGN YOUR BUMPER





XHD REAR BUMPER

Make the most of your rear bumper with our XHD Rear Bumper System. Features easy installation, amazing looks and two reinforced heavy-duty D-Ring attachment points. Special "inner mounting plate" provides an extremely secure mounting point - strong enough for off-road use! The two-piece design allows use with and without tire carrier options. Heavy-duty powder coated steel design looks great but is extremely tough. Mount on the optional Tire Carrier and you can hold up to a 35" tire.



Internal inner structure provides strength and a durable location for the included D-Rings

The Massive Tapered Greasable Roller Bearing Hinge Supports Up To a 35" Tire.



Over Center Latching Mechanism Keeps Your Carrier Secure



D-rings attach securely to the frame of the vehicle for a rock solid recovery mounting point.

NEW!

TOW HITCH RECEIVER, FOR XHD REAR BUMPER



Tow Hitch Receiver, For XHD Rear Bumper

Part#

76-83 CJ5, 76-86 CJ7, 81-86 CJ8, 87-95 YJ, 97-06 TJ **NEW**

11580.03

Rear Bumpers

Rear XHD Bumper, Textured Black, Jeep® 76-83 CJ5, 76-86 CJ7, Wrangler [YJ] 87-95, [TJ] 97-06, Each **NEW**

11546.10

Tire Carrier Mount Add-on for 11546.10, Textured Black, Jeep® 76-83 CJ5, 76-86 CJ7, Wrangler [YJ] 87-95, [TJ] 97-06 **NEW**

11546.42

NEW!

TIRE CARRIER LINKAGE

Has opening your rear tailgate become a burden since you added a swing out tire carrier? Has it become easier to crawl over the rear seat to grab your gear, than hassling with the tire carrier? The Rugged Ridge® Tire Carrier Linkage Kit eliminates the issue and makes accessing the cargo area quick and painless. Once installed the linkage mates the tire carrier to the tailgate, so both open in a single fluid movement. The Tire Carrier Linkage is designed to work with Rugged Ridge® XHD, rear bumper and tire carriers, but will also work with most other aftermarket tire carriers. No drilling is required to mount the linkage to the tailgate, but some minor drilling is required to mount the linkage to the tire carrier.



Front Bumpers

Part#

Tire Carrier Linkage, 87-06 Wrangler **NEW**

11503.90

RRC ROCK CRAWLING BUMPERS

Introducing the toughest, most durable off-road tube bumpers ever made! The Rugged Ridge® Rock Crawling Bumpers (RRC) feature heavy-duty .120 wall 2" steel tubing treated with a special "E-Coating" and then dual stage powder-coated to ensure long life and a no-rust finish. These overbuilt tube bumpers not only look good but they are built to last! All RRC designs have been developed with true off-road enthusiasts in mind. From the reinforced welds to the built-in D-ring attachments, these bumpers and side guards are built to take what ever the trail throws at you.

RRC FRONT GRILLE GUARDS

The RRC Front Grille Guard is an easy to install front bumper system that offers an expanded opening for use with a winch (winch plate not included) or with up to four off-road lights. The RRC side supports elevate the tube upwards to provide fender protection while not altering the side clearance. Two reinforced D-ring attachments allow for easy use of optional D-rings (part no. 11235.01).



11502.12 RRC Front Grille Guard, Titanium



RRC Front Grille Guard

87-06 Wrangler Each *

* Including Wrangler Unlimited

Textured Black

11502.11

Titanium

11502.12

11502.11 RRC Front Grille Guard, Textured Black

RRC REAR BUMPERS

Rugged Ridge® offers two RRC bumper options for the rear of your Jeep®. Both options work off a similar frame mounted platform that features a heavy-duty grid like system with raised sides for the ultimate protection and greatest ground clearance. All RRC Rear Bumpers also feature a reinforced receiver hitch that is designed for off-road accessories (not designed or rated for towing. Use only for accessories). The heavy-duty rear tire carrier model mounts your tire off the rear bumper taking the load off your tailgate. With a reinforced grease fitting and special latching mechanism, this tire carrier is capable of holding up to a 35" tire.

11503.13 RRC Rear Bumper with Tire Carrier



11503.11 RRC Bumper with Hitch for 87-06 Wrangler

RRC Rear Bumper

87-06 Wrangler (1) RRC Rear Bumper w/Hitch
 87-06 Wrangler (1) (2) RRC Rear Bumper w/Tire Carrier
 (1) Including Wrangler Unlimited (2) Ships in 2 boxes

Textured Black

11503.11
 11503.13

CAUTION Receiver not designed or rated for towing. Use only for accessories (bike rack, etc.)

TIRE CARRIER RECOVERY (TCR) BAG

The TCR bag has been designed to mount to Rugged Ridge® RRC, XHD & Classic rear tire carrier bumpers. This bag allows the storage of all your recovery gear between the A-frame uprights on your rear tire carrier. Constructed of weather resistant material & features a zipper flap to help protect your gear from the environment. Attaches easily with 4 heavy-duty nylon straps that allow for quick removal and transport.



Carries Recovery Gear (not included)



Removable with Handy Carry Handle

Tire Carrier Recovery Bag (Each)

TCR Bag Fits RRC, XHD and Classic Rear Bumpers with Tire Carrier

Part #

12801.50



RRC SIDE ARMOR

Keep your rocker panels from being beaten to a pulp on the trail with Rugged Ridge®'s Side Armor. Built from heavy-duty 2" x 0.120" black texture powder coated steel tubing, these guards will take the beating that was meant for your sheet metal. YJ and TJ models require drilling. The black texture finish resists scratches and gives a slip-resistant surface for door entry. Sold as a pair and includes all necessary installation hardware.

11504.13 RRC Side Armor, Textured Black, 87-06 Wrangler



Frame mount design provides a no bounce fit

2"x12" Wall Construction, Black Texture Powder Coat Finish

11504.13 RRC Side Armor, Textured Black, 87-06 Wrangler with Hardware

Resists Scratches & Is Slip Resistant

RRC Side Armor

87-06 Wrangler Pair

Textured Black

11504.13

RRC ROCK SLIDERS

This true Rock Crawling design puts protection tight up under the side of your Jeep® while adding a special side "hoop" to block those large outcroppings. Special frame mounted design provides secure, bounce-free installation while keeping the mounting points above the bottom of the frame for greater ground clearance.

Frame Mounted Design Eliminates Bounce



11504.11 RRC Rock Slider, Textured Black, 87-06 Wrangler



RRC Rocker Guards

87-06 Wrangler Pair

Textured Black

11504.11

11504.11 RRC Rock Sliders, Textured Black, with Hardware, 87-06 Wrangler



All images are subject to be representative. More detailed information is available online.

FRONT TUBE BUMPERS FOR 1976-06 CJ, WRANGLER



Welded End Caps

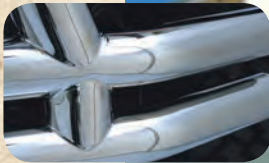

Polished Welds



CJ & Wrangler 76-06

| Front Bumpers | Front Bumper with Riser (Each) | Black | Textured Black | Titanium | Stainless |
|--|---|----------|----------------|----------|-----------|
| 76-06 CJ, Wrangler ** | Front Tube Bumper w/Riser | 11560.01 | 11561.01 | 11562.01 | 11563.01 |
| 76-06 CJ, Wrangler ** [1] | Front Bumper w/Winch Cutout | 11560.03 | 11561.03 | 11562.03 | 11563.03 |
| 76-06 CJ, Wrangler ** | Front Tube Bumper w/o Riser | 11560.02 | 11561.02 | - | - |
| For All Tube Bumpers | License Plate Mounting Bracket | 11503.80 | - | - | - |
| For All Tube Bumpers | Light Mounting Bracket | 11503.81 | - | - | - |
| For All Tube Bumpers | CB Antenna Mounting Bracket | 11503.88 | - | - | - |
| ** Including Wrangler Unlimited. [1] Winch mount plate not included. | | | | | |
| Raised Winch Mount Plate | Specially Designed for 87-06 Tube Front Bumpers NEW | 11238.12 | | | |
| Raised Winch Mount Plate | Specially designed for 76-86 CJ Tube front Bumpers NEW | 11238.13 | | | |

All Rugged Ridge® Front and Rear Bumpers feature smooth ground welds for an unbelievable look and further rust protection. No other tubular bumper manufacturer goes to the expense of smooth grinding their welds. This exclusive smooth grind process virtually eliminates small weld "pockets" that never seem to get full paint coverage and tend to rust over time. Finally, all Rugged Ridge® Bumpers feature welded end caps rather than plastic end caps. Gone are the days of constantly replacing those lost tube bumper end caps after a long day on the trail.



11560.02 Front Bumper without Riser, Black



Black

Textured Black

Stainless



11503.88 CB Antenna Mounting Bracket



11561.03 Front Tube Bumper with Winch Cutout, Black Textured

11503.80 License Plate Mounting Bracket



11503.81 Light Bracket

11560.03 Front Bumper with Winch Cutout, Black, 76-06 CJ & Wrangler



REAR TUBE BUMPERS FOR 1955-2006 JEEP®

Rear Bumpers have a larger 17" rear opening allowing the use of oversized tires (up to 31") on the factory spare tire mount. This is a Rugged Ridge® exclusive! Rugged Ridge® Rear Tube Bumpers also feature a frame mounted hitch option that allows for lightweight towing (2,000lb towing weight, 200lb tongue weight capacity). Most other rear tube bumpers with integrated hitch boxes do not recommend towing, therefore making the hitch box virtually useless. End caps are welded rather than using plastic end caps that fall out or melt.



11571.04 rear bumper with hitch, textured black, 87-06 Wrangler



Welded End Caps

Ground Welds



11572.04 Rear Bumper with Receiver Hitch, Titanium



11580.02 Rear Hitch with 2" Receiver



Black

Textured Black

Stainless



11570.01



11573.03



11573.04

Rear Bumpers

| | Black | Textured Black | Titanium | Stainless | |
|------------------------|--|----------------|----------|-----------|----------|
| 87-06 Wrangler [1] [2] | Rear Tube Bumper with Hitch | 11570.04 | 11571.04 | 11572.04 | 11573.04 |
| 87-06 Wrangler [1] | Rear Tube Bumper | 11570.03 | 11571.03 | 11572.03 | 11573.03 |
| 55-86 CJ [2] | Rear Tube Bumper with Hitch | 11570.02 | 11571.02 | - | - |
| 55-86 CJ | Rear Tube Bumper | 11570.01 | 11571.01 | - | - |
| Rear Hitch, CJ [3] | Fits Part #'s 11570.01, 11571.01 | 11580.01 | - | - | - |
| Rear Hitch, YJ, TJ [3] | Fits Part #'s 11570.03, 11571.03, 11572.03, 11573.03 | 11580.02 | - | - | - |

[1] also fits Wrangler unlimited [2] comes in 2 boxes [3] 2000 lb. towing weight, 200 lb. tongue weight. Will not fit YJ Renegade models.

All images are subject to be representative. More detailed information is available online.

HEAVY-DUTY ROCK CRAWLING BUMPERS



11545.01 Heavy-Duty Front Rock Crawling Bumper

The front bumper is a winch ready design that can accommodate any winch (winch mounting plate not included). E-Coat undercoating with a powder coat finish for the ultimate in rust protection and durability. Two welded D-ring tabs allow for easy installation of optional D-rings providing a secure pulling point. Sloped ends allow for greater off-road clearance and a great look. Rear Bumper has an accessory hitch box (not designed for towing) to mount optional accessories. This tough bumper set can take what the trail throws at you!

| Heavy-duty Rock Crawling Bumpers | Black |
|-------------------------------------|----------|
| 97-06 Wrangler/Unlimited Front Each | 11545.01 |
| 97-06 Wrangler/Unlimited Rear Each | 11546.01 |

CAUTION: Receiver not designed or rated for towing. Use only for accessories (bike rack, etc.).



11546.01 Heavy-Duty Off-Road Rear Bumper, Black

CJ & Wrangler 76-06

HEAVY-DUTY BUMPER W/FRONT ARMOR

Looking for that over-built extra tough look for your Jeep®? This exciting new winch ready bumper provides all you could want and more. Constructed of durable powder coat painted steel plate with rugged 2"x.120 wall tubing, this bumper has what it takes for rough and tumble off-road use. With a pre-cut front section and mounting points for a roller fairlead or Hawes fairlead, this bumper will accommodate most winches. Two welded D-ring tabs allow for easy installation of optional D-rings providing a secure pulling point. Trail tested, this is a great front bumper!

| Heavy-duty Bumper w/ Front Armor | Gloss Black |
|----------------------------------|-------------|
| 97-06 Wrangler/Unlimited, Each | 11540.01 |



11540.01 Heavy-Duty Bumper w/Front Armor

CLASSIC ROCK CRAWLING FRONT BUMPER



Looking for an economical yet tough bumper for those weekend adventures? The Classic Rock Crawling bumper series give you protection and understated good looks at an affordable price. All Classic Rock Crawler Bumpers are constructed of powder-coat painted steel with formed ends for greater ground clearance.

| Classic Rock Crawling Front Bumper | Textured Black |
|------------------------------------|----------------|
| 87-06 Wrangler/Unlimited, Each | 11502.20 |

CLASSIC ROCK CRAWLING REAR BUMPERS

Rugged Ridge® offers two Classic options for the rear of your Jeep®. Both options work off a similar frame mounted platform that features an over built steel design with raised sides for the ultimate protection and greatest ground clearance. All Classic Rear Bumpers also feature a reinforced hitch box that is designed for off-road accessories (not designed for towing). The heavy-duty rear tire carrier model mounts your tire off the rear bumper taking the load off your tailgate. With a reinforced grease fitting and special latching mechanism, this tire carrier is capable of holding up to a 35" oversized tire.



11503.21 Classic Rock Crawler Bumper with Rear Tire Carrier

| Classic Rock Crawling Rear Bumper | Textured Black |
|--|----------------|
| 87-06 Wrangler/Unlimited, Bumper Only, Each | 11503.20 |
| 87-06 Wrangler/Unlimited, Bumper w/Tire Carrier, Kit * | 11503.21 |
| TCR Bag Tire Carrier, Recovery Bag, Each | 12801.50 |

* Ships in two boxes

CAUTION: Receiver not designed or rated for towing. Use only for accessories (bike rack, etc.).

EURO STYLE BRUSH & GRILLE GUARDS

Designed to protect your vehicles front end from small tree limbs and brush, this stylish addition to your factory front bumper or upgraded Rugged Ridge® stainless front bumper will give you protection and style. The powder coated black Euro-Guard gives you that classic, black look.



11510.01 Euro Style Brush/Grille Guard

| Euro Style Brush & Grille Guard | Gloss Black |
|---------------------------------|-------------|
| 87-06 Wrangler, Each | 11510.01 |



11511.02 Front Bumper Guard without Brush Guard

FRONT BUMPER/BRUSH GUARDS

Add a bold rugged look to your vehicle with the Rugged Ridge® Front Bumper Guard. Designed to bolt onto your existing factory bumper, the Front Guard bolts on in minutes with no drilling necessary. Made of 3/8" steel side plates and 2.5" tubular cross members with a black powder coat for enhanced appearance and protection from the elements. Add-on extra protection with the optional bolt on Brush Guard [Note: The Rugged Ridge® Bumper Guard is required to install the Rugged Ridge® Brush Guard].



11511.02 Front Bumper Guard with 11512.02 Brush Guard

| Front Bumper and Brush Guards | Textured Black | Gloss Black |
|---|---|-------------|
| | 97-06 Wrangler (1) Front Bumper Guard [A] | 11511.01 |
| 87-95 Wrangler (2) Front Bumper Guard [A] | 11511.03 | - |
| 97-06 Wrangler (1) (3) Brush Guard [B] | 11512.01 | 11512.02 |
| 87-95 Wrangler Brush Guard [B] | 11512.03 | 11512.04 |

(1) including Wrangler Unlimited (2) fits 11512.03 & 11512.04 (3) fits 11511.01 & 11511.02

THE DEFENDER BUMPER

Big, burly and beautiful, this double tube front bumper gives you a look like no other. When that shiny over-built look is what you are going for, the Defender meets the criteria. Constructed of polished 304 stainless steel for rust free performance.



11521.01 defender bumper

| Front Defender Bumper | Stainless Steel |
|-------------------------------------|-----------------|
| 55-06 CJ / Wrangler/Unlimited, Each | 11521.01 |

FRAME COVERS



11120.03 Front Frame Cover



Rear Frame Cover

| Frame Covers | Stainless Steel |
|---------------------------------------|-----------------|
| 76-86 CJ, Front, Each | 11120.01 |
| 87-95 Wrangler, Front, Each | 11120.02 |
| 97-06 Wrangler/Unlimited, Front, Each | 11120.03 |
| 76-86 CJ, Rear, Each | 11120.04 |
| 97-06 Wrangler/Unlimited, Rear, Each | 11120.05 |

STAINLESS FRONT AND REAR BUMPER TREATMENTS

Want that classic look but with an extra "shine"? Rugged Ridge® prime 304 Stainless front and rear bumpers offer a beautiful alternative to the classic replacement bumper. Add the ultimate touch with a set of polished stainless Rocker Guards. Designed to match and complement all Rugged Ridge® polished stainless accessories, these bumpers will give your Jeep® that first class look while providing years of rust free service.



11107.05 Front Bumper without Holes, Stainless

Dress up the front of your vehicle with this simple to install bumper overlay. This overlay installs over your stock bumper to give a flashy look without the hassle of removing your bumper.

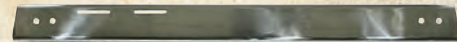

11109.02 Front Bumper Overlay, Stainless, 87-95 Wrangler



11107.06 Rear Bumper, Stainless

| Front & Rear Bumper Treatments, Stainless Steel | Part # |
|---|----------|
| 55-86 CJ Front Bumper with Holes, Each | 11107.01 |
| 87-95 Wrangler Front Bumper with Holes, Each | 11107.02 |
| 55-86 CJ Front Bumper without Holes, Each | 11107.03 |
| 87-95 Wrangler Front Bumper without Holes, Each | 11107.04 |
| 97-06 Wrangler (1) Front Bumper without Holes, Each | 11107.05 |
| 97-06 Wrangler (1) Rear Bumper without Holes, Each | 11107.06 |
| 87-95 Wrangler Front Bumper Overlay, Each | 11109.02 |
| 76-86 CJ Front Bumper Overlay, Each | 11109.01 |

(1) including Wrangler Unlimited

SIDE TUBE STEPS

Complete the look with a set of Rugged Ridge® tubular tough duty side steps. Rugged Ridge® Stainless Tube Steps feature prime 304L, .05" wall stainless tubing polished to a mirror finish. The polishing process for a Rugged Ridge® step is longer and deeper pulling out the deepest shine from the steel. A true "deep polish"! Rugged Ridge® painted steel Tube Steps feature special E-coated, .07" wall steel that is "thick source" powder coated for a tough chip resistant finish. The special E-coat undercoating provides double rust protection as it bonds to the metal creating a protective layer found nowhere else. All Rugged Ridge® Tube steps feature a truly custom fit with installation brackets constructed of durable 3/16" powder coated steel for long life and years of flex-free use. Each Tube Step features special UV treated no-slip step pads with 5 mounting pins. These step pads are preinstalled on top of the tube - no exposed metal to rust. 1976-06 models feature frame mount design which may require drilling.

76-06 models attach to the frame eliminating step bounce

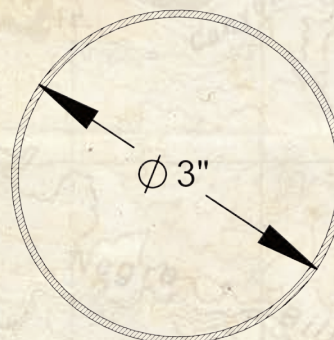

3 Inch Round Tube Step

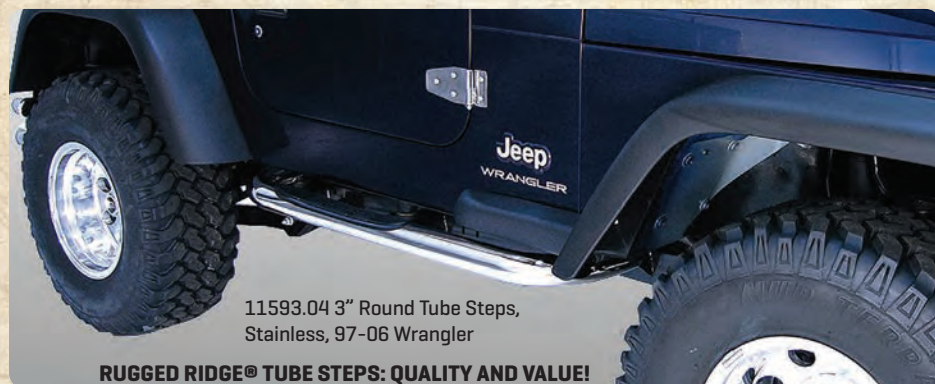
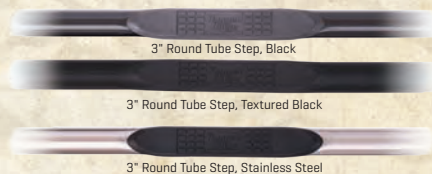

CJ & Wrangler 76-06

Side Tube Steps

| | Black | Textured Black | Titanium | Stainless |
|------------------------------|----------|----------------|----------|-----------|
| 97-06 Wrangler 3" Round Pair | 11590.04 | 11591.04 | 11592.04 | 11593.04 |
| 87-95 Wrangler 3" Round Pair | 11590.03 | 11591.03 | 11592.03 | 11593.03 |
| 76-86 CJ7 3" Round Pair | 11590.02 | 11591.02 | 11592.02 | 11593.02 |
| 76-83 CJ5 3" Round Pair | 11590.01 | - | - | - |

ALL TERRAIN FENDER FLARES

Get that aggressive off road look with the NEW Rugged Ridge® All Terrain Fender Flare! These 6" flares feature a stylish design while protecting your vehicles paint from flying rocks and mud. Constructed of durable UV treated ABS with a slight texture, these paintable flares provide a great look while being able to handle whatever nature throws at them. Each All Terrain Flare is designed to fit factory mounting points [CJ and YJ designs require some drilling] with durable rust proof stainless fasteners. Each front flare uses your existing side marker lights by easily attaching to custom light cut-outs. Backed by an industry leading 3 year limited warranty, these NEW All Terrain Flares will really set you apart from the crowd!



11630.10 for 1997-06 Wrangler/Unlimited

11632.10 for 1987-95 Wrangler

All Terrain Fender Flare Kits

| | Part # |
|---|----------|
| Fender Flare Kit w/ Hardware, 1997-2006 Wrangler/Wrangler Unlimited, 6 pc. Kit NEW | 11630.10 |
| Fender Flare Kit w/ Hardware, 1987-95 Wrangler*, 6 pc. Kit NEW | 11632.10 |
| Fender Flare Kit w/ Hardware, 1976-83 CJ5, 1976-86 CJ7, 1981-86 CJ8*, 6 pc. Kit | 11633.10 |

* Some drilling required

Need a little extra coverage for those over-sized tires? The Rugged Ridge® 7" Flare gives you the extra coverage you need while providing the clean look of original equipment designs. Each over sized flare is constructed of virtually indestructible UV treated thermoplastic to provide years of service. The special UV treatment put on each flare provides protection from sun fading. These flares are designed to bolt onto your vehicle but for CJ and 1987-95 Wrangler models, some vehicle modification may be necessary to truly cover those oversized tires. If you go off-road and need to protect your vehicle from rock chips and debris, look to Rugged Ridge® 7" oversized Fender Flares! Includes all mounting hardware.

OVERSIZED 7" FLARES



11608.01 Oversized 7" Flares, 97-06 Wrangler

11607.01 Oversized 7" Flares, 87-95 Wrangler

11606.01 Oversized 7" Flares, 76-86 CJ



Oversized 7" Fender Flares

| | Part # |
|--|----------|
| 76-86 CJ5, CJ7, CJ8, 4 Piece Kit w/all mounting hardware * | 11606.01 |
| 87-95 Wrangler, 6 Piece Kit w/all mounting hardware * | 11607.01 |
| 97-06 Wrangler, 6 Piece Kit w/all mounting hardware | 11608.01 |

* some trimming of the rear wheel well area is required to install oversized flares on CJ & YJ

REPLACEMENT FENDER FLARE KITS

Rugged Ridge® provides the most comprehensive replacement Fender Flare program on the market today. Covering model years starting in 1955 until current, Rugged Ridge® has you covered when it is time to replace or upgrade your Factory Fender Flares. Each Flare is constructed of virtually indestructible, durable, UV treated thermoplastic to provide years of service. Each replacement flare is designed to fit into your factory mounting holes (some models may require some hole relocation) for ease of installation. Just need to replace one flare? No problem. Rugged Ridge® offers individual replacements to keep your investment to a minimum.



11601.01 Replacement Fender Flares, 55-86 Jeep® CJ

11603.01 Replacement Fender Flare Kit, 97-06 Wrangler TJ

11601.01 Replacement Fender Flare Kit, 55-86 Jeep® CJ

11602.01 Replacement Fender Flare Kit, 87-95 Wrangler YJ



| Complete Kit | Part # | Front Passenger | | Front Driver | | Rear Passenger | | Rear Driver | |
|---------------------|-------------------------|-----------------|------|--------------|------|----------------|------|-------------|------|
| | | Part # | | Part # | | Part # | | Part # | |
| 97-06 Wrangler | 6-pc kit w hardware | 11603.01 | | | | | | | |
| | 4-pc kit w/out hardware | 11603.02 | Each | 11603.04 | Each | 11603.03 | Each | 11603.06 | Each |
| | 4-pc kit w/ hardware | 11603.12 | | | | | | | |
| 87-95 Wrangler** | 6-pc kit w hardware | 11602.01 | Each | 11602.04 | Each | 11602.03 | Each | 11602.06 | Each |
| | 4-pc kit w hardware | 11602.02 | | | | | | | |
| 55-86 CJ5/CJ7 | 4-pc kit w hardware | 11601.01 | Each | 11601.02 | Each | 11601.03 | Each | 11601.04 | Each |
| 81-86 CJ8 Scrambler | 4-pc kit w hardware | 11604.01 | Each | 11601.02 | Each | 11601.03 | Each | 11604.02 | Each |

*Except Sahara Models. **Does not fit YJ Renegade models.

11603.09 Hardware Kit



Replacement Fender Flare Hardware & Extensions

| Application | Item/Feature | Part # |
|----------------|--|----------|
| 87-95 Wrangler | Flare Extension, Driver Side Each | 11602.07 |
| 87-95 Wrangler | Flare Extension, Passenger Side Each | 11602.08 |
| 87-95 Wrangler | Extension retainer Each | 11602.09 |
| 55-86 CJ | Hardware Kit (Extension retainer not included) | 11601.06 |
| 97-06 Wrangler | Flare Extension, Driver Side Each | 11603.07 |
| 97-06 Wrangler | Flare Extension, Passenger Side Each | 11603.08 |
| 97-06 Wrangler | Hardware Kit | 11603.09 |



11602.09 Extension Retainer



11601.06 Hardware Kit



11602.07, 11602.08 Flare Extensions



11603.07, 11603.08 Flare Extensions



11602.05 Rear Flare, Driver Side, 87-95 Wrangler

All images are subject to be representative. More detailed information is available online.

STEEL D-WINDOW WHEELS

Legendary looks, brutally epic strength. Each Rugged Ridge® steel wheel is stamped from heavy gauge steel and powder coated with a durable black finish. Our wheels have been engineered, tested and certified to meet and exceed the strenuous SAE J2530 standards for wheel strength and durability. Turning a million cycles at double their load capacity to ensure they could hold up the abuses of off road use. Because a Jeep® isn't a Jeep® until its lifted and outfitted with oversized tires. Polished chrome enter cap included.



CJ & Wrangler 76-06

Description

| Description | Part # |
|---|----------|
| Steel wheel D-Window, Black, 15X8, 5 on 4.5 bolt pattern, 3.75 backspacing, Jeep® Wrangler [YJ] 87-95, [TJ] 97-06 NEW | 15500.01 |
| Steel wheel D-Window, Black, 15X10, 5 on 4.5 bolt pattern, 3.75 backspacing, Jeep® Wrangler [YJ] 87-95, [TJ] 97-06 NEW | 15500.02 |
| Steel wheel D-Window, Black, 15X8, 5 on 5.5 bolt pattern, 3.75 backspacing, Jeep® CJ 46-86 NEW | 15500.10 |

CENTER CAP FOR STEEL WHEELS

Polished Chrome Center caps in case you damage your originals. Mount directly to Rugged Ridge Steel D Window Wheels



Replacement Center Cap For Steel Wheels

| | Part # |
|---|----------|
| Chrome for Steel Wheels for 5 on 4.5 BP | 15201.52 |
| Chrome for Steel Wheels for 5 on 5.5 BP | 15201.53 |

WHEEL SPACER & ADAPTOR KITS

These hub centric spacers / adaptors move your wheels out to help fit wider tires and give your vehicle a wider track and improve stability. Constructed of double anodized black extra thick 6061T6 aluminum for long life and extra corrosion resistance. All hardware is grade-8 for extra strength. Each part number comes as a spacer pair. Included are 10 pre-installed grade-8 wheel studs, 10 lug nuts and thread locker.

Wheel Spacer Kit

| Wheel Spacer Kit | | Part # |
|---|----------------|----------|
| 87-06 Wrangler, Pair | 1.25" Spacer | 15201.02 |
| 45-86 CJ, Pair | 1.25" Spacer | 15201.03 |
| 87-06 Wrangler, Pair NEW | 1.5" Spacer | 15201.08 |
| 45-86 Wrangler, Pair NEW | 1.5" Spacer | 15201.09 |
| 87-06 Wrangler, Pair * | 1.25" Adapter | 15201.04 |
| 87-95 YJ Wrangler, 97-06 TJ Wrangler, 04-06 LJ Wrangler Unlimited* NEW | 1.375" Adapter | 15201.10 |

* converting 5 on 4.5" to 5 on 5.5" bolt pattern



15201.02 Wheel Spacer, pair, 1987-06 Wrangler with 5 on 4.5" Bolt Pattern



15201.03 Wheel Spacer, pair, 1946-86 Jeep® with 5 on 5.5" Bolt Pattern



15201.04 Wheel Adapter, pair, for Converting Bolt Pattern 5 on 4.5" to 5 on 5.5"

CAUTION!

CAUTION: Rugged Ridge® recommends use of wheel spacers with all suspension lifts to reduce risk of roll over or other accident associated with modifying ride height for increased off road capabilities. See additional product safety information and WARNINGS at back of catalog.

LOCKING HUBS

Rugged Ridge® Premium Hubs Feature:

- A full metal cap and body crafted from impact resistant nodular iron.
- Corrosion resistant die cast aluminum caps coated with high luster epoxy enamel for along lasting finish.
- Better 4WD performance when the manual hubs are locked. Works in reverse and compression braking.
- No slippage or partial engagement / disengagement issues that plague automatic hubs.
- Better fuel economy by freewheeling in 2WD mode. Great for any "tow vehicle".
- Decreases wear on internal components by engaging 4WD only when needed.
- More durable and cost effective than replacing or servicing automatic hubs.
- Ridiculously simple installation. Your average installation is completed in less than 20 minutes.
- Manual hubs offer extra gear ranges. By unlocking your hubs and driving in 4WD mode, you gain use of 2WD Low and 2WD High ranges.



| Make/Model | Years | Part # | Splines | |
|------------------------|-------|----------|---------|------------|
| | | | Count | Bolt Count |
| Jeep® | | | | |
| Willys CJ2A | 45-49 | 15001.01 | 10 | 6 |
| Willys CJ3A | 48-53 | 15001.01 | 10 | 6 |
| Willys CJ3B | 53-67 | 15001.01 | 10 | 6 |
| Willys M38A1 | 52-71 | 15001.01 | 10 | 6 |
| CJ5 & CJ6 | 55-71 | 15001.01 | 10 | 6 |
| CJ5, CJ6, CJ7 | 72-80 | 15001.02 | 27 | 6 |
| CJ7 & CJ8 | 81-86 | 15001.26 | 27 | 5 |
| Jeepster Commando C101 | 66-71 | 15001.01 | 10 | 6 |
| Jeepster Commando C104 | 72-73 | 15001.02 | 27 | 6 |
| Wagoneer & Gladiator | 63-73 | 15001.01 | 10 | 6 |



RUGGED RIDGE® SUMMER ACCESSORIES

Summer time is why you own a Jeep®! With the warm weather comes the open air driving we all love. Rugged Ridge® Summer Accessories make that open air driving more comfortable and stylish. Each accessory is manufactured to exacting specifications using tough matching vinyl coated fabrics that will provide years of great looks and high performance. When you demand the best, Rugged Ridge® is what you need!

SUMMER BRIEFS

Custom designed for each body style, these easy on, easy off briefs provide protection from the hot sun and sudden showers. Each Rugged Ridge® Summer Brief attaches to the factory center hoop and windshield with heavy-duty nylon straps to prevent flapping. Key rear strap attachments have quick release fasteners so once your straps are set, they easily detach and reattach. Wrangler models also incorporate thick hook and loop side mounts to further secure the top. All 1997-06 models are designed to be used with a no-drill Windshield Header (sold separately, see bottom of page) for quick conversion from hard top to Summer Brief.

| Summer Briefs | Black | Gray | Denim Black | Spice | Diamond Black | Diamond Khaki |
|---|----------|----------|-------------|----------|---------------|---------------|
| Header Summer Brief, 97-06 Wrangler*, Unlimited * | - | - | 13580.15 | 13580.37 | 13580.35 | 13580.36 |
| Summer Brief, 92-95 Wrangler ** | - | 13574.09 | 13574.15 | 13574.37 | - | - |
| Summer Brief, 87-91 Wrangler ** | 13573.01 | 13573.09 | 13573.15 | - | - | - |
| Summer Brief, 76-86 CJ7 ** | 13572.01 | - | - | - | - | - |
| Summer Brief, 76-83 CJ5 ** | 13571.01 | - | - | - | - | - |
| Summer Brief, 53-75 M38A1 & CJ5 | 13570.01 | - | - | - | - | - |

*Requires separate Windshield Header [#13308.04] for installation. ** Requires separate Windshield Channel [#13308.01] for installation.



POCKET BRIEFS

Tired of papers and other small items flying around the cab of your Jeep® when using your Summer Brief? Introducing the most innovative new addition to a Summer Brief in over 50 years the Pocket Brief from Rugged Ridge®! This revolutionary design incorporates two mesh zippered corner pockets directly over the driver and passenger creating much needed storage space. Special two sided mesh and nylon "pocket" seals shut with a reinforced zipper, keeps small items secure even in the most severe conditions. Built directly into the Rugged Ridge® Summer Brief to ensure a clean, tight fit. Constructed of durable soft top fabric for long life. Available in matching soft top colors to give your Jeep® a finished look.

| Pocket Brief | Gray | Denim Black | Spice | Diamond Black | Diamond Khaki |
|-----------------------------|----------|-------------|----------|---------------|---------------|
| 97-06 Wrangler, Unlimited * | - | 13585.15 | 13585.37 | 13585.35 | 13585.36 |
| 92-95 Wrangler ** | 13584.09 | 13584.15 | 13584.37 | - | - |
| 87-91 Wrangler ** | - | 918315 | - | - | - |

* Requires a separate Windshield Header [#13308.04] for installation ** Requires a separate Windshield Channel [#13308.01] for installation See information on Page 18.

WARNING: Warning: Tops and doors are designed only for protection against the elements. Do not rely on top or doors to contain occupants within the vehicle or protect against injury during an accident. Consult vendor's product safety literature for additional information and WEAR SEAT BELTS AT ALL TIMES.

WINDSHIELD CHANNELS/HEADERS

These upgraded preassembled windshield headers installs quickly and easily! Just attach your Brief/Island Topper and place the header channel on the top of your windshield, slide the clamps onto the supplied knobs and clamp the channel in place. That's it! The channel is now securely held in place and ready for summer wheeling. No drilling or modifications required! Note: Will work with Bestop and other aftermarket summer tops. No Drill Windshield Header required for installation of Summer Briefs and Island Toppers on all 1997-06 Wranglers and Unlimited. Windshield Channels are required for installation of Summer Briefs and Island Toppers on all 1976-95 CJ/Wranglers.

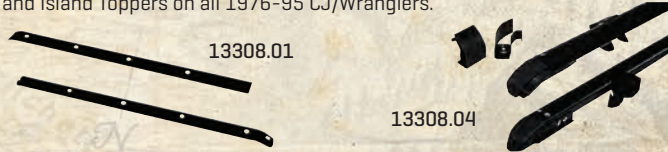

| Description | Part # |
|--|----------|
| Windshield Header, 97-06 Wrangler (no drill), Each | 13308.04 |
| Windshield Channel, 76-95 Jeep® CJ and Wrangler, Each | 13308.01 |
| Windshield Channel, 98-02 Wrangler (drilling required), Each | 13308.02 |

TIRE COVERS



Custom designed to fit today's most popular sized tires. Constructed of durable vinyl coated polyester fabric. Colors match other Rugged Ridge® Soft Accessories. Please measure tire diameter.



| Tire Diameter | Black | Gray | Denim Black | Spice | Diamond Black | Diamond Khaki |
|---------------|----------|----------|-------------|----------|---------------|---------------|
| 27-29" | 12801.01 | 12801.09 | 12801.15 | 12801.37 | 12801.35 | 12801.36 |
| 30-32" | 12802.01 | 12802.09 | 12802.15 | 12802.37 | 12802.35 | 12802.36 |
| 33" | - | 12803.09 | 12803.15 | - | 12803.35 | - |
| 35-36" | - | 12804.09 | 12804.15 | - | 12804.35 | - |

Note: To ensure proper fit, measure the diameter of the tire you are covering and pick the appropriate tire cover size listed above.

All images are subject to be representative. More detailed information is available online.

MESH SUMMER BRIEFS/ISLAND TOPPERS™

Special UV treated mesh fabric blocks the heat while allowing the cool breeze to flow through. The special weave of the Rugged Ridge® mesh brief/Island Topper is designed for strength and durability while providing open air protection from the sun's heat. Available in two great styles: the Summer Brief that goes to the center hoop and the "Island Topper" that goes back to cover those rear seat passengers. Don't forget the Header/Windshield channel needed to install these tops!



Mesh Summer Brief



Mesh Summer Briefs Include Corner Pockets

Mesh "Island Topper"



Description

- Mesh Summer Brief, 97-06 Wrangler, Unlimited, Each *
- Mesh Island Topper, 97-06 Wrangler, Each *
- Mesh Summer Brief, 92-95 Wrangler, Each **
- Mesh Island Topper, 92-95 Wrangler, Each **
- * Requires a separate Windshield Header [#13308.04] for installation
- ** Requires a separate Windshield Channel [#13308.01] for installation

Part #

- 13576.01
- 13578.01
- 13575.01
- 13577.01

CJ & Wrangler 76-06

ACOUSTIC BRIEF AND ISLAND TOPPER™

This unique design drastically reduces road noise within the cab of your Jeep®. We have lined each acoustic piece with a tightly woven, padded acoustic insert that absorbs outdoor noise to allow for a pleasant driving experience. You can finally listen to your favorite radio or CD while you enjoy open air driving! Durable quick release buckles for easy on - easy off installation. Acoustic Brief provides overhead protection for both front seat passengers. Acoustic Island Topper provides overhead protection for both front & rear passengers.



Padded insert absorbs noise allowing for a more pleasant driving experience

Acoustic Island Topper, Header Mount, Black Denim

| Part # | |
|------------------------|----------|
| 97-06 Wrangler, Each * | 13582.15 |

Acoustic Brief, Header Mount, Black Denim

| | |
|----------------------------------|----------|
| 97-06 Wrangler/Unlimited, Each * | 13583.15 |
|----------------------------------|----------|

* Requires a separate Windshield Header [#13308.04] for installation

ROLL BAR CURTAIN

Provides protection from dust, rain and other debris entering the cab of your Jeep® and also keeps heat in during the cold winter months. Easily attaches to the sport bar with durable nylon straps. Constructed of durable soft top fabric that matches other Rugged Ridge® Accessories. Special rear opening allows for easy access to cargo area: zips open and closed. DOT approved rear glass allows for rear visibility.



Roll Bar Curtain

| | Gray | Denim Black | Spice | Diamond Black | Diamond Khaki |
|--------------------------------|----------|-------------|----------|---------------|---------------|
| 80-06 CJ, Wrangler & Unlimited | 13552.09 | 13552.15 | 13552.37 | 13552.35 | 13552.36 |

ROLL BAR COVER KITS

Custom covers dress up your vehicle's roll bar with light weight foam and summer soft goods fabric. Roll Bar Covers easily install using zippers and "hook & loop" attachments. Special cut outs for seat belt locations make the covers look clean. Multiple piece design available for 1992-02 Wrangler models with over the door cross members.

Roll Bar Cover Kits

| Part # | |
|---|----------|
| 97-02 Wrangler, Denim Black, 3 pc. Kit | 13612.15 |
| 92-95 Wrangler, Denim Black, 3 pc. Kit | 13611.15 |
| 78-91 CJ & Wrangler, Denim Black, 1 pc. Main Hoop Cover * | 13610.15 |
| 78-91 CJ & Wrangler, Black, 1 pc. Main Hoop Cover * | 13610.01 |

* 87-91 Wrangler, does not include over door spreader covers



WARNING: Warning: Tops and doors are designed only for protection against the elements. Do not rely on top or doors to contain occupants within the vehicle or protect against injury during an accident. Consult vendor's product safety literature for additional information and WEAR SEAT BELTS AT ALL TIMES.

ISLAND TOPPERS™

Provide the ultimate summer sun and rain protection with a Rugged Ridge® Island Topper. Attaching the same way as our durable Summer Briefs, these full length tops provide protection from the elements for both the front and rear passengers. Rear attachment straps secure to the rear sport bar hoops on 1992-06 models. 1976-91 models include an easy to attach rear bow. All 1997-06 models are designed to be used with an optional, no-drill Windshield Header for quick conversion from hard top to Summer Brief.



13581.36 Roll Bar Top, Diamond Khaki, 97-06 Wrangler



13581.35 Island Topper, Diamond Black, 97-06 Wrangler

| Description | Gray | Denim Black | Spice | Diamond Black | Diamond Khaki |
|---------------------------------------|----------|-------------|----------|---------------|---------------|
| Header Island Topper, 97-06 Wrangler* | - | 13581.15 | 13581.37 | 13581.35 | 13581.36 |
| Island Topper, 92-95 Wrangler** | 13553.09 | 13553.15 | 13553.37 | - | - |
| Island Topper, 76-91 CJ & Wrangler** | 13554.09 | 13554.15 | - | - | - |

* Requires a separate Windshield Header (#13308.04) for installation ** Requires a separate Windshield Channel (#13308.01) for installation



*Representative image of Island Topper, Diamond Black



Pocket Island Toppers feature zippered pockets to securely stow away important items like cell phones, maps and sunglasses.

POCKET ISLAND TOPPERS™

The most advanced summer soft top solution found on the market today, the new Pocket Island Topper! This new design features tough diamond fabric combined with a pair of zipper front pockets for the ultimate full featured top. Unlike other summer tops on the market, the Rugged Ridge® design features wider side hook and loop fastener straps, a reinforced front section and extra heavy duty nylon tie down straps.

Pocket Island Toppers

| | Diamond Black | Diamond Khaki |
|-----------------|---------------|---------------|
| 97-06 Wrangler* | 13586.35 | 13586.36 |

* Requires a separate Windshield Header (#13308.04) for installation

WATER RESISTANT CAB/FULL COVERS

Custom fit Cab Covers protect your vehicles interior from dust, dirt and light showers. Constructed of vinyl coated polyester fabric or a space age cover material [Weather Lite/Three Layer Covers], these easy to use covers install in minutes. Reinforced elastic side straps and under body hooks hold the cab cover in place. No drilling required. Complete vehicle covers also available in breathable Weather Lite fabric or durable Three Layer Fabric. Weather Lite is perfect for inside storage while the Three Layer covers are designed for short term outdoor use.



Full Covers

| | Part # |
|---|----------|
| Three Layer Full Car Cover (w/Bag & Lock), 04-06 Wrangler Unlimited | 13321.73 |
| Three Layer Full Car Cover (Cover only), 04-06 Wrangler Unlimited | 13321.71 |
| Three Layer Full Car Cover, 55-06 CJ/Wrangler * | 13321.70 |
| Three Layer Full Car Cover (w/Bag & Lock), 55-06 CJ & Wrangler | 13321.72 |
| Weather Lite Full Cover, All CJ7 & Wrangler * | 13321.51 |
| Car Cover Storage Bag | 12105.01 |

*Will not fit 04-06 Unlimited



Complete Cover kits with lock and storage bag available.

3 LAYER PROTECTION!

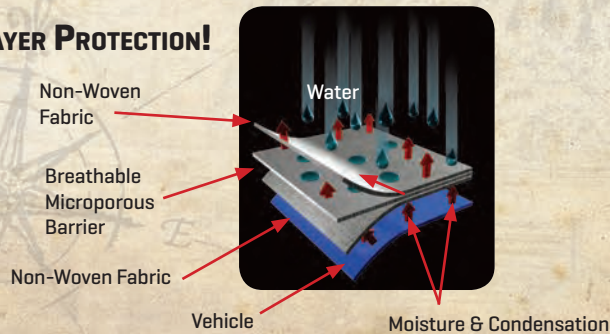

Cab Covers

| | Part # |
|--|----------|
| Water Resistant Vinyl Cab Cover, 92-06 Wrangler, Spice * | 13316.37 |
| Water Resistant Vinyl Cab Cover, 92-06 Wrangler, Gray * | 13316.09 |
| Water Resistant Vinyl Cab Cover, 87-91 Wrangler, Gray | 13310.09 |
| Water Resistant Vinyl Cab Cover, 76-86 CJ7, Gray | 13315.09 |
| Three Layer Cab Cover, 76-06 CJ & Wrangler * | 13321.02 |
| Weather Lite Cab Cover, 76-06 CJ & Wrangler * | 13321.01 |

* Will not fit 04-06 Unlimited

All images are subject to be representative. More detailed information is available online.

QUALITY, VALUE, SELECTION, XHD REPLACEMENT TOPS HAVE YOU COVERED!

New and improved XHD Replacement Soft-Tops from Rugged Ridge® are now available with 50% thicker glass! Each Fabric Soft Top is specifically designed to easily fit the factory original soft top hardware. Simply take off the old top and slip on the new. It's just that easy! These new designs feature reinforced stitching on the heavy "pull" areas as well as heavy duty 30 mil thick glass! All XHD Soft Tops feature durable vinyl coated polyester and cotton fabric that will last the test of time. All sewn seams use marine grade thread to make sure it does not deteriorate or discolor in the sun. Each seam is literally "welded shut" with durable heat seal tape to keep moisture out while keeping the original look of the top intact. Attaching the Rugged Ridge® Top is easy with the factory original "belt rail" attachment method; simply tuck under the rail and go! All our tops feature two choices of door options as Jeep® offered the 97-06 Wrangler with upper soft doors or with full hard doors. Rugged Ridge® makes a Replacement Top that fits either! Each top is backed by an industry leading 3 year limited warranty against manufacturer defects.

The most comprehensive line of replacement soft tops on the market, so you can choose what options are best for you!



NEW 30 mil thick DOT approved windows are 50% thicker than lower cost soft tops! Available in clear or 31% tint (rear quarter and rear glass) on most Jeep® models.



Jeep® applications (and late model Suzuki) feature zip out windows for the true open air experience. Each side and rear window have durable zipper attachments covered by weather seals to keep the weather out



Rugged Ridge® soft tops use only the finest vinyl coated polyester fabric or durable sail cloth on all their tops. Each fabric color is specially formulated to match the original equipment colored top to make your Jeep® look like it came off the show room floor.

NEW!



BLACK/SAILCLOTH



CHARCOAL



DARK TAN



DIAMOND BLACK



BLACK DENIM



SPICE



DIAMOND KHAKI

XHD SOFT TOP APPLICATIONS

| Fabric Replacement Tops for 88-95 Jeep® Wrangler | Diamond Black | Charcoal | Black Denim | Spice |
|--|---------------|---------------|-------------|----------|
| W/Door Skins | - | 13721.09 | 13721.15 | 13721.37 |
| W/Door Skins, Tinted Windows | - | 13722.09 | 13722.15 | 13722.37 |
| Fabric Replacement Tops for 97-02 Jeep® Wrangler | Diamond Black | Black Denim | Dark Tan | Spice |
| W/Door Skins | - | 13723.15 | 13723.33 | 13723.37 |
| W/Door Skins, Tinted Windows | - | 13724.15 | 13724.33 | 13724.37 |
| No Door Skins | - | 13725.15 | 13725.33 | 13725.37 |
| No Door Skins, Tinted Windows | - | 13726.15 | 13726.33 | 13726.37 |
| W/Door Skins, Tinted Windows NEW | 13724.35 | - | - | - |
| Fabric Replacement Tops for 03-06 Jeep® Wrangler | Diamond Black | Diamond Khaki | | |
| W/Door Skins | 13727.35 | - | 13727.36 | - |
| W/Door Skins, Tinted Rear Windows | 13728.35 | - | 13728.36 | - |
| No Door Skins | 13729.35 | - | 13729.36 | - |
| No Door Skins, Tinted Rear Windows | 13730.35 | - | 13730.36 | - |
| Without Door Skins, Jeep Wrangler Unlimited (LJ) 04-06 NEW | 13731.35 | - | - | - |
| Sailcloth Fabric Replacement Tops | Sailcloth | | | |
| XHD Replacement Soft Top W/Door Skins, Tinted Windows, Sail Cloth, 30 Mil Glass, Jeep Wrangler (TJ) 1997-2006 NEW | 13728.01 | - | - | - |

REPLACEMENT DOOR SKINS

NEW Door Skins now available to replace your factory soft upper door fabric & glass. These door skins come in pairs and fit over your factory door frames with durable hook and loop fasteners. Simply cut off the old and slip on the new! Each door skin feature double zippers and heavy duty bulb seals for ease of use and a weather tight fit. Crystal clear 30 mil DOT approved door window glass will last the test of time.

COMING SOON



COMPLETE SOFT UPPER DOORS

Replace both your door frames and door skins all at once! Each kit includes two steel door frames and a set of door skins listed above. Perfect for those older Wranglers that have damaged doors

| Door Skins | Charcoal | Black Denim | Diamond Black | Spice | Dark Tan | Diamond Khaki |
|---------------------------|----------|-------------|---------------|----------|----------|---------------|
| 88-95 Wrangler NEW | 13716.09 | 13716.15 | 13716.35 | 13716.37 | - | - |
| 97-06 Wrangler NEW | - | 13717.15 | 13717.35 | 13717.37 | 13717.33 | 13717.36 |
| Upper Doors | Charcoal | Black Denim | Diamond Black | Spice | Dark Tan | Diamond Khaki |
| 88-95 Wrangler NEW | 13713.09 | 13713.15 | 13713.35 | 13713.37 | - | - |
| 97-06 Wrangler NEW | - | 13714.15 | 13714.35 | 13714.37 | 13714.33 | 13714.36 |

WARNING:

Warning: Tops and doors are designed only for protection against the elements. Do not rely on top or doors to contain occupants within the vehicle or protect against injury during an accident. Consult vendor's product safety literature for additional information and WEAR SEAT BELTS AT ALL TIMES.

BOWLESS TOP FOR 97-06 WRANGLER

The Bowless Top from Rugged Ridge® is the most versatile Jeep® soft top on the market. It allows you to convert instantly from a full top to a summer brief, and eliminates the need for the bulky OE soft top frame. The Bowless Top fits snugly over the factory roll bar for a more aerodynamic “fastback” look, but retains your factory door surrounds and tailgate bar to provide an air tight fit. Convert to a summer brief by simply unzipping the side windows and stowing them in the rear window storage fold designed into the top. The Bowless top is made to the same specifications as our factory replacement tops and features: reinforced stitching on the heavy “pull” areas, as well as heavy duty 30 mil thick DOT approved 31% tint window glass, durable vinyl coated polyester and cotton fabric, and all sewn seams use marine grade thread to make sure it does not deteriorate or discolor in the sun.



CJ & Wrangler 76-06



Windows fold up under top for open air driving.

Top includes 2 zippered storage pockets.

More Exclusive Features:



BLACK DENIM



SPICE



Sail Cloth

- NEW design is less complex and easier to install than competitive brand tops.
- Custom design fits better using significantly fewer straps and no center bow. Our bowless top uses only two Velcro side straps, one center adjusting strap and two rear straps making a better fitting, easier to install top
- All straps are inside the top making for a cleaner better looking design
- Rear window either rolls up or can be used as the storage flap for side windows. No extra pockets or complicated securing device to store your rear quarter windows
- Side weather protecting foam is attached to the top. Competitive brands have this foam separate from the top creating a potential missing part
- Each Top includes a pair of handy zippered side pocket for map and accessory storage
- Side design includes a handy installation pull tab for ease of installation
- Notorious leak spots behind the doors have been covered with a special rain flap; keeps the weather out!
- Backed by our industry leading three year limited warranty. Most soft top warranties are only 1-2 years!

Bowless Tops

| | Part# |
|---|----------|
| Bowless Soft Top, Black Diamond, 97-06 Wrangler, for use with OE door surrounds. * NEW | 13750.35 |
| Bowless Soft Top, Denim Spice, 97-06 Wrangler, for use with OE door surrounds.* NEW | 13750.37 |
| Bowless Soft Top, Black Sail Cloth, 97-06 Wrangler, for use with OE door surrounds.* NEW | 13750.01 |
| Bowless Soft Top, Black Diamond, 97-06 Wrangler, includes replacement door surrounds. NEW | 13751.35 |
| Bowless Soft Top, Denim Spice, 97-06 Wrangler, includes replacement door surrounds. NEW | 13751.37 |
| Bowless Soft Top, Black Sail Cloth, 97-06 Wrangler, includes replacement door surrounds. NEW | 13751.01 |

* Hard top models will need factory door surrounds to install this top.

Note: Requires a separate windshield header (Omix PN: 13308.04) and your factory tailgate bar for installation. (Replacement tailgate bar available - Omix PN: 13550.01)



WARNING:

Warning: Tops and doors are designed only for protection against the elements. Do not rely on top or doors to contain occupants within the vehicle or protect against injury during an accident. Consult vendor's product safety literature for additional information and WEAR SEAT BELTS AT ALL TIMES.

All images are subject to be representative. More detailed information is available online.

Soft Top Hardware

REPLACEMENT TOP HARDWARE FOR 87-95 YJ

Includes all the necessary components to completely replace/upgrade your factory original soft top hardware. Our exclusive OE quality tailgate bar provides an upgraded tailgate seal and easy installation. Adjustable Side Spreader Bars have been upgraded to ensure a long life. Combine with a fabric only XHD replacement top [see page 16] for an inexpensive complete soft top.



| Replacement Hardware | Part # |
|------------------------|----------|
| 87-95 YJ Wrangler, Kit | 13510.01 |

REPLACEMENT SPREADER BARS FOR 87-95 YJ

Upgrade or replace those worn original equipment YJ Spreader Bars. Deluxe Spreader Bars are upgrades from original and are sold individually. Ultimate Spreader Bars, sold in pairs, incorporate a twist soft top tightening feature that can tighten your soft top during warm weather.



Deluxe Spreader Bar

| Replacement Spreader Bars | Part # |
|--|----------|
| Deluxe Spreader Bar, 87-95 YJ Wrangler, Each | 11251.01 |
| Ultimate Adjustable Spreader Bars, 87-95 YJ Wrangler, Pair | 11251.02 |

SOFT TOP WINDSHIELD RETAINER FOR 87-95 YJ

Replaces factory plastic retainers that are mounted vertically on the left and right side of the YJ windshield frame inside the vehicle. Available in pairs or individually.



| Description | Part # |
|------------------------------------|----------|
| 87-95 Wrangler, Drivers Side, Each | 12306.03 |
| 87-95 Wrangler, Pass. Side, Each | 12306.04 |
| 87-95 Wrangler, Pair | 12306.05 |

SOFT TOP DISCONNECTS

Upgrade your factory 1997-06 Wrangler Soft Top Hardware with these quick release bow mounts. Allows for easy, no tool disconnect of your soft top bows from your Jeep®. Installation is easy and quick, no drilling required.

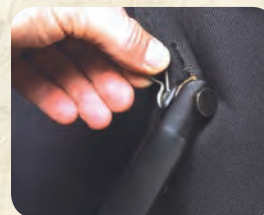

| Soft Top Disconnect Kit | Part # | |
|-------------------------|----------|---|
| 97-06 Wrangler, 4 pack | 11251.03 | 11251.03 Soft Top Disconnect for 97-06 Wrangler |

REPLACEMENT TAILGATE BAR WITH TONNEAU COVER

Upgrade your rear tailgate bar with this high quality Tonneau/Tailgate Bar from Rugged Ridge®. A special tailgate seal provides the ultimate attachment for your rear soft top window to the tailgate bar. As an added feature, a special channel has been added to attach the enclosed behind the seat tonneau cover to keep valuables out of sight.



Tailgate Bar/Tonneau

| Replacement Tailgate Bar w/Black Denim Tonneau | Part # |
|--|----------|
| 87-06 Wrangler, Each | 13550.01 |

REPLACEMENT SOFT TOP UPPER DOOR FRAMES

Until now, these door frames have been very hard to find. Leave it to Rugged Ridge® to solve yet another problem! Upper door steel frame for factory soft top Jeep® models. Update your top by replacing those worn out doors! Simply slip on your replacement door skins [sold separately as a part of our XHD Soft Top Kits] and you have up-graded that old top. Each frame is designed to fit factory soft top applications only. Sold as a pair. Rugged Ridge® skins not available for CJ7.



13701.80 Door Frame, 87-95 Wrangler

13703.80 Door Frame, 97-06 Wrangler

13715.80 Door Frame, 76-86 CJ7

| Soft Top Door Frames | Part # |
|--|----------|
| 97-06 Wrangler, Pair * | 13703.80 |
| 87-95 Wrangler, Pair * | 13701.80 |
| 76-86 CJ7, 81-86 CJ8, Pair ** NEW | 13715.80 |

* Will only fit original style factory soft upper door skins
 ** Will only fit original style factory door skins

REPLACEMENT DOOR SKINS

NEW Door Skins now available to replace your factory soft upper door fabric & glass. These door skins come in pairs and fit over your factory door frames with durable hook and loop fasteners. Simply cut off the old and slip on the new! Each door skin feature double zippers and heavy duty bulb seals for ease of use and a weather tight fit. Crystal clear 30 mil DOT approved door window glass will last the test of time.



COMPLETE SOFT UPPER DOORS

Replace both your door frames and door skins all at once! Each kit includes two steel door frames and a set of door skins listed above. Perfect for those older Wranglers that have damaged doors

| Door Skins | Color | | | | | | |
|---------------------------|----------|-------------|---------------|----------|----------|---------------|--|
| | Gray | Black Denim | Diamond Black | Spice | Dark Tan | Diamond Khaki | |
| 88-95 Wrangler NEW | 13716.09 | 13716.15 | 13716.35 | 13716.37 | - | - | |
| 97-06 Wrangler NEW | - | 13717.15 | 13717.35 | 13717.37 | 13717.33 | 13717.36 | |

| Upper Doors | Color | | | | | | |
|---------------------------|----------|-------------|---------------|----------|----------|---------------|--|
| | Gray | Black Denim | Diamond Black | Spice | Dark Tan | Diamond Khaki | |
| 88-95 Wrangler NEW | 13713.09 | 13713.15 | 13713.35 | 13713.37 | - | - | |
| 97-06 Wrangler NEW | - | 13714.15 | 13714.35 | 13714.37 | 13714.33 | 13714.36 | |



WARNING: Warning: Tops and doors are designed only for protection against the elements. Do not rely on top or doors to contain occupants within the vehicle or protect against injury during an accident. Consult vendor's product safety literature for additional information and WEAR SEAT BELTS AT ALL TIMES.

12106.01
Soft Top Storage Bag



12107.01
Window Storage Bag



SOFT TOP AND WINDOW STORAGE SOLUTIONS

Prolong the life of your soft top or windows with this handy storage bag from Rugged Ridge®. Features special soft sided fabrics that "cradle" your soft top or windows. Both solutions use oversized zippers and durable nylon fabrics for long life and weather resistance. Special handle placement allows for easy carrying and storage.

Storage Bags, Black

| | Part # |
|---|----------|
| Soft Top Storage Bag, Each | 12106.01 |
| Window Storage Bag, Each (holds 2 rear quarter windows) | 12107.01 |

HARD DOOR STORAGE BAGS



12108.01 Hard Door Storage Bag

Prolong the life of your hard doors with this handy storage option from Rugged Ridge®. Each storage bag features special soft sided fabric that "cradles" your hard door. We use oversized zippers and durable nylon fabrics for long life and weather resistance. Special handle placement allows for easy carrying and storage.

Storage Bags

| | Part # |
|-------------------------------------|----------|
| Hard Door Storage bags, Pair, Black | 12108.01 |

SOFT TOP STORAGE BOOT



Protect your soft top when it is folded down. Keeps soft top close by in case of sudden showers. Designed to be used with the windows zipped out.

Soft Top Storage Boot

| | Part # |
|--------------------------------------|----------|
| 97-06 Wrangler, Black Denim, Each* | 12104.15 |
| 97-06 Wrangler, Spice, Each* | 12104.37 |
| 46-95 CJ/Wrangler, Black Denim, Each | 12105.15 |
| 46-95 CJ/Wrangler, Spice, Each | 12105.37 |

* Will not fit Wrangler Unlimited



NEW!



CB RADIO DASH MOUNT

This easy no drill mounting bracket makes it a snap to install a CB in your TJ. Just remove two dash screws and replace them with the longer screws provided in the kit. Once that is done just install the CB and fuel up for your next trail ride!

CB Radio Dash Mount

| | Part # |
|---------------------------|----------|
| 97-06 Wrangler NEW | 13551.09 |



SOUND BOXES

- Tough Roto-molded plastic design protects from harsh weather
- Two speaker design; two way bottom speaker with a high frequency tweeter mounted on top for a great sound
- Available with or without speakers in two interior matching colors
- Packed in pairs with mounting hardware and all needed wiring



13003.01 Sound Boxes without Speakers



13004.37 Sound Boxes with Speaker



13004.01 Sound Box with Speaker

Sound Boxes

| | Black | Spice |
|-----------------------------------|----------|----------|
| 97-06 Wrangler w/ Speakers, Pair | 13004.01 | 13004.37 |
| 97-06 Wrangler w/o Speakers, Pair | 13003.01 | 13003.37 |

All images are subject to be representative. More detailed information is available online.

RUGGED RIDGE® ALL TERRAIN FLOOR LINERS FOR 1976-06 CJ & WRANGLER



The only floor liner with patent pending "Deep Tread" Technology!

These floor liners are a totally new concept that combines all the best features of a deep rib floor mat and the 'old style' liners. Precision engineering using state of the art technology ensures an exact fit to the shape and contour of your vehicle's floor. The deeply molded chevron-shape tread pattern channels dirt, mud and snow away from the driver to keep shoes and pant legs clean. It also contains the movement and sloshing around of any trapped water. The high perimeter wall offers a large footprint and maximum interior protection and containment. Unlike ordinary liners that utilize an inconsistent vacuum thermoform process and slippery lower grade plastic these liners are high pressure injection molded from OE-quality Thermoplastic that looks and feels like rubber and provides a nonslip surface. Raised nibs on the bottom provide maximum retention and keep the liner in place. The unique self-sealing floor hook attachment feature helps to prevent dirt and moisture from getting through. Easy to remove and clean. Simply hose them off and go!!! The mat actually reseals itself around the hook!!! Patent pending.



12975.11 Cargo Liner, 97-06 Wrangler



Easy to clean design; simply hose off and go!



OFFICIAL LICENSED PRODUCT

MOBIL, DESI, DODGE, RAM, PLYMOUTH, RAM, and CHRYSLER vehicles, images and logos are trademarks of Chrysler Group LLC used under license to RuggedRidge. © Chrysler Group LLC 2011



NEW! Licensed Jeep® Logo Cargo Liners And Floor Liners Now Available For 76-95 CJ7/8 & Wrangler

Rugged Ridge® Floor Liners & Cargo Liners

Part #

| | |
|---|--------------|
| Floor Liner, Front, 97-06 Wrangler/Unlimited, Pair | 12920.11 |
| Floor Liner, Rear, 97-06 Wrangler/Unlimited, Pair | 12950.10 |
| Cargo Liner, 97-06 Wrangler/Unlimited | 12975.11 |
| Floor Liner, Front, 76-86 CJ7/CJ8, 87-95 Wrangler, Pair | 12920.21 |
| Cargo Liner, 76-86 CJ7, & 87-95 Wrangler | 12975.11 |
| Floor Liner Kit, Front & Rear, 97-06 Wrangler | 12987.10 |
| Floor Liner, Front, 76-86 CJ7/CJ8, 87-95 Wrangler, Pair, w/Jeep® Logo | DMC-12920.22 |
| Cargo Liner, 76-86 CJ7, 87-95 Wrangler w/Jeep® Logo | DMC-12975.22 |
| Cargo Liner, Black, Jeep® CJ2A 46-49, CJ3A 48-53, M38 48-53 M38A1 52-68, CJ3B 53-64, CJ5 53-81, CJ6 55-81, Non-tread pattern NEW | 13601.03 |



The deeply molded chevron shape tread pattern channels dirt, mud and snow away from the driver to keep shoes and pant legs clean. "Deep Tread" technology!

Self-sealing floor hook attachment feature helps to prevent dirt and moisture from getting through. The mat reseals itself around the hook!

The high perimeter wall offers a large footprint and maximum interior protection and containment.

Billet aluminum Wrangler Climate Control Knobs. These stylish knobs are easily installed by pulling off the factory knobs and pushing these back in their place. Choose red or blue colored inserts in the face of the knobs to illuminate at night and show their position.

BILLET ALUMINUM CLIMATE CONTROL KNOBS

| Billet Aluminum Climate Control Knobs | Part # |
|---|----------|
| 99-06 Wrangler/Unlimited, Blue Indicator Lights, Set of 3 | 11420.03 |
| 99-06 Wrangler/Unlimited, Red Indicator Lights, Set of 3 | 11420.04 |



11420.03 Climate Control Knobs, 99-06 Wrangler

11420.04

BILLET SHIFT KNOBS

Upgrade the look of your Jeep® with a billet aluminum shift knob from Rugged Ridge®. These highly polished shift knobs attach directly to your original equipment shifter with no drilling. Simply unscrew your current knob and replace it with the billet shift knob. There are two styles to choose from: a solid polished version and a shift pattern version. Do not forget to also replace the transfer case knob as well! The combination creates the ultimate look! Please measure your shift/transfer case threads before ordering.



5-Speed Shift Knob

11420.24 Transfer Case Knob

Billet Shift Knobs w/ Shift Pattern*

| | Size | Part # |
|---|-----------------------------|----------|
| Fits most 97-06 Wrangler & some 94-95 models, Each | 5 Speed, 10 mm x 1.5 metric | 11420.20 |
| Fits most 80-95 CJ/Wrangler & some 97-98 Wrangler, Each | 5 Speed, 3/8"-16 threads | 11420.22 |
| Transfer Case Knob, 87-95 Wrangler, Each | w/ NP231 transfer case | 11420.24 |

Billet Shift Knobs w/o Shift Pattern*

| | Size | Part # |
|---|--------------------|----------|
| Fits most 97-06 Wrangler & some 94-95 models, Each | 10 mm x 1.5 metric | 11420.23 |
| Fits most 80-95 CJ/Wrangler & some 97-98 Wrangler, Each | 3/8"-16 threads | 11420.21 |

* NOTE: please measure your gear shift thread size prior to ordering



CJ & Wrangler '76-06

ALUMINUM/STAINLESS INSTRUMENT KNOB SET

Give your boring dash controls a step up in style with these instrument knobs. Sold as a 6-piece set.

| Application | Finish | Part # |
|--------------------------|-------------------|----------|
| 76-86 Jeep® CJ, Set of 6 | Polished Aluminum | 11420.01 |
| 76-86 Jeep® CJ, Set of 6 | Black Aluminum | 11420.02 |
| 76-86 Jeep® CJ, Set of 6 | Stainless Steel | 11126.01 |
| 76-86 Jeep® CJ, Set of 6 | Black Steel | 11126.02 |



INTERIOR ROLL BAR TRIM KIT

NEW!

Everything you need for those off road adventures! This complete kit makes it easy to get all the necessary Roll bar accessories all in one place. Easy and economical!



Interior Roll Bar Trim Kit

76-86 CJ, 87-06 Wrangler, Black, 7 Piece Kit, Includes: Ultimate Grab Handles [pair], Fire Extinguisher Holder, Sport Bar Cup Holders [pair], Sport Bar Flashlight Holder, and Roll Bar Sun Glasses Holder **NEW**

Part #

12495.01

REPLACEMENT SUN VISORS

Replace those old, worn or missing sun visors with these original equipment replicas. Constructed of durable interior matching vinyl with a built in metal attachment rod. Sold in pairs. Easily mounts with the factory original mounting hardware [not included].



13312.01 13312.09 13312.15 13312.37

Replacement Sun Visors for Jeep® Wrangler (sold in pairs)

| Application | Black | Gray |
|----------------------|----------|----------|
| 87-95 Wrangler, Pair | 13312.01 | 13312.09 |
| 72-86 CJ, Pair | 13301.01 | 13301.09 |

| Application | Charcoal | Spice |
|----------------------|----------|----------|
| 87-95 Wrangler, Pair | 13312.15 | 13312.37 |
| 72-86 CJ, Pair | 13301.15 | 13301.37 |

FIRE EXTINGUISHER HOLDERS

Special designed holder incorporates thick nylon web straps that secures your Fire extinguisher to the roll bar. Straps are fully adjustable and secure with hook and loop fasteners. Holds one 3lb. fire extinguisher [not included].



13305.20

13305.21

| Roll Bar Fire Extinguisher Holder | Black | Red |
|--------------------------------------|----------|----------|
| For all Jeep® 3" Roll Bars, Each | 13305.21 | 13305.20 |
| For Early CJ & 1"-2" Roll Bars, Each | 63305.21 | 63305.20 |

ROLL BAR COAT HANGER KIT

11250.03

Makes hanging your coat or laundry easy. Attaches to the roll bar with two nylon straps. Sold in pairs.



| Roll Bar Coat Hanger | Part # |
|----------------------------|----------|
| For all Jeeps® w/Roll Bars | 11250.03 |

COMING SOON

97-06 SUN VISORS

| Sunvisors | Agate | Camel | Black |
|----------------------|----------|----------|----------|
| 97-02 Wrangler, Pair | 13313.09 | 13313.37 | - |
| 03-06 Wrangler, Pair | - | - | 13313.01 |

All images are subject to be representative. More detailed information is available online. *Check the web for the latest info!

ROLL BAR DRINK HOLDER



Padded nylon drink holders attach with quick release "hook & loop" straps and hold a variety of cups and water bottle sizes. Foam insulation keeps your favorite beverage cool in the hot summer sun. Packed in pairs for both front and back seat use.

DRINK CUP HOLDER



ROLL/PITCH INDICATOR



Each style features two gauges: left displays side by side angle and the right displays front to back angle. Each display has a graphic read out that shows angles in degrees for quick reference. Choose from

the Compass model that has a floating compass in the middle or the lighted version for night time use (some wiring required). Each attach to the dash of your Jeep® with automotive grade double sided tape or can be permanently mounted with screws.

CJ & Wrangler 76-06

Roll Bar Drink Cup Holder

Part #

| | |
|-----------------------------------|----------|
| For all Jeep® Roll Bars, Pair | 12101.51 |
| For Early CJ & 2" Roll Bars, Pair | 62101.51 |

Drink Cup Holder

Part #

| | |
|-------------------------|----------|
| 76-95 CJ/Wrangler, Each | 13306.01 |
|-------------------------|----------|

Clinometer

Part #

| | |
|--------------------|----------|
| With compass, Each | 13309.01 |
| With light, Each | 13309.02 |

TAILGATE STOP

This billet aluminum door stop incorporates a sliding arm that locks into place keeping your tailgate door open even on the most severe slopes.



Load your Jeep® with ease! Some drilling required to install on the inside of your tailgate.

ROLL BAR DOME LIGHT



Hard wired light illuminates the cab area of your Jeep®. Attaches to the roll bar with easy to use straps. No drilling required.

BACK SEAT HEATER

This 300 watt, 12 volt heater will warm your vehicle quickly keeping you and your passengers comfortable. Designed to fit on the rear wheel well of any Jeep®, this easy to use heater wires easily to your existing electrical system. Some drilling may be required.



Tailgate Stop

Part #

| | |
|----------------------|----------|
| 87-06 Wrangler, Each | 11238.11 |
|----------------------|----------|

Roll Bar Dome Light

Part #

| | |
|--|----------|
| For all Jeeps® Roll Bars | 11250.01 |
| Universal LED Interior Courtesy Light NEW | 11250.08 |

Back Seat Heater

Part #

| | |
|--------------------|----------|
| All Jeeps® & SUV's | 13150.01 |
|--------------------|----------|

REAR DUAL GRAB STRAP FOR JEEP®

Gives back seat passengers a place to hold on while on the trail. Constructed of durable nylon webbing with soft molded foam handles for ease of use and comfort. Easily attaches with hook and loop around the center roll bar or to factory mounts. No drilling required. Special side "pockets" create a handy spot for hanging clothes.

Rear Dual Grab Strap

Black

| | |
|------------------------------------|----------|
| All 87-06 Wrangler/Unlimited, Each | 13305.05 |
|------------------------------------|----------|



13305.05 Dual Grab Strap

REPLACEMENT CARPET

Nothing refreshes the inside of a vehicle like new carpet. This NEW design provides Tufted Polypropylene carpet with electronically surged edges that will not unravel. Polypropylene is a space-age polymer chosen for its rugged durability and resistance to chemical solvents and mildew. Full interior design includes tailgate and wheel well coverage. Features jute backing and driver side vinyl heel guard. Thanks to the sound deadening properties of the carpet, interior noise will also be reduced. The precut six-piece design is made for your vehicle to ensure proper fitment. Available in three popular and attractive colors to match your Jeep's® interior.



Replacement Carpet

Part #

| | |
|--------------------------------------|----------|
| 76-95 CJ7/Wrangler, Black, 6 pc. Set | 13690.01 |
| 76-95 CJ7/Wrangler, Gray, 6 pc. Set | 13690.09 |
| 76-95 CJ7/Wrangler, Honey, 6 pc. Set | 13690.10 |
| 97-06 Wrangler, Black, 6 pc. Set | 13691.01 |
| 97-06 Wrangler, Gray, 6 pc. Set | 13691.09 |
| 97-06 Wrangler, Honey, 6 pc. Set | 13691.10 |



Electronically Surged Edge Will Not Unravel

ULTIMATE/DELUXE/NEOPRENE AND SPORT GRAB HANDLES



13505.04



13305.30



12680.28 Deluxe Grab Handle

13505.03 Ultimate Grab Handle

13305.01 Sport Grab Handle

Ultimate/Deluxe and Sport Handles, 55-06 CJ and Wrangler

Part #

| | |
|---|----------|
| Ultimate Grab Handles, Pair -Red | 13505.03 |
| Ultimate Grab Handles, Pair -Black | 13505.04 |
| Deluxe Grab Handles, Pair | 13305.02 |
| Sport Grab Handles, Pair | 13305.01 |
| Neoprene Wrapped Deluxe Grab Handles, Passenger/Driver Side Roll Bar, Pair -Black | 13305.30 |
| Neoprene Wrapped Deluxe Grab Handles, Passenger/Driver Side Roll Bar, Pair -Red | 13305.31 |
| 97-06 Wrangler Neoprene Door Handle Cover & Deluxe Grab Handle Kit, Black | 13505.15 |

Constructed of tough nylon webbing with either a molded sure-grip handle (Ultimate), soft foam handle (Deluxe) or plain Nylon webbing (Sport). The Ultimate Grab Handles are available in two hot colors to accent the Jeeps® interior-Red & Black. Deluxe and Sport models fit all Jeep® roll bars and 3" roll cages with padding. Ultimate Grab Handles will fit 2" or 3" padded or un-padded roll bars. All designs are packed in pairs.

WINDSHIELD BRACKETS AND KNOBS



11127.01 interior Windshield Bracket, Stainless, 76-86 Jeep® CJ

Sold as a pair. Includes mounting hardware.

| Interior Windshield Brackets | Stainless | Black |
|------------------------------|-----------|----------|
| 76-95 CJ & Wrangler, Pair | 11127.01 | 11208.01 |

These threaded knobs are an important part of the windshield hinge mechanism. Why not add some flash to their functionality?

11304.01 Windshield Knob Chrome Plated Steel, 76-86 Jeep® CJ



| Windshield Bracket Knobs | Chrome Plated Steel | Black* |
|--------------------------|---------------------|----------|
| 76-86 CJ, Pair | 11304.01 | - |
| 76-86 CJ, Each | - | 13318.01 |

* Black knobs sold individually. Please order 2 if you need a pair.

STEERING COLUMN COVERS

This cover attaches to the dash and dresses up an otherwise boring area of the interior. Includes mounting hardware.

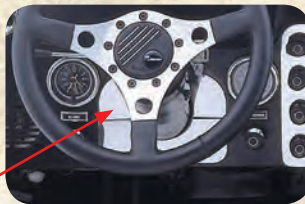

11128.01 Steering Column Cover, 76-86 Jeep® CJ

| Steering Column Cover | Stainless | Chromed Plastic |
|-----------------------|-----------|-----------------|
| 76-86 CJ, Each | 11128.01 | 18090.01 |

GRAB HANDLE AND GLOVE BOX

Make the interior of your Jeep® as unique as the exterior! Add a stainless glove box door. Or has your old glove box door or button just seen too much action? Replace either or both with brand new replacements. Doors available in either black or stainless.

| Grab Bar | Stainless | Black |
|---------------------------|-----------|----------|
| 55-86 CJ & Wrangler, Each | 11123.01 | 11203.01 |

11123.01 Grab Bar, Stainless, 55-86 Jeep® CJ

This grab bar bolts to the dash. Includes mounting hardware.



11228.01 Glove Box Door, Black, 76-86 Jeep® CJ



11813.11

11125.01 Glove Box Door, Stainless, 76-86 Jeep® CJ



13317.01

| Glove Box Door | Stainless | Black |
|----------------|-----------|----------|
| 76-86 CJ, Each | 11125.01 | 11228.01 |

| Glove Box Parts | Steel |
|----------------------------|----------|
| 72-86 CJ Glove Box Button | 11813.11 |
| 72-86 CJ Glove Box Bracket | 13317.01 |

GAUGE COVERS



11124.01 Gauge Cover, Stainless, 76-86 Jeep® CJ

Frame your gauges in a more attractive way with this easy to install gauge cover. Available in stainless steel or black, it's sure to dress up the interior of your CJ!

| Gauge Cover | Stainless | Black |
|----------------|-----------|----------|
| 76-86 CJ, Each | 11124.01 | 11204.01 |

WIPER MOTOR COVER

11122.01 Wiper Motor Cover



| Wiper Motor Cover, Stainless | Part # |
|------------------------------|----------|
| 76-86 CJ7, Each | 11122.02 |
| 68-75 CJ7, Each | 11122.01 |

REPLACEMENT DASH PANEL

These great new dash panels come finished in stainless steel or a durable black powder coat finish. The pre-cut gauge & accessory holes take all the guess work out of your restoration



13320.12



| Dash Panel | Black | Stainless Steel |
|---|----------|-----------------|
| Dash Panel Blank, CJ 76-86 NEW | 13320.10 | 11144.10 |
| Dash Panel with Gauge Cutouts, CJ 76-86 NEW | 13320.11 | 11144.11 |
| Dash Panel, with Speaker & Radio Cutouts, CJ 76-86 NEW | 13320.12 | 11144.12 |

DASH OVERLAY

Beautiful brushed stainless finish enhances the look of your 87-95 Jeep® Wrangler. This beautiful cover attaches with double sided tape and screws. Multiple piece design makes installation a snap.

11144.01 Dash Overlay, Stainless, 87-95 Wrangler



| Stainless Dash Overlay | Part # |
|--------------------------|----------|
| 87-95 Wrangler, 3 Pieces | 11144.01 |

RUGGED RIDGE® OVERHEAD STORAGE CONSOLE

The Rugged Ridge® Overhead Storage Console is the storage solution you have been waiting for! It instantly turns the area underneath your top into usable storage space without any interference or modification to your vehicle. Works with soft tops, hardtops, the top up, or the top down. The Overhead Storage Console is a fully enclosed storage compartment that installs easily without any tools or drilling. It is constructed from durable blow molded High-Density polyethylene (HDPE), so it is safer and lighter than steel. A non-skid pad is adhered to the inside of the console to help keep your gear from sliding around, and a mesh storage net helps keep it safely stowed yet easily accessible. The console measures 41.5"x2.5"x6.5" and offers more than 450 cubic inches of storage.



NEW!



Rugged Ridge® Overhead Storage Console

Part #

87-06 Wrangler **NEW**

13551.14

CJ & Wrangler 76-06

SUNGLASS HOLDER/ROLL BAR STORAGE

Another perfect organization solution for your Jeep®! Allows you to stow your sunglasses, wallet, GPS, or other small accessories within arms reach. A perfect size zipper storage pouch allows for added storage right where you need it. Attaches easily to your sport bar using hook and loop fasteners-no drilling required

NEW!



Sunglass Holder Description

Part #

All Jeep Wranglers **NEW**

12101.52

REPLACEMENT CENTER CONSOLES

Rugged Ridge® Consoles are the ultimate storage solution for your CJ or early model Wrangler. Each console is constructed of durable Jeep® interior matching vinyl wrapped around plastic coated hard wood to keep moisture out and provide a great looking addition to your Jeep®. Each console is hand made to ensure a tight, wrinkle free finish. All Rugged Ridge® Consoles feature a six can cooler, all mounting hardware and a dense foam arm rest for long life and a comfortable feel. Need lockable storage? No problem. All Rugged Ridge® Consoles incorporate a locking mechanism to deter access to the storage compartments. Available in three unique styles and sizes, Rugged Ridge® Consoles are the best storage solution available.

13103.37



13102.09



Rugged Ridge® II Consoles feature dual adjustable cup holders, removable soft sided CD holder, two oversized storage areas, back seat cup holders and a rear map pocket.

Ultimate Locking Consoles feature dual front cup holders, removable CD tray, can cooler, coin storage tray and sunglass holder.

13104.01

Replacement Center Consoles

| | Black | Gray | Black Denim | Spice |
|--|----------|----------|-------------|----------|
| Standard Locking Console, 76-95 CJ/Wrangler 24"Lx8.75"Wx12.5"H | 13101.01 | 13101.09 | 13101.15 | 13101.37 |
| Ultimate Locking Console, 76-95 CJ/Wrangler 27.25"Lx8.75"Wx12.5"H | 13102.01 | 13102.09 | 13102.15 | 13102.37 |
| Rugged Ridge® II Locking Console, 76-95 CJ/Wrangler 27.25"Lx8.25"Wx12.25"H | - | 13103.09 | 13103.15 | 13103.37 |
| Stereo Security Console, Textured Black, CJ 76-86, [YJ] 87-95 NEW | 13104.01 | 13104.09 | - | 13104.37 |

SUV/JEEP® STORAGE BAG

Custom designed to provide removable storage for Jeep® vehicles. Special size fits behind rear seat to organize and store your cargo. Constructed of durable vinyl with a zipper top and removable cargo dividers - easy to use shoulder strap included.

OFF ROAD ORGANIZER

Custom design for use in Jeep® glove boxes. Special pockets allow you to effectively organize owners manuals, maps, tire gauges, vehicle registration and more. Constructed of durable nylon in a tri-fold configuration.

Description

Part #

Jeep®/SUV Storage Bag, Universal all Jeep®

13551.01

Description

Part #

Off Road Organizer

13305.06



REPLACEMENT DOOR STRAPS/HANDLES

Upgrades/replaces factory hard door handles with tough nylon webbing and an easy grip handle. Installs directly into the factory mounting positions. The 97-06 model includes a special mounting tool to make installation easy.

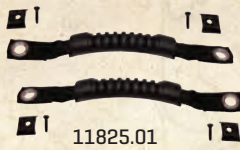

| Replacement Door Straps/Handles | Black |
|---|----------|
| 76-95 CJ/Wrangler Door Strap / Handle, Pair | 11825.01 |
| 97-06 Wrangler Door Strap / Handle, Pair | 11826.01 |

NEOPRENE GRAB HANDLE AND DOOR HANDLE COVERS

Protect and upgrade the look of your Wrangler with these easy to install door and grab handle wraps. Each wrap is constructed of durable neoprene and covers each door handle as well as the passenger side grab handle. Two door models have 3 pieces [Grab Handle and two door handles].



| Grab & Door Handle Kit | Black | Red |
|---------------------------|----------|----------|
| 97-06 Wrangler, 3 pc. Kit | 13305.52 | 13305.53 |
| 87-95 Wrangler, 3 pc. Kit | 13305.50 | 13305.51 |

BLACK, STAINLESS AND ALUMINUM ENTRY GUARDS

Protect your door threshold with these stylish entry guards. They enhance the look of your Jeep while providing the ultimate in protection. Attaches with durable double sided tape. Sold as a pair.

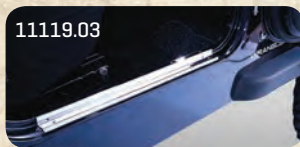

| Entry Guards | Stainless | Black | 24" Aluminum |
|-------------------------|-----------|----------|--------------|
| 97-06 Wrangler, Pair | 11119.03 | 11216.01 | 11238.21 |
| 76-95 CJ/Wrangler, Pair | 11119.02 | 11216.02 | 11238.20 |
| 55-83 CJ5, Pair | 11119.01 | - | - |

| Entry Guards | Part # |
|---|----------|
| Black, Jeep® CJ7 76-86, CJ8 81-86, Wrangler [YJ] 87-95 NEW | 11216.02 |

DOOR PANELS



| For Full Steel Doors | Part # |
|--|----------|
| [A] 87-95 Wrangler, Door Panel, Cinder [Black], Vinyl, LH NEW | 11840.01 |
| [B] 87-95 Wrangler Door Panel, Spice, LH NEW | 11840.37 |
| [C] 87-95 Wrangler, Door Panel, Cinder [Black], Vinyl, RH NEW | 11841.01 |
| [D] 87-95 Wrangler Door Panel, Spice, RH NEW | 11841.37 |

HALF DOOR INSERTS

Replaces factory hard Half Door Inserts. Available in three interior door matching colors. Sold individually or in sets of three.

| Half Door Inserts | Black | Gray | Spice |
|------------------------|----------|----------|----------|
| 87-06 Wrangler, Each | 11818.01 | 11818.09 | 11818.37 |
| 87-06 Wrangler, 3 Pack | 11819.15 | 11819.09 | 11819.37 |

HARD DOOR ARM REST

Replace your door pull strap with this easy to use arm rest. Soft padded vinyl design provides comfort while driving. Easy to install, simply remove current pull strap and mount to existing holes. No drilling required. Works on all Wrangler full steel doors.



11830.01 Hard Door Arm Rest, 87-95 Wrangler

| Hard Door Arm Rest, Full Hard Doors | Part # |
|-------------------------------------|----------|
| 87-95 Wrangler, Pair | 11830.01 |
| 97-06 Wrangler/Unlimited, Pair | 11830.02 |

TRAIL ARM RESTS



The most versatile and comfortable arm rest ever created for a Jeep®. Each arm rest provides comfortable cushioning while on the trail or just driving around town. Each arm rest fits all 87-06 Jeep® Wrangler hard half doors [with or without upper door in place] plus all 76-06 Bestop® Supertop™ half doors. Constructed of durable black nylon covered high density foam and powder coated steel for long life and great looks. Installation is quick and easy using the factory upper door mounting holes.



| Trail Arm Rests | Part # |
|--|----------|
| 87-06 Wrangler Hard Half Doors & All Bestop® 76-06 Supertop Half Doors, Pair | 11820.20 |
| 87-06 Wrangler Hard Half Doors & All Bestop® 76-06 Supertop Half Doors, Each [L,R] | 11820.21 |

ADJUSTABLE DOOR STRAPS

Keep those doors from swinging out too wide during wind storms on trail rides. Straps incorporate several "pockets" that allow for maximum adjustability. Each pack contains two straps.



| Adjustable Door Straps | Part # |
|-------------------------|----------|
| 76-06 CJ/Wrangler, Pair | 12103.01 |

DOOR BRACKET

This stainless steel door bracket not only dresses up your door opening, but it will far outlast the original piece. Includes door striker pin.



| Door Bracket | Stainless |
|-------------------------|-----------|
| 81-95 CJ/Wrangler, Pair | 11810.05 |

DOOR LIGHT SPRING CLIPS

These clips hold in the button that turns your interior lights on. Sold as a pair.

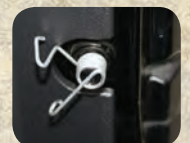

| Door Light Spring Clip | Part # |
|--|----------|
| Door Light Spring Clip, 97-06 Wrangler, Pair | 11819.01 |



WINDOW RAIN DEFLECTOR

New from Rugged Ridge, these side window air deflectors are aerodynamically designed to reduce wind noise while channeling airflow to keep your vehicles interior free of smoke, stale air and window fogging. The special design channels rain around your window while still allowing air to flow through your windows. These no-drill deflectors allow you to drive with windows cracked open but not let rain in! Constructed of durable scratch resistant smoked acrylic, these wind deflectors easily install with special automotive grade tape.



NEW!

| | |
|--|---------------|
| Rugged Ridge® Window Rain Deflector | Part # |
| Front, Smoked Acrylic, 97-06 Wrangler, pair NEW | 11351.10 |

WRAP AROUND BUG DEFLECTOR

Protect your windshield and hood from flying debris and bugs with this durable Bug Deflector from Rugged Ridge®. Constructed of durable shatter resistant smoked acrylic, this bug shield is designed to last the test of time. Installation is easy using tough tape and under hood screw attachments (some drilling required).



| | |
|----------------------------------|---------------|
| Wraparound Bug Deflector | Part # |
| 87-06 Wrangler, Smoke NEW | 11350.01 |

CJ & Wrangler 76-06

A. HEADLIGHT & TURN SIGNAL LIGHT COVERS

Get that cool blackout look while protecting your Jeep® from flying rocks and debris with these great looking Headlight and Turn Signal covers. Constructed of durable shatter resistant smoked acrylic, these tough covers can take quite a beating. Easy on-off attachment make these covers a snap to use. Note: Always take off these covers when driving at night. For offroad use only.

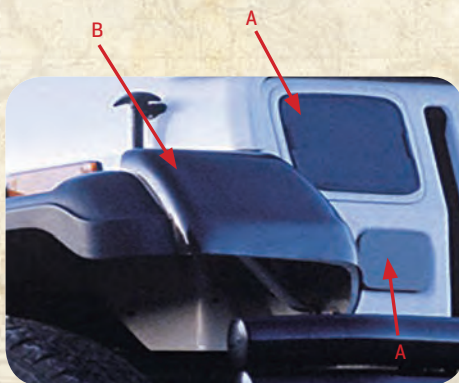

| | |
|--|---------------|
| Headlight & Turn Signal Light Covers, Smoke | Part # |
| 97-06 Wrangler | 11353.02 |

B. MOLDED FENDER GUARDS

Enhance and protect your front fenders with these easy to use Fender Guards. Constructed of durable shatter resistant smoked acrylic, these guards are designed to protect your fenders from rock chips and bugs while providing a great look. Easy to install with tough double sided automotive grade tape, there is no drilling required to install. Note: Will not fit Renegade models.

| | |
|-----------------------------|---------------|
| Molded Fender Guards | Part # |
| 97-06 Wrangler, Smoke | 11351.02 |
| 87-95 Wrangler, Smoke | 11351.01 |

FRONT EURO-GUARDS

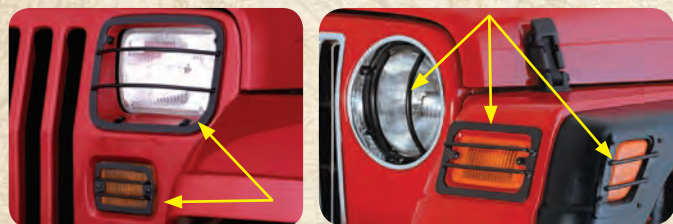

| | |
|--|--|
| 11230.02 Headlight & Turn Signal Guard Kit, 87-95 Wrangler | 11230.01 Headlight & 11231.01 Side Marker & Parking Light Guards, 97-06 Wrangler/Unlimited |
|--|--|

| | |
|--|---------------|
| Black Front Euro Light Guards | Part # |
| 97-06 Wrangler, Pair Head Light Guards | 11230.01 |
| 87-95 Wrangler, 4 pc. Kit Head Light & Turn Signal Guard Kit | 11230.02 |
| 97-06 Wrangler *, 4 pc. Kit Turn Signal & Side Flare Light Guard Kit | 11231.01 |

* N. America models only

Protect your headlights from debris and get that offroad look with a set of Rugged Ridge® Euro-Guards. Constructed of durable powder coated steel, these front Euro-Guards are designed to last. No drilling required for installation. Each kit comes with a pair of guards to cover both sides of the vehicle. The side marker light guards are a great complement to our front light Euro-Guards. Installation is easy and light visibility is not hampered. Sold in pairs. The turn signal light guards are designed to match our Headlight Euro-Guards. They feature the same great style and construction. They give a rugged look while protecting an important area. Sold in pairs.

BILLET AND REGULAR STONE GUARD KITS

Protect and enhance the look of your Jeep® with your choice of two types of stone guards. Each set includes six pieces to protect your headlights, taillights and turn signal indicators. The regular Stone Guards feature a durable wire mesh in durable black powder coat finishes. The Billet Stone Guards are also available in black and feature a contemporary look found nowhere else. Match these kits up with the Rugged Ridge® Grill inserts and headlight bezels and you have a complete front end enhancement.

TAILLIGHT GUARDS



| | | |
|-----------------------------|--------------|---------------|
| 11354.01 | 11354.02 | 11354.03 |
| Taillight Guards | Smoke | Chrome |
| 76-06 CJ / Wrangler | 11354.02 | 11354.03 |
| Taillight Black-Outs | | |
| 76-06 CJ/Wrangler | 11354.01 | - |

11236.20 Billet Stone Guard Set, 87-95 Wrangler



| | |
|--------------------------------|---------------|
| Stone Guard Kits | Part # |
| 97-06 Wrangler, 6 pc. Kit | 11236.01 |
| Billet Stone Guard Kits | |
| 97-06 Wrangler, 6 pc. Kit | 11236.21 |
| 87-95 Wrangler, 6 pc. Kit | 11236.20 |

Make your Jeep® CJ or Wrangler unique with genuine Rugged Ridge® black exterior accessories. All accessories are powder coated in a semi gloss finish to protect your investment against the elements. Every part or kit comes with complete hardware to ensure a trouble free installation. No matter if you choose our "Locking Hood Catch", "Gas Hatch Cover" or the complete "Hood Set", Rugged Ridge® Accessories truly change and upgrade your Jeep® dramatically.

HOOD SETS



| Hood Set, Black | Part # |
|-------------------------|----------|
| 98-06 Wrangler, Set | 11201.02 |
| 76-95 CJ/Wrangler*, Set | 11201.01 |

* 76-95 kits include hood catches

FOOTMAN LOOPS



| Footman Loop | Part # |
|--------------------------------|----------|
| 55-95 CJ/Wrangler, short, Each | 11227.01 |
| 87-95 Wrangler, long, Each | 11227.02 |

MIRROR RELOCATION BRACKETS

11025.02

Custom designed brackets bolt into existing holes on the windshield relocating your mirrors off the door. The perfect add-on accessory for those off road adventures where you do not want your doors.



| Mirror Relocation Brackets | Part # |
|---|----------|
| 03-06 Wrangler, Pair | 11025.03 |
| 97-02 Wrangler, Half & Full Doors, Pair | 11025.02 |
| 87-95 Wrangler, Half Doors, Pair | 11025.01 |
| 94-95 Wrangler, Full Doors, Pair | 11025.01 |

HOOD CATCHES

| Hood Catch, Black | Part # |
|-------------------------------------|----------|
| 97-06 TJ Hood Catch, Plastic, Each* | 11210.08 |
| 97-06 TJ Hood Catch, Plastic, Pair* | 11210.09 |
| 87-95 Wrangler Matte, Each | 11210.03 |
| 45-63 Vertical Mount, Each | 11210.02 |
| 42-95, Pair | 11210.01 |
| 04-06 Wrangler Unlimited, Each+ | 11210.07 |

* Includes Hood Mounted Bracket + Without Hood Mounted Bracket



11210.08



11210.01

LOCKING HOOD CATCHES



| Locking Hood Catches, Black | Part # |
|-----------------------------|----------|
| 97-06 Wrangler, Pair | 11210.10 |

DOOR HINGE KIT



| Door Hinge Kit, Black | Part # |
|--|----------|
| 87-06 Wrangler w/Half Doors, Kit | 11202.01 |
| 97-06 Wrangler w/Full Steel Doors, Kit | 11202.01 |
| 76-93 CJ/Wrangler w/Full Hard Doors, Kit | 11202.02 |

HOOD HINGES



11205.02 Hood Hinges
97-06 Wrangler

| Hood Hinges | Part # |
|-------------------------|----------|
| 76-95 CJ/Wrangler, Pair | 11205.01 |
| 97-06 CJ/Wrangler, Pair | 11205.02 |

LOWER DOOR HINGES



| Lower Door Hinges, Black | Part # |
|--------------------------|----------|
| 76-06 CJ/Wrangler, Pair | 11202.03 |

HOOD VENT COVERS



11206.03

| Hood Vent Cover | Part # |
|-------------------------|----------|
| 98-06 Wrangler, Each | 11206.03 |
| 97 Wrangler, Each | 11206.02 |
| 78-95 CJ/Wrangler, Each | 11206.01 |

WINDSHIELD HINGES/BRACKETS



11209.01

11209.02

| Black | Part # |
|--|----------|
| 97-06 Wrangler, Windshield Hinges, Pair | 11209.02 |
| 76-95 CJ/Wrangler, Windshield Hinges, Pair | 11209.01 |

WINDSHIELD LIGHT BRACKETS

Black powder coated brackets mount directly to the windshield hinge of your CJ or Wrangler. Allows for easy mounting of auxiliary lighting. Each bracket is custom designed for an exact mount. Sold in pairs.



11027.01

| Windshield Hinge Light Brackets | Part # |
|---------------------------------|----------|
| 97-06 Wrangler, Pair | 11027.02 |
| 76-95 CJ/Wrangler, Pair | 11027.01 |

WINDSHIELD TIE DOWN KITS

These windshield tie down kits are made of steel, not plastic, for durability.



| Windshield Tie Down Kits | Part # |
|---|----------|
| 97-06 Wrangler [1 footman loop, 2 hood bumper accents, & 2 washer nozzle covers], 5-Pc. Kit | 11104.03 |
| 55-95 CJ/Wrangler [2 footman loops & 2 windshield tie downs], 4-Pc. Kit | 11211.01 |

All images are subject to be representative. More detailed information is available online.

BILLET STYLE GAS COVERS

Create a custom look in just a few minutes. This special design fits directly over the existing gas cap opening. Available in locking and non-locking versions. They are specially treated to resist blemishes caused by gasoline or other hazardous chemicals. These covers install over the top of your factory gas cap into existing mounting points on 97-06 models. No drilling required.

| Application | Finish | Part # |
|----------------|------------------------------------|----------|
| 97-06 Wrangler | Black Aluminum, Each | 11425.02 |
| 97-06 Wrangler | Black Aluminum, Locking, Each | 11425.08 |
| 97-06 Wrangler | Black Painted Steel, Each | 11229.01 |
| 97-06 Wrangler | Black Painted Steel, Locking, Each | 11229.04 |



11229.01 Installed



CALIPER DUST COVERS

If you are tired of constantly cleaning your expensive custom wheels from brake dust? These caliper dust covers will do the trick. The covers come in pairs and are black powder coated for maximum rust protection. Installation is easy and well worth the investment to finally have clean wheels.

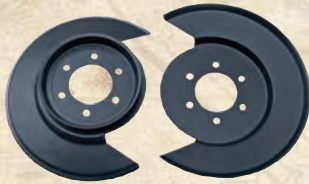

11212.01 Dust Covers

| Caliper Dust Cover | Black |
|----------------------------------|----------|
| 78-86 CJ w/ 2 bolt caliper, Pair | 11212.02 |
| 76-78 CJ w/ 6 bolt caliper, Pair | 11212.01 |

RADIATOR BUG SHIELDS



Protect your front grille from bugs and debris with these durable Radiator Bug Shields by Rugged Ridge®. Each externally mounted Bug Shield is perforated for unencumbered air flow and are available in black. All shields are bound by soft rubber to prevent vehicle scratching. Installation requires some drilling.

| Radiator Bug Shields | Black |
|----------------------|----------|
| 97-06 Wrangler, Each | 11213.03 |
| 87-95 Wrangler, Each | 11213.01 |
| 55-86 CJ, Each | 11213.02 |

BATTERY TRAY

Battery trays take a beating. Replace yours with this powder coated design from Rugged Ridge®. Mounts to factory mounting holes for ease of installation.



| Battery Tray | Black |
|----------------|----------|
| 76-86 CJ, Each | 11214.01 |

*See page C47 for Dual Battery Trays.

CJ & Wrangler 76-06

TOW HOOKS

A solid recovery point is a must when venturing offroad. These tow hooks mount securely to the vehicle and make attaching ropes, straps and cables easy and convenient.



| Tow Hooks, Black | Part # |
|--------------------------------|----------|
| 97-06 Wrangler, Front, Pair | 11236.03 |
| 97-06 Wrangler, Rear, Each | 11236.04 |
| 42-06 CJ/Wrangler, Front, Each | 11236.02 |

REAR EURO-GUARDS



Each Rugged Ridge® Rear Euro Taillight Guard is easy to install with no drilling required. On 76-06 models, just remove your taillight, slip on the Euro-Guard and replace the taillight. Constructed of durable powder coated steel or polished stainless steel for long life and great looks.

| Rear Euro Guards | Part # |
|-----------------------------------|----------|
| 76-06 CJ/Wrangler, Black, Pair | 11226.01 |
| 76-06 CJ/Wrangler, Titanium, Pair | 11301.01 |

TIRE STOP

Replace your bent or rusted tire stop with a brand new Rugged Ridge® factory style replacement tire stop. Powder coated for durability, this part will protect your taillight from your spare tire when opening the tailgate of your Jeep®.



| Tire Stop, Black | Part # |
|-------------------------|----------|
| 76-95 CJ/Wrangler, Each | 11217.01 |



BUMPERETTES

Restore the look of your Jeep® with these classic Bumperettes. Constructed of black powder coated painted steel for long life.



| Bumperettes | Part # |
|-------------------------|----------|
| 76-95 CJ Wrangler, Pair | 11215.01 |

LICENSE PLATE HOLDER

Having troubles getting to your gas cap because your license plate bracket is rusted or worn out? Replace your bent or rusted license plate holder with this brand new Rugged Ridge® factory style replacement bracket. The part is black powder coated for maximum protection against the elements.



| License Plate Holder | Black |
|----------------------|----------|
| 87-95 Wrangler, Each | 11233.01 |

TAILGATE HINGES



These tailgate hinges are a direct replacement for the weak, bland stock pieces. Includes all necessary hardware.

| Tailgate Hinges | Part # |
|-----------------------------|----------|
| 87-95 Wrangler, Pair | 11218.01 |
| 76-86 CJ Lower Hinges, Pair | 11207.01 |

Get the ultimate WOW factor with Rugged Ridge® polished stainless steel accessories! These beautiful bolt on accessories turn even the most worn Jeep® into a hot street machine. Constructed of prime 304 stainless steel that has been polished to a mirror finish, these accessories are built to last. 304 stainless steel is virtually rust proof guaranteeing that these parts will stand the test of time. All hardware is also constructed of stainless steel so the polished look you are going for is complete. Rugged Ridge® offers the most complete line of stainless accessories so you can truly customize the look of your vehicle. When you want the best, look to Rugged Ridge® Stainless Accessories!

STAINLESS STEEL HOOD KITS

Hood Kit, Stainless

| | Part # |
|----------------------------------|----------|
| 98-06 Wrangler, 8 pc. Kit | 11101.03 |
| 97 Wrangler, 8 pc. Kit | 11101.02 |
| 76-95 CJ & Wrangler, 9 pc. Kit * | 11101.01 |

* 1976-95 models include hood catch



11101.01 Hood Kit, 76-95 CJ & Wrangler

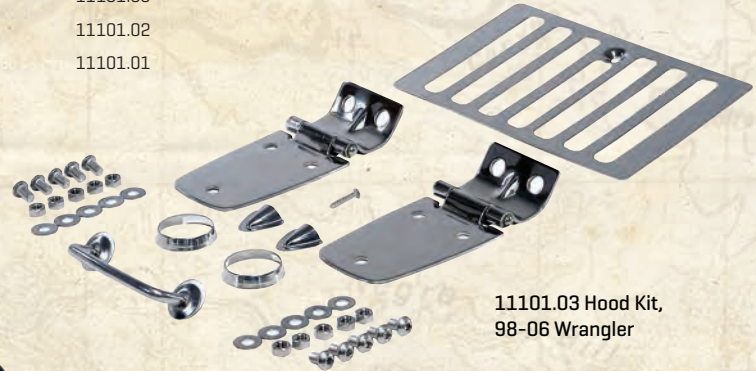

11101.03 Hood Kit, 98-06 Wrangler



WINDSHIELD TIE DOWN KITS

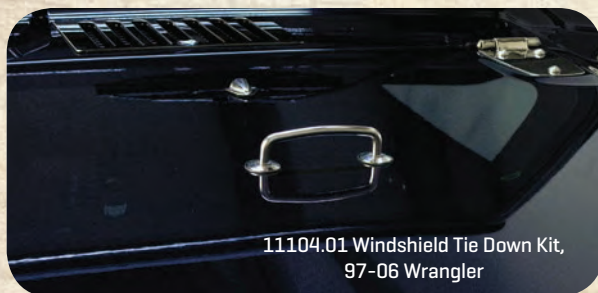

11104.01 Windshield Tie Down Kit, 97-06 Wrangler

Windshield Tie Down Kit, Stainless

| | Part # |
|---|----------|
| 97-06 Wrangler, Kit [Footman loop, windshield bumper covers] | 11104.01 |
| 55-95 CJ/Wrangler, Kit [2 Footman loops, 2 windshield tie down hoops] | 11104.02 |

FOOTMAN LOOPS

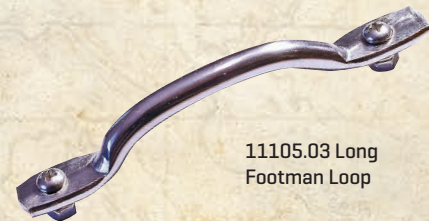

11105.03 Long Footman Loop

Footman Loop, Stainless

| | Part # |
|---------------------------------------|----------|
| 87-95 Wrangler, Long, Each | 11105.03 |
| 55-95 CJ/Wrangler, Short, Each | 11105.02 |
| 55-95 CJ/Wrangler, Short & Long, Pair | 11105.01 |

HOOD CATCHES



11116.02 Hood Catch, 97-06 Wrangler



11116.05 Hood Catch, 42-95 CJ & Wrangler



11116.01 Hood Catch, 42-95 CJ & Wrangler



11302.03 Locking Hood Catch, Chrome, 97-06 Wrangler

Available in polished 304 Stainless Steel or Chrome, these catches will keep your Jeep's® hood in place regardless of how rough the ride gets!

Hood Catch, Stainless

| | Part # |
|--|----------|
| 97-06 Wrangler, Pair [Cast Stainless] | 11116.02 |
| 42-95 CJ/Wrangler, Pair [Cast Stainless] | 11116.05 |
| 42-95 CJ/Wrangler, Pair [Plated Stainless] | 11116.01 |

Hood Catch, Chrome

| | Part # |
|---|----------|
| 97-06 Wrangler, Locking Pair [Chrome] | 11302.03 |
| 55-95 CJ5, CJ6, Wrangler, Pair [Chrome] | 11302.01 |

All images are subject to be representative. More detailed information is available online.

STAINLESS STEEL HINGES/BRACKETS



11112.02
Windshield Hinges, 97-06 Wrangler

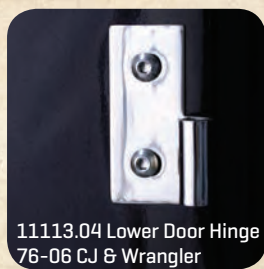

11113.04 Lower Door Hinge
76-06 CJ & Wrangler



11111.02 Hood Hinge,
97-06 Wrangler



11113.02-Door Hinges,
87-06 Wrangler

These hinges and brackets are one of those pieces that really shows off an attention to detail. They install quickly and easily and add a little bit of flash. Sold as a matching left/right hand pair. Includes all necessary hardware.

| Stainless Windshield Hinges | Part # |
|--|----------|
| 97-06 Wrangler, Pair - Hinge | 11112.02 |
| 76-95 CJ/Wrangler, Pair - Hinge | 11112.01 |
| Hood Hinges, Stainless | Part # |
| 97-06 Wrangler, Pair | 11111.02 |
| 76-95 CJ/Wrangler, Pair | 11111.01 |
| Stainless Door Hinges | Part # |
| 76-93 CJ/Wrangler w/Full Doors, 4 pc. | 11113.01 |
| 87-06 Wrangler w/Half Doors, 97-06 w/Full Doors, 4 pc. | 11113.02 |
| 94-95 Wrangler w/Full Steel Doors, 4 pc. | 11113.03 |
| Stainless Lower Door Hinge | Part # |
| 76-06 Wrangler, All, Pair | 11113.04 |

CJ & Wrangler 76-06



11117.04



11352.11



11352.02

HOOD TREATMENTS



11130.01

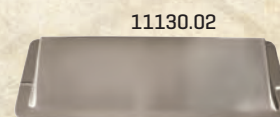

11130.02

| Hood Vent Cover, Stainless | Part # |
|----------------------------|----------|
| 98-06 Wrangler, Each | 11117.04 |
| 97 Wrangler, Each | 11117.03 |
| 76-95 CJ/Wrangler, Each | 11117.02 |
| 55-75 CJ, Each | 11117.01 |

| Air Scoop | Part # |
|------------------------------------|----------|
| 98-06 Wrangler, Chrome, Each | 11352.11 |
| 87-95 Wrangler, Chrome, Each | 11352.02 |
| 98-06 Wrangler, Stainless, Each | 11130.02 |
| 78-95 CJ/Wrangler, Stainless, Each | 11130.01 |

Note: Air Scoops can be mounted with opening facing either front or rear.

MIRROR RELOCATION BRACKETS

Custom designed brackets bolt into existing holes on the windshield, relocating your mirrors off the door. The perfect add-on accessory for those off-road adventures where you do not want your doors.

| Stainless Mirror Relocation Brackets (Pair) | Part # |
|---|----------|
| 03-06 Wrangler w/Half or Full Doors | 11026.03 |
| 97-02 Wrangler w/Half or Full Doors | 11026.02 |
| 87-95 Wrangler w/Half Doors & 94-95 Wrangler w/Full Doors | 11026.01 |



11026.02 Mirror Relocation
Bracket, 97-02 Wrangler



11026.03 Mirror Relocation
Brackets, 03-06 Wrangler

WINDSHIELD LIGHT BRACKETS

Easily and quickly mounts to your factory windshield hinge creating two great spots for off-road lighting. No drilling required for installation. Sold in pairs with all mounting hardware.

| Stainless Windshield Light Brackets (Pair) | Part # |
|--|----------|
| 97-06 Wrangler | 11028.02 |
| 76-95 CJ/Wrangler | 11028.01 |

11028.02
windshield
hinge light
Brackets,
97-06
Wrangler



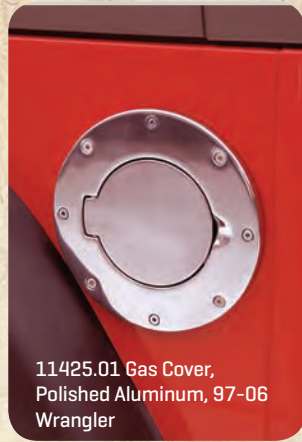

11425.01 Gas Cover,
Polished Aluminum, 97-06
Wrangler



11134.01 Gas Cover,
Stainless 97-06 Wrangler



11134.04 Gas Cover, Stainless,
97-06 Wrangler

STAINLESS & BILLET STYLE GAS HATCH COVERS

Create a custom look in just a few minutes. This special design fits directly over the existing gas cap opening. These tough gas covers are available in either stamped stainless steel, polished aluminum or chromed aluminum and are specially treated for resistance to gasoline and other chemicals. Unlike other designs on the market, installation does not require the removal of the tail light or internal gas cover components.

| Application | Finish | Part # |
|----------------------|----------------------------|----------|
| 97-06 Wrangler, Each | Stainless Steel, Locking | 11134.04 |
| 97-06 Wrangler, Each | Stainless Steel | 11134.01 |
| 97-06 Wrangler, Each | Polished Aluminum | 11425.01 |
| 97-06 Wrangler, Each | Polished Aluminum, Locking | 11425.07 |

FRONT EURO-GUARDS

Protect those expensive headlights, turn signals and parking lights from impact with the Rugged Ridge® Euro Light Guards. Each Euro Light Guard is easy to install with no drilling required. Made of polished stainless steel for a true attention to detail.



11142.01,
11142.02



11142.03

Front Euro-Guards

| | Part # |
|---|----------|
| 97-06 Wrangler, Headlight Guards, Pair | 11142.01 |
| 97-06 Wrangler, Turn Signal & Side Flare Light Guard Kit, 4 pc. | 11142.02 |
| 87-95 Wrangler, Head Light & Turn Signal Guard Kit, 4 pc. | 11142.03 |

GAS FILLER HOUSING

This stainless steel or chromed plastic gas filler housing will add a dash of class to your Jeep®. This is a direct replacement so no drilling is required.



11135.25 Chromed Plastic, 97-06 Wrangler

| Gas Filler Housing | Chromed Plastic | Price | Stainless |
|--------------------|-----------------|-------|-----------|
| 97-06 Wrangler | 11135.25 | | 11135.02 |
| 78-95 CJ/Wrangler | - | | 11135.01 |



Protect and enhance the look of your Jeep® with your choice of two types of stone guards. Each set includes six pieces to protect your headlights, taillights and turn signal indicators. Match these kits up with the Rugged Ridge® Grille inserts and headlight bezels and you have a complete front end enhancement.



11102.03



11102.04

BILLET AND REGULAR STONE GUARD KITS

| Stone Guard Kits | Stainless |
|---------------------------|-----------|
| 97-06 Wrangler, 6 pc. Kit | 11102.03 |
| 87-95 Wrangler, 6 pc. Kit | 11102.02 |
| 72-86 Wrangler, 6 pc. Kit | 11102.01 |
| Billet Stone Guard Kits | Stainless |
| 97-06 Wrangler, 6 pc. Kit | 11102.05 |
| 87-95 Wrangler, 6 pc. Kit | 11102.04 |

REAR EURO-GUARDS

Protect and upgrade the look of your Jeep® with a set of Rugged Ridge® Euro Taillight Guards. Each Rear Euro Taillight Guard is easy to install with no drilling required. On 1976-06 models, just remove your taillight, slip on the Euro Guard and replace the taillight. Constructed of durable powder coated steel or polished stainless steel for long life and great looks.



| Rear Euro Guards | Part # |
|-------------------------|----------|
| 76-06 CJ/Wrangler, Pair | 11103.01 |



CJ & Wrangler 76-06



TAIL GATE HINGES

These tailgate hinges are made from prime 304 stainless steel and polished to a mirror finish. They are a direct replacement for the weak, bland stock pieces. Includes all necessary hardware.

| Stainless Tailgate Hinges | Part # |
|---------------------------|----------|
| 97-06 Wrangler, Pair | 11114.03 |
| 87-95 Wrangler, Pair | 11114.02 |
| 76-86 CJ, Pair* | 11114.01 |

*Lower Tailgate Hinges

TIRE STOP



Protect your taillight from your spare tire when opening the tailgate of your Jeep®.

| Stainless Tire Stop | Part # |
|---------------------|----------|
| 76-95 CJ / Wrangler | 11140.01 |

REAR BODY CORNER GUARDS



| Rear Body Corner Guards | Stainless |
|-------------------------|-----------|
| 1987-95 Wrangler | 11110.01 |



CJ HARD TOP HINGES

Got a CJ with a hard top? Dress it up with these Rugged Ridge® Stainless Hinges constructed of prime 304 stainless steel. Includes mounting hardware.

| Hinges | Stainless |
|----------------|-----------|
| 76-86 CJ, Pair | 11115.01 |



BUMPERETTES



Complete the look of your classic Jeep® with these Bumperettes. Classic bumperettes have been a part of the signature Jeep® styling for decades. Constructed of polished 304 stainless steel for long life. Bumperettes will protect your vehicle from those minor bumps and spring back for more. Sold as a pair. Includes mounting hardware.

| Stainless Bumperettes | Part # |
|-----------------------|----------|
| 76-95 CJ/ Wrangler | 11108.01 |

RADIATOR BUG SHIELDS

Protect your front grille from bugs and debris with these durable Radiator Bug Shields by Rugged Ridge®. All shields are bound by soft rubber to prevent vehicle scratching. Installation requires some drilling.



| Radiator Bug Shields | Part # |
|----------------------|----------|
| 97-06 Wrangler | 11106.03 |
| 87-95 Wrangler | 11106.02 |
| 55-86 CJ | 11106.01 |

BRAKE DUST SHIELDS

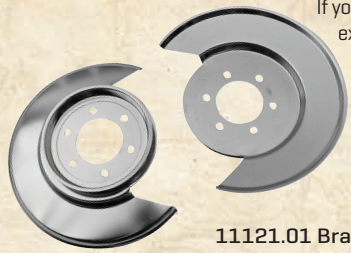

11121.01 Brake Dust Shields

If you're tired of constantly cleaning your expensive custom wheels from brake dust, these caliper dust covers will do the trick. The covers come in pairs and are made of stainless steel for maximum rust protection.

Brake Dust Shields

| | Stainless |
|--|-----------|
| 78-86 CJ With 2 Bolt Caliper, Front, Stainless Steel, Pair | 11121.02 |
| 76-78 CJ With 6 Bolt Caliper, Front, Stainless Steel, Pair | 11121.01 |

ROCKER PANELS



Made of highly polished stainless steel, these rocker panels extend from the front fender to the back fender. No drilling is required.

Rocker Panel

| | Part # |
|----------------------|----------|
| 97-06 Wrangler, Pair | 11145.02 |
| 87-95 Wrangler, Pair | 11145.01 |

BATTERY TRAY



Battery trays take a beating. Replace yours with this stainless steel design from Rugged Ridge®. Mounts to factory mounting holes for ease of installation. See page C47 for Dual Battery Trays.

Battery Tray

| | Stainless |
|----------------|-----------|
| 76-86 CJ, Each | 11132.01 |



DOOR RETAINER CHANNELS



These half door retainer channels are the perfect way to give a finished look to half doors.

Stainless Half Door Retainer Channels

| | Part # |
|----------------------|----------|
| 87-95 Wrangler, Pair | 11146.01 |



11303.02

11303.01

11303.03

Tow Hooks

| | Part # |
|---|----------|
| 42-06 CJ/Wrangler, Front, Stainless, Each | 11141.01 |
| 97-06 Wrangler, Front, Chrome, Pair | 11303.01 |
| 97-06 Wrangler, Rear, Chrome, Pair | 11303.02 |
| 42-06 CJ/Wrangler, Front, Chrome, Each | 11303.03 |

TOW HOOKS

LICENSE PLATE BRACKET

Replace that worn and rusted license plate bracket with a new stainless one that will last for years.

11136.01

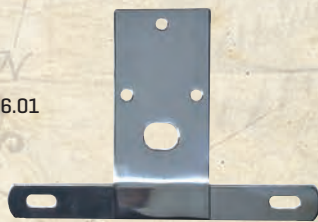

Stainless License Plate Bracket

| | Part # |
|----------------------|----------|
| 76-86 CJ, Each | 11136.01 |
| 87-95 Wrangler, Each | 11136.02 |

ANTENNA BASE COVER

This chromed plastic antenna base cover is a quick and easy way to add a touch of flash to your Wrangler. Simply unscrew your factory antenna and place the cover over the factory antenna base. Installation is easy thanks to the pre-attached durable double sided tape.

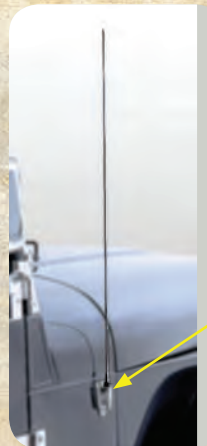

Antenna Base Cover

| | Part # |
|----------------------|----------|
| CJ/YJ Wrangler, Each | 17213.01 |

STAINLESS ANTENNA

The details make all the difference when it comes to building a unique vehicle. This stainless steel antenna mast is just the kind of touch that will set you apart from the crowd. Antenna only, base not included.



Stainless Antenna

| | Part # |
|----------------|----------|
| 97-06 Wrangler | 11131.01 |

RUGGED RIDGE® BODY ARMOR TJ

11650.01 Rear Corner Guards



CJ & Wrangler 76-06



Body Armor Kits for 97-06 Jeep® Wrangler

| Item/Feature | Components in Kit | Part # |
|-----------------------------|---|----------|
| 97-06 Wrangler, Kit (1) (6) | Rear Tall Corners, Pair [11650.01] Rocker Side Panel, Pair [11650.05] Front Frame Cover [11650.10] Rear Tailgate Sill [11650.15] Hood Stone Guard [11650.17] Front Fender Corners, Pair [11650.20] | 11650.50 |
| 97-06 Wrangler, Kit (2) (6) | Rear Tall Corners, Pair [11650.02] Rocker Side Panel, Pair [11650.05] Front Frame Cover [11650.10] Rear Tailgate Sill [11650.15] Hood Stone Guard [11650.17] Front Fender Corners, Pair [11650.20] | 11650.60 |
| 97-06 Wrangler, Kit (3) (6) | Rear Tall Corners, Pair [11650.01] Rocker Side Panel, Pair [11650.05] Front Frame Cover [11650.10] Rear Tailgate Sill [11650.15] | 11650.51 |
| 97-06 Wrangler, Kit (2) (6) | Rear Tall Corners, Pair [11650.02] Rocker Side Panel, Pair [11650.05] Front Frame Cover [11650.10] Rear Tailgate Sill [11650.15] | 11650.61 |
| 97-06 Wrangler, Kit (3) | Hood Stone Guard [11650.17] Front Fender Corners, Pair [11650.20] | 11650.52 |
| 97-06 Wrangler, Kit (3) | Front Frame Cover [11650.10] Rear Tailgate Sill [11650.15] | 11650.53 |

Body Armor Components 97-06 Wrangler

| Item/Feature | Part # |
|-----------------------------------|----------|
| Rear Tall Corner, Pair (1) (6) | 11650.01 |
| Rear Tall Corner, Pair (2) (6) | 11650.02 |
| Rocker Side Panel, Kit (3) (5) | 11650.05 |
| Front Frame Cover, Each (4) | 11650.10 |
| Rear Tailgate Sill, Each (4) | 11650.15 |
| Hood Stone Guard, Each (4) (7) | 11650.17 |
| Front Fender Guards, Pair (4) (5) | 11650.20 |

(1) cannot be used with Bushwacker brand rear flares or Rugged Ridge® All Terrain Flares
 (2) can be used with Bushwacker brand rear flares and Rugged Ridge® All Terrain Flares
 (3) can be used with Bushwacker brand or factory rear flares
 (4) also fits 03-06 Unlimited
 (5) will not fit Rubicon model
 (6) will not fit Unlimited model
 (7) may require under hood drilling

BODY TUB RAIL ARMOR

Hide those unsightly scuffs and scratches on your TJ factory belt rail with the new Rugged Ridge® Body Tub Rail Armor. These custom fit covers fit directly over your factory belt rails providing protection and a clean look. Each Rail armor attaches with Automotive Grade 3M adhesive and requires no drilling to install.

Body Tub Rail Armor

| Item/Feature | Part # |
|--|----------|
| 97-06 Wrangler, Pair NEW | 11650.40 |
| 04-06 Wrangler Unlimited, Pair NEW | 11650.41 |
| 97-06 Wrangler w/ Bestop® Supertop®, Pair NEW | 11650.41 |



WRANGLER HOOD SCOOPS 98-96

Constructed of durable ABS plastic in 3 different finishes, these great looking Hood Scoops give your Jeep® an aggressive look! Each Hood Scoop has been designed to complement the lines of the Jeep® while enhancing airflow. Choose from three finishes; Smoke, polished chrome or textured black. Each attaches with tough automotive grade tape to ensuring a long life. Each scoop can be used with the opening facing the window or facing the front of the Jeep®, depending on your preference.



11352.11



11352.10



11352.12

| Air Scoop | Part # |
|------------------------------|----------|
| 98-06 Wrangler, Chrome, Each | 11352.11 |
| 98-06 Wrangler, Smoked, Each | 11352.10 |
| 98-06 Wrangler, Black, Each | 11352.12 |



HOOD SCOOPS 78-95

Increase the efficiency of your heater and air conditioner with these easy to install Hood Scoops. Available in UV treated chrome plastic, black UV treated plastic or durable smoked acrylic for long life and matching good looks. Ram Induction hood scoop is designed to provide maximum air flow to your passenger compartment. Installation is easy with double sided automotive grade tape. No drilling required. Mounts facing either direction.



11352.01



11352.02

| Hood Scoops | Black Ram/Air | Smoke | Chrome |
|----------------|---------------|----------|----------|
| 78-86 CJ | 13307.01 | - | - |
| 87-95 Wrangler | 13307.01 | 11352.01 | 11352.02 |



13307.01 Ram Air Induction Scoop

| Grille Inserts | Chrome | Black |
|----------------------------|----------|----------|
| 1997-06 Wrangler, Set of 7 | 11306.02 | 11306.03 |
| 1987-95 Wrangler, Set of 7 | 11306.01 | 11306.04 |

| Billet Grille Inserts | Polished Aluminum | Black Aluminum |
|----------------------------|-------------------|----------------|
| 1998-06 Wrangler, Set of 7 | 11401.02 | 11401.03 |
| 1987-95 Wrangler, Set of 7 | 11401.01 | - |

GRILLE/BILLET INSERTS

Durable UV treated inserts enhance the front of your Jeep®. Available in your choice of Black or Chrome with or without aluminum billet inserts, these inserts add great styling and a unique appearance. All Rugged Ridge® inserts easily install without drilling or tools. Just click them in and go! Add on the NEW black or stainless Euro-Guards or black headlight bezels for the sharpest look on the market!



11306.02

REPLACEMENT HEADLIGHT BEZELS

Complete the look of your front end with these easy to install head light bezels from Rugged Ridge®. Each UV treated bezel easily attaches to factory mounting points creating a clean look. Matched up with the Rugged Ridge® Grille Inserts, you now have that HOT look.



12419.25

| Headlight Bezels | Black | Chrome |
|----------------------|----------|----------|
| 97-06 Wrangler, Pair | 12419.23 | 12419.08 |
| 87-95 Wrangler, Pair | 12419.24 | 12419.05 |
| 72-86 CJ, Pair | - | 12419.04 |



12419.23

All images are subject to be representative. More detailed information is available online.

Replacement Mirrors

Rugged Ridge® offers the most complete line of replacement mirrors for Jeep® vehicles found anywhere. All replacement mirrors are replicas of the factory original so you maintain that original equipment look while upgrading or replacing those worn mirrors.

FACTORY STYLE MIRRORS FOR 03-06 WRANGLER

Each replacement mirror uses only the finest materials ensuring a long life and ease of use. All replacement mirrors are offered in pairs or individually so you can replace one side or both depending on your needs.



11002.11

Factory Style Replacement Mirrors

| | Part # |
|---------------------------------|----------|
| 03-06 Wrangler, Pair* | 11002.09 |
| 03-06 Wrangler, Passenger Side* | 11002.10 |
| 03-06 Wrangler, Drive Side* | 11002.11 |

* Including Unlimited Models. Will also fit 97-02 for an updated look.

FACTORY REPLACEMENT MIRRORS

Wrangler mirrors are available in UV Treated black plastic, chrome plastic or polished Stainless Steel.



11002.03

For 87-02 Wrangler w/Factory Half Doors & 94-02 Wrangler w/Factory Full Doors



11016.01



11002.19

| | Stainless | Black | Chrome |
|---------------------------|-----------|----------|----------|
| OE Style Pair | 11005.08 | 11002.03 | 11010.04 |
| OE Style LH | - | 11002.05 | 11010.07 |
| OE Style RH | - | 11002.04 | 11010.06 |
| Dual Focal Point Pair | - | 11017.01 | 11018.01 |
| LED Dual Focal Point Pair | - | 11015.02 | 11016.02 |
| Heated Pair | - | 11002.20 | - |
| LED Heated Pair | - | 11015.20 | - |
| LED Pair | - | 11015.01 | 11016.01 |

| 87-95 Wrangler w/Full Steel Doors | Part # |
|---|----------|
| 87-95 Wrangler w/ Full Steel Doors, Pair NEW | 11002.19 |
| 87-95 Wrangler w/ Full Steel Doors, LH NEW | 11002.17 |
| 87-95 Wrangler w/ Full Steel Doors, RH NEW | 11002.18 |

SIDE MIRRORS FOR JEEP® CJ

CJ Style mirrors are available in painted black steel, polished Chrome or polished Stainless Steel. Replacement components also are available.



11005.01

Side Mirrors for Jeep® CJ

| | Stainless | Black | Chrome |
|---|-----------|----------|----------|
| 55-86 CJ [Pair] | 11005.01 | 11001.02 | 11010.01 |
| 55-86 CJ [LH] | 11005.03 | 11001.05 | 11010.03 |
| 55-86 CJ [RH] | 11005.04 | 11001.04 | 11010.02 |
| 55-86 CJ [LH] Convex | 11005.11 | 11001.09 | - |
| 55-86 CJ [RH] Convex | 11005.10 | 11001.06 | - |
| 55-86 CJ [Pair] Convex* | 11005.02 | 11001.03 | - |
| 41-64 Willys, Jeep® CJ, 5" Round Mirror, Pair | - | 11001.01 | - |

* with Convex Mirror Glass for Passenger Side

QUICK RELEASE MIRRORS

Run mirror relocation brackets, but dislike the limited visibility they offer with doors on? The mirrors mount to a bolt on bracket and are secured with a locking knob that allows for easy installation and removal. The long adjustable arms give you great visibility with your doors off or on! Available in durable black powder coat or stainless steel finish.



11025.10

NEW!

Quick Release Mirrors

| | Part # |
|--|----------|
| 97-06 Wrangler, Pair, Black NEW | 11025.10 |
| 97-06 Wrangler, LH or RH, Black NEW | 11025.11 |
| 97-06 Wrangler, Pair, Stainless Steel NEW | 11026.10 |
| 97-06 Wrangler, LH or RH, Stainless Steel NEW | 11026.11 |

REAR VIEW MIRRORS

11020.01



11020.02



Rear View Mirrors

| | Part # |
|----------------------------------|----------|
| 76-06 Jeep® CJ & Wrangler, Each* | 11020.02 |
| 41-75 Jeep® CJ, Each | 11020.01 |
| Mounting Glue, Each | 11021.01 |

* Includes mounting glue button.

JEEP® CJ STYLE MIRRORS FOR WRANGLER



11001.07

CJ Style Side Mirrors

| | Stainless | Black |
|---------------------------------------|-----------|----------|
| 87-95 Wrangler, CJ Style Mirror, Pair | 11005.06 | 11001.07 |
| 97-06 Wrangler, CJ Style Mirror, Pair | 11005.07 | 11001.08 |

BUSHINGS FOR MIRROR BRACKETS

1955-86 CJ Mirror Bushings

| | Part # |
|--------------------------------------|----------|
| Black Plastic, Each (need 2 per arm) | 11029.01 |
| Pair, Clear Anodized Aluminum | 11029.02 |
| Pair, Black Anodized Aluminum | 11029.03 |

11029.03



11029.01

MIRROR RELOCATION BRACKETS

Custom designed brackets bolt into existing holes on the windshield relocating your mirrors off the door. The perfect add-on accessory for those off-road adventures where you do not want your doors. Sold in pairs.



11025.02

Mirror Relocation Brackets

| | Stainless | Black |
|---|-----------|----------|
| 03-06 Wrangler, Pair | 11026.03 | 11025.03 |
| 97-02 Wrangler w/Half or Full Doors, Pair | 11026.02 | 11025.02 |
| 87-95 Wrangler w/Half Doors, Pair | 11026.01 | 11025.01 |
| 94-95 Wrangler w/Full Doors, Pair | 11026.01 | 11025.01 |

NEW XHD REPLACEMENT SEATING



Finally a seating design that fits late model [97-06] Wranglers without the use of an add-on adaptor bracket. This revolutionary new patent pending design is the first true replacement seating up-grade in the last 30 years! By offering a model year specific program for late model Wranglers, you only need to purchase the replacement seat and not be bothered with those expensive add-on adaptor brackets. Furthermore, while developing these new designs, we up-graded specific components of the seats creating the most durable seating program on the market today. The XHD seats, though they look similar, are an up-grade to our current designs.

Features and benefits of XHD Seating

- Special patent pending seat base design that allows for easy installation in all 97-06 Wranglers without any adaptor brackets! Saves you money, provides extra strength and provides true ease of installation!
- Each XHD Seat is designed to allow full functionality on 97-06 Wranglers. The unique design incorporates the factory front slider feature along with a built-in reclining mechanism for driver comfort. Only XHD Seating from Rugged Ridge® gives you these options on late model Wranglers!
- Dense foam pack and heavy duty raised spring design creates a more comfortable seating experience. This new "comfort design" has been created to ensure seat longevity and comfort all in one package
- Four heat treated grade eight 7/16" side bolts attach the seat base to the seat back. This increased bolt size [most seats use 8 MM bolts] strengthens the seat back and meets DOT standards for use with late model [03-06 Wrangler] seat belt attachments
- Tough automotive grade vinyl or woven fabric [XHD Off-Road Seat] and matching stitch patterns provide a great look in your Jeep® and tough "off road rated" performance.
- All lower seating areas have an expanded bolster area providing a wider seating area and more comfort. Wider bolsters also provide easier access/exit while entering and leaving the vehicle
- A low profile seating surface along with not having to use adaptor brackets provides less steering wheel interference and more comfort. These seats have been specially designed for the true Jeep® enthusiast!
- Infinitely adjustable reclining mechanism lets you customize the seat recline position for the ultimate in comfort
- Each seat offers an industry leading 3 year limited warranty

XHD ULTRA SEAT

- Our Full featured seat design with a removable and adjustable head rest.
- Expanded top and bottom side bolsters cradle the driver in comfort.
- Stylish racing design up-grades the look of any Jeep® interior.
- Constructed of durable automotive grade textured vinyl and available in four factory matching colors: Non-textured Black, Gray, Black Denim, Spice.
- Infinite recline mechanism.

| XHD Ultra Seat | Part # |
|--|----------|
| 97-06 Wrangler, Front Seat, XHD Ultra Seat with Recliner, Black NEW | 13414.01 |
| 97-06 Wrangler, Front Seat, XHD Ultra Seat with Recliner, Gray NEW | 13414.09 |
| 97-06 Wrangler, Front Seat, XHD Ultra Seat with Recliner, Black Denim NEW | 13414.15 |
| 97-06 Wrangler, Front Seat, XHD Ultra Seat with Recliner, Spice NEW | 13414.37 |

XHD RECLINING SEAT

- Low cost seat replacement option. Style matches the original Jeep® look with horizontal stitching and infinite recline mechanism.
- Great entry level price point for the 97-06 Wrangler.
- Constructed of durable automotive grade textured vinyl and available in three factory matching colors: Gray, Black Denim, Spice.

| XHD Replacement Seat | Part # |
|---|----------|
| 97-06 Wrangler, Front Seat, XHD Reclining, Gray NEW | 13412.09 |
| 97-06 Wrangler, Front Seat, XHD Reclining, Black Denim NEW | 13412.15 |
| 97-06 Wrangler, Front Seat, XHD Reclining, Spice NEW | 13412.37 |



13416.53
XHD Off Road Seat

NEW!



13414.15
XHD Ultra Seat

NEW!



13415.37
XHD Sierra Seat

NEW!



13412.09
XHD Replacement Seat

NEW!

XHD OFF ROAD SEAT

- A true off road design, this fabric and vinyl seat offers true performance while providing the comfort of our other XHD designs.
- Each Off-road Seat has a built in adjustable lumbar support that adjusts quickly and easily.
- Each seat has three seat belt harness cutouts for use with a multi-point racing seat belt harness.
- Constructed of durable automotive grade woven fabric with vinyl trim for long life and cool comfort in the summer.
- XHD Off-Road Seats are available in three, two color/fabric styles to complement your interior; Black with gray insert, black with red insert and black with black insert.
- Infinite recline mechanism.

| XHD Off Road Seat | Part # |
|---|----------|
| 97-06 Wrangler, Front Seat, XHD Off Road Seat, Black with Gray Insert NEW | 13416.09 |
| 97-06 Wrangler, Front Seat, XHD Off Road Seat, Black with Black Insert NEW | 13416.15 |
| 97-06 Wrangler, Front Seat, XHD Off Road Seat, Black with Red Insert NEW | 13416.53 |

XHD SIERRA SEAT

- A sport racing design, this seat features a special seat belt harness cutout with a integrated head rest.
- Expanded top and bottom side bolsters cradle the driver in comfort.
- Constructed of durable automotive grade textured vinyl and available in three factory matching colors: Gray, Black Denim, Spice.
- Infinite recline mechanism.

| XHD Sierra Seat | Part # |
|---|----------|
| 97-06 Wrangler, Front Seat, XHD Sierra Seat with Recliner, Gray NEW | 13415.09 |
| 97-06 Wrangler, Front Seat, XHD Sierra Seat with Recliner, Black Denim NEW | 13415.15 |
| 97-06 Wrangler, Front Seat, XHD Sierra Seat with Recliner, Spice NEW | 13415.37 |

SEAT ADJUSTER LEVER

These Seat Adjuster Levers replace the cable actuator in the OE seats to allow for the fold & tumble feature of the factory seats. The adjuster can operate from both the front or rear seat to allow easy access to the rear seat.

| Seat Adjuster Lever | Part # |
|---------------------------------|----------|
| 97-02 Wrangler, Each NEW | 13201.09 |
| 03-06 Wrangler, Each NEW | 13201.10 |

All images are subject to be representative. More detailed information is available online.

STANDARD REPLACEMENT HIGH BACK SEATS

Want all the strength and comfort of our reclining seat but without the recliner? Look no further! The Standard Replacement Seat from Rugged Ridge® offers all the great quality benefits of our reclining seat but we have removed the reclining mechanism. This low cost alternative gives you the value and quality you are looking for, but is priced less. Also available in the Standard series is our Low Back Replacement Seat. This seat is specially designed for those earlier Jeep® restoration projects and uses the original mounting hardware and bolts from the original seats.



13401.01

Standard High Back Front Seat For 76-02 Jeep® CJ/Wrangler *

| Color | Black | Blue | Tan | Nutmeg | Gray | Black Denim | Spice |
|---------------|----------|----------|----------|----------|----------|-------------|----------|
| Part # | 13401.01 | 13401.05 | 13401.04 | 13401.07 | 13401.09 | 13401.15 | 13401.37 |

NOTE: 97-02 Wranglers require front seat adapter brackets 13201.11 (for driver side) and 13201.12 (for passenger side) for these seats to mount on the factory seat brackets. See below.

FACTORY STYLE REPLACEMENT SEAT WITH RECLINER



13402.01 Factory Style Replacement Seat Reclining in Different Positions

Replacement seating that reclines just like the original! All Rugged Ridge® Seating is manufactured to exacting specifications to guarantee only the highest quality. Each seat is constructed of durable automotive grade vinyl that is designed to match your vehicles interior and all Rugged Ridge® rear seats. All frames are powder coat painted and welded to make sure it can take those off-road adventures and years of open air use. The foam pack and spring system used on all Rugged Ridge® Seats is extremely dense for long life yet soft enough for true comfort. Soft side bolsters "cradle" the driver making driving a pleasure. Each seat features an infinitely adjustable reclining mechanism to ensure proper driving position and the ultimate in comfort. All Rugged Ridge® seats feature a stylish stitch pattern and original equipment bolt pattern for ease of installation and a great original equipment look. Simply remove the old seat and bolt in the new!

Factory Style Replacement Seats with Recliner *

| | Black | Tan | Nutmeg | Gray | Black Denim | Spice |
|---|----------|----------|----------|----------|-------------|----------|
| 76-02 CJ/Wrangler | 13402.01 | 13402.04 | 13402.07 | 13402.09 | 13402.15 | 13402.37 |
| 76-02 CJ/Wrangler w/late model headrest | - | - | - | 13403.09 | 13403.15 | 13403.37 |
| All Suzuki® Samurai, Driver Side | - | - | - | 53420.09 | - | - |
| All Suzuki®, Passenger Side | - | - | - | 53421.09 | - | - |

SEAT ADAPTERS

Required equipment for installing replacement seats on 97-02 Jeep® Wrangler vehicles. Designed for both Rugged Ridge® and Outland replacement Jeep® seats.



| Seat Adapters | Part # |
|-------------------------------|----------|
| Driver Side, 97-02 Wrangler | 13201.11 |
| Passenger Side 97-02 Wrangler | 13201.12 |

*Not needed w/ XHD Seats

WARNING: Caution: replacement seating is offered for restoration or off-road use only. Replacement seats are provided by third party vendors and are not represented as meeting FMVSS standards.

SEAT RISER

Replace your worn seat risers or upgrade your current riser. They are designed for easy attachment of seat sliders (sold separately) which will attach to any aftermarket or OE Jeep® seat.



| Seat Riser | Part # |
|---|----------|
| Driver Side, 76-95 CJ/Wrangler, Each | 13201.01 |
| Passenger Side, 76-95 CJ/Wrangler, Each | 13201.02 |

REPLACEMENT SEAT SLIDER

Designed to be used with Rugged Ridge® or factory seat risers, these heavy-duty sliders allow the seat to slide forward and back. Each seat slider is sold separately so you will need two, one for each front seat!



| Seat Slider | Part # |
|-------------------------------------|----------|
| Seat Slider 76-95 CJ/Wrangler, Each | 13201.03 |

THE SUPER SEAT

Comfort, strength and stability all in one seat! Luxuriously soft side and bottom bolsters cradle you in comfort while providing stability on those off-road trails. Each seat features an infinitely adjustable reclining mechanism to ensure proper driving position and the ultimate in comfort.



13404.37

THE SPORT SEAT

13405.09

| Super and Sport Seats | Black | Gray |
|--------------------------------------|-------------|----------|
| 76-02 CJ/Wrangler, Super Seat, Each* | 13404.01 | 13404.09 |
| 76-02 CJ/Wrangler, Sport Seat, Each* | - | 13405.09 |
| | Black Denim | Spice |
| 76-02 CJ/Wrangler, Super Seat, Each* | 13404.15 | 13404.37 |
| 76-02 CJ/Wrangler, Sport Seat, Each* | 13405.15 | 13405.37 |

All Seats being installed on 97-02 Jeep® Wranglers require an optional front seat adaptor bracket: Drivers Side 13201.11 / Passengers Side 13201.12
WARNING: Caution: replacement seating is offered for restoration or off-road use only. Replacement seats are provided by third party vendors and are not represented as meeting FMVSS standards.

RRC RECLINING RACING SEAT

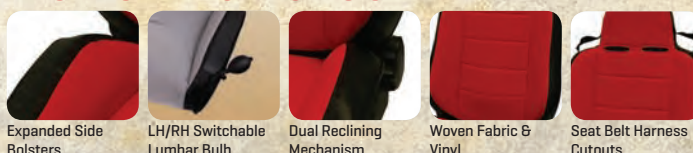

More features, more comfort, and the best pricing of any racing seat design. Each seat features dual reclining mechanisms allowing for infinite reclining positions. The special "Jeep® Specific" design uses ultra dense foam and steel construction for greater comfort and long life. Side bolsters have been slightly expanded and designed specifically for both lifted and non-lifted Jeep® vehicles. Special air adjustable lumbar support provides the most comfortable back support in a racing seat design. Each seat has three seat belt harness cutouts for use with a multi-point racing harness seatbelt. 1997-02 models require the Rugged Ridge® mounting bracket for installation.

Available in 3 Colors



13406.09

| RRC Reclining Racing Seat * | Red/Black | Black/Black | Gray/Black |
|-----------------------------|-----------|-------------|------------|
| 76-02 CJ & Wrangler, Each | 13406.53 | 13406.15 | 13406.09 |

STANDARD LOW BACK SEATS

Want all the strength and comfort of our reclining seat but without the recliner? Look no further! The Standard Replacement Seat from Rugged Ridge® offers all the great quality benefits of our reclining seat but we have removed the reclining mechanism. This low cost alternative gives you the value and quality you are looking for but is priced less. This seat is specially designed for those older Jeep® restoration projects and uses the original mounting hardware and bolts from the original seats.

13400.01
Standard Low
Back Seat, Black



13400.04
Standard Low
Back Seat, Tan



| Standard Low Back Front Seats * | Black | Tan |
|---------------------------------|----------|----------|
| 55-86 CJ, Each | 13400.01 | 13400.04 |

NOTE: 1955-75 models may require modification of vehicle

FOLD & TUMBLE REAR SEATS

Need more rear storage space in the back of your Jeep®? Simply "fold and tumble" the Rugged Ridge® Rear Fold and Tumble Seat and you create instant cargo space. Each seat is constructed of durable automotive grade vinyl that is designed to match your vehicles interior and all Rugged Ridge® front seats. Each frame is powder coat painted and welded to make sure it can take those off-road adventures. The foam pack used on all Rugged Ridge® Seats is extremely dense for long life yet soft enough for true comfort. Installation is easy with attachments to existing mounting points and minimal drilling required. Uses existing seat belts.

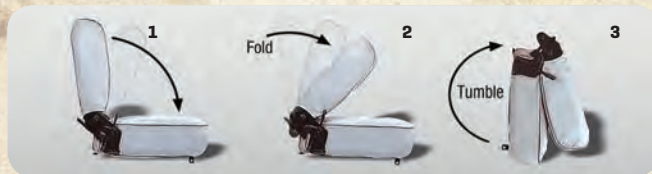

EASY AS 1-2-3

Just fold the seat back forward, and tumble the whole seat up and out of the way

13462.09 Fold & Tumble Rear Seat



| Fold & Tumble Rear Seats * | Black | Tan | Nutmeg | Gray | Black Denim | Spice |
|----------------------------|----------|----------|----------|----------|-------------|----------|
| 76-95 CJ/Wrangler, Each | 13462.01 | 13462.04 | 13462.07 | 13462.09 | 13462.15 | 13462.37 |
| 97-02 Wrangler, Each | - | - | - | 13463.09 | 13463.15 | 13463.37 |

STANDARD REAR SEAT



Looking for a tough rear seat that does not fold and tumble? Look no further as the Standard Rear Seat from Rugged Ridge® is the economical solution. Like the Fold and Tumble versions, these tough rear seats are constructed of durable automotive grade vinyl that is designed to match your vehicle's interior and all Rugged Ridge® front seats. The frame and all brackets are powder coat painted and welded to ensure a long life. Each seat is bolted directly to your vehicles floor board with minimal drilling required. Uses existing seat belts.

13461.01
Standard
Rear Seat



| Standard Rear Seats * | Black | Tan | Nutmeg | Gray | Black Denim |
|---------------------------|----------|----------|----------|----------|-------------|
| 55-95 CJ / Wrangler, Each | 13461.01 | 13461.04 | 13461.07 | 13461.09 | 13461.15 |

WARNING: Caution: replacement seating is offered for restoration or off-road use only. Replacement seats are provided by third party vendors and are not represented as meeting FMVSS standards.

TRI-LOCK OFFROAD SEAT BELTS



| Seat Adapters | Part # |
|---|----------|
| Tri-Lock Off Road Seat Belt , 3 Point Harness, Front, Black, Jeep Wrangler [YJ] 87-91 NEW | 13202.10 |
| Tri-Lock Off Road Seat Belt , 3 Point Harness, Front or Rear, Black, Jeep Wrangler [YJ] 92-95 NEW | 13202.11 |
| Tri-Lock Off Road Passenger Seat Belt , 3 Point Harness, RH Front or Rear, Black, Jeep Wrangler [TJ] 97-02 NEW | 13202.12 |
| Tri-Lock Off Road Passenger Seat Belt , 3 Point Harness, LH Front or Rear, Black, Jeep Wrangler [TJ] 97-02 NEW | 13202.13 |
| Tri-Lock Off Road Passenger Seat Belt , 3 Point Harness, RH Front or Rear, Black, Jeep Wrangler [TJ] 03-06 NEW | 13202.14 |
| Tri-Lock Off Road Passenger Seat Belt , 3 Point Harness, LH Front or Rear, Black, Jeep Wrangler [TJ] 03-06 NEW | 13202.15 |

All images are subject to be representative. More detailed information is available online.



13213.53 Front Seat Covers
Neoprene, 03-06 Wrangler

13263.53 Rear Seat Covers
Neoprene, 03-06 Wrangler



CUSTOM FIT NEOPRENE & POLY COTTON SEAT COVERS

Protect your Jeep's® interior with these two great Seat Cover options: Custom Fit Neoprene Seat Covers or Custom Fit UV treated Poly Cotton Seat Covers, both from Rugged Ridge®. These covers are constructed of either durable neoprene or tough poly cotton fabric creating the best looking custom seat cover available. Rugged Ridge® does not use that cheap stretch nylon on their seat covers! Neoprene [wetsuit material] is a great fabric to protect your seats from dirt, water and whatever mother nature can throw at you. Poly Cotton is a great fabric to protect your seats from dirt, sweat and heat from the sun. No more burned legs from hot vinyl seats! Each cover is custom tailored for your Jeep's® original equipment seat style making your seats look like they have been recently re-upholstered. Installation is easy with special designed elastic cords, nylon straps and hooks that attach to your seat and to the seat cover mounting points. Available in black on black, Gray on black, red on black [neoprene models only] and tan on black to complement virtually any Jeep® interior.

| Custom Neoprene Seat Covers | Black/Black | Black/Tan | Black/Gray | Black/Red |
|---------------------------------|-------------|-----------|------------|-----------|
| Front, 03-06 Wrangler, Pair | 13213.01 | 13213.04 | 13213.09 | 13213.53 |
| Front, 97-02 Wrangler, Pair | 13210.01 | 13210.04 | 13210.09 | 13210.53 |
| Front, 91-95 Wrangler, Pair | 13211.01 | 13211.04 | 13211.09 | 13211.53 |
| Front, 76-90 CJ/Wrangler, Pair | 13212.01 | 13212.04 | 13212.09 | 13212.53 |
| Rear, 03-06 Wrangler, Pair | 13263.01 | 13263.04 | 13263.09 | 13263.53 |
| Rear, 97-02 Wrangler, Pair | 13261.01 | 13261.04 | 13261.09 | 13261.53 |
| Rear, 80-95 CJ / Wrangler, Pair | 13262.01 | 13262.04 | 13262.09 | 13262.53 |



13243.09 Front Seat Covers Poly Cotton, 03-06 Wrangler



13282.09 Rear Seat Covers Poly Cotton, 03-06 Wrangler

| Custom Fit Poly Cotton Seat Covers | Black/Black | Black/Tan | Black/Gray |
|------------------------------------|-------------|-----------|------------|
| Front, 03-06 Wrangler, Pair | 13243.01 | 13243.04 | 13243.09 |
| Front, 97-02 Wrangler, Pair | 13240.01 | 13240.04 | 13240.09 |
| Front, 91-95 Wrangler, Pair | 13241.01 | 13241.04 | 13241.09 |
| Front, 76-90 CJ/Wrangler, Pair | 13242.01 | 13242.04 | 13242.09 |
| Rear, 03-06 Wrangler, Each | 13282.01 | 13282.04 | 13282.09 |
| Rear, 97-02 Wrangler, Each | 13281.01 | 13281.04 | 13281.09 |
| Rear, 80-95 CJ/Wrangler, Each | 13280.01 | 13280.04 | 13280.09 |

SEAT PROTECTORS



Available in Durable Neoprene or Tough UV Treated Poly Cotton

76-06 CJ/Wrangler Fabric Model

76-06 CJ/Wrangler Neoprene Model

Protect your seats from the elements with these easy to install Seat Protectors. Constructed of durable UV treated poly cotton fabric or soft water resistant neoprene to ensure comfort and protection. Each Seat Protector incorporates extra storage on the rear of the cover plus a removable drink holder. Easy to install, these covers fit over all bucket Jeep® seats including all Rugged Ridge® replacement seats. Sold in pairs to cover your entire front seating area.

| Seat Protector | Part # |
|--|----------|
| 76-06 All Jeeps® Black Fabric, Pair | 13235.01 |
| 76-06 All Jeeps® Gray Fabric, Pair | 13235.09 |
| 76-06 All Jeeps® Spice Fabric, Pair | 13235.37 |
| 76-06 All Jeeps® Black/Gray Neoprene, Pair | 13235.19 |

| Trail Bags | Part # |
|---|----------|
| Seat Back Trail Bag, Detachable, 76-06 CJ & Wrangler, Each | 13551.25 |
| Seat Back Trail Bag, 76-06 CJ & Wrangler, Each | 13551.26 |
| Sport Bar Trail Bag, Canvas Storage Bag, 92-06 Wrangler, Each | 11250.06 |
| Sport Bar Trail Bag, Canvas Storage Bag, 04-06 Wrangler Unlimited, Each | 11250.07 |
| Sport Bar Trail Tube Bag, 76-06 CJ & Wrangler, Each | 11250.05 |

Rugged Ridge® has the answer for your onboard storage needs. These soft-side storage bags feature heavy canvas construction and oversized zippers. Great for carrying recovery gear, spare parts, camping gear, clothes, or any other necessity for a wheeling trip. Rugged nylon straps keep the bags in place during even the most insane wheeling. Make the most out of your roll cage with a full complement of Rugged Ridge® storage bags. These bags are easy to install and take off and work with both hard tops and soft tops.



13551.25 Seat Back Trail Bag



11205.20



11238.06

| Flashlight Holders | Part # |
|--|----------|
| Sport Bar Flashlight Holder, 55-06 CJ & Wrangler, Each | 11205.20 |
| Mounting Brackets, for 1.5" Diameter Flashlights, Universal Application, drilling required, Pair | 11238.06 |

13550.04 Ultimate Roll Bar Coat Hanger

ULTIMATE ROLL BAR COAT HANGER

Makes hanging your coat or laundry easy. Attaches to the roll bar with two nylon straps.



| Ultimate Roll Bar Coat Hanger | Part # |
|-------------------------------|----------|
| 55-06 CJ & Wrangler, Pair | 11250.04 |



TRAIL NET KITS

Keep your stuff where you need it with Rugged Ridge® Trail Nets. These elastic nets attach to the glove box & dash and door & console areas with screw in snap heads and give you more storage in areas that are otherwise unused. Some drilling required.

| Trail Nets For 97-06 Wrangler | Part # |
|---|----------|
| Door & Console Trail Net Kit | 13551.21 |
| Glove Box & Dash Trail Net Kit | 13551.20 |
| Trail Nets, 5 Piece Kit, Black Includes: Dash, Glove Box, Console and [2] Door Nets NEW | 12495.11 |

All images are subject to be representative. More detailed information is available online.

RUGGED RIDGE® HEAVY DUTY 8,500 LB WINCH

- Durable 5.5 HP Series Wound motor for long life and extra pulling power
- Tough 3 stage planetary gear box with a 172.8:1 gear ratio delivering power and reliability
- Includes 94' of 5/16" diameter wire rope and latched hook
- Automatic load holding brake system [in the drum brake system]
- Exclusive light mount roller fairlead included- allows for easy no-drill mounting of up to 2 off road lights!
- Tough stainless hardware is used on the body of the winch to eliminate rust
- Each winch includes a durable 12' all weather cable remote solenoid box that can be mounted in multiple positions [over cable or over motor] and angles to accommodate most winch bumpers including the Rugged Ridge® XHD Bumper System!
- Limited 3 year warranty against manufacturing defects



8,500LB LINE SPEED & AMP DRAW-FIRST LAYER for Wire Cable and Synthetic Rope Winches

| Line Pull | Lbs | No Load | 2000 | 4000 | 6000 | 8000 | 8500 |
|---------------|--------|---------|------|------|------|------|------|
| Line Speed | Ft/min | 37.2 | 18 | 13.1 | 10.2 | 8.2 | 7.2 |
| Motor Current | amps | 70 | 190 | 260 | 335 | 410 | 425 |

8,500 LB. Heavy Duty Winch with Steel Cable | Part #

8,500 LB Heavy Duty Winch with Steel Cable | 15100.01



EXCLUSIVE LIGHT MOUNT ROLLER FAIRLEAD INCLUDED WITH BOTH WIRE CABLE WINCHES

RUGGED RIDGE® HEAVY DUTY 10,500 LB WINCH

ALL WEATHER 12' CABLE REMOTE INCLUDED WITH ALL WINCHES



10,500LB LINE SPEED & AMP DRAW-FIRST LAYER for Wire Cable and Synthetic Rope Winches

| Line Pull | Lbs | No Load | 2000 | 4000 | 6000 | 8000 | 10500 |
|---------------|--------|---------|------|------|------|------|-------|
| Line Speed | Ft/min | 29.5 | 14.4 | 11.9 | 9.85 | 8.7 | 7.2 |
| Motor Current | amps | 70 | 170 | 240 | 310 | 380 | 425 |

10,500 LB. Heavy Duty Winch with Steel Cable | Part #

10,500 LB Heavy Duty Winch with Steel Cable | 15100.10



RUGGED RIDGE® SYNTHETIC ROPE PERFORMANCE WINCHES!

We have taken the high quality features of our regular winch and replaced the steel cable with genuine Dymeema SK-75 Synthetic Rope for a lighter weight, high performance winch option. The synthetic rope used on Rugged Ridge® winches is custom designed for heavy duty use and combined with the included polished aluminum hawse fairlead and 12' hook, will provide the ultimate in pulling power.

Rugged Ridge® 8,500 Synthetic Rope Winch- 11/32" x 100', Breaking Force 16,550lbs

- Constructed with Dyneema SK-75 fiber from the Netherlands.
- Same high strength fiber used in ballistic body armor.
- Significantly stronger than same diameter steel cable and up to 40% stronger than Kevlar.
- 1/7 the weight of the same diameter wire rope.
- Will not splinter, kink or curl like wire rope & floats in water.
- Specially coated to be resistant to UV, abrasions, and chemical solvents.
- Heavy Duty 11/32" 12-strand braid with a breaking force of 16,550lbs
- Hawse fairlead included

ALL WEATHER 12' CABLE REMOTE INCLUDED FOR ALL WINCHES



8,500 LB Performance Winch with Synthetic Rope | Part #

8,500 LB Performance Winch with Synthetic Rope | 15100.02

ALL RUGGED RIDGE® SYNTHETIC WINCHES INCLUDE AN ALUMINUM HAWSE FAIRLEAD



Rugged Ridge® 10,500 Synthetic Rope Winch-3/8" x 94', Breaking Force 19,310lbs

- Constructed with Dyneema SK-75 fiber from the Netherlands.
- Same high strength fiber used in ballistic body armor.
- Significantly stronger than same diameter steel cable and up to 40% stronger than Kevlar.
- 1/7 the weight of the same diameter wire rope.
- Will not splinter, kink or curl like wire rope & floats in water.
- Specially coated to be resistant to UV, abrasions, and chemical solvents.
- Heavy Duty 3/8" 12-strand braid with a breaking force of 19,310lbs
- Protective sleeves keep line from overheating on winch drum.
- Hawse fairlead included

10,500 LB Performance Winch with Synthetic Rope | Part #

10,500 LB Performance Winch with Synthetic Rope | 15100.11

WARNING: WARNING: Read and understand all instructions and related Warnings, Cautions and Notices before attempting to install or use your Rugged Ridge® winch.

WHY SYNTHETIC WINCH ROPE?

Stronger and lighter, the two key elements of Synthetic Rope that make it the choice of competition off road vehicles everywhere. Rugged Ridge® high strength synthetic Winch Rope is constructed from genuine Dyneema SK-75 fiber imported from the Netherlands. This revolutionary fiber is the choice of off-road enthusiast worldwide. It is stronger and lighter than wire rope and never kinks or splinters! Our synthetic line is woven from twelve UV-treated strands, resulting in increased strength, and a power to weight ratio unmatched by wire rope. Each synthetic rope comes with a protective sleeve that prevents it from over heating on the winch drum, black powder coated latched hook, stainless steel thimble, and is pre-terminated end for ease of installation. Synthetic rope does not store energy like steel cables, and in the event of a failure it is much less likely to result in severe injuries caused by the whiplash of broken wire rope.



NEW!

- Significantly stronger than same diameter steel cable and up to 40% stronger than Kevlar.
- Same high strength fabric used in ballistic body armor.
- 1/7 the weight of the same diameter wire rope.
- Will not splinter, kink or curl like wire rope & floats in water.
- Protective sleeves keep line from overheating on winch drum.

Synthetic Winch Rope

| Synthetic Winch Rope | Part # |
|---|----------|
| Synthetic Winch Rope 11/32" x 100', Breaking Force of 16,550 lbs, Each NEW | 15102.10 |
| Synthetic Winch Rope 3/8" x 94', Breaking Force of 19,310 lbs, Each NEW | 15102.11 |

NEW!



ALUMINUM HAWSE FAIRLEAD

This Hawse fairlead will help guide the synthetic winch rope to and from the spool. *Required for synthetic rope. Not recommended for steel rope.

Aluminum Hawse Fairlead

| Aluminum Hawse Fairlead | Part # |
|--|----------|
| Aluminum Hawse Fairlead, 10-Inch, Each | 11238.01 |



WINCH COVER

Keep your winch looking as good as the day you bought it with the Rugged Ridge® winch cover. Constructed of durable vinyl with reinforced grommets. Custom fit for Rugged Ridge® Winches

Rugged Ridge® Winch Cover

| Rugged Ridge® Winch Cover | Part # |
|--|----------|
| Winch Cover, All Rugged Ridge® Winches NEW <small>* Will not fit UTV winches</small> | 15102.02 |



15102.01

WINCH CABLE HANDLE

The winch hook handle is the perfect solution for handling a winch cable. It is constructed of tough nylon webbing with a molded sure-grip handle. Perfect for getting a good solid grip of the winch hook when free spooling cable for a recovery and a safe way to respool your cable without endangering your fingers. Just slip your winch hook through the nylon webbing and you are ready to rock!

Winch Cable Handle

| Winch Cable Handle | Part # |
|-------------------------------------|----------|
| Winch Cable Handle, Each NEW | 15102.01 |

LIGHT MOUNT ROLLER FAIRLEAD

Turn your roller fairlead into an off road light mount! This revolutionary new design allows for two off road lights to be easily mounted while not interfering with the winch operation.

Light Mount Roller Fairlead

| Light Mount Roller Fairlead | Part # |
|--|----------|
| Light Mount Roller Fairlead, Each NEW | 11238.03 |

11238.03



NEW!

11238.05

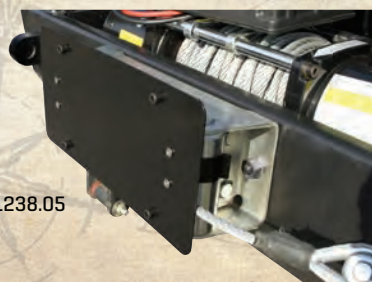

ROLLER FAIRLEAD LICENSE PLATE HOLDER

If your state requires a front license plate, we have a solution for you. Instead of drilling holes in your bumper or risking not running a front plate, this easy to install license plate holder attaches to your winch roller fairlead. Simply bolt your license plate to the bracket and snap the holder in place. Your license plate is now securely mounted yet easily removable for winching.

Roller Fairlead License Plate Holder

| Roller Fairlead License Plate Holder | Part # |
|---|----------|
| Roller Fairlead License Plate Holder, Each NEW | 11238.05 |

NEW!

RECOVERY GEAR

20,000 lbs Kit

- Durable Recovery Gear Bag.
- Heavy Duty 8" 20,000lb Snatch Block Pulley.
- Premium 2" x 30' 20,000lb Recovery Strap.
- Premium 3" x 6' 30,000lb Tree Trunk Protector Strap.
- Heavy Duty 9,500lb zinc coated pair of D-Rings.
- Winch Line Dampener.
- Pair of leather Recovery Gloves.

30,000 lbs Kit

- Durable Recovery Gear Bag.
- Heavy Duty 9" 30,000lb Snatch Block Pulley.
- Premium 3" x 30' 30,000lb Recovery Strap.
- Premium 3" x 6' 30,000lb Tree Trunk Protector Strap.
- Heavy Duty 13,500lb zinc coated pair of D-Rings.
- Winch Line Dampener.
- Pair of Leather Recovery Gloves.

The Rugged Ridge® Recovery Kit includes everything you need to help your buddy next time he gets stuck in the mud. The durable carrying case is filled with our most popular recovery products to make sure you can get out of those trouble spots quickly and safely. Each kit contains the following:



Recovery Gear also sold separately.

Rugged Ridge® Recovery Gear Kit

Part #

| | |
|--|----------|
| 20,000 lb, Recovery Gear, Kit, Universal Application | 15104.25 |
| 30,000 lb, XHD Recovery Gear Kit, Universal Application NEW | 15104.28 |

Don't Need Everything In Our Recovery Kit? Customize Your Your Own And Get Just What You Need!

Rugged Ridge® Recovery Gear

Part #

| | |
|--|----------|
| A Recovery Strap 3" x 30' 30,000 lbs, Each NEW | 15104.01 |
| A Recovery Strap 2" x 30' 20,000 lbs, Each NEW | 15104.02 |
| A Recovery Strap 4" x 30' 40,000 lbs, Each NEW | 15104.03 |
| B Tree Trunk Protector, 3" x 6' 30,000 lbs, Each NEW | 15104.10 |
| B Tree Trunk Protector, 2" x 6' 20,000 lbs, Each NEW | 15104.11 |
| C Recovery Bag, Each NEW | 15104.40 |
| D Recovery Gloves, Pair NEW | 15104.41 |
| E Winch Line Dampener, Each NEW | 15104.43 |
| F Heavy Duty 9,500 lb Zinc Coated D-Rings, Pair NEW | 11235.01 |
| F Heavy Duty 13,500 lb Zinc Coated D-Rings, Pair NEW | 11235.03 |
| G Heavy Duty 8" 20,000 lb Snatch Block Pulley, Each NEW | 11235.10 |
| G Heavy Duty 9" 30,000 lb Snatch Block Pulley, Each NEW | 11235.11 |

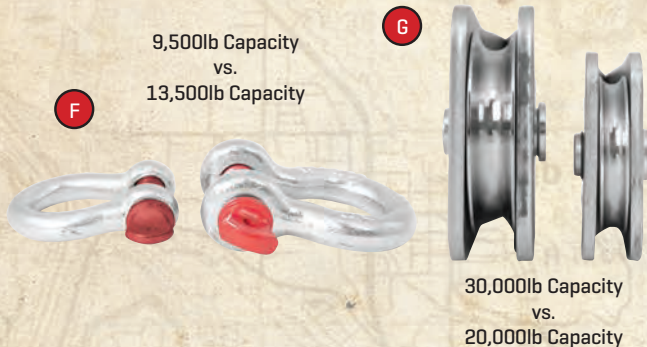

TIRE REPAIR KIT

The Rugged Ridge® Tire Repair Kit is essential recovery gear for any road or trailside tire repair. The kit includes: 2 sturdy aluminum handles, 2 reamers, 2 needles, 2 Allen head wrenches, and 25 self vulcanizing tire plugs all self contained in a heavy duty storage case. Be prepared for what ever the trail throws at you!



Rugged Ridge® Tire Repair Kit

Part #

| | |
|----------------------------------|----------|
| Tire Repair Kit, Each NEW | 15104.51 |
|----------------------------------|----------|

OFF ROAD JACK HANDLE RETAINER STRAP

This handy Off Road Jack Handle Retainer Strap pulls taut to secure the jack handle to the jack and eliminates obnoxious rattles. Simply loop the strap around the jack handle and pull it tight and go! Fits most off road style farm jacks including Hi-Lift.



Off Road Jack Handle Retainer Strap

Part #

| | |
|---|----------|
| Universal Application, Black NEW | 13305.60 |
|---|----------|

TIRE DEFLATOR KITS

Fully inflated tires are great for the road and gas mileage, but they deliver a washboard ride on the trail. Air down your tires for a softer ride and more tread grip. Rugged Ridge® offers two great kits to fit your lifestyle and budget. Made from 100% brass and are fully adjustable in 3 psi. increments. Once you find your desired setting you can lock the deflators where they bleed to the same tire pressure each and every time they are installed. So, you can deflate your tires quickly before heading out on the trail.

Rugged Ridge® Tire Deflator Kits

Part #

| | |
|---|----------|
| Adjustable Tire Deflator Kit, 4 Piece Kit NEW | 15104.53 |
| Keychain Tire Deflator Kit, 4 Pieces (Non-adjustable) | 15104.50 |



The Rugged Ridge® Tri Fold Recovery Shovel is a fully functional collapsible shovel that features two serrated edges for cutting or digging. The heavy duty black powder coated body is 23 inches when open and folds to a mere 9 inches. It can be stowed easily in any vehicle, but is still rugged enough for the toughest of jobs. Includes durable storage case.

TRI FOLD RECOVERY SHOVEL

Rugged Ridge® Tri Fold Off Road Shovel

Part #

| | |
|--------------------------------|----------|
| Tri Fold Off Road Shovel, Each | 15104.42 |
|--------------------------------|----------|

11238.10



NEW!

11238.12



WINCH MOUNT PLATE

The universal winch mounting plate is designed to use with OE bumpers. The raised winch plate is designed for use with tube bumpers and other after market bumpers. They can be used with any standard bottom mount winch with a 10" x 4.5" bolt pattern. Tough powder coated steel provides a long durable mount point.

Universal Winch Mount Plate

Part #

| | |
|--|----------|
| Universal Winch Mount Plate *, Each Fits: YJ 87-95, TJ 97-06, LJ 04-06 | 11238.10 |
| Raised Winch Plate, Each Fits: YJ 87-95, TJ 97-06, LJ 04-06 NEW | 11238.12 |
| Raised Winch Plate, CJ 76-86 NEW | 11238.13 |

* Does not work with Tube Bumper, use Raised Winch Plate for Tube Bumpers.

If you have installed larger tires on your rig then a matching spare tire is a must. The problem comes when you try to bolt that new monster tire/wheel combo on your factory spare tire mount. Rugged Ridge has the answer with the HD Tire carrier Mount. The HD Tire Carrier Mount is constructed of heavy 1/4" steel plate and mounts to the tailgate. The tire is relocated two inches up and out from the old mount for larger tire clearance [Maximum tire size=35"].

HEAVY DUTY TIRE CARRIER MOUNT



Heavy-Duty Tire Carrier & Spacer

Part #

| | |
|--------------------------------------|----------|
| Textured Black, 87-06 Wrangler, Each | 11585.01 |
|--------------------------------------|----------|

CAUTION: The tire carrier mount is designed to fit tires 35" in diameter or less.



HEAVY DUTY TIRE SPACER

The Spare Tire Spacer bolts to your existing factory spare tire mount and relocates the tire two inches up and out. Both the HD Tire Carrier and Spare Tire Spacer feature 5x4.5" and 5x5.5" wheel bolt patterns and tough powder coated black textured finish.

Heavy-Duty Tire Carrier & Spacer

Part #

| | |
|--|----------|
| Textured Black 76-06 CJ/Wrangler, Each | 11585.02 |
|--|----------|

CAUTION: The tire carrier spacer is designed to fit tires 33" in diameter or less. Do not exceed these tire sizes



COMING SOON

97-06 WRANGLER TUBE DOORS

Like the "doors off" feel but also want the added convenience and utility of having doors on the trail? Rugged Ridge® Tube Doors are constructed from durable 1.5" mandrel bent steel tube that is E-Coated primered and then textured powder coated for a long lasting finish. Tube doors help increase visibility when climbing obstacles and trail riding. The Tube Doors interchange easily with the factory steel doors and require no body modification for installation. They are light weight and small enough to be stored easily in back of the vehicle when not in use.



Tube Doors

Part #

| | |
|----------------|----------|
| 97-06 Wrangler | 11509.20 |
|----------------|----------|



NEW!



TUBE DOOR CARGO COVERS

The Rugged Ridge® storage solution features an assortment of five different storage pouches with internal storage compartments. The great Molle / Pals mounting system allows you to arrange the pouches however you wish, or grab them and go! They mount on any backpack that features the Molle / Pals system!

Molle Pal Tube Door Cargo Cover with Storage Bags

Part #

| | |
|---|----------|
| 97-06 Wrangler, Black, Fits Rugged Ridge® and Most Other Tube Door Designs NEW | 11509.10 |
|---|----------|

All images are subject to be representative. More detailed information is available online.

GAS TANK SKID PLATES

The last thing you want to happen on a trail ride is to lose the only thing that keeps your engine running: gas. That's why Rugged Ridge has custom designed this Skid Plate to protect the gas tank on 1987-06 Wranglers. This overbuilt skid plate is a must for those who want that extra bit of protection for their off road adventures. Constructed of durable 3/16" thick powdercoated steel with a rust resistant E-Coating, this Skid Plate is designed to take whatever the trail throws at you! Bolt-on installation using existing frame mounting locations. This skid plate replaces the factory skid plate.



18003.22 Gas Tank Skid Plate, 1997-06 Wrangler



18003.21 Gas Tank Skid Plate, 1987-95 Wrangler



18003.22 Gas Tank Skid Plate, 1997-06 Wrangler



CJ & Wrangler 76-06

| Gas Tank Skid Plates | Part # |
|---------------------------------|----------|
| 97-06 Wrangler, Each NEW | 18003.22 |
| 87-95 Wrangler, Each NEW | 18003.21 |

HEAVY-DUTY DIFFERENTIAL COVERS

Indestructible! You won't break these covers, we guarantee it. Made of 3/8" cast steel, painted black inside and out, these heavy-duty covers are designed to protect your differential and all its working parts for as long as you own your vehicle. These indestructible covers have been "44 caliber tested" - if they can take a bullet at point blank range [don't try this at home!], they can take all that the trail has to offer. Available for most popular Dana differential types and include extra reinforcement protection for the fill plug area. All mounting hardware and instructions are included for easy of installation.





16595.30 16595.35 16595.44

| Differential Cover | Part # |
|--------------------|----------|
| AMC 20, Each | 16595.20 |
| Dana 30, Each | 16595.30 |
| Dana 35, Each | 16595.35 |
| Dana 44, Each | 16595.44 |
| Dana 60, Each | 16595.60 |

HEAVY-DUTY DIFFERENTIAL SKID PLATES

Protect your factory differential cover with these heavy-duty skid plates. Designed to fit the contours of your stock differential cover. Constructed of durable 3/16" black powder coated steel, these skid plates will help you slide over obstacles and not get hung up. Includes replacement mounting hardware and instructions. Now available with the Jeep® logo stamped into the face as an Authentic Jeep® Licensed product.

| Heavy Duty Differential Skid Plates | Part # | w/ Jeep® Logo |
|--|----------|---------------|
| Dana 30 Diff. Skid Plate  | 16597.30 | DMC-16597.30 |
| Dana 35 Diff. Skid Plate  | 16597.35 | DMC-16597.35 |
| Dana 44 Diff. Skid Plate  | 16597.44 | DMC-16597.44 |



STEERING BOX SKID PLATE

Damage to the steering box can put a serious damper on a day of wheeling. That's why Rugged Ridge offers piece of mind with this tough skid plate. Constructed of durable 3/16" thick powdercoated steel with a rust resistant E-Coating, this skid plate will keep rocks and trail debris from damaging your steering box. The low profile design keeps ground clearance at a maximum. Installation uses existing mounting locations.



| Steering Box Skid Plate | Part # |
|---|----------|
| 87-95 Wrangler, Each NEW | 18003.11 |
| 97-06 Wrangler, Each NEW | 18003.12 |
| 04-06 Wrangler Unlimited, Each NEW | 18003.12 |

Outfitting a trail rig can add greater strain to the electrical system. Adding on a winch, air compressor, fog lights, driving lights, a spot light, electric fuel pump, and a stereo amp can really tax the battery. A great way to combat that strain is to install dual batteries. This is especially true when using a winch, which can draw big amps for an extended period. These kits are designed to mount two batteries in place of the factory single battery location. The trays and brackets feature a black powdercoated finish. These are mounting kits only and do not include any wiring. A suggested wiring diagram is included. 70-95 CJ & Wrangler kits place the batteries side-by-side and may be used with lead acid or cylindrical-style sealed gel cell batteries. 97-06 TJ Wrangler kits stack the batteries and are for use with cylindrical-style sealed gel cell batteries only due to the battery mounting direction.

DUAL BATTERY TRAY KITS



NEW!

| Dual Battery Tray Kits | Part # |
|-------------------------------------|----------|
| 70-90 CJ & Wrangler, Kit NEW | 11214.50 |
| 91-95 Wrangler, Kit NEW | 11214.51 |
| 97-06 Wrangler, Kit NEW | 11214.52 |

DUAL BATTERY RELAY KIT



NEW!

The Rugged Ridge® Dual Battery Relay Kit is the perfect companion to the Rugged Dual Battery Tray. This relay kit allows you to connect two batteries to your electrical system. Because the last thing you want when you're out of the trail or headed to the beach is a dead battery.

| Rugged Ridge Dual Battery Relay Kit | Part # |
|-------------------------------------|----------|
| 70-86 CJ, 87-06 Wrangler NEW | 17265.01 |

OFF ROAD JACK ROLL BAR MOUNTING BRACKET

Get your Hi Lift style jack out of the elements with this roll bar mounting kit from Rugged Ridge®. Storing your jack outside leaves it venerable to water, debris, ice and theft. These great new brackets allow you to secure your jack to the sport bar without sacrificing cargo area storage, and increase the longevity and function of your jack! The simple no drill installation allows for easy removal and storage of the jack.



| Off Road Jack Roll Bar Mounting Bracket | Part # |
|---|----------|
| 76-06 Wrangler NEW | 11586.02 |



NEW!

SOLID ROCKER GUARDS

Heavy-duty rocker panels are designed to provide maximum protection for your Jeep®'s most vulnerable points. Manufactured from 3/16" thick steel plate with a tough black textured finish, these heavy duty rockers can take a beating. Each features cutouts for use with offroad jack and a 2" step for easy access. To protect your vehicle's finish rubber gaskets are utilized to seal and protect the paint and body. For use with most aftermarket fender flares. Two part numbers cover 97-06 Wrangler and Wrangler Unlimited.



NEW!

| Solid Rocker Guards | Part # |
|---|----------|
| 97-06 Wrangler, Pair NEW | 11504.15 |
| 03-06 Wrangler Unlimited, Pair NEW | 11504.16 |

HOOD LIFT KITS

Eliminate the factory prop rod with a pair of gas charged hood lifts. This kit includes all the brackets and gas shocks needed to clean up the underhood appearance of your rig. This kit is also functional as the hood prop rod will no longer be in the way while working underneath the hood of your CJ or Wrangler. Easy installation.



| Hood Lift Kit | Part # |
|-----------------------------|----------|
| 72-06 CJ & Wrangler, Kit | 11252.50 |
| Hood Lift Replacement Shock | Part # |
| 72-06 CJ & Wrangler | 11252.80 |



All images are subject to be representative. More detailed information is available online.

TRANSFER CASE SLIP YOKE ELIMINATOR KIT/CV DRIVE SHAFTS

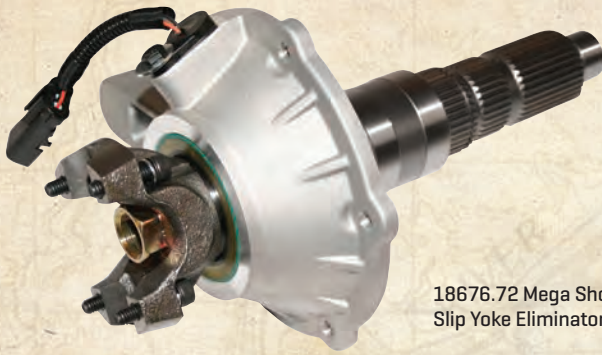

18676.72 Mega Short Slip Yoke Eliminator Kit

This kit is a MUST if you installed a 2" or taller suspension lift in your 1988-2006 Wrangler (not needed for body lifted Jeeps®). The kit fits all 1988 and up NP 231 transfer cases. A Slip Yoke Eliminator Kit [SYE] will eliminate the need to drop your transfer case in order to avoid drive train vibrations that are caused by taller suspension lift. The purpose of this kit is to replace the slip yoke portion of the NP 231 with a fixed yoke and CV-style drive shaft assembly. The Mega Short SYE [18676.72] is designed to be used in the same lift applications as the other standard SYE kit (2" and up). The main advantage to the new Mega Short SYE is that it allows for a much longer drive shaft to be used (additional 3"). This reduces drive shaft angle, improves bearing & U-joint life, reduces driveline vibrations. It also has a shorter and stronger main shaft design with improved oiling. Will not work with cable driven speedometers. Not for use with Rubicon models.



18676.60 Slip Yoke Eliminator Kit



16592.06 CV Equipped Drive Shaft for 97-06 Wrangler



WARNING: OEM slip yokes on 1988-2006 Jeep® Wrangler are not suitable for use with 2" or taller Rugged Ridge™ or other vendors' suspension lifts. Failure of slip yoke may result in damage to transfer case and/or loss of vehicle control. Use of this slip yoke eliminator kit is required for all suspension lifts 2" or taller. See additional product safety information and WARNINGS at back of catalog.

Transfer Case Slip Yoke Eliminator Kit

Part #

| | |
|---|----------|
| 88-06 Wrangler Slip Yoke Eliminator [with NP231 transfer case] *, Kit | 18676.60 |
| 88-06 Wrangler Mega Short Slip Yoke Eliminator with Vehicle Speed Sensor [with NP231 transfer case] *, Kit | 18676.72 |
| 88-06 Wrangler Mega Short Slip Yoke Eliminator without Vehicle Speed Sensor [with NP231 transfer case] *, Kit | 18676.70 |
| Speed Sensor for Mega Short Slip Yoke Eliminator Kit #18676.70, Each | 18676.71 |
| Replacement Bearing for Mega Short Slip Yoke Eliminator Kit #18676.70, Each | 18676.74 |
| 88-06 Wrangler, Output Shaft Oil Seal, Mega Short Slip Yoke Eliminator | 18676.75 |

* NOTE: A CV equipped drive shaft will be required for this conversion kit.

CV Equipped Drive Shafts

Part #

| | |
|---|----------|
| 88-93 Wrangler with up to 3" Lift, Rear, Each | 16592.01 |
| 88-93 Wrangler with over 3" Lift, Rear, Each | 16592.02 |
| 94-95 Wrangler with up to 3" Lift, Rear, Each* | 16592.03 |
| 94-95 Wrangler with over 3" Lift, Rear, Each* | 16592.04 |
| 97-06 Wrangler with 2"-6" Lift, Rear, Each | 16592.05 |
| 97-06 Wrangler with 3.5"-6" Lift, Rear (for Mega Short SYE only), Each | 16592.06 |

* NOTE: These drives shafts use 3-5/8" wide U-Joints, please verify U-Joint size before ordering.

LOWER CONTROL ARM MOUNTS FOR 1997-06 WRANGLER



Designed to replace and upgrade the weak OE front lower control arm mounts on 1997-06 Wranglers. These heavy-duty weld-on brackets provide a secure mount when driving off road. Greater wall thickness combined with a welded alignment cam provide extra support to the axle.

Lower Control Arm Mount

Part #

| | |
|---|----------|
| Lower Control Arm Mount, 97-06 Wrangler, Pair | 18273.01 |
|---|----------|

HEAVY-DUTY STEERING BOX MOUNT

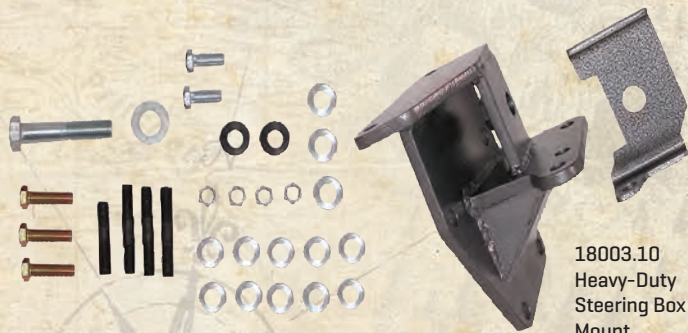

18003.10 Heavy-Duty Steering Box Mount

This overbuilt mounting system eliminates the two piece original equipment version that is prone to fatigue and cracking. With this mount, we have integrated a clamshell frame plate eliminating any potential weak points. Each kit is complete with all hardware and installation instructions. This is the last steering box mount you'll ever need to buy!

Heavy-Duty Steering Box Mount

Part #

| | |
|--------------------------------|----------|
| 76-86 CJ w/power steering, Kit | 18003.10 |
|--------------------------------|----------|

HEAVY-DUTY STEERING BOX BRACE

Heavy-duty design supports your steering box during those offroad adventures. Easy to install bolt on design.

HD Steering Box Brace

Part #

| | |
|--|----------|
| 76-86 Jeep® CJ w/ Power Steering, Each | 18021.02 |
|--|----------|

18021.02

SOLID MOTOR MOUNT

Rugged Ridge® Solid Motor mounts are built from durable 6061-T6 Aluminum with a tensile strength of 42,000 psi. Built to replace your wimpy OE rubber engine mounts to eliminate weight transfer on the trail and torque loss and binding that result in excess engine movement. Our mounts feature a protective black anodized finish for long life and corrosion resistance.



NEW!

Solid Motor Mount

Part #

| | |
|--|----------|
| 6061-T6 Aluminum, AMC V8, 304, 360, 390, 401, Jeep® CJ 72- 81, Pair NEW | 18390.20 |
|--|----------|

HEAVY-DUTY STEERING KITS & COMPONENTS

Beef up your ride with Rugged Ridge® steering components. This is a bolt-on solution for preventing bent tie rods from wheeling with larger tires. The tubes are 1-3/4" ID SAE 1018 steel that is cold rolled, pierced, and drawn through dies to produce a wall thickness of 3/4". This is true DOM tubing with no seams or welds to fail. Heavy-duty 7/8" rod ends feature standard tapered ends to fit stock knuckle applications. You get one ton strength without any modifications to your steering knuckles. The Heavy-Duty Crossover Steering Conversion Kit replaces the bump-steer prone inverted Y-type steering system. This kit connects the drag link to the end of the tie rod at the wheel, giving a better steering angle and better leverage. If your vehicle is lifted a crossover steering system is a must!

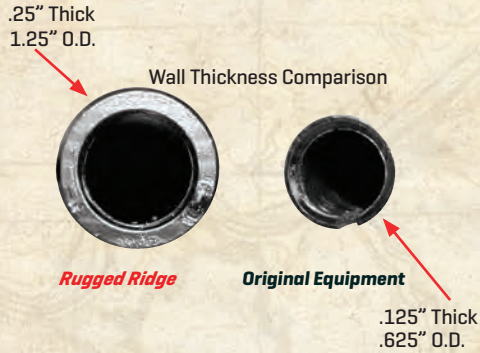

Heavy Duty Crossover steering systems prevent "bump steer"!

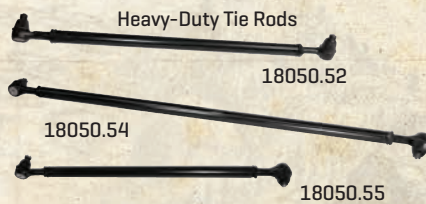

Heavy-Duty Kits

| | Part # |
|--|----------|
| Complete Heavy-Duty Crossover Steering Conversion Kit [Includes 4 Tie Rod Ends & Steering Dampener Bracket] 97-06 Wrangler, 84-01 Cherokee (w/under 4" lift), 93-98 Grand Cherokee (6 Cylinder only) | 18050.82 |
| Complete Heavy-Duty Tie Rod and Drag Link Kit [Includes 4 Tie Rod Ends] 72-83 CJ5, 72-75 CJ6, 76-81 CJ7, CJ8 Narrow Track [#18050.54 & #18050.56] | 18050.80 |
| Complete Heavy-Duty Tie Rod and Drag Link Kit [Includes 4 Tie Rod Ends] 82-86 CJ7 & CJ8 Wide Track [#18050.53 & #18050.55] | 18050.81 |
| Complete Heavy-Duty Tie Rod and Drag Link Kit [Includes 4 Tie Rod Ends] 87-95 Wrangler | 18050.83 |

* Not recommended for stock height suspensions

Heavy-Duty Steering Components

| | Part # |
|---|----------|
| Heavy-Duty Tie Rod [Includes 2 Tie Rod Ends] 97-06 Wrangler, 84-01 Cherokee, 93-98 Grand Cherokee (6 Cylinder Only), all with stock steering linkage only, not for use with kit #18050.82, Each | 18050.51 |
| Heavy-Duty Tie Rod [Includes 2 Tie Rod Ends] 82-86 CJ7 & CJ8 Wide Track, Each | 18050.53 |
| Heavy-Duty Tie Rod [Includes 2 Tie Rod Ends] 72-83 CJ5, 72-75 CJ6, 76-81 CJ7, CJ8 Narrow Track, Each | 18050.54 |
| Heavy-Duty Drag Links [Includes 2 Tie Rod Ends] 87-95 Wrangler with stock steering linkage only, not for use with kit #18050.83, Each | 18050.52 |
| Heavy-Duty Drag Links [Includes 2 Tie Rod Ends] 82-86 CJ7 & CJ8 Wide Track, Each | 18050.55 |
| Heavy-Duty Drag Links [Includes 2 Tie Rod Ends] 72-83 CJ5, 72-75 CJ6, 76-81 CJ7, CJ8 Narrow Track, Each | 18050.56 |
| Heavy-Duty Tie Rod, Cross Over 1987-95 Wrangler[for use in kit #18050.83], Each | 18043.28 |
| Heavy-Duty Tie Rod Steering Dampner Bracket [for use in kit #18050.82], Each | 18040.50 |

Heavy-Duty Tie Rod Ends

| | Part # |
|---|----------|
| Heavy-Duty Tie Rod End 7/8", Left Hand Thread, Each | 18043.10 |
| Heavy-Duty Tie Rod End 7/8" Right Hand Thread, Each | 18043.26 |
| Heavy-Duty Tie Rod End With Drag Link Connection, 7/8" Left Hand Thread, Each | 18043.27 |



RRC TUBULAR FLAT FENDERS

These over-built tubular fenders were designed for maximum suspension articulation while still maintaining a factory-style inner fender liner. Tough 0.120" wall tube is attached to 1/8" steel plating for one tough fender design. RRC Tubular Flat Fenders are direct factory replacements with a built in full fender liner [some drilling may be required] allowing for all factory engine accessories to be mounted by using the factory mounting hardware. Fenders are packed in pairs, primed for paint. Though these flares cover most tires, they are designed for offroad use and additional flare coverage may be needed for onroad use in some states. Two unique styles to choose from: Basic model requires greater installation [drilling] and more sheet metal work before painting. It also includes the side marker light housing. Upgrade model bolts directly on using factory inner liner has ground welds and is ready for paint. The upgrade version does not include the side marker light housing and is designed for offroad use only.



RRC Tubular Flat Fenders

| | Part # |
|--|----------|
| Basic Flat Fender, 97-06 Wrangler, Primer, Pair | 12004.61 |
| Upgraded Flat Fender, 97-06 Wrangler, Primer, Pair | 12004.53 |
| Basic Flat Fender, 87-95 Wrangler, Primer, Pair | 12004.60 |

HD CLUTCH LINK KIT



16919.30

Replaces the factory style L-bracket with retainer clip clutch rod with an upgraded spherical rod design. Allows for full clutch engagement during heavy body and frame flex situations while off road, where the factory design has tendencies to bind not allowing you to get into gear. Also can be used with up to 3" body lifted vehicles replacing the shorter factory clutch rod.

HD Clutch Link Kit

| | Part # |
|---|----------|
| 76-83 CJ5, 76-86 CJ7, 81-86 CJ8. Stock - Up To 3" Body Lift. NEW | 16919.30 |

HOOD LOCK

Special design virtually disappears into the grille. Cam lock design keeps people out of the engine compartment of your Jeep®. These clever applications install in minutes. An upgraded internal lock cover keeps ice and debris from fouling the lock mechanism.

Hood Lock Kits

| | Part # |
|----------------------|----------|
| 98-06 Wrangler, Each | 11252.04 |
| 97 Wrangler, Each | 11252.03 |
| 87-95 Wrangler, Each | 11252.02 |
| 72-86 Jeep®, Each | 11252.01 |



11252.01 Hood Lock, 1972-86 CJ



11252.02 Hood Lock, 1987-95 Wrangler



11252.03 Hood Lock, 1997 Wrangler



11252.04 Hood Lock, 1998-06 Wrangler



HID LIGHTING

We mated the brilliance of High Intensity Discharge bulbs with the rugged construction of our traditional halogen off road lights. The result is more efficient and powerful beam better capable of illuminating the night sky. HID lights are 2½ times more powerful than halogen lights and draw 60% less current than a standard 100W fog light. Our 6" and 5" HID Lights are constructed with heavy duty stamped steel housings, and are available in corrosion resistant black or stainless steel finish. Rugged Ridge® lights feature waterproof connections, internal ballast, and a reinforced multi-directional mounting base. The lights are available individually or in kits containing a pre-terminated wiring harness, relay, impact resistant stone guards and illuminated dash switch.

- 5", 6", 7" HID light assemblies available.
- 12V 35W 4200K HID Bulb.
- Internal ballast - no external ignition ballast to install.
- 2½ times more powerful than halogen bulbs.
- Draws 60% less current than a standard 100W fog light.
- HID Lights include impact resistant stone guard.
- The average life of an HID bulb is 2000 hours, compared to 500-1000 hours for a halogen unit.



Lights are available individually.
All include impact resistant stone guards



Kits include a pre-terminated wiring harness, relay and illuminated dash switch



15205.51



15206.01



15205.63

| HID Off Road Lighting | Single Light | 2 Light Kit w/ Wiring Harness | 3 Light Kit w/ Wiring Harness |
|--------------------------|--------------|-------------------------------|-------------------------------|
| 6" Round, Black | 15205.01 | 15205.51 | 15205.61 |
| 5" Round, Black | 15205.02 | 15205.52 | 15205.62 |
| 7" Round, Black, Plastic | 15205.03 | 15205.53 | 15205.63 |
| 5" Round, Black, Plastic | 15205.04 | 15205.54 | 15205.64 |
| 6" Round, Stainless | 15206.01 | 15206.51 | 15206.61 |
| 5" Round, Stainless | 15206.02 | 15206.52 | 15206.62 |

HALOGEN LIGHTING

Designed, engineered, and tested to stand up to the rigors of off road use, our lights are constructed with heavy-duty stamped steel housings, and crystal glass lenses set in shock absorbent weatherproof rubber gaskets. The brilliant 12V 100 watt halogen bulbs slice through fog, rain or snow to help illuminate the road even under the toughest conditions. Available in Round, Rectangular and Slim housings in either a black or stainless steel finish to best suit your application. Slim lights feature a narrow profile just 2 13/16" thick! This sleek design allows them to be mounted in places most lights won't fit. They are perfect for windshield and grille mount light systems. The lights are available individually or in kits containing a pre-terminated wiring harness, relay, impact resistant stone guards (white stone guards with stainless, black with black) and illuminated dash switch.



15207.51

| Rugged Ridge® Off Road Lights, 100W | Single Light | 2 Light Kit w/ Wiring Harness | 3 Light Kit w/ Wiring Harness |
|-------------------------------------|--------------|-------------------------------|-------------------------------|
| 6" Round, Black | 15207.01 | 15207.51 | 15207.61 |
| 5" x 7", Black | 15207.05 | 15207.55 | 15207.65 |
| 6" Slim, Black | 15207.10 | 15207.58 | 15207.68 |
| 6" Round, Stainless | 15208.01 | 15208.51 | 15208.61 |
| 6" Slim, Stainless | 15208.10 | 15208.58 | 15208.68 |



Slim lights feature a narrow profile - just 2 13/16" thick!

Rectangular lights give your vehicle a whole new look

| Halogen Light Accessories | Part # |
|---|----------|
| Off Road Light Cover, 6-Inch Black | 15210.53 |
| Off Road Light Cover, 6-Inch White | 15210.54 |
| Off Road Light Cover, 5x7-Inch Black | 15210.55 |
| Off Road Light Cover, 5x7-Inch White | 15210.56 |
| Off Road Light Cover, 6-Inch Black Slim | 15210.57 |
| Off Road Light Cover, 6-Inch White Slim | 15210.58 |
| Off Road Light Installation Harness, For Pair Of Lights | 15210.62 |
| Off Road Light Installation Harness, For Three Lights | 15210.63 |
| Halogen H3 Off Road Light Bulb, 100w Replacement | 15210.82 |
| Halogen H3 Off Road Light Bulb, 130w Replacement | 15210.83 |

Crystal glass lenses set in shock absorbent weatherproof rubber gaskets.

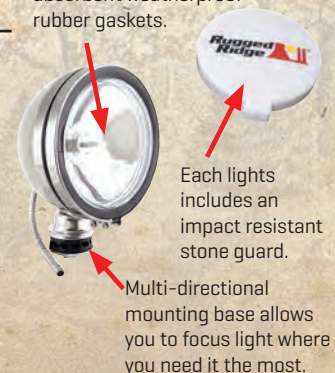

Each lights includes an impact resistant stone guard.

Multi-directional mounting base allows you to focus light where you need it the most.

All images are subject to be representative. More detailed information is available online.

HID LIGHT ACCESSORIES

| Accessories/Replacement Parts | Part # |
|--|----------|
| HID Lighting Covers, 7", Smoked | 15210.51 |
| HID Lighting Covers, 6", Black | 15210.50 |
| HID Lighting Covers, 5", Black | 15210.52 |
| HID Lighting Installation Harness for a pair of lights | 15210.60 |
| HID Lighting Installation Harness for three lights | 15210.61 |
| Replacement HID Bulb for 5" and 6" lights | 15210.80 |
| Replacement HID Bulb for 7" lights | 15210.81 |



DON'T LET NIGHT FALL ON YOUR ADVENTURE.
 CREATE YOUR OWN DAYLIGHT LONG AFTER THE SUN HAS GONE DOWN!

STANDARD HEADLIGHTS
 LOWER LIGHT OUTPUT IDEAL FOR CITY DRIVING

VS.

BUMPER MOUNTED HID LIGHTS
 EXTREME OUTPUT TO LIGHT UP THE TRAILS

CJ & Wrangler 76-06

ROCKER PANEL SWITCHES

- Rocker Style Switch.
- Heavy Duty Marine Grade surpasses OE Specifications.
- Available in four great colors: Red, Blue, Green and Amber.
- Switch illuminated in the "ON" Position.
- Three post terminal, 20-amp design works with most aftermarket accessories.

| Rocker Panel Switches | Part # |
|--------------------------------|----------|
| Rocker Switch Amber NEW | 17235.01 |
| Rocker Switch Red NEW | 17235.02 |
| Rocker Switch Blue NEW | 17235.03 |
| Rocker Switch Green NEW | 17235.04 |



ROCKER SWITCH HOUSING KIT

This housing kit allows you to mount 2, 3, or 4 switches to numerous dash locations by using a series of interlocking interchangeable pods.

| Rocker Switch Housing Kit | Part # |
|--|----------|
| Mounts 2,3 OR 4 Switches NEW | 17235.20 |
| Rocker Switch Housing Kit, Universal Application. Includes Four Interlocking Switch Housings and Four Different Color Rocker Switches NEW | 17235.89 |



ROCKER SWITCH PODS



| Rocker Switch Pods | Part # |
|--|----------|
| AC Vent Switch Pod, Black, Mounts Two Switches, Jeep® Wrangler [TJ] 97-06 NEW | 17235.50 |
| AC Vent Switch Pod Kit, Black, Jeep® Wrangler [TJ] 97-06, Includes Switch Pod and Two Rocker Switches (Amber & Red) NEW | 17235.80 |

CRYSTAL HB2/H4 CONVERSION HEADLIGHT

Replace your old sealed beam bulb headlights with these Crystal H4 Conversion Headlights. This two-piece headlight and bulb is brighter, more economical and environmentally friendly than a conventional sealed beam headlight. The headlights and bulbs are SAE / DOT compliant.



| Crystal HB2/H4 Headlight | Part # |
|--|----------|
| Crystal HB2/H4 Headlight, 7 Inch Round, H2 Bulb, All 55-86 CJ5, [TJ] 97-06 and Various Non Jeep® Applications, Pair, Includes Bulbs NEW | 12402.80 |
| 200mm Rectangular, H2 Bulb, [YJ] 87-95 and Various Non Jeep® Applications, Pair, Includes Bulbs NEW | 12402.82 |



LED TAILLIGHTS FOR 1946-75 CJ AND 1976-06 CJ & WRANGLER

Replace your dim factory tail lights with our brilliant LED tail light assemblies and get noticed! Rugged Ridge LED Tail Lights are DOT & SAE approved direct bolt in replacement tail lights, complete with impact resistant acrylic lenses, waterproof connections and polycarbonate housings. 1976-06 models feature 16 large brake, parking and directional LED's, 4 license plate light LED's and 22 brilliant white Back-Up LED's. While our 1946-75 units feature 9 large brake, parking and directional LED's, and 4 license plate light LED's. Our lights are Federal Regulation FMVSS108 compliant.

| LED Tail Lights for 1945-06 CJ & Wrangler | Part # |
|---|----------|
| LED Tail Light, LH, 76-06 Wrangler NEW | 12403.83 |
| LED Tail Light, RH, 76-06 Wrangler NEW | 12403.82 |
| LED Tail Light Pair, LH & RH, 76-06 Wrangler NEW | 12403.85 |
| LED Tail Light, LH, 46-75 CJ NEW | 12403.81 |
| LED Tail Light, RH, 46-75 CJ NEW | 12403.80 |
| LED Tail Light Pair, LH & RH, 46-75 CJ NEW | 12403.84 |



12403.83 for 1976-06 CJ/Wrangler Has 20 Large LED's



NEW!

12403.81 for 1946-75 CJ Has 13 Large LED's

All Circuitry Is Weather Resistant



11232.02, 1997-06 Wrangler

FRONT BUMPER LIGHT BARS

Rugged Ridge has engineered a durable and easy to install light bar that allows you to add auxiliary lighting to your factory Wrangler bumper. The light bar bolts to existing mounting holes and installs easily without cutting, drilling, or removing the bumper. With a few simple hand tools you will be able to install your light bar and mount up to three lights on your Jeep® while retaining your factory bumper. Lights not included.

| Front Bumper Light Bars | Part # |
|---------------------------------------|----------|
| 97-06 Wrangler, Textured Black, Each | 11232.02 |
| 97-06 Wrangler, Stainless Steel, Each | 11138.02 |

RUGGED RIDGE® WINDSHIELD LIGHT BAR

The three-piece light bar simplifies your installation dramatically because you won't run the risk of scratching up your windshield frame trying to mount a heavy one-piece bar with four lights onto your windshield hinges. With this bar you can install one piece at a time. The bar is Stainless Steel and packaged in a easy to ship box for your convenience.

| TJ Light bars | Part # |
|---------------------------------------|----------|
| 97-06 Wrangler, Stainless Steel, Each | 11138.01 |
| 97-06 Wrangler, Black, Each | 11232.01 |



NEW!

11138.01



NEW!

XHD OVERRIDER LIGHT CLAMPS

Light mount brackets for use with XHD part numbers 11540.14, 11540.16 and any other 2'-2.5" bumper override/tubes. Easy mount design makes these a must for mounting Rugged Ridge Lights to your bumper. Also available for smaller 1.5"-1.75" tube sizes. Sold as eaches.

| Light Clamps | Part # |
|---|----------|
| 3" for Tubular Bumpers NEW | 11503.81 |
| 2"-2.5" Off Road Mounting Bracket NEW | 11503.82 |
| 1.5"-1.75" Sport Light Bar Mount Bracket NEW | 11503.83 |

All images are subject to be representative. More detailed information is available online.

EUROGUARD KITS

Complete front and rear headlight and taillight protection packages now available! Get the complete look all in one package

12495.02



Euroguard Kits

Part #

| | |
|---|----------|
| 8 Piece Kit, Black, 97-06 Wrangler, NEW Includes: Black Headlight, Side Marker, Turn Signal and Taillight Guards | 12495.02 |
| 17 Piece Kit, Black, 97-06 Wrangler, NEW Includes: Grille Inserts, Headlight Bezels, and Black Headlight, Side Marker, Turn Signal, and Tail Light Guards | 12495.03 |
| 8 Piece Kit, Stainless Steel, 97-06 Wrangler, NEW Includes: Black Headlight, Side Marker, Turn Signal and Taillight Guards | 12495.04 |
| 17 Piece Kit, Stainless Steel, 97-06 Wrangler, NEW Includes: Grille Inserts, Headlight Bezels, and Black Headlight, Side Marker, Turn Signal, and Tail Light Guards | 12495.05 |

CJ & Wrangler 76-06



12495.03



12495.04



12495.05

FRONT BUMPER LIGHT BAR KITS



Front Bumper Light Bar Kit

Part #

| | |
|--|----------|
| 97-06 Wrangler, 5-IN HID Fog Lights, 5 Piece, Black NEW Includes: Bumper Light Bar, [3] 5-In HID Lights, and Wiring Harness with Switch | 12495.08 |
| 97-06 Wrangler, Slim Fog Lights, 5 Piece, Black NEW Includes: Bumper Light Bar, [3] 100 Watt Slim Lights, and Wiring Harness with Switch | 12495.09 |



12495.09



12495.08



12495.06

WINDSHIELD LIGHT MOUNT KITS



Windshield Light Mount Kit

Part #

| | |
|---|----------|
| 97-06 Wrangler, Slim Fog Lights, 5 Piece, Black NEW Includes: Windshield Light Mount Brackets, [2] 100 Watt Slim Lights, and Wiring Harness with Switch | 12495.06 |
| 97-06 Wrangler, 100 Watt Fog Lights, 5 Piece, Stainless Steel Mounts with Black Lights NEW Includes: Windshield Light Mount Brackets, [2] 100 Watt Lights, and Wiring Harness with Switch | 12495.07 |



12495.07

Want more horsepower, better throttle response, and improved acceleration?

A Rugged Ridge® Cold Air Intake System can boost your performance, while helping you keep extra cash in your wallet. Our polished aluminum mandrel bent intake tube replaces the restrictive factory air box to help improve fuel economy. A black powder coated heat shield separates the filter from engine heat, dirt and debris, as cold air is drawn through a high-flow conical air filter. Unlike other reusable air filters, our dry panel design never needs oiling, which keeps your mass airflow sensor from being damaged by excess oil! The simple bolt on installation gives you power you can feel, adding up to 10HP and 12ft lbs or torque, depending on application.

- Polished mandrel bent 6063 aluminum air intake tube.
- Simple no-drill installation bolts on using simple hand tools.
- Includes a high-flow conical dry panel filter that never needs oiling.
- Intake kit includes black powder coated heat shield
- Part # 17750.01 for 97-06 4L wranglers include a throttle Body Spacer as a part of the kit.
- Improves fuel economy up to 10%*
- Adds up to 10HP and 12ft lbs or torque**

| Rugged Ridge® Cold Air Intake Systems | Part # |
|---------------------------------------|----------|
| 1997-06 Wrangler 4.0L NEW | 17750.01 |
| 2003-06 Wrangler 2.4L NEW | 17750.03 |
| 1997-02 Wrangler 2.5L NEW | 17750.02 |
| 1991-95 Wrangler 4.0L NEW | 17750.04 |
| 1991-95 Wrangler 2.5L NEW | 17750.05 |

*See <http://www.fueleconomy.gov/feg/maintain.shtml>

COLD AIR INTAKES FOR JEEP®



17750.01 for 1997-06 Wrangler 4.0L

CONICAL AIR FILTERS



NEW!

| Conical Air Filter | Part # |
|--|----------|
| Conical Air Filter, Synthetic, for Cold Air Kit 17750.01, 17750.02 17750.04 and 17750.06, 77MM Flange, 270MM Length NEW | 17753.01 |
| Conical Air Filter, Synthetic, for Cold Air Kit 17750.03 and 17750.20, 70MM Flange, 270MM Length NEW | 17753.02 |
| Conical Air Filter, Synthetic, for Cold Air Kit 17750.05, 89MM Flange, 152MM Length NEW | 17753.04 |

THROTTLE BODY SPACER

The Rugged Ridge® Throttle Body Spacer raises the throttle body 1" above the intake manifold. The lift helps optimize power and performance by drawing in colder denser air. The large bore design allows your system to inhale a larger volume of air producing more horsepower and torque. It features solid aluminum construction with a slick anodized black finish, and is a bolt on performance adder for both 4.0L and 2.5L engines. [included in cold air kit 17750.01]



- Solid Aluminum Construction.
- Simple no-drill installation bolts on using simple hand tools.
- Includes mounting hardware, gaskets and spacers.
- Black Anodized Finish.
- Fits 91-06 Wrangler 4.0L & 91-02 2.5L

NEW!

| Throttle Body Spacer | Part # |
|---|----------|
| 1991-06 Wrangler 4.0L & 91-02 2.5L NEW | 17755.01 |

SYNTHETIC AIR FILTERS

Unlike other reusable air filters, our dry panel design never needs oiling, which keeps your mass airflow sensor from being damaged by excess oil! Rugged Ridge® performance high flow filters are made from a synthetic fabric and not cotton. Cotton filters are made porous and must be oiled to trap dirt and debris. But that oil reduces air flow through the filter and it can become easily clogged. No oil = No fuss, no mess and improved performance!



NEW!

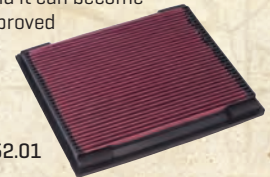

| Synthetic Air Filters | Part # |
|---|----------|
| Air Filter Synthetic, Round, CJ 232 OR 258 72-86, [YJ] 87-90 258 NEW | 17751.01 |
| Air Filter Synthetic, Round, CJ 72-81 5.0L NEW | 17751.02 |
| Air Cleaner Assembly, CJ 72-86 3.8L, 4.2L or 5.0L, YJ 87-90 4.2L, 14-Inch Chrome Round With Synthetic Filter NEW | 17751.52 |
| Air Filter Synthetic, Wrangler [TJ] 97-06 2.5L and 4.0L NEW | 17752.01 |
| Air Filter Synthetic, Wrangler [YJ] 87-95 2.5L and 4.0L NEW | 17752.03 |
| Air Filter Synthetic, Wrangler [TJ] 02-06 2.4L NEW | 17752.04 |

RUGGED RIDGE® CATBACK EXHAUST KITS FOR 2000-06 WRANGLER

Open up your Jeep's® exhaust with this great looking stainless steel catback exhaust system from Rugged Ridge®. Rugged Ridge® catback exhaust kits are manufactured from mandrel bent, T304 stainless steel that has been polished to a mirror finish. They feature a precision TIG welded muffler with reinforced inlets and outlets, and a deep throaty sound. The 2-1/4" mandrel bent pipes increase performance and provide exhaust gases a smooth exit from though looking slant cut exhaust tips. This is a bolt-on system that installs after the catalytic converter to keep you emissions legal. Dyno results show typical horsepower gains of over 10 horsepower, or you can use in conjunction with our cold air intake for even more power! Rugged Ridge® Catback Exhaust: Great Sound. Better Performance.



NEW!

| Cat-Back Exhaust System | Part # |
|---|----------|
| 00-06 4.0, 2.5L or 2.4L Wrangler, Kit, Stainless Steel NEW | 17606.71 |
| 04-06 4.0, Wrangler Unlimited, Kit, Stainless Steel NEW | 17606.72 |

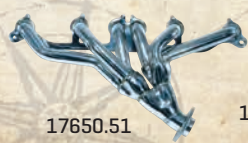

17650.51



17651.02



17660.02

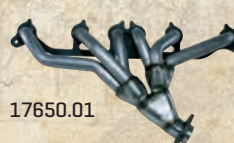

17650.01

RUGGED RIDGE® HEADERS

| Application: | Steel | Ceramic | 409 Stainless | 304 Stainless |
|-------------------------------------|----------|----------|---------------|---------------|
| 91-98 Wrangler w/ 4.0L Engine, Each | 17660.01 | 17651.01 | 17650.01 | 17650.51 |
| 99-06 Wrangler w/ 4.0L Engine, Each | 17660.02 | 17651.02 | 17650.02 | 17650.52 |

All images are subject to be representative. More detailed information is available online.

LOCKABLE SPARE TIRE MOUNT BIKE CARRIER

This easy-to-use bike rack mounts to any emergency tire mounting studs. The bike rack carries 2 bikes directly off the spare tire. It is constructed of 2" powder coated steel tubing for maximum rust protection and durability. The bike clamp features rubber pads to protect your bike's finish. The carrier comes with 2 keys for the locking mechanism. Fits wheel off sets from 2-5/8" to 6". For all Jeep® outside spare tire applications.



11237.10 Lockable Spare Tire Mount Bike Carrier

Bike Carrier

Spare Tire Mount Bike Carrier, Each

Part #

11237.10

CJ & Wrangler 76-06

11237.11 Easy Load Trail Rack



EASY LOAD TRAIL RACK

This clever application provides extra storage right above your spare tire. Carry camping gear, coolers and other necessities far above the ground. The rack tubes are welded and powder coated for extra durability. The new Euro style design makes this item look as good as it performs. You can mount this no-drill-installation rack in no time. Storage capacity is rated at 50 lbs.

Trail Rack

87-02 Wrangler, Each

Part #

11237.11

D-RING, PAIR

This heavy-duty zinc coated cast steel construction, choose from a 3/4" 9,500lb capacity or a 7/8" 13,500lb capacity to best suite your needs.



9,500lb Capacity vs. 13,500lb Capacity

D-Ring

3/4"D Ring, 9,500 lbs, Pair

Part #

11235.01

7/8"D Ring, 13,500 lbs, Pair* **NEW**

11235.03

*7/8" D-Ring requires a 1" opening to be used in a bumper mount

RECEIVER HITCH EXTENDER



Constructed from steel the extender lengthens your 2" receiver up to 12 inches! (Hitch mount accessories only - not tow rated)

Receiver Hitch Extender

12" Extender, Each **NEW**

Part #

11580.50

2" RECEIVER HITCH

Includes clip and pin. Ball not included. For Jeep® use only. 2000-lb two rating, 200-lb tongue weight rating.



Ball Mount Receiver Hitch

2" Square, Each

Part #

11237.02

RECEIVER TOW HOOK



Heavy-duty black powder coated tow hook inserts into any 2" style hitch (does not include hitch pin, not designed for towing).

Receiver Tow Hook

Fits All 2" Receivers, Each

Part #

11237.01

RECEIVER SHACKLE BRACKET



This heavy-duty steel design fits into any 2" receiver box. It is rated up to 9,500 lbs. pulling capacity on evenly distributed straight pulls. Note: never exceed your receiver capacity. Not designed for towing. Does not include hitch pin.

Receiver Shackle Bracket

All 2" Receivers, Each

Part #

11234.01

HITCH BALL

Hitch Ball includes a matching mounting nut and lock washer. Pick from two standard sizes.



Hitch Ball Kit

2" x 3/4"

Part #

11305.01

1-7/8" x 3/4"

11305.02

Designed by a dedicated team of Jeep® enthusiasts, the ORV™ suspension program is one of the most complete programs available. We have looked at each application in detail to provide the very best and most complete solution for your Jeep®. Since we focus the large majority of our attention on Jeep® vehicles, we know the ins and outs of what the best lift solution is depending on your individual needs. Below is a quick reference guide on the ORV™ program to make it easier to choose the lift you need for your particular need. Remember, all ORV™ Kits with shocks include a pair of neoprene wrapped grab handles and an Off Road Organizer for your glove box!

Welcome to ORV™ by Rugged Ridge®!

ORV™
by Rugged Ridge®



Ken W.
Katterbach, Germany



Brian H.
Lonsdale, PA



Dave G.
Flowery Branch, GA

A FEW WORDS ABOUT PRODUCT SAFETY.

Your safety and the safety of other motorists is very important. Your Jeep® is an off road capable vehicle that readily lends itself to restoration and customization. In considering modifications to your Jeep's® suspension you are the person choosing the combination of suspension, wheels, tires, drive train and accessories that best fit your intended use. Likewise, you are the person responsible for the safety and legality of the vehicle you modify. In modifying your vehicle's suspension, balance your desired off road capabilities against how the vehicle may actually be used off road and on road.

It is not practical or possible to warn about all hazards associated with your Jeep® or modifying your suspension for improved off road capabilities. Start by familiarizing yourself with all vehicle manufacturers' instructions, warnings limited warranties and the instructions and warnings accompanying your aftermarket product.

To help you make informed decisions about safety; this catalog and the instructions accompanying our products have provided certain information in the form of "Notices" and "Warnings". This information alerts you to potential hazards that could hurt you or others.

NOTICE

This is a caution against anything which may cause damage to the vehicle or its equipment if the caution is ignored. The Notice includes information about how you can avoid or reduce those risks.

WARNING

This is a signal telling you that you CAN be KILLED or SERIOUSLY HURT if you don't follow the Warning. The Warning includes information about what you must or must not do in order to reduce the risk of injury to yourself and others.

CAUTION

This is a signal telling you that you or others CAN be HURT if you don't follow the instruction. The Caution includes information about how you can avoid those risks.

WARNING HIGHER ROLLOVER RISK

Modifying the suspension of your vehicle to improve off road capabilities involves certain risks. The modified vehicle may handle differently than as factory equipped including increased ride-height; reduced lateral stability and risk of roll-over or other accident. Also, owner's choice of larger tire and wheel combinations may require additional braking force or increased stopping distances.

- Failure to drive this vehicle safely may result in serious injury or damage. Avoid sharp turns or abrupt maneuvers. Do not drive the vehicle under any speed or maneuvering conditions which may cause the vehicle to trip, roll, lose traction or compromise your ability to safely brake in an emergency.
- Familiarize yourself with all vehicle manufacturers and Rugged Ridge® warnings, instructions and limited warranties before driving this modified suspension vehicle. Follow recommended maintenance procedures and routinely inspect your vehicle components for unusual wear or off road damage.
- Rugged Ridge® does not recommend combined use of body lifts with suspension or other lift devices or modification, alteration or fabrication of any Rugged Ridge® suspension product to achieve additional lift. Also be aware that most states have restrictions on height modifications for vehicles used on road. Consult your vehicle owners manual, limited warranties, the instructions and warnings accompanying this product and state law before undertaking these modifications or using your modified suspension vehicle on road. A summary of current regulations affecting modified suspension vehicles is available from www.SEMA.org.
- Always wear seat belts and/or appropriate off road restraints, reduce your speed, tread lightly® and safely enjoy your off road vehicle.



18415.33 Poly Spacer Kit



18415.31 Coil Lift Kit



18415.20 Leaf Spring Kit

Know your Kits: Though there are many ways to provide extra lift for your Jeep®, ORV™ recommends the following lift options as the best way to Lift your Jeep®:

Poly Spacer Kits: Available for Coil Spring Jeep® Wranglers from 97-06

Coil Spring Kits: Available for Jeep® Wranglers from 97-10, 93-98 Jeep® Grand Cherokee

Leaf Spring Kits: Available for Jeep® CJ/Wrangler from 55-95

LIFT OPTIONS EXPLAINED:

• **Poly Spacer Kits** - Used for small lifts, these low cost lifts are designed for on road/light off road use only and incorporate the factory coil springs. With the addition of spacers, the ride of your Jeep® will be stiffer than original and provides very little articulation when off road. Bump stops (also called blocks) should always be a part of the kit as you will be using the factory springs. Without the bump stops your spring could over compress. These situations can cause a rebound rate that is too great causing a potential mishandling situation or damage your suspension. This method of lifting is the low cost/lower performance solution to lifting your Jeep® vehicle.

• **Coil Lift Kits** - Used for medium to large lifts, these lifts are designed for on road and moderate to severe off road use. Coil Spring kits provide the best way to give extra lift and still maintain OE ride characteristics. The 2" - 4" kits should offer new springs and extended Bump Stops as listed above as well as rear track bar bracket/brace to ensure proper centering of the axle and a secure fit. On 4" kits, it is important have front sway bar disconnects. These important disconnects will provide much more articulation when using your Jeep® off road.

• **Leaf Spring Kits** - Used for all Jeep® CJ/Wrangler vehicles from 1955-1995, these heavy-duty lifts provide a fairly straightforward lift option. The key to any leaf spring lift is the leaf spring itself and prices will vary greatly depending on quality and features. Key "must-have" features that will provide the best ride include: 1.) Teflon inserts between each leaf. These inserts allow each leaf to move independently creating a better ride both on and off road. 2.) Leaf springs should be held together with roller clips and not cinch clips. This method of securing the leaf springs together is more expensive but dramatically improves the vehicles ride and off road performance. 3.) Make sure your leaf springs have built-in degree wedges to help with pinion angle issues. Plus by having a degree wedge already attached, installation of the kit will be easier and there are no extra parts to purchase.

COIL SPRING KITS

All ORV™ springs are set to original factory rates. Provides a better ride both on and off road.



All ORV™ springs are constructed of 5160H hot rolled bar, keeps its memory so the spring will not sag.

All ORV™ coil springs are powder coated, E-coated 5/8" coil for long life and strength.

POLY SPACER KITS



Coil spring spacers are made from high density polyurethane.



Rugged Ridge® bump stops are firmer than stock stops for more suspension control.

LEAF SPRING KITS

All late model CJ/ Wrangler ORV™ leaf springs use a roller clip to improve ride.



All ORV™ leaf springs have Teflon pads in between each leaf for maximum travel and a better ride.

All ORV™ leaf springs are powder coated, shot-peened steel, reducing leaf fatigue. This treatment ensures the leaf springs will last longer.

All ORV™ leaf springs have built in degree wedges to help correct pinion angle.



All ORV™ leaf springs are pre-assembled and set to factory flex rates.

ORV™ SHOCKS

ORV™ only uses nitrogen charged gas shocks for all their kits. Though a little more money, the nitro gas shock in combination with the ORV™ kits provide a better ride both on and off road. By using an ORV™ lift kit and matching gas shocks, you optimize the suspension's capabilities giving you a better ride both on and off road. Another advantage to Nitro gas shocks is their ability to prevent body roll. This is extremely important, as body roll will kick in the ESP sensors on later model Jeeps®, which could shut the vehicle down.

ORV™ SHOCK FEATURES INCLUDE:

- 150 PSI pressurized Nitrogen gas
- Internal valving - the internal orifice will rotate when the piston moves more than 2" - automatically adjusts to make the ride as smooth as possible
- Twin tube construction to lower heat build up and protect the shock from off road obstacles
- Constructed to ORV™ specifications by a leading Shock manufacturer
- Bonded Iron 14mm piston with extra chroming - provides for a longer, rust free life
- Includes polyurethane bushings and a black shock boot
- Limited lifetime warranty on the shocks

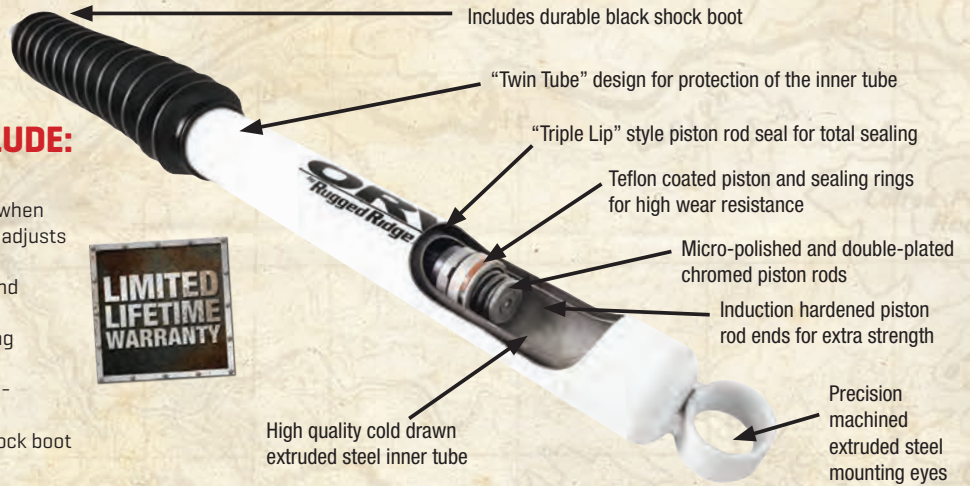

| ORV™ Shocks | Front | Extended | Collapsed | Rear | Extended | Collapsed |
|---|----------|----------|-----------|----------|----------|-----------|
| ORV™ Nitrogen Series Shock, 97-06 Jeep® Wrangler, 2" Lift, 04-06 Wrangler Unlimited 2" Lift | 18465.05 | 22.75" | 13.54" | 18465.06 | 22.58" | 13.71" |
| ORV™ Nitrogen Series Shock, 97-06 Jeep® Wrangler, 4" Lift, 04-06 Wrangler Unlimited 4" Lift | 18465.07 | 24.75" | 14.54" | 18465.08 | 24.84" | 14.82" |
| ORV™ Nitrogen Series Shock, 87-95 Jeep® Wrangler, 4" Lift | 18465.03 | 28.75" | 16.56" | 18465.04 | 24.84" | 14.82" |
| ORV™ Nitrogen Series Shock, 87-95 Jeep® Wrangler, 2.5" Lift | 18465.09 | 22.75" | 13.54" | 18465.02 | 22.58" | 13.71" |
| ORV™ Nitrogen Series Shock, 76-86 Jeep® CJ, 2" Lift | 18465.14 | 19.07" | 12.07" | 18465.02 | 22.58" | 13.71" |
| ORV™ Nitrogen Series Shock, 76-86 Jeep® CJ, 4" Lift | 18465.02 | 22.58" | 13.71" | 18465.01 | 24.84" | 14.82" |
| ORV™ Nitrogen Series Shock, 55-75 Jeep® CJ, 4" Lift | 18465.01 | 24.84" | 14.82" | 18465.01 | 24.84" | 14.82" |



COLORED SHOCK BOOTS

Add a splash of color to your rig with colored shocks boots from Rugged Ridge®. These durable shock boots keep mud and debris from prematurely ruining your shocks and they look great too! Works on ORV Nitrogen Shocks and most other brands as well! Sold each.

| Shock Boots | Part# |
|--|----------|
| Shock Boot, Black, ORV™ Suspension, Universal Application NEW | 18479.50 |
| Shock Boot, Red, ORV™ Suspension, Universal Application NEW | 18479.51 |
| Shock Boot, Blue, ORV™ Suspension, Universal Application NEW | 18479.52 |

| ORV™ Steering Stabilizers | Part# |
|---|----------|
| ORV™ Hydraulic Series Steering Stabilizer, 97-06 Jeep® Wrangler | 18475.02 |
| ORV™ Hydraulic Series Steering Stabilizer, 04-06 Jeep® Wrangler Unlimited | 18475.02 |
| ORV™ Hydraulic Series Steering Stabilizer, 87-95 Jeep® Wrangler | 18475.02 |
| ORV™ Hydraulic Series Steering Stabilizer, 55-86 Jeep® CJ | 18475.01 |

ORV™ STEERING STABILIZERS

ORV™ recommends upgrading your current steering stabilizer or adding a stabilizer on all lifted Jeep® vehicles. The ORV™ Steering stabilizer dampens out the roughness of the highway and the vibration from running larger tires and wheels. ORV™ Hydraulic Stabilizers also make it easier to move those larger tires and wheels both on and off road. These noticeable handling improvements are well worth the small investment!



What to Buy:

When looking at which kit is best for your application you need to determine two important things: size of tire and use of vehicle. On the 97-06 Wrangler TJ, 2" spacer lifts are designed for a larger tire than factory and light off road use. The 2" coil kit is designed for a larger tire and moderate off road use. The 4" coil kit is designed for more severe off road use and up to a 34" x 12.5" x 15" tire.

ORV™ COIL SPRING LIFT KITS FEATURE:

- Get off road performance while not sacrificing on road ride! This kit will provide as close to factory a ride as you can get while providing off road articulation.
- Includes four powder coated, E-coated 5160H hot rolled bar, 5/8" coil springs that are set to original factory rates. By using 5160H hot rolled bar, ORV™ springs keep their memory eliminating any possibility of future sag.
- By setting the coil springs to factory rates, you get the best on road ride possible and the ability to use a larger tire.
- ORV™ uses tough, over built extended control arms for added strength and higher performance. Each arm has a beefy 3/16" wall thickness and each end is tapered before welding: this extra heavy-duty design ensures a long life, both on and off road.
- In most cases control arms are longer than factory to adjust for caster. This is not always true for other brand lifts! Each arm bushing can be easily greased without removing the arm from the vehicle.
- Each 2" Coil Spring Lift Kit includes 1" transfer case lowering brackets. These are not spacers but full-length brackets that actually solidly secure your transfer case. ORV uses these brackets rather than spacers as spacers can create flex therefore putting undue stress on the drive line.
- Each 4" Coil Spring Lift Kit includes 1.5" transfer case lowering brackets. These are not spacers but full length brackets that actually "true" your transfer case. ORV™ uses these brackets rather than spacers, as spacers can create flex therefore putting undue stress on the drive line.
- Kit includes two sway bar disconnects for more off road articulation.
- Due to the changed pinion angle, we highly recommend a new drive shaft and a slip yoke eliminator kit be installed when using any 4" or greater lift kit on a 1997-2006 Wrangler/Unlimited.
- All 4" Kits will require the purchase of a drop pitman arm to ensure proper steering geometry (sold separately).

CJ & Wrangler 76-06



ORV™ 2" Poly Spacer for 1997-2006 Wrangler 18415.33
 • Low cost kit that provides a small lift for over sized tires
 • Each kit contains 4 spacers and four bump stops
 • Spacers are made of durable polyurethane for a long life



2" Lift for 2003-06 Wrangler/Rubicon 18415.32

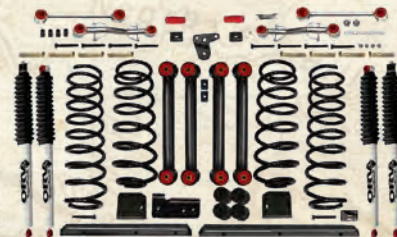

4" Lift for 2003-06 Wrangler/Rubicon 18415.42

| | Kit w/o Shocks | Kit w/ Shocks | Max Tire Size HxWxD | Max Wheel Offset | Est. Install Time |
|---|----------------|---------------|---------------------|------------------|-------------------|
| 97-06 Wrangler, 04-06 Wrangler Unlimited | | | | | |
| 2" Poly Spacer (4) Lift, 97-06 Wrangler | 18401.33 | 18415.33 | 32"x11.5"x15" | 3.75" | 4 Hrs. |
| 2" Lift, 97-02 Wrangler | 18401.30 | 18415.30 | 32"x11.5"x15" | 3.75" | 6 Hrs. |
| 2" Lift, 03-06 Wrangler/Rubicon | 18401.31 | 18415.31 | 32"x11.5"x15" | 3.75" | 6 Hrs. |
| 2" Lift, 04-06 Wrangler Unlimited/Rubicon | 18401.32 | 18415.32 | 32"x11.5"x15" | 3.75" | 6 Hrs. |
| 4" Lift, 97-02 Wrangler* | 18401.40 | 18415.40 | 34"x12.5"x15" | 3.75" | 6 Hrs. |
| 4" Lift, 03-06 Wrangler/Rubicon* | 18401.41 | 18415.41 | 34"x12.5"x15" | 3.75" | 6 Hrs. |
| 4" Lift, 04-06 Wrangler Unlimited/Rubicon* | 18401.42 | 18415.42 | 34"x12.5"x15" | 3.75" | 6 Hrs. |

* Will require a drop pitman arm. Sold separately.

18401.30 Kit includes: (4) coil springs, (4) lower links, track bar relocation bracket, (3) transfer case lowering brackets, hardware kits

18401.40 Kit includes: (4) coil springs, (4) lower links, track bar relocation bracket, (2) transfer case lowering brackets, (2) transmission lowering brackets, hardware kits

18401.31/.32 Kit includes: (4) coil springs, (4) lower links, track bar relocation bracket, (2) transfer case lowering brackets, (2) transmission lowering brackets, hardware kits

18401.41/.42 Kit includes: (4) coil springs, (2) lower front links, (2) lower rear links, (2) rear bump stop brackets, rear track bar relocation bracket, front double disconnect link, rear sway bar end links, (2) transfer case lowering brackets, (2) transmission lowering brackets, hardware kits.

CV EQUIPPED DRIVE SHAFTS FOR 87-06 WRANGLERS



16592.05

| CV Equipped Rear Drive Shafts | Part # |
|--|----------|
| 88-93 Wrangler with up to 3" Lift | 16592.01 |
| 88-93 Wrangler with over 3" Lift | 16592.02 |
| 94-95 Wrangler with up to 3" Lift | 16592.03 |
| 94-95 Wrangler with over to 3" Lift | 16592.04 |
| 97-06 Wrangler with 2"-6" Lift | 16592.05 |
| 97-06 Wrangler with 3.5"-6" Lift [for Mega Short SYE only] | 16592.06 |

*These drives shafts use 3-5/8" wide U-Joints, please verify U-Joint size before ordering.

DROP PITMAN ARMS

Lifting a vehicle takes more than just slapping on taller springs. The stock steering linkage is designed for use with the stock height suspension. The steering linkage angles of a lifted vehicle are more extreme and influenced by suspension travel. This drop pitman arm helps reduce the angle of your drag link and reduce bumpsteer created when a suspension lift is installed.



| Drop Pitman Arms | Part # |
|--|----------|
| 87-06 Wrangler w/Power Steering, 4" of Lift | 18006.50 |
| 87-06 Wrangler w/Manual Steering, 4" of Lift | 18006.52 |
| 76-86 CJ w/Power Steering, 4" of Lift | 18006.51 |
| 76-86 CJ w/Manual Steering, 4" of Lift | 18006.53 |
| 72-75 CJ w/Power Steering, 4" of Lift | 18006.57 |

WARNING: WARNING: Look at the beginning of the ORV™ section for important safety information.

BODY LIFTS FOR 1997-06 WRANGLER

Need some extra clearance for your oversized tires? This all new Rugged Ridge® body lift includes everything you need to fit up to 33" diameter tires. By allowing a taller tire you'll get that extra ground clearance you need when facing off road obstacles.

| 3" Body Lift | Part # |
|---|----------|
| 97-06 Wrangler w/ auto, 05-06 6-speed transmission, Kit | 18303.11 |
| 97-04 Wrangler w/ 5-speed, Kit | 18303.10 |



WARNING
 HIGHER ROLL-OVER RISK
 Rugged Ridge® does not recommend combined use of body lifts with suspension or other lift devices or modification, alteration or fabrication of any Rugged Ridge® product to achieve additional lift. See additional product safety information and (WARNING) on page 76.

1955-95 CJ/WRANGLER

What to Buy:

When looking at which kit is best for your application you need to determine two important things: size of tire and use of vehicle. On the 1976-95 CJ/Wrangler, the 2" - 2.5" Leaf Spring kits are designed for a tire size up to 31" and moderate off road use. The 1955-95 CJ/Wrangler 4" Leaf Spring kits are designed for more severe off road use and up to a 33" x 12.5" x 15" tire.



18415.08



18401.20

WARNING: WARNING: Look at the beginning of the ORV™ section for important safety information.

ORV™ Leaf Spring Lift for 1955-1995 CJ / Wrangler

- Get off road performance without sacrificing on road ride! These kits provide as close to a factory ride as possible.
- Includes 4 powder coated, shot-peened leaf springs with Teflon inserts and pre-installed degree wedges.
- Each leaf spring has Teflon between each leaf for a factory ride, better performance.
- Pre-installed degree wedges provide ease of installation and no more parts to buy. These wedges help to correct any pinion angle issues that may arise due to the lift.
- By shot-peening the leaves before assembly, it assures that the leaf springs will not sag over time.
- All ORV™ U-bolts are grade-8 and E-coated to ensure they will be able to take off road abuse.
- Due to the changed pinion angle, we highly recommend a new drive shaft and a slip yoke eliminator kit be installed when using any 4" or greater lift kit on a 87-95 Wrangler [see below].
- All 4" Kits will require the purchase of a drop pitman arm to ensure proper steering geometry [sold separately, see below].
- Note: Actual lift height is dependent on specific Jeep® characteristics and additional parts being put on the vehicle [bumpers, winch, hard tops, soft tops etc.].

| Application | Kit w/o Shocks | Kit w/ Shocks | Max Tire Size-HxWxD | Max Wheel Offset | Est. Install Time |
|-----------------------------------|----------------|---------------|---------------------|------------------|-------------------|
| 87-95 Wrangler, 2"-2.5" Lift | 18401.20 | 18415.20 | 31"x10.5"x15" | 3.75" | 4 Hrs. |
| 87-95 Wrangler, 4" Lift* | 18401.25 | 18415.25 | 33"x12.5"x15" | 3.75" | 6 Hrs. |
| 76-86 CJ5, CJ7, CJ8, 2"-2.5" Lift | 18401.08 | 18415.08 | 31"x12.5"x15" | 3.75" | 4 Hrs. |
| 76-86 CJ5, CJ7, CJ8, 4" Lift* | 18401.15 | 18415.15 | 33"x12.5"x15" | 3.75" | 4 Hrs. |
| 55-75 CJ5, CJ6, 4" Lift* | 18401.14 | 18415.14 | 33"x12.5"x15" | 3.75" | 4 Hrs. |

* 72-76 models will require a drop pitman arm. Sold separately. [See page C60]

* 87-95 Wrangler 4" Lift Kits require the use of a CV Driveshaft [page C60] and Slip Yoke Eliminator [C48]. Sold Separately.

18401.20 Kit includes: [4] leaf springs, [8] U-bolts, hardware kits.

18401.25 Kit includes: [4] leaf springs, [8] U-bolts, hardware kits, [2] track bar extension brackets.

18401.08/.15 Kit includes: [4] leaf springs, [8] U-bolts, hardware kits.

18401.14 Kit includes: [4] leaf springs, [8] U-bolts, hardware kits.

Centering Pin

| | Part # |
|--|----------|
| Leaf Spring, ORV Suspension, Shaft Diameter: 5/16-in. Length 50mm NEW | 18382.01 |
| Pair, Leaf Spring, ORV Suspension, Shaft Diameter: 5/16-in. Length 50mm NEW | 18382.50 |



18265.12

Heavy Duty Shackle Kits

| | Part# |
|---|----------|
| 1959-1975 CJ5, 1959-1975 CJ6, Shackle Kit, Without Bushings, Front or Rear, Heavy Duty | 18265.01 |
| 1959-1975 CJ5, 1959-1975 CJ6, Shackle Kit, Without Bushings, Front or Rear, Heavy Duty | 18265.02 |
| 1959-1975 CJ5, 1959-1975 CJ6, Shackle Kit, Black Bushings, Front or Rear, Heavy Duty | 18265.03 |
| 1959-1975 CJ5, 1959-1975 CJ6, Shackle Kit, Red Bushings, Front or Rear, Heavy Duty | 18265.04 |
| 1976-1983 CJ5, 1976-1986 CJ7, 1981-1986 CJ8, Shackle Kit, Without Bushings, Front, Heavy Duty | 18265.05 |
| 1976-1983 CJ5, 1976-1986 CJ7, 1981-1986 CJ8, Shackle Kit, Without Bushings, Rear, Heavy Duty | 18265.09 |
| 1976-1983 CJ5, 1976-1986 CJ7, 1981-1986 CJ8, Shackle Kit [Greasable], Without Bushings, Front, Heavy Duty | 18265.06 |
| 1976-1983 CJ5, 1976-1986 CJ7, 1981-1986 CJ8, Shackle Kit [Greasable], Without Bushings, Rear, Heavy Duty | 18265.10 |
| 1976-1983 CJ5, 1976-1986 CJ7, 1981-1986 CJ8, Shackle Kit [Greasable], Black Bushings, Front, Heavy Duty | 18265.07 |
| 1976-1983 CJ5, 1976-1986 CJ7, 1981-1986 CJ8, Shackle Kit [Greasable], Black Bushings, Rear, Heavy Duty | 18265.11 |
| 1976-1983 CJ5, 1976-1986 CJ7, 1981-1986 CJ8, Shackle Kit [Greasable], Red Bushings, Front, Heavy Duty | 18265.08 |
| 1976-1983 CJ5, 1976-1986 CJ7, 1981-1986 CJ8, Shackle Kit [Greasable], Red Bushings, Rear, Heavy Duty | 18265.12 |
| 1987-1995 Wrangler, Shackle Kit, Without Bushings, Front, Heavy Duty* | 18265.13 |
| 1987-1995 Wrangler, Shackle Kit, Without Bushings, Rear, Heavy Duty* | 18265.17 |
| 1987-1995 Wrangler, Shackle Kit [Greasable], Without Bushings, Front, Heavy Duty* | 18265.14 |
| 1987-1995 Wrangler, Shackle Kit [Greasable], Without Bushings, Rear, Heavy Duty* | 18265.18 |
| 1987-1995 Wrangler, Shackle Kit [Greasable], Black Bushings, Front, Heavy Duty* | 18265.15 |
| 1987-1995 Wrangler, Shackle Kit [Greasable], Black Bushings, Rear, Heavy Duty* | 18265.19 |
| 1987-1995 Wrangler, Shackle Kit [Greasable], Red Bushings, Front, Heavy Duty* | 18265.16 |
| 1987-1995 Wrangler, Shackle Kit [Greasable], Red Bushings, Rear, Heavy Duty* | 18265.20 |

* These shackles provide 1" lift over OE shackles.

UNIVERSAL LEAF SPRING PERCH

- Replacement for collapsed perches
- Allows for relocation of leaf springs or change to wider springs
- Weld-on installation



18267.01

| Universal Leaf Spring Perch | Axle | |
|---|-------------|----------|
| | Tube Radius | Part # |
| Universal Spring Perch, Pair NEW | 1.75" Wide | 18267.01 |
| Universal Spring Perch, Pair NEW | 2" Wide | 18267.02 |
| Universal Spring Perch, Pair NEW | 2.5" Wide | 18267.03 |
| Universal Spring Perch, Pair NEW | 3" Wide | 18267.04 |

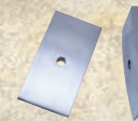

DEGREE WEDGES

Degree wedges are used to correct pinion angle and reduce driveline vibration on lifted leaf spring equipped vehicles.

| Degree Wedges, 76-86 CJ, 87-95 YJ | Part # |
|---|----------|
| Cast Aluminum Wedge, Pair [for 6° pinion angle] | 18206.01 |
| Cast Aluminum Wedge, Pair [for 8° pinion angle] | 18206.02 |

POLYURETHANE/SUSPENSION ACCESSORIES



1-2003

COMPLETE POLYURETHANE KIT

[includes all major suspension points for steel bodied models. Not for fiberglass bodies]:

| Description | Poly # | Replaced by Omix # |
|----------------|--------|--------------------|
| 59-75 CJ | 1-2001 | 18350.01 |
| 76-79 CJS, CJ7 | 1-2002 | 18350.02 |
| 80-86 CJS, CJ7 | 1-2003 | 18350.03 |
| 87-95 Wrangler | 1-2005 | 18350.05 |
| 97-06 Wrangler | 1-2006 | 18350.06 |

FRONT SPRING & SHACKLE BUSHING KITS:

| Description | Poly # | Replaced by Omix # |
|----------------|--------|--------------------|
| 59-75 CJ | 1-1001 | 18364.01 |
| 76-86 CJ | 1-1002 | 18364.02 |
| 87-95 Wrangler | 1-1005 | 18364.03 |

REAR SPRING & SHACKLE BUSHING KITS:

| Description | Poly # | Replaced by Omix # |
|----------------|--------|--------------------|
| 59-75 CJ | 1-1001 | 18364.01 |
| 76-86 CJ | 1-1003 | 18365.01 |
| 87-95 Wrangler | 1-1005 | 18364.03 |



1-1002

SHACKLE BUSHING KITS:

| Description | Poly # | Replaced by Omix # |
|--|--------|--------------------|
| 59-75 CJ, Front Or Rear [Need 2] | 1-805 | 18366.05 |
| 76-86 CJ Front | 1-801 | 18366.01 |
| 76-86 CJ Rear | 1-802 | 18366.02 |
| 87-95 Wrangler, Front Or Rear [Need 2] | 1-803 | 18366.03 |

SWAYBAR BUSHING KITS:

| Description | Poly # | Replaced by Omix # |
|---|--------|--------------------|
| 76-86 CJ With 15/16" Diameter Bar, Front | 1-1101 | 18367.01 |
| 76-86 CJ With 7/8" Diameter Bar, Front | 1-1110 | 18367.10 |
| 87-95 Wrangler With 1 1/8" Diameter Bar, Front | 1-1107 | 18367.07 |
| 87-95 Wrangler With 15/16" Diameter Bar, Front | 1-1102 | 18367.02 |
| 97-06 Wrangler With 30.5 Mm Diameter Bar, Front | 1-1111 | 18367.11 |
| 97-06 Wrangler With 13Mm Diameter Bar, Rear | 1-1112 | 18367.12 |



POLYURETHANE BUSHINGS/STAINLESS BRAKE HOSES

TRACK ARM BUSHING KITS:

| Description | Poly # | Replaced by Omix # |
|--|--------|--------------------|
| 87-95 Wrangler, Front Or Rear [Need 2] | 1-1202 | 18368.01 |
| 97-06 Wrangler, Front | 1-1205 | 18368.04 |
| 97-06 Wrangler, Rear | 1-1206 | 18368.05 |



1-1205

CONTROL ARM BUSHING KITS:

| | | |
|--------------------------------------|-------|----------|
| 97-06 Wrangler, Upper & Lower, Front | 1-204 | 18362.03 |
|--------------------------------------|-------|----------|



1-1204

COIL SPRING INSULATORS:

| | | |
|----------------------|--------|----------|
| 97-06 Wrangler, Pair | 1-1701 | 18369.04 |
|----------------------|--------|----------|



1-1701

COIL SPRING SPACER:

| | | |
|--|---|----------|
| 97-06 Wrangler, 2" Lift, Each NEW | - | 18369.08 |
|--|---|----------|

BODY MOUNT BUSHING SETS:

| | | |
|-------------------------|-------|----------|
| 55-71 CJ [14 PCS] | 1-101 | 18351.01 |
| 72-75 CJ [18 PCS] | 1-109 | 18351.07 |
| 76-79 CJ5, CJ7 [22 PCS] | 1-102 | 18351.02 |
| 80-86 CJ5, CJ7 [22 PCS] | 1-103 | 18351.03 |
| 81-86 CJ8 [26 PCS] | 1-104 | 18351.04 |
| 87-95 Wrangler [22 PCS] | 1-105 | 18351.05 |
| 97-06 Wrangler [22 PCS] | 1-107 | 18351.06 |

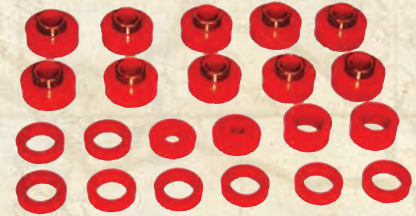

1-103



1-1301

1-1901

19-1712

1-501

7-1604

1-1201

MISC. POLYURETHANE ITEMS:

| Description | Poly # | Replaced by Omix # |
|---|----------|--------------------|
| 76-95 CJ & Wrangler Axle Snubber Pair | 1-1301 | 18369.03 |
| 76-86 CJ 6 Cyl Complete Drive Train Kit | 1-1901 | 18390.50 |
| 45-95 CJ & Wrangler, Tie Rod Boots | 19-1712 | 18369.02 |
| 72-86 CJ 6 Cyl Engine Mount Pair | 1-501 | 18390.01 |
| 87-06 Wrangler 6-Cyl Engine Mount Pair | 1-502 | 18390.02 |
| 72-81 CJ 5.0L AMC Engine Mount Pair | 1-503 | 18390.03 |
| 73-95 CJ & Wrangler Trans. Mount, Red | 7-1604 | 18392.01 |
| 73-95 CJ & Wrangler Trans. Mount, Black | 7-1604BL | 18608.04 |
| 97-06 Wrangler Trans. Mount | 1-1601 | 18391.01 |
| 72-95 CJ & Wrangler Trans. Torque Arm Bushing Pair | 1-1201 | 18369.01 |
| Jack Handle Grabber (Anti-rattle), All Hi Lift Style Jacks NEW | 19-1404 | 18369.50 |
| 97-06 Wrangler, Sway Bar Disconnect Eye Bushing NEW | - | 18366.80 |
| Shock Bushing, Rubber, Universal Application, 1-7/16 Long, 5/8 Id, 1-In OD NEW | - | 18367.20 |

FRONT & REAR BRAIDED STAINLESS STEEL BRAKE HOSES:

(PROVIDES UP TO 4" EXTRA LENGTH. ESSENTIAL FOR LIFTED VEHICLES)

| Description | Part # |
|------------------------------------|----------|
| 55-71 CJ w/ Drum Brakes Front Pair | 16734.01 |
| 72-73 CJ w/ Drum Brakes Front Pair | 16734.02 |
| 74-75 CJ w/ Drum Brakes Front Pair | 16734.03 |
| 76-78 CJ w/ Drum Brakes Front Pair | 16734.04 |
| 76-81 CJ w/ Disc Brakes Front Pair | 16734.05 |
| 82-86 CJ w/ Disc Brakes Front Pair | 16734.06 |
| 87-95 Wrangler Front Pair | 16734.07 |
| 97-06 Wrangler Front Pair | 16734.08 |



| Description | Part # |
|----------------------------|----------|
| 55-86 CJ Rear Single | 16735.01 |
| 67-73 CJ Single, Rear | 16735.02 |
| 74-75 CJ Single, Rear | 16735.03 |
| 76-86 CJ Single, Rear | 16735.04 |
| 87-95 Wrangler Rear Single | 16735.05 |
| 97-06 Wrangler Rear Single | 16735.06 |

ORV™ SUSPENSION SYSTEMS BY RUGGED RIDGE® LIMITED LIFETIME WARRANTY

Your Omix-Ada® /Rugged Ridge® product is covered by the Lifetime Limited Warranty explained below that gives you specific legal rights. This limited warranty is the only warranty Omix-Ada® /Rugged Ridge® /ORV™ makes in connection with your product purchase. Parts sold by Omix-Ada® or Rugged Ridge® but supplied by other vendors are exclusively warranted by the vendor supplying the part. Omix-Ada® neither assumes nor authorizes any vendor, retailer or other person or entity to assume for it any other obligation or liability in connection with this product or Limited Warranty.

What is covered? Subject to the terms, exclusions and limitations herein and with respect only to products first sold in the United States, Omix-Ada® warrants to the initial retail purchaser only that its Rugged Ridge® suspension kits, and ORV™ shocks and stabilizers shall be free of defects in material and workmanship for so long as the initial retail purchaser owns the vehicle on which these products were originally installed. All other express or implied warranties are hereby disclaimed. Your warrantor for these parts is Omix-Ada®, Inc., 460 Horizon Dr., Suite 400 Suwanee, GA 30024. Omix-Ada® reserves the rights to: [a.] require proof of purchase as a condition of this Limited Warranty, [b.] make future revisions to its Limited Warranty without prior notice.

What is not covered? Your Omix-Ada® /Rugged Ridge® /ORV™ Limited Warranty does not cover any Rugged Ridge® /ORV™ suspension systems that are used or combined with non-ORV™ suspension components. Furthermore, ORV™ suspensions not installed with ORV™ or other recommended shock absorbers may void the Limited Warranty. Products that wear out or fail due to the use of larger tires or wheels are not covered by this Limited Warranty. Your Omix-Ada® Limited Warranty further does not cover products or parts supplied to Omix-Ada® by outside vendors or products, parts or vehicles Omix-Ada® determines to have been damaged by or subjected to: Installation damage, alteration, modification or failure to maintain.

- Normal wear and tear [bushings, tie-rod ends, etc.]. Scratches or defects in product finishes [powder coating, plating, etc.] or damage due to shipping.
- Damage arising or related to non- Omix-Ada® /Rugged Ridge® /ORV™, including but not limited to any vehicle's electronic stability system, related components or other vehicle systems.
- Racing or other vehicle competitions or contests. Accidents, impact by rocks, trees, obstacles or other aspects of the environment.
- Theft, vandalism or other intentional damage.
- Products used in application other than those recommended in the current /Rugged Ridge® /ORV™ catalog or the instructions accompanying your Rugged Ridge® /ORV™ product.

Remedy Limited to Repair / Replacement. The exclusive remedy provided hereunder shall, upon Omix-Ada® inspection and at Omix-Ada's® option, be either repair or replacement of product or parts covered under this Limited Warranty. Customers requesting warranty consideration on Omix-Ada® branded parts (including Rugged Ridge® and ORV™) should first contact the independent distributor from whom you purchased your part to obtain a Returned Goods Authorization number. All removal, shipping and installation costs are customer's responsibility. Customers requesting warranty consideration on non-Omix-Ada® branded parts should refer to the manufacturers' Limited Warranty and contact them directly. If a replacement part is needed before the Omix-Ada® part can be returned, you must first purchase the replacement part. Then, if Omix-Ada® deems the part warrantable, you will be credited the purchase price.

Other Limitations - Exclusion of Damages - Your Rights Under State Law

- In consideration of the purchase price paid, neither Omix-Ada® nor any independent Omix-Ada® distributor/licensee are responsible for any time loss, rental costs, or for any incidental, consequential, punitive or other damages you may have or incur in connection with any part or product purchased. Your exclusive remedy hereunder for covered parts is repair/replacement as described above.
- This Limited Warranty gives you specific rights. You may also have other rights that vary from state to state. For example, while all implied warranties are disclaimed herein, any implied warranty required by law is limited to the terms of Limited Warranty described above. Some states do not allow limitations of how long an implied warranty lasts and /or do not allow the exclusion or limitation of incidental or consequential damages, so the limitations and exclusions herein may not apply to you.





DRIVETRAIN ENGINEERING PERFECTED

Are you looking for an axle or ring and pinion rugged enough to match your off the beaten path sense of adventure? Alloy USA® axle shafts and Precision Gear® ring & pinions have been propelling muscle cars, trucks and four wheel drive vehicles down highways, drag strips, back roads and over the world's roughest terrain for nearly a decade. With the recent asset and intellectual property purchase of Alloy USA® and Precision Gear® by Ultra Axle LLC, an affiliate of Omix-Ada® Inc., these two brands are now backed by an

industry leading, financially strong company that will be there for you in the long haul. As a member of the Omix-Ada® group of companies Alloy USA® and Precision Gear® will provide the service and support you demand!

The dedicated team of Alloy USA® and Precision Gear® engineers have developed, tested, raced and trail ridden each of our products until they were perfected. We marry the mechanics of engineering with the art of manufacturing to produce the finest in drivetrain solutions. High tensile strength 4340 Chromoly is heat-treated, tempered and induction hardened to produce these heavy-duty axles that are up to 40% stronger than stock. We use the latest splining technology to produce splines that are stronger than traditional cut splines. The shafts are then precision CNC machined and magnaflux inspected for cracks before receiving the Alloy USA® logo and a slick black anodized or natural finish.

Why have we put so much time and energy into developing our Axle Shafts and Ring & Pinions? Because horsepower is useless if you can't get it to the ground. We take pride in engineering solutions and prove it by backing each product with an industry leading warranty. Each axle is covered by our exclusive 10-year limited warranty and each ring and pinion is covered by a 5-year limited warranty so you can drive with confidence!

THE BEST WARRANTY IN THE BUSINESS

Alloy USA®/Precision Gear® Limited Warranty

Your Alloy USA® or Precision Gear® product is covered by the Limited Warranty explained below that gives you specific legal rights. This limited warranty is the only warranty Ultra Axle® LLC [the distributor/warrantor of these products] makes in connection with your purchase. Ultra Axle® LLC neither assumes nor authorizes any vendor, retailer or other person or entity to assume for it any other obligation or liability in connection with its products or Limited Warranty.

What is covered? Subject to the terms, exclusions and limitations herein and with respect only to products first sold in the United States, Ultra Axle® LLC warrants to the initial retail purchaser only that products sold under its Alloy USA® and Precision Gear® trademarks including Axle Shafts, Ring and Pinions, Installation Kits, Jeep® Overhaul Kits, Alloy USA® X Joints and Differential Covers shall be free of defects in material and workmanship for the Limited Warranty term/duration described below. This Limited Warranty shall be measured from the date of initial retail purchase, extends only to the initial retail purchaser and is not transferable. All other express or implied warranties are hereby disclaimed. Your warrantor for these parts is Ultra Axle® LLC, 460 Horizon Dr., Suite 400 Suwanee, GA 30024 [770-614-6101]. Ultra Axle® reserves the right to: [a.] require proof of purchase as a condition of this Limited Warranty, [b.] make future revisions to its Limited Warranty without prior notice.

Duration of Limited Warranty by Product Line

Alloy USA®, front and rear axles- **10 Year Limited Warranty**

Precision Gear® and Alloy USA® Ring and Pinions- **5 Year Limited Warranty**

Jeep® Overhaul kits, Alloy USA® X Joints, Tube Seals, Differential Covers, Differential Cable Lock Kits, Wheel Spacers, Transfer Chain Kits, Yoke Conversion Kits & Hub Conversion Components - **3 Year Limited Warranty**

What is not covered: Your Alloy USA®, Precision Gear® Limited Warranty does not cover damage or claims to any component, vehicle or person other than Alloy USA® or Precision Gear® parts purchased by the initial retail purchaser. Your Alloy USA®, Precision Gear® Limited Warranty does not cover damage or claims to any component, vehicle or person Ultra Axle® LLC determines to have been damaged by or subjected to:

- Installation damage, alteration, modification, misuse or failure to maintain.
- Products used in application other than those recommended in the current Alloy USA®/Precision Gear® catalog or the instructions accompanying your Alloy USA® Precision Gear® product.
- Normal wear and tear/product life deterioration, scratches or defects in product finishes [powder coating, plating, etc.] or damage due to shipping.
- Damage arising or related to non- Ultra Axle® LLC products including but not limited to any vehicle's electronic stability system, related components or other vehicle systems.
- Accidents, impact by rocks, trees, obstacles or other aspects of the use environment.
- Theft, vandalism or other intentional damage.

Remedy Limited to Repair / Replacement. The exclusive remedy provided hereunder shall, upon Ultra Axle® LLC inspection and at Ultra Axle® LLC option, be either repair or replacement of the Ultra Axle® LLC parts covered under this Limited Warranty. Customers requesting warranty consideration should first contact the independent distributor selling your part to obtain a Returned Goods Authorization number. All removal, shipping and installation costs are customer's responsibility. If a replacement part is needed before the Ultra Axle® LLC part can be returned, you must first purchase the replacement part. Then, if Ultra Axle® LLC determines the part warrantable, you will be credited the purchase price of that part.

Other Limitations - Exclusion of Damages - Your Rights Under State Law

- In consideration of the purchase price paid, neither Ultra Axle® LLC nor any independent distributor are responsible for any loss of use or time, rental costs, or for any incidental, consequential, punitive or other damages you may have or incur in connection with your vehicle or any Ultra Axle® LLC product. Your exclusive remedy for Ultra Axle® LLC parts covered hereunder is repair/replacement as described above.
- This Limited Warranty gives you specific rights. You may also have other rights that vary from state to state. For example, while all implied warranties are disclaimed herein, any implied warranty required by law is limited to the duration and other enforceable terms of Limited Warranty described above. Some states do not allow limitations of how long an implied warranty lasts and /or do not allow the exclusion or limitation of incidental or consequential damages, so the limitations and exclusions herein may not apply to you.

© Ultra Axle® LLC Axle LLC. 1.3.2010. All Rights Reserved. Jeep® is a registered trademark of Chrysler LLC. Ultra Axle® LLC is an independent aftermarket vendor not affiliated with any vehicle manufacturer. Pro Gear® and Ultraite® Gears and Differentials® are additional trademarks of Ultra Axle® LLC.



Chrysler®, Chevrolet®, Dodge®, GM®, Ford®, Jeep®, International® & other names used here are trademarks of their respective owners and are used within this publication for identification purposes only. Alloy USA® is not affiliated with these companies. The information in this catalog is believed to be correct at the time of publishing. The publisher is not responsible for any losses, direct or indirect, that are the result of any information within this publication. Alloy USA® and Precision Gear® and their corresponding logos are trademarks of Ultra Axle®, LLC. OMIX-ADA® and its corresponding logo are registered trademarks of OMIX-ADA®, Inc.

®Registered 2010, Ultra Axle®, LLC. all rights reserved.

FRONT AXLE KITS

High tensile strength 4340 Chromoly is heat-treated, tempered and induction hardened to produce these heavy-duty axles that are up to 40% stronger than stock 1040 axles. Each axle shaft is backed by Alloy USA®'s exclusive ten-year warranty! We use the latest splining technology to produce splines that are stronger than traditional cut splines. The shafts are then precision CNC machined and magnaflux inspected for cracks before receiving a slick black anodized finish. Our front axle shaft kits include everything you need to complete the job: both passenger and driver inner and outer axle shafts, seals, U-joints and clips.



JEEP® COMPLETE INNERS/OUTERS WITH U-JOINTS & CLIPS

| Application | Part # | Inner | Outer | Axle |
|---|-----------|-------|-------|------|
| Jeep® CJ5 72-83, CJ7 & CJ8 76-81, Dana 30 Grande 30-Spline Kit [Narrow-Trac Kit] ³ | 12129 | 30 | 27 | D30 |
| Jeep® CJ5 72-83, CJ7 & CJ8 76-81, Dana 30 Grande 30-Spline Kit With ARB Locker [Narrow-Trac Kit], 3.73 & Up | 12129-ARB | 30 | 27 | D30 |
| Jeep® CJ5.72-83, CJ7 & CJ8 76-81, Dana 30 27-Spline Kit [Narrow-Trac Kit] | 12139 | 27 | 27 | D30 |
| Jeep® CJ7 & CJ8, 82-86, Dana 30 Grande 30-Spline Kit [Wide-Trac Kit] ³ | 12130 | 30 | 27 | D30 |
| Jeep® CJ7 & CJ8, 82-86, Dana 30 Grande 30-Spline Kit With ARB Locker [Wide-Trac Kit], 3.73 & Up | 12130-ARB | 30 | 27 | D30 |
| Jeep® CJ7 & CJ8 82-86, Dana 30 27-Spline Kit [Wide-Trac Kit] | 12142 | 27 | 27 | D30 |
| Jeep® Wrangler [YJ] 87-95, Dana 30 27-Spline Kit [Disconnect Eliminator] | 12145 | 27 | 27 | D30 |
| Jeep® Wrangler [YJ] 87-95, Dana 30 30-Spline Kit | 12131 | 30 | 27 | D30 |
| Jeep® Wrangler [YJ] 87-95, Dana 30 30-Spline Kit w/ARB Locker , 3.73 & Up | 12131-ARB | 30 | 27 | D30 |
| Jeep® Wrangler [YJ] 87-95, Dana 30 Grande 30/30-Spline Kit [30-Spline Inners & Outers] | 12231 | 30 | 30 | D30 |
| Jeep® Wrangler [YJ] 87-95, Dana 30 Grande 30/30-Spline Kit w/ ARB Locker [30-Spline Inners & Outers] ² , 3.73 & Up | 12231-ARB | 30 | 30 | D30 |
| Jeep® Wrangler [TJ] 97-06, Dana 30 27-Spline Kit | 12148 | 27 | 27 | D30 |
| Jeep® Wrangler [TJ] 97-06, Dana 30 Grande 30-Spline Kit ³ | 12132 | 30 | 27 | D30 |
| Jeep® Wrangler [TJ] 97-06, Dana 30 Grande 30-Spline Kit w/ ARB Locker, 3.73 & Up | 12132-ARB | 30 | 27 | D30 |
| Jeep® Wrangler [TJ] 97-06, Dana 30 Grande 30/30-Spline Kit [30-Spline Inners & Outers] ^{1,2,3} | 12232 | 30 | 30 | D30 |
| Jeep® Wrangler [TJ] 97-06, Dana 30 Grande 30/30-Spline Kit w/ ARB Locker [30-Spline Inners & Outers] ^{1,2} , 3.73 & Up | 12232-ARB | 30 | 30 | D30 |
| Jeep® Wrangler [TJ] Rubicon 03-06, Dana 44 Grande 30-Spline Kit | 12165 | 30 | 27 | D44 |
| Jeep® Wrangler [TJ] Rubicon 03-06, Dana 44 30/30-Spline Kit [30-Spline Inners & Outers] ¹ | 12265 | 30 | 30 | D44 |

¹ NOTE: This kit includes upgraded 30 spline bearing hub units.

² NOTE: When converting to 30 spline outer axles, 1999 and older models must use the 2000-06 Wrangler rotor [Omix 16702.05].

³ NOTE: Upgrade to 30 spline locker required.

⁴ NOTE: Not available at the time of this printing. Will be announced when available.

CJ & Wrangler 76-06

GRANDE OUTER STUB UPGRADE

Grande 30 spline outer stub upgrade replaces factory 27 spline outer stub axles to 30 spline.

Kit includes:

- 2 - 30 Spline Chromoly Axle Stub Shafts
- 2 - 30 Spline Unit Bearings
- 2 - Alloy X-Joints



| Application | Part # |
|---|--------|
| Jeep® Wrangler [YJ, TJ] 87-06, 30-Spline Outer/Unit Bearing Upgrade Kit | 12168 |
| Jeep® Wrangler [TJ] 00-06, 30-Spline Bearing Service Unit | 35400 |

NOTE: When converting to 30 spline outer axles, 1999 and older models must use the 2000-06 Wrangler brake rotor [Omix 16702.05].

ALLOY USA® DANA 30 MANUAL LOCKING HUB CONVERSION KITS

Alloy USA® Grande Hub Conversion Kits Feature:

- Better fuel economy by freewheeling in 2WD mode. Decreases tire wear since unlocked manual hubs rotate more freely.
- Includes beefy corrosion resistant die cast aluminum Rugged Ridge® Manual Locking Hubs.

| Deluxe Hub Conversion with Alloy USA® Inner & Outer Axles | Part # |
|--|----------|
| 87-95 YJ [Eliminates Disonnects], 97-06 TJ, D30 Manual Locking Hub Deluxe Conversion Kit, Includes Alloy USA® Inner Axle Shafts NEW | 12198 |
| Standard Hub Conversion without Inner Shafts | |
| 87-95 Wrangler [YJ], D30 Manual Locking Hub Conversion Kit NEW | 12194 |
| 97-06 Wrangler [TJ], D30 Manual Locking Hub Conversion Kit NEW | 12195 |
| Rotor Brake For Front Hub Conversion | |
| 87-95 Wrangler [YJ], 97-06 Wrangler [TJ] NEW | 16702.13 |



NEW!

12198



High tensile strength 4140 Chromoly is heat-treated, tempered and induction hardened to produce these heavy-duty axles that are up to 35% stronger than stock 1040 axles. Alloy USA® uses the latest cold rolled splining technology, to produce splines that are stronger than traditional cut splines. Our shafts are covered by an exclusive 10-year warranty! Rear axle shaft kits include everything you need for your installation: both passenger and drive side shafts, seals, bearings and wheel studs. Upgraded spline counts for Jeep® applications: Dana 35 spline upgrades from 27 splines to 30 splines. Dana 44 spline upgrades from 30 splines to 33 and 35 splines.

PERFORMANCE REAR AXLE KITS FOR JEEP®

Jeep® 2 Axles - Bearings - Seals - Wheel Studs

| | Part # | Spline | Axle |
|---|-----------|--------|------|
| Jeep® CJ5 76-83, CJ7 & CJ8 76-81, AMC 20, 1-Piece Conversion, Narrow-Trac, Kit | 12125 | 29 | M20 |
| Jeep® CJ7 76-79, AMC 20, 1-Piece Conversion, Quadratrac Kit | 12127 | 29 | M20 |
| Jeep® CJ7 & CJ8 82-86, AMC 20, 1-Piece Conversion, Wide-Trac Kit | 12126 | 29 | M20 |
| Jeep® Wrangler [YJ] 87-89, Dana 35 Grande 30-Spline Kit, [Non C-clip] ¹ | 12133 | 30 | D35 |
| Jeep® Wrangler [YJ] 87-89, Dana 35 Grande 30-Spline Kit With ARB Locker [Non C-clip], 3.54 & Up | 12133-ARB | 30 | D35 |
| Jeep® Wrangler [YJ] 87-89, Dana 35 Grande 30-Spline Kit With Detroit Locker [Non C-clip], 3.54 & Up | 12133-DET | 30 | D35 |
| Jeep® Wrangler [YJ] 90-95, [TJ] 97-06, Dana 35 27-Spline Kit, [C-clip, Without ABS] | 12200 | 27 | D35 |
| Jeep® Wrangler [YJ] 90-95, [TJ] 97-06, Dana 35 Grande 30-Spline Kit, [C-clip, Without ABS] ¹ | 12134 | 30 | D35 |
| Jeep® Wrangler [YJ] 90-95, [TJ] 97-06, Dana 35 Grande 30-Spline Kit With ARB Locker, [C-clip, Without ABS], 3.54 & Up | 12134-ARB | 30 | D35 |
| Jeep® Wrangler [YJ] 90-95, [TJ] 97-06, Dana 35 Grande 30-Spline Kit With Detroit Locker, [C-clip, Without ABS], 3.54 & Up | 12134-DET | 30 | D35 |
| Jeep® Wrangler [TJ] 97-06, Dana 44 30-Spline Kit | 12135 | 30 | D44 |
| Jeep® Wrangler [TJ] 97-06, Dana 44 30-Spline Kit NEW | 12235 | 30 | D44 |
| Jeep® Wrangler [TJ] 97-06, Dana 44 Grande 33-Spline Kit ² | 12136 | 33 | D44 |
| Jeep® Wrangler [TJ] 97-06, Dana 44 Grande 33-Spline Kit With ARB Locker, 3.92 & Up | 12136-ARB | 33 | D44 |
| Jeep® Wrangler [TJ] 97-06, Dana 44 Grande 33-Spline Kit With Detroit Locker, 3.92 & Up | 12136-DET | 33 | D44 |
| Jeep® Wrangler [TJ] 97-06, Dana 44 Mas Grande 35-Spline Kit ³ | 12137 | 35 | D44 |
| Jeep® Wrangler [TJ] 97-06, Dana 44 Mas Grande 35-Spline Kit With ARB Locker, 3.92 & Up | 12137-ARB | 35 | D44 |

¹ Upgrade to 30 spline locker required.
² Upgrade to 33 spline locker required.
³ Upgrade to 35 spline locker required.



PERFORMANCE REAR AXLE SHAFTS

Jeep® Axle Shafts, Sold Individually.

Wheel Bearings, Seals, & Wheels Studs Available Separately

| | Part # | Hollander | Spline | Length | Side | Axle |
|--|--------|-----------|--------|----------|-------|------|
| Jeep® CJ5 72-75, Dana 44, LH/RH, 30-Spline | 21147 | NA | 30 | 24-3/4" | LH/RH | D44 |
| Jeep® CJ5 76-83, CJ7 & CJ8 76-81, AMC 20, 2-Piece OE Style RH, Narrow-Trac | 21130 | NA | 29 | 29" | RH | M20 |
| Jeep® CJ5 76-83, CJ7 & CJ8 76-81, AMC 20, 2-Piece OE Style LH, Narrow-Trac | 21131 | NA | 29 | 26-1/4" | LH | M20 |
| Jeep® CJ5 76-83, CJ7 & CJ8 76-81, AMC 20, 1-Piece Conversion RH, Narrow-Trac | 21101 | NA | 29 | 23.06" | RH | M20 |
| Jeep® CJ5 76-83, CJ7 & CJ8 76-81, AMC 20, 1-Piece Conversion LH, Narrow-Trac | 21100 | NA | 29 | 26.03" | LH | M20 |
| Jeep® CJ7 76-79, AMC 20, 2-Piece OE Style RH, Quadratrac | 21132 | NA | 29 | 22" | RH | M20 |
| Jeep® CJ7 76-79, AMC 20, 2-Piece OE Style LH, Quadratrac | 21133 | NA | 29 | 33-1/2" | LH | M20 |
| Jeep® CJ7 76-79, AMC 20, 1-Piece Conversion RH, Quadratrac | 21104 | NA | 29 | 19" | RH | M20 |
| Jeep® CJ7 76-79, AMC 20, 1-Piece Conversion LH, Quadratrac | 21105 | NA | 29 | 30-7/16" | LH | M20 |
| Jeep® CJ7 & CJ8 82-86, AMC 20, 2-Piece OE Style RH, Wide-Trac | 21134 | NA | 29 | 31-9/16" | RH | M20 |
| Jeep® CJ7 & CJ8 82-86, AMC 20, 2-Piece OE Style LH, Wide-Trac | 21135 | NA | 29 | 28-9/16" | LH | M20 |
| Jeep® CJ7 & CJ8 82-86, AMC 20, 1-Piece Conversion RH, Wide-Trac | 21103 | NA | 29 | 28-7/16" | RH | M20 |
| Jeep® CJ7 & CJ8 82-86, AMC 20, 1-Piece Conversion LH, Wide-Trac | 21102 | NA | 29 | 25.19" | LH | M20 |
| Jeep® Wrangler [YJ] 87-89, Dana 35, RH, 27-Spline w/o ABS | 21136 | 1799R | 27 | 28.94" | RH | D35 |
| Jeep® Wrangler [YJ] 87-89, Dana 35, LH, 27-Spline w/o ABS | 21137 | 1799L | 27 | 30.35" | LH | D35 |
| Jeep® Wrangler [YJ] 90-92, Dana 35, RH, 27-Spline w/ ABS NEW | 21138 | NA | 27 | 29.04" | RH | D35 |
| Jeep® Wrangler [YJ] 90-92, Dana 35, LH, 27-Spline w/ ABS NEW | 21139 | NA | 27 | 30.54" | LH | D35 |
| Jeep® Wrangler [YJ] 90-95, [TJ] 97-06, Dana 35, RH, 27-Spline w/o ABS | 21120 | 1797R | 27 | 29-1/16" | RH | D35 |
| Jeep® Wrangler [YJ] 90-95, [TJ] 97-06, Dana 35, LH, 27-Spline w/o ABS | 21121 | 1797L | 27 | 30-9/16" | LH | D35 |
| Jeep® Wrangler [YJ] 93-95, [TJ] 97-02, Dana 35, RH, 27-Spline w/ ABS & Drum NEW | 21140 | 1832R | 27 | 29" | RH | D35 |
| Jeep® Wrangler [YJ] 93-95, [TJ] 97-02, Dana 35, LH, 27-Spline w/ ABS & Drum NEW | 21141 | 1832L | 27 | 30-5/8" | LH | D35 |
| Jeep® Wrangler [TJ] 03-06, Dana 35, RH, 27-Spline w/ABS & Rear Drum NEW | 21148 | NA | 27 | 29" | RH | D35 |
| Jeep® Wrangler [TJ] 03-06, Dana 35, LH, 27-Spline w/ABS & Rear Drum NEW | 21149 | NA | 27 | 29.06" | LH | D35 |
| Jeep® Wrangler [TJ] 03-06, Dana 35, RH, 27-Spline w/ABS & Rear Disc NEW | 21150 | NA | 27 | 29" | RH | D35 |
| Jeep® Wrangler [TJ] 03-06, Dana 35, LH, 27-Spline w/ABS & Rear Disc NEW | 21151 | NA | 27 | 29.75" | LH | D35 |
| Jeep® Wrangler [TJ] 97-06, Dana 44, RH, 30-Spline w/o ABS NEW | 21106 | 2416R | 30 | 29-3/4" | RH | D44 |
| Jeep® Wrangler [TJ] 97-06, Dana 44, LH, 30-Spline w/o ABS NEW | 21107 | 2416L | 30 | 29-1/4" | LH | D44 |
| Jeep® Wrangler [TJ] 03-06, Dana 44, RH, 30-Spline w/ABS & Rear Drum NEW | 21142 | NA | 30 | 29-3/4" | RH | D44 |
| Jeep® Wrangler [TJ] 03-06, Dana 44, LH, 30-Spline w/ABS & Rear Drum NEW | 21143 | NA | 30 | 29-1/4" | LH | D44 |
| Jeep® Wrangler [TJ] 03-06, Dana 44, RH, 30-Spline w/ABS & Rear Disc NEW | 21144 | NA | 30 | 29-3/8" | RH | D44 |
| Jeep® Wrangler [TJ] 03-06, Dana 44, LH, 30-Spline w/ABS & Rear Disc NEW | 21145 | NA | 30 | 30-1/16" | LH | D44 |

All images are subject to be representative. More detailed information is available online.

JEEP® RING & PINIONS

These affordable high strength gear sets come in all the popular ratios to satisfy everyone's gearing needs. Oversized tires require higher ring & pinion ratios to restore performance. Made from high quality 8620 forgings and Gleason gear cutting technology, these gears are made to last. Complete installation kits are available separately to complete the job. Exclusive 5-year warranty. Available in 3.73, 4.10, 4.56, 4.88 and 5.13 ratios.



CJ & Wrangler 76-06

| Application | Ratio | Part # |
|---|-------|----------|
| FRONT | | |
| CJ5, CJ7, CJ8, 72-86, Dana 30 Front, 3.73 Ratio | 3.73 | D30373 |
| CJ5, CJ7, CJ8, 72-86, Dana 30 Front, 4.10 Ratio | 4.10 | D30410 |
| CJ5, CJ7, CJ8, 72-86, Dana Front 30, 4.56 Ratio | 4.56 | D30456 |
| CJ5, CJ7, CJ8, 72-86, Dana 30 Front 4.88 Ratio | 4.88 | D30488 |
| Wrangler [YJ] 87-95, Dana 30 Reverse, 3.73 Ratio | 3.73 | D30373R |
| Wrangler [YJ] 87-95 Dana 30 Reverse, 4.10 Ratio | 4.10 | D30410R |
| Wrangler [YJ] 87-95, Dana 30 Reverse, 4.56 Ratio | 4.56 | D30456R |
| Wrangler [YJ] 87-95, Dana 30 Reverse, 4.88 Ratio | 4.88 | D30488R |
| Wrangler [TJ] 97-06, Front Dana 30, 3.73 Ratio [Short] | 3.73 | D30373TJ |
| Wrangler [TJ] 97-06 Front Dana 30, 4.10 Ratio [Short] | 4.10 | D30410TJ |
| Wrangler [TJ] 97-06, Dana 30, 4.56 Ratio [Short] | 4.56 | D30456TJ |
| Wrangler [TJ] 97-06, Dana 30 4.88 Ratio [Short] | 4.88 | D30488TJ |
| Wrangler [TJ] Rubicon 03-06, Front/Rear Dana 44, 4.88 Ratio | 4.88 | D44488X |
| Wrangler [TJ] Rubicon 03-06, Front/Rear Dana 44, 5.13 Ratio | 5.13 | D44513X |
| REAR | | |
| CJ5, CJ7, CJ8, 76-86, AMC 20, 3.73 Ratio | 3.73 | AMC373 |
| CJ5, CJ7, CJ8, 76-86, AMC 20, 4.10 Ratio | 4.10 | AMC410 |
| CJ5, CJ7, CJ8, 76-86, AMC 20, 4.56 Ratio | 4.56 | AMC456 |
| CJ5, CJ7, CJ8, 76-86, AMC 20, 4.88 Ratio | 4.88 | AMC488 |
| Wrangler [YJ, TJ] 87-06, Dana 35 Rear, 3.73 Ratio | 3.73 | D35373 |
| Wrangler [YJ, TJ] 87-06, Dana 35 Rear, 4.10 Ratio | 4.10 | D35410 |
| Wrangler [YJ, TJ] 87-06, Dana 35 Rear, 4.56 Ratio | 4.56 | D35456 |
| Wrangler [YJ, TJ] 87-06, Dana 35, 4.88 Ratio | 4.88 | D35488 |
| Wrangler [TJ] 97-06, Rear Dana 44, 3.73 Ratio | 3.73 | D44373 |
| Wrangler [TJ] 97-06, Rear Dana 44, 4.10 Ratio | 4.10 | D44410 |
| Wrangler [TJ] 97-06, Rear Dana 44, 4.56 Ratio | 4.56 | D44456 |
| Wrangler [TJ] 97-06, Rear Dana 44, 4.88 Ratio | 4.88 | D44488 |
| Wrangler [TJ] 97-06, Rear Dana 44, 5.13 Ratio | 5.13 | D44513 |
| Wrangler [TJ] Rubicon 03-06, Front/Rear Dana 44, 4.88 Ratio | 4.88 | D44488X |
| Wrangler [TJ] Rubicon 03-06, Front/Rear Dana 44, 5.13 Ratio | 5.13 | D44513X |

RING & PINION MASTER INSTALLATION & OVERHAUL KITS FOR JEEP®

These great kits offer all the components you will need to complete your differential rebuild or ring & pinion installation. Complete with bearings, pinion seals, pinion shims, crush sleeve, pinion nut, ring gear bolts and marking compound.



| Application | Part # |
|---|--------|
| CJ5, CJ7, CJ8 72-86, Dana 30, Front | 352065 |
| CJ5, CJ7, CJ8, 72-86, AMC Model 20 | 352025 |
| CJ5, CJ7, 72-75, Dana 44 Rear | 352033 |
| Wrangler [YJ] 87-95, Dana 30 Front | 352032 |
| Wrangler [YJ, TJ] 87-06, Dana 35 Rear | 352049 |
| Wrangler [TJ] 97-06, Dana 30 Front | 352031 |
| Wrangler [TJ] 97-06, Dana 44 Rear | 352033 |
| Wrangler [TJ] Rubicon 03-06, Dana 44 Front/Rear | 352045 |

HD DIFFERENTIAL COVERS

Indestructible! You won't break these covers, we guarantee it. Made from either 3/8" cast steel or 5/16" stamped steel, painted black inside and out, these heavy-duty covers are designed to protect your differential and all its working parts for as long as you own your vehicle. These indestructible covers have been ".44 caliber tested" - if they can take a bullet at point blank range [don't try this at home!], they can take all that the trail has to offer. Available for most popular Dana differential types and include extra reinforcement protection for the fill plug area. All mounting hardware and instructions are included for ease of installation.



| Differential Cover Application | Cast 3/8" Steel | Stamped 5/16" Steel |
|--------------------------------|-----------------|---------------------|
| HD AMC 20 | 11205 | - |
| HD Dana 30 | 11206 | 11200 |
| HD Dana 35 | 11201 | - |
| HD Dana 44 | 11202 | - |
| HD Dana 60 | 11207 | 11203 |



WHEEL SPACERS



- Moves your wheels out to help fit wider tires-creates extra stability.
- Hub centric design to assure wheel balance.
- Constructed of durable 6061T6 aluminum for long life, extra strength and corrosion resistance.
- Available in 1.25" to 1.5" widths for today's most popular wheel sizes.
- Each pair includes pre-installed grade 8 wheel studs, 10 lug nuts and thread locker.
- Wheel adaptors convert current bolt patterns to alternate bolt patterns for use with different wheels.
- Wheel Spacers and Wheel adaptors are sold in pairs.

WHEEL SPACERS

| APPLICATION | Width | Bolt Pattern | Part # |
|---------------------------------|-------|--------------|--------|
| Jeep® CJ 45-86 NEW | 1.25" | 5 on 5.5" | 11302 |
| Jeep® Wrangler 87-06 NEW | 1.25" | 5 on 4.5" | 11301 |

WHEEL ADAPTERS

| APPLICATION | Width | Conversion | Part # |
|---------------------------------------|-------|------------------------|--------|
| Jeep® Wrangler 87-06, Pair NEW | 1.25" | 5 on 4.5" to 5 on 5.5" | 11310 |



SLOTTED BRAKE ROTORS

Alloy USA® slotted & drilled brake rotors improve braking performance right out of the box. Slotted & drilled for maximum cooling! Slotted rotors improve brake pad bite & reduce brake fade.

| APPLICATION | Part # |
|---|--------|
| 90-99 Wrangler, (4WD Only), Disc Brake Rotor (Front) NEW | 11350 |
| 00-06 Wrangler, Disc Brake Rotor (Front) NEW | 11351 |
| 03-06 Wrangler, Disc Brake Rotor (Rear) NEW | 11352 |

**ALLOY USA® FRONT AXLE X-JOINT
COLD FORGED · SERVICEABLE**

Now a serviceable U-joint for Dana 44 applications is available to you. Replace your 760X U-joint with Alloy USA's new X-joint!



| APPLICATION | Part # |
|--|--------|
| Heavy Duty Alloy X-joint, Complete U-joint With Bearings (760 Style) Replaces 5-297X/5-760X NEW | 11500 |

OTHER U-JOINTS



Direct OE replacement

| APPLICATION | Part # |
|--|--------|
| 1310-1330 Conversion U-Joint, 94-97 Wrangler for CV Driveshaft | 5-134X |

DANA 60 / 70 YOKE 1410 SERIES YOKE CONVERSION KITS

Genuine Dana Spicer NOS yoke for 1410 series U-Joint. Some oxidization may have occurred during shelf life.



These great Conversion Kits allow you to convert your old strap style yoke to the newer stronger u-bolt design. Not only is the U-bolt kit stronger, it makes changing out a failed U-joint a painless process. The kit includes a new yoke, pinion nut, pinion spacer, pinion seal, u-joint and u-bolts. Alloy USA uses premium Spicer U-joints in all their yoke kits.



| Description | Part # |
|--|-------------|
| Dana 60 / 70 Yoke 1410 Series NEW | 3-4-5711-1X |

| YOKE CONVERSION KITS - Converts Strap To U-Bolt Design, Includes Spicer U-Joint & U-Bolts | Part # |
|---|--------|
| CJ5 76-81, CJ7, CJ8 76-86, AMC 20 | 380003 |
| CJ5, CJ7, CJ8, 72-86, Wrangler [YJ, TJ] 87-06, Dana 30 | 380001 |
| Wrangler [YJ] 87-93, Wrangler [TJ] 97-02, Dana 35 | 380002 |

All images are subject to be representative. More detailed information is available online.

DIFFERENTIAL CABLE LOCK KITS



The Alloy USA® Differential Cable Lock Kit is a permanent replacement for the failure prone OE vacuum disconnect system. The kit allows you to engage and lock the front axle from inside the cab. A 1inch pull of the cable ensures you will have four wheel drive when you need it for as long as the transfer case is engaged. Backed by a three year warranty.



450400



APPLICATION

Part

| | |
|--|--------|
| Shift Fork, Cast Iron, For Use W/ Alloy USA or Posi Lok Differential Cable Lock Kit, Jeep® W/ Front Dana 30 Wrangler [YJ] 87-95 NEW | 450100 |
| Differential Cable Lock Kit, With Front D30 Axle, Jeep® Wrangler [YJ] 87-95 NEW | 450900 |
| Differential Cable Lock Kit, For 3-In To 6-In Lift, With Front D30 Axle, Jeep® Wrangler [YJ] 87-95 NEW | 450920 |
| Differential Permanent Cable Lock Kit, Jeep® w/ Front D30 Wrangler [YJ] 87-95 NEW | 451100 |

TRANSFER CASE CHAIN



If you're servicing your transfer case and your OE chain has more than 60,000 miles on it, it is time for a replacement. Why replace your chain when you can upgrade it? Our advanced Round Pin technology allows the chain to double back on itself and offer greater articulation than the standard rocker pin design. We use high tensile strength steel to ensure that your TC chain endures peak loads under heavy operating conditions repeatedly over time. Backed by an industry leading three year warranty.

Transfer Case Chain

Part

| | |
|---|-------|
| Transfer Case Chain, NP231 and NP233, 1" Width w/ 30 Links, Jeep® Wrangler [YJ] 87-95, [TJ] 97-06, NEW | 11650 |
| Quadratrac Transfer Case Chain, 2 5/8" Width w/ 48 Links, CJ7 76-79 w/ Automatic Transmission NEW | 11651 |

TRANSFER CASE SLIP YOKE ELIMINATOR KIT

This kit is a MUST if you installed a 2" or taller suspension lift on your 1988-2006 Wrangler (not needed for body lifted Jeeps®). The kit fits all 1988 and up NP 231 transfer cases. A Slip Yoke Eliminator Kit [SYE] will eliminate the need to drop your transfer case in order to avoid drive train vibrations that are caused by taller suspension lift. The purpose of this kit is to replace the slip yoke portion of the NP 231 with a fixed yoke and CV-style drive shaft assembly. This reduces drive shaft angle, improves bearing & U-joint life, and reduces driveline vibrations. It also has a shorter and stronger main shaft design with improved oiling. Will not work with cable driven speedometers. Not for use with Rubicon models.



11400 Slip Yoke Eliminator Kit

▲WARNINGS

WARNING: OEM slip yokes on 1988-2006 Jeep® Wrangler are not suitable for use with 2" or taller Rugged Ridge™ or other vendors' suspension lifts. Failure of slip yoke may result in damage to transfer case and/or loss of vehicle control. Use of this slip yoke eliminator kit is required for all suspension lifts 2" or taller. See additional product safety information and WARNINGS at back of catalog.

Transfer Case Slip Yoke Eliminator Kit

Part

| | |
|--|----------|
| 88-06 Wrangler, 88-01 Cherokee Slip Yoke Eliminator NEW [with NP231 transfer case] *, Kit | 11400 |
| Pinion Yoke | 18676.61 |
| Oil Seal | 18676.62 |
| Hardware Kit | 18676.64 |

* A CV Drive Shaft is required for this conversion kits. Sold separately on page C60.

ALLOY USA® AXLE TUBE SEALS

Keep water, mud and debris from entering your front axle housing. These CNC machined aluminum housings feature two seals to provide double protection from the crud.



APPLICATION

Part

| | |
|--|------------------------------|
| 1987-06 Wrangler [YJ,TJ] Dana 30 [1] | 11102 (RED) 11103 (BLACK) |
| 1987-06 Wrangler [YJ,TJ] Dana 30 or 44 front axle [2] NEW | 11105 (RED) 11106 (BLACK) |
| Replacement Inner Seal For 11102 and 11103 NEW | 11108 |
| Replacement Inner Seal For 11105 and 11106 NEW | 11109 |

[1] Note: Will not fit 87-95 Wranglers with O.E. front disconnect axle. Must upgrade to one piece axle. Will not fit Grande 30 spine axles. For 27 Spline applications only.

[2] Note: Will not fit 87-95 Wranglers with O.E. front disconnect axle. Must upgrade to 1 pc 30 spline grande axle. For use with all grande 30 spline axle upgrades & Rubicon Dana 44's.

LOCK RIGHT® LOCKERS

The Powertrax® Lock-Right® Lockers performance is equal to a solid spool axle, yet automatically unlocks to allow full differentiation in turns. The locker also reduces the excessive noise, tire wear, and drivetrain damage associated with other lockers. Powertrax lockers replace the spider gears in your differential carrier without affecting your ring and pinion settings. The whole job can be done in your driveway with common hand tools in a couple of hours. A carrier is not included. Whether it be snow, sand, mud, ice, etc... the LOCK-RIGHT will give you the traction you need.

| Application | Part # |
|--|----------|
| Lock Right Rear 45-49 CJ'S With Dana-41 | LR2416 |
| Lock Right Rear 45-62 CJ'S With 10-Spline Dana-44 | LR2415 |
| Lock Right Front 45-64 CJ's Dana-25 & 1964-71 CJ Dana-27 | LR2115 |
| Lock Right Rear 55-71 CJ'S With 19-Spline Dana-44 | LR2413 |
| Lock Right Rear 72-86 CJ'S With 30-Spline Dana-44, Also 1997-02 TJ | LR2410 |
| Lock Right Front 72-03 CJ, YJ, TJ | LR2210 |
| Lock Right Rear 76-86 CJ'S With AMC-20 | LR1710 |
| Lock Right Rear 87-93 YJ Dana-35 [Except 1993 W/ 605528 BOM] [Plus Z-Shaft] | LR2310S |
| Lock Right Rear 94-03 YJ & TJ Dana-35 [Also 1993 YJ 605528 BOM] [Plus Z-Shaft] | LR2311S |
| Lock Right Zytanium CrossShaft, Rear AMC-20 | LRSA1710 |
| Lock Right Zytanium CrossShaft, Front Dana-30 | LRSD2210 |
| Lock Right Zytanium CrossShaft, Rear Dana-44 | LRSD2410 |



LR2310S

CJ & Wrangler 76-06



DETROIT LOCKERS®

| Application | Part # |
|---|-----------|
| Detroit Locker, Soft Locker, Locking Differential, AMC 20 3.08 to 4.88 Ratio, Jeep® CJ 76-86 | 187SL47A |
| Detroit Locker, Truetrac, Limited Slip Differential, Dana 30 27 Spline 3.07 to 3.54 Gear Ratio, Jeep® CJ 72-86, Wrangler [YJ] 87-95, [TJ] 97-06 | 912A584 |
| Detroit Locker, Truetrac, Limited Slip Differential, Dana 30 27 Spline 3.07 to 3.73 Gear Ratio, Jeep® CJ 72-86, Wrangler [YJ] 87-95, [TJ] 97-06 | 912A585 |
| Detroit Locker, Soft Locker, Locking Differential, Dana 30 3.73 to 5.38 Ratio, Jeep® CJ 72-86, Wrangler [YJ] 87-95, [TJ] 97-06 | 162SL60B |
| Detroit Locker, Truetrac, Limited Slip Differential, Dana 30 3.73 to 5.38 Ratio, Jeep® CJ 72-86, Wrangler [YJ] 87-95, [TJ] 97-06 | 912A314 |
| Detroit Locker, Limited Slip Differential, Dana 35 27 Spline 3.54 to 5.38 Gear Ratio, Jeep® Wrangler [YJ] 87-95, [TJ] 97-06 | 162C56A |
| Detroit Locker, Truetrac, Limited Slip Differential, Dana 35 27 Spline 3.54 to 5.38 Gear Ratio, Jeep® Wrangler [YJ] 87-95, [TJ] 97-06 | 912A569 |
| Detroit Locker, Limited Slip Differential, Dana 35 30 Spline 3.54 TO 5.38, Jeep® Wrangler [YJ] 87-95, [TJ] 97-06 | 162C66A |
| Detroit Locker, Differential, Super Dana 44 33 SPLINE 3.92 + Gear Ratio, Jeep® 66-68 | 187SL192A |
| Detroit Locker, Truetrac, Limited Slip Differential, Dana 44 30 Spline 2.73 to 3.73 Gear Ratio, Jeep® CJ5 72-75, CJ7 86, Wrangler [TJ] 97-06 | 913A589 |
| Detroit Locker, Soft Locker, Locking Differential, Dana 44 30 Spline 2.73 to 3.73 Gear Ratio, Jeep® CJ5 72-75, CJ7 86, Wrangler [TJ] 97-06 | 187SL16D |
| Detroit Locker, Truetrac, Limited Slip Differential, Dana 44 30 Spline 3.92 to 5.38 Gear Ratio, Jeep® CJ5 72-75, CJ7 86, Wrangler [TJ] 97-06 | 913A590 |
| Detroit Locker, Truetrac, Limited Slip Differential, Dana 44 Front 30 Spline 2.73 TO 3.73 Gear Ratio, Jeep® Wrangler [TJ] 03-06 | 913A591 |
| Detroit Locker, Soft Locker, Locking Differential, Dana 44 3.92 to 5.38 Ratio, 30 Spline, Jeep® CJ 72-75 & 86, Wrangler [TJ] 97-06 | 187SL16C |

ARB® AIR LOCKERS

| Application | Part # |
|--|-----------|
| ARB Air Locker, 70-03 CJ, TJ, Dana 44 30 Spline 3.92 & UP Ratio | ARB-RD06 |
| ARB Air Locker, 70-03 CJ, TJ, Dana 44 30 Spline 3.73 & DOWN Ratio | ARB-RD07 |
| ARB Air Locker, 72-03 CJ, YJ, TJ Dana 30 27 Spline 3.73 & UP Ratio | ARB-RD100 |
| ARB Air Locker, 72-03 CJ, YJ, TJ, Dana 30 27 Spline 3.54 & DOWN Ratio | ARB-RD101 |
| ARB Air Locker, 76-86 CJ AMC 20 29 Spline 3.08 & Up Ratio | ARB-RD60 |
| ARB Air Locker, 90-06 YJ, TJ, Dana 35 W/C-CLIP 27 Spline 2.73-3.31 Ratio | ARB-RD103 |
| ARB Air Locker, 90-06 YJ, TJ, Dana 35 W/C-CLIP 27 Spline 3.54 & UP Ratio | ARB-RD102 |
| ARB Air Locker, Super Dana 30, 3.73 and Up Ratio | ARB-RD104 |
| ARB Air Locker, Super Dana 35, C-CLIP, 30 SPL, 3.54 and Up Ratio | ARB-RD105 |



ARB-RD105

RING & PINION



Precision Gear® understands the rigors of racing. Horsepower is useless unless you can get it to the ground. Most companies providing ring and pinions today look for the cheapest source without consideration of quality. They “stand behind” their product until the day you buy it and install it on your car. At Precision Gear® each ring and pinion we sell is backed by an exclusive five year warranty! Our gears are made from high quality 8620 forgings and Gleason gear cutting technology because our gears are made to last!



For additional product listings and more information visit www.precisiongear.com.

Master Installation Kits:

Precision Gear® understands the complexity of rebuilding your differential. To help solve this difficulty and eliminate multiple trips to the parts store we have included everything you need to complete your ring & pinion installation and get you back on the road quick all in one great kit.

Master Installation Kits Include:

- Carrier Bearings
- Pinion Bearings
- Pinion Nut
- Pinion Seal
- Preload Shims or Crush Collar
- Pinion Shims
- Gasket or RTV
- Marking Compound
- Differential Shims (where applicable)
- Locktite
- Oil Slingers (where applicable)
- Ring Gear Bolts (where applicable)



* Ring & Pinions and Installation Kits are sold separately.

| Dana 30 Ratio | Part # |
|----------------------------|----------|
| 3.07 | 30D/307 |
| 3.54 | 30D/354 |
| 3.73 | 30D/373 |
| 3.91 | 30D/391 |
| 4.10 | 30D/410 |
| 4.56 | 30D/456 |
| Master Installation Kit | 352032 |
| Spider Gear Kit NEW | 30D/SPGK |

| Dana 44 Ratio | Part # |
|-------------------------|-----------|
| 3.23 | 44D/323 |
| 3.31 | 44D/331 |
| 3.42 | 44D/342 |
| 3.54 | 44D/354 |
| 3.73 | 44D/373 |
| 4.09 | 44D/409 |
| 4.27 | 44D/427 |
| 4.56 | 44D/456 |
| 4.56 | 44D/456TH |
| 4.88 | 44D/488 |
| 4.88 | 44D/488TH |
| 5.13 | 44D/513 |
| Master Installation Kit | 352033 |

| AMC 20 Ratio | Part # |
|-------------------------|---------|
| 3.08 | AMC/308 |
| 3.54 | AMC/354 |
| 3.73 | AMC/373 |
| 4.10 | AMC/410 |
| 4.56 | AMC/456 |
| Master Installation Kit | 352025 |

| Dana 35 Ratio | Part # |
|-------------------------|---------|
| 3.55 | 35D/355 |
| 3.73 | 35D/373 |
| 4.10 | 35D/410 |
| 4.56 | 35D/456 |
| 4.88 | 35D/488 |
| Master Installation Kit | 352049 |

| Dana 60 Ratio | Part # |
|-------------------------|----------|
| 3.54 | 60D/354 |
| 3.73 | 60D/373 |
| 4.10 | 60D/410 |
| 4.56 | 60D/456 |
| 4.56 | 60D/456R |
| 4.88 | 60D/488 |
| 5.13 | 60D/513 |
| 513 | 60D/513R |
| Master Installation Kit | 352034 |

| Dana 44 Reverse Ratio | Part # |
|-------------------------|----------|
| 3.07 | 44D/307R |
| 3.50 | 44D/350R |
| 3.54 | 44D/354R |
| 3.73 | 44D/373R |
| 4.09 | 44D/409R |
| 4.56 | 44D/456R |
| 4.88 | 44D/488R |
| 5.13 | 44D/513R |
| Master Installation Kit | 352033A |

| Dana 35 Reverse Ratio | Part # |
|-------------------------|----------|
| 4.56 | 35D/456R |
| 4.88 | 35D/488R |
| 5.13 | 35D/513R |
| Master Installation Kit | 352049A |



INTERIOR

| | |
|------------------------------|-------|
| FLOOR LINERS | X6 |
| INTERIOR STORAGE/ ORGANIZERS | X5 |
| INTERIOR ACCESSORIES | X7 |
| SEATS & SEAT COVERS | X4-X5 |

PERFORMANCE

| | |
|----------------------|-----|
| AIR INTAKE KITS | X16 |
| EXHAUST HEADERS | X16 |
| THROTTLE BODY SPACER | X16 |

EXTERIOR

| | |
|-------------------------|---------|
| BULL BARS | X2 |
| BUMPER SYSTEMS | X2 |
| EXTERIOR ENHANCEMENTS | X8 |
| FLARES & FENDERS | X3 |
| HEAVY DUTY ACCESSORIES | X14 |
| OFF ROAD LIGHTING | X12-X13 |
| SKID PLATES | X14 |
| TOWING | X15 |
| TUBE STEPS | X2 |
| WHEELS | X3 |
| WINCHES & RECOVERY GEAR | X9-X11 |

SUSPENSION

| | |
|----------------------|-----|
| BRAKE HOSES | X21 |
| POLYURETHANE | X21 |
| SUSPENSION KITS | X20 |
| SHOCKS & STABILIZERS | X19 |

AXLE

| | |
|--------------------------|---------|
| DIFFERENTIAL COVERS | X26 |
| FRONT AXLE KITS | X24 |
| HUB CONVERSION KITS | X24 |
| LOCKERS | X27 |
| REAR AXLE KITS | X25 |
| RING & PINIONS | X28 |
| WHEEL SPACERS & ADAPTERS | X3, X26 |

Cherokee 84-12

FRONT TUBE BUMPER

All Rugged Ridge® Front and Rear Bumpers feature smooth ground welds for an unbelievable look and further rust protection. No other tubular bumper manufacturer goes to the expense of smooth grinding their welds. This exclusive smooth grind process virtually eliminates small weld “pockets” that never seem to get full paint coverage and tend to rust over time. Finally, all Rugged Ridge® Bumpers feature welded end caps rather than plastic end caps. Gone are the days of constantly replacing those lost tube bumper end caps after a long day on the trail.



11560.80

Front Bumpers

| | | Part# |
|----------------------|--------------------------------|----------|
| 84-96 Cherokee XJ | Front Bumper w/Riser | 11560.80 |
| For All Tube Bumpers | License Plate Mounting Bracket | 11503.80 |
| For All Tube Bumpers | Light Mounting Bracket | 11503.81 |
| For All Tube Bumpers | CB Antenna Mounting Bracket | 11503.88 |



11503.88 CB Antenna Mounting Bracket



11503.81 Light Bracket



11503.80 License Plate Mounting Bracket

Cherokee 84-12

REAR TUBE BUMPER

Get the off-road look with a Rugged Ridge® Tube Bumper! Each bumper has smooth ground welds, welded end caps (not plastic end caps!) and the unique style only available from Rugged Ridge®.



Welded end caps, not plastic!

Rear Tube Bumpers

| | Black |
|-----------------------------|----------|
| 84-96 Cherokee, Black, Each | 11570.80 |

SIDE TUBE STEPS

Whether you want to dress it up flashy or keep it subtle, Rugged Ridge® has a tube step style just for you. Why settle for only one tube style when Rugged Ridge® offers so much more?



11590.81

3" Side Tube Steps

| | Black | Stainless |
|---------------------------------------|----------|-----------|
| 84-01 Cherokee 3" Round, 4-Door* Pair | 11590.81 | - |
| 99-04 Grand Cherokee 3" Round Pair | - | 81593.32 |
| 05-10 Grand Cherokee 3" Round Pair | - | 81593.33 |
| 11-12 Grand Cherokee 3" Round Pair | - | 81593.39 |

* Can be used for 2-Door XJ's but has two step pads per side.

BULL BARS

Year/Model

| | Stainless |
|-------------------------------|-----------|
| 05-07 Grand Cherokee 3" Bar | 82501.25 |
| 08-10 Grand Cherokee 3" Bar | 82501.26 |
| 11-12 Grand Cherokee 2.5" Bar | 82501.30 |



82501.25



Rugged Ridge® provides the most comprehensive replacement Fender Flare program on the market today. Rugged Ridge® has you covered when it is time to replace or upgrade your Factory Fender Flares. Each Flare is constructed of virtually indestructible, durable, UV treated thermoplastic to provide years of service. Each replacement flare is designed to fit into your factory mounting holes [some models may require some hole relocation] for ease of installation.

REPLACEMENT FENDER FLARE KITS

| 11605.01 | Fender Flare Kit | Part # |
|---|--|----------|
| Replacement Fender Flare Kit, 84-96 Cherokee XJ | 84-96 Cherokee [XJ] 4-pc kit w/out hardware | 11605.01 |

ALL TERRAIN FENDER FLARE KITS

Get that aggressive off road look with the NEW Rugged Ridge® All Terrain Fender Flare! These 6" flares feature a stylish design while protecting your vehicles paint from flying rocks and mud. Constructed of durable UV treated ABS with a slight texture, these paintable flares provide a great look while being able to handle whatever nature throws at them. Each All Terrain Flare is designed to allow larger wheels and tires to fit in the wheel wells [some drilling and cutting maybe required]. Durable rust proof stainless fasteners included with each kit. Backed by an industry leading 3 year limited warranty, these NEW All Terrain Flares will really set you apart from the crowd!

| Off Road Flare Kits | Part # |
|---|----------|
| All Terrain Fender Flare Kit, 84-01 4-Door Cherokee* NEW | 11634.10 |
| All Terrain Fender Flare Kit, 93-98 Grand Cherokee NEW | 11635.10 |

*97-01 Cherokee models required modifying OE rear bumper cover.

STEEL D-WINDOW WHEELS

Legendary looks, brutally epic strength. Each Rugged Ridge® steel wheel is stamped from heavy gauge steel and powder coated with a durable black finish. Our wheels have been engineered, tested and certified to meet and exceed the strenuous SAE J2530 standards for wheel strength and durability. Turning a million cycles at double their load capacity to ensure they could hold up to abuses of off road use. Because a Jeep® isn't a Jeep® until its lifted and outfitted with oversized tires. Includes center cap.



| Description | Part # |
|---|----------|
| Steel wheel D-Window, Black, 15X8, 5 on 4.5 bolt pattern, 3.75 backspacing, Cherokee [XJ] 84-01, Grand Cherokee [ZJ] 93-98 | 15500.01 |
| Steel wheel D-Window, Black, 15X10, 5 on 4.5 bolt pattern, 3.75 backspacing, Cherokee [XJ] 84-01, Grand Cherokee [ZJ] 93-98 | 15500.02 |



15201.02
Wheel Spacer,
5 on 4.5" Bolt
Pattern

RUGGED RIDGE® WHEEL SPACERS

These hub centric spacers / adapters move your wheels out to help fit wider tires and give your vehicle a wider track and improve stability. Constructed of double anodized black extra thick 6061T6 aluminum for long life and extra corrosion resistance. All hardware is grade-8 for extra strength. Each part number comes as a spacer pair. Included are 10 pre-installed grade-8 wheel studs, 10 lug nuts and thread locker.

| Wheel Spacer Kit | Width | Bolt Pattern | Part # |
|--|-------|----------------------|----------|
| 84-01 Cherokee, Grand Cherokee 93-98, Pair | 1.25" | 5 on 4.5" | 15201.02 |
| 84-01 Cherokee, Grand Cherokee 93-98, Pair | 1.5" | 5 on 4.5" | 15201.08 |
| Wheel Adapter Kit | Width | Conversion | Part # |
| 84-01 Cherokee, Grand Cherokee 93-98, Pair | 1.25" | 5 on 5" to 5 on 4.5" | 15201.04 |

CAUTION!

CAUTION: Rugged Ridge® recommends use of wheel spacers with all suspension lifts to reduce risk of roll over or other accident associated with modifying ride height for increased off road capabilities. See additional product safety information and WARNINGS at back of catalog.



Cherokee 84-12

FEATURES & BENEFITS OF THE NEW XHD SEAT DESIGN

- Bolt-in solution for 84-01 XJ Cherokees! The first bolt-in solution—No adapters necessary!
- Durable powder coat painted welded interior frame to prevent interior seat rust and provide lasting comfort.
- Special patent pending seat base design that allows for easy installation in all 84-01 XJ Cherokees without any adaptor brackets! Saves you money, provides extra strength and provides true ease of installation!
- Each XHD Seat is designed to allow full functionality on 84-01 XJ Cherokees. The unique design incorporates the factory front slider feature along with a built-in reclining mechanism for driver comfort. Only XHD Seating from Rugged Ridge® gives you these options for XJ Cherokees!
- Heavy Duty seat base incorporates a CAD designed girder system which provides twice the strength of any other replacement seat on the market today. This design is the most advanced seat base ever created in the last 30 years!
- Dense foam pack and heavy duty raised spring design creates a more comfortable seating experience. This "comfort design" has been created to ensure seat longevity and comfort all in one package.
- Four heat treated grade eight 7/16" side bolts attach the seat base to the seat back. This increased bolt size (most seats use 8 MM bolts) strengthens the seat back and meets DOT standards in 84-01 XJ Cherokees.
- Tough automotive grade vinyl or woven fabric [XHD Off-Road Seat] and matching stitch patterns provide a great look in your Jeep® and tough "off road rated" performance.
- All lower seating areas have an expanded bolster area providing a wider seating space and more comfort. Wider bolsters also provide easier access/exit while entering and leaving the vehicle.
- A low profile seating surface along with not having to use adaptor brackets provides less steering wheel interference and more comfort. These seats have been specially designed for the true Jeep® enthusiast!
- Infinitely adjustable reclining mechanism lets you customize the seat recline position for the ultimate in comfort.
- Each seat offers an industry leading 3 year limited warranty.



Cherokee 84-12

XHD ULTRA SEAT

- Our full featured seat design with a removable and adjustable head rest.
- Expanded top and bottom side bolsters cradle the driver in comfort.
- Stylish racing design up-grades the look of any Jeep® interior.
- Constructed of durable automotive grade textured vinyl and available in four factory matching colors: Non-textured Black, Gray, Black Denim, Spice.
- Infinite recline mechanism.

XHD RECLINING SEAT

- Low cost seat replacement option. Style matches the original Jeep® look with horizontal stitching and infinite recline mechanism.
- Great entry level price point for 84-01 XJ Cherokees.
- Constructed of durable automotive grade textured vinyl and available in three factory matching colors: Gray, Black Denim, Spice.

| XHD Ultra Seat | Part # |
|---|----------|
| 84-01 Cherokees, Front Seat, XHD Ultra Seat with Recliner, Black NEW | 13446.01 |
| 84-01 Cherokees, Front Seat, XHD Ultra Seat with Recliner, Gray NEW | 13446.09 |
| 84-01 Cherokees, Front Seat, XHD Ultra Seat with Recliner, Black Denim NEW | 13446.15 |
| 84-01 Cherokees, Front Seat, XHD Ultra Seat with Recliner, Spice NEW | 13446.37 |

| XHD Replacement Seat | Part # |
|--|----------|
| 84-01 Cherokees, Front Seat, XHD Reclining, Gray NEW | 13445.09 |
| 84-01 Cherokees, Front Seat, XHD Reclining, Black Denim NEW | 13445.15 |
| 84-01 Cherokees, Front Seat, XHD Reclining, Spice NEW | 13445.37 |



13448.53
XHD Off Road Seat

NEW!



13446.15
XHD Ultra Seat

NEW!



13447.37
XHD Sierra Seat

NEW!



13445.09
XHD Replacement Seat

NEW!

XHD OFF ROAD SEAT

- A true off road design, this fabric and vinyl seat offers true performance while providing the comfort of our other XHD designs.
- Each off-road seat has a built in adjustable lumbar support that adjusts quickly and easily.
- Each seat has three seat belt harness cutouts for use with a multi-point racing seat belt harness.
- Constructed of durable automotive grade woven fabric with vinyl trim for long life and cool comfort in the summer.
- XHD Off-Road Seats are available in three, two color/fabric styles to complement your interior; Black with gray insert, black with red insert and black with black insert.
- Infinite recline mechanism.

| XHD Off Road Seat | Part # |
|--|----------|
| 84-01 Cherokees, Front Seat, XHD Off Road Seat, Black with Gray Insert NEW | 13448.09 |
| 84-01 Cherokees, Front Seat, XHD Off Road Seat, Black with Black Insert NEW | 13448.15 |
| 84-01 Cherokees, Front Seat, XHD Off Road Seat, Black with Red Insert NEW | 13448.53 |

XHD SIERRA SEAT

- A sport racing design, this seat features a special seat belt harness cutout with a integrated head rest.
- Expanded top and bottom side bolsters cradle the driver in comfort.
- Constructed of durable automotive grade textured vinyl and available in three factory matching colors: Gray, Black Denim, Spice.
- Infinite recline mechanism.

| XHD Sierra Seat | Part # |
|--|----------|
| 84-01 Cherokees, Front Seat, XHD Sierra Seat with Recliner, Gray NEW | 13447.09 |
| 84-01 Cherokees, Front Seat, XHD Sierra Seat with Recliner, Black Denim NEW | 13447.15 |
| 84-01 Cherokees, Front Seat, XHD Sierra Seat with Recliner, Spice NEW | 13447.37 |



SEAT PROTECTORS



Available in Durable Neoprene or Tough UV Treated Poly Cotton

Protect your seats from the elements with these easy to install Seat Protectors. Constructed of durable UV treated poly cotton fabric or soft water resistant neoprene to ensure comfort and protection. Each Seat Protector incorporates extra storage on the rear of the cover plus a removable drink holder. Easy to install, these covers fit over all bucket Jeep® seats including all Rugged Ridge® replacement seats. Sold in pairs to cover your entire front seating area.

Seat Protector

- All Jeeps® Black Fabric, Pair
- All Jeeps® Gray Fabric, Pair
- All Jeeps® Spice Fabric, Pair
- All Jeeps® Black/Gray Neoprene, Pair

Part #

- 13235.01
- 13235.09
- 13235.37
- 13235.19

TRAIL BAGS

Rugged Ridge® has the answer for your onboard storage needs. These soft-side storage bags feature heavy canvas construction and oversized zippers. Great for carrying recovery gear, spare parts, camping gear, clothes, or any other necessity for a wheeling trip. Rugged nylon straps keep the bags in place during even the most insane wheeling. Make the most out of your roll cage with a full complement of Rugged Ridge® storage bags. These bags are easy to install and take off and work with both hard tops and soft tops.



13551.25 Seat Back Trail Bag

Trail Bags

Part #

- | | |
|---------------------------------|----------|
| Seat Back Trail Bag, Detachable | 13551.25 |
| Seat Back Trail Bag | 13551.26 |

SUV/JEEP® STORAGE BAG

Custom designed to provide removable storage for Jeep® vehicles. Special size fits behind rear seat to organize and store your cargo. Constructed of durable vinyl with a zipper top and removable cargo dividers - easy to use shoulder strap included.



Seat Protector

Part #

- | | |
|--|----------|
| Jeep®/SUV Storage Bag, Universal all Jeep® | 13551.01 |
|--|----------|

OFF-ROAD ORGANIZER

Custom design for use in Jeep® glove boxes. Special pockets allow you to effectively organize owners manuals, maps, tire gauges, vehicle registration and more. Constructed of durable nylon in a tri-fold configuration.



Off-Road Organizer

Part #

- | | |
|--------------------------------|----------|
| All Jeep® Glove Boxes/Consoles | 13305.06 |
|--------------------------------|----------|

TOTAL PROTECTION FOR YOUR JEEP®!

Rugged Ridge® All Terrain Floor Liners offer complete interior floor protection for your Truck, SUV or Jeep®. Now you can be assured when Rugged Ridge® All Terrain Floor Liners are installed, your investment is protected for the life of your vehicle. Rugged Ridge® All Terrain Floor Liners are essential for everyday use, at work or when your vehicle is used for outdoor adventures. Keep your vehicle clean and free from harmful airborne contaminants that get in your carpet when going through snow, dust, sand or even when you decide to go play in the mud. Rugged Ridge® has you protected when its necessary to catch the second scoop of your little ones ice cream after the big game. No jobs too big with our 3/8" Deep Tread Technology chevron pattern floor liners, that are up to 3 times the depth of the other floor liners for maximum floor protection. Rugged Ridge® All Terrain Floor Liners are available for domestic and foreign vehicle manufactured applications.



Protects your vehicles interior from whatever nature throws at you!



Deep Treads keep water/snow away from your clothing.



Easy to Clean; simply hose off and go!



Exclusive Self Sealing floor hook attachment keeps moisture out while securing the liner!
[Available on most applications]



12950.15



12975.23

Cherokee 84-12

| YEAR | MAKE/MODEL | Front | Universal Rear | Custom Rear | Cargo Liner | Jeep® Logo Front |
|-------|---------------------------|----------|----------------|-------------|-------------|------------------|
| 84-01 | Cherokee NEW | 12920.25 | 82950.01 | - | - | DMC-12920.25 |
| 93-98 | Grand Cherokee NEW | 12920.26 | 82950.01 | - | - | DMC-12920.26 |
| 99-04 | Grand Cherokee NEW | 12920.27 | 82950.01 | - | - | DMC-12920.27 |
| 05-10 | Grand Cherokee NEW | 12920.28 | 82950.01 | - | - | - |
| 06-09 | Commander NEW | 12920.28 | 82950.01 | - | - | - |
| 07-12 | Compass NEW | 12920.30 | - | 12950.17 | 12975.25 | - |
| 07-12 | Patriot NEW | 12920.30 | - | 12950.17 | 12975.25 | - |
| 08-12 | Liberty NEW | 12920.31 | - | 12950.20 | 12975.27 | - |
| 11-12 | Grand Cherokee NEW | 12920.29 | 82950.01 | 12950.15 | 12975.23 | - |

1. Coming Soon. Available 2012.

ROLL/PITCH INDICATOR

BACK SEAT HEATER



Keep your Jeep® warm in the winter with the Rugged Ridge® Back Seat Heater. This 300 watt, 12 volt heater will warm your vehicle quickly keeping you and your passengers comfortable. Designed to fit on the rear wheel well of any Jeep®, this easy to use heater wires easily to your existing electrical system. Some drilling may be required.

| Back Seat Heater | Part # |
|--------------------|----------|
| All Jeeps® & SUV's | 13150.01 |

Rugged Ridge® offers two styles of Clinometers for those off-road adventures. Each style features two gauges: left displays side by side angle and the right displays front to back angle. Each display has a graphic read out that shows angles in degrees for quick reference. Choose from the Compass model that has a floating compass in the middle or the lighted version for night time use (some wiring required). Each attach to the dash of your Jeep® with automotive grade double sided tape or can be permanently mounted with screws.



13309.01



13309.02

| Clinometer | Part # |
|------------------|----------|
| With compass | 13309.01 |
| With light, Each | 13309.02 |



FLASHLIGHT HOLDERS



11238.06 Flashlight Mounting Brackets

| Flashlight Holders | Part # |
|--|----------|
| Mounting Brackets, for 1.5" Diameter Flashlights, Universal Application, drilling required, Pair | 11238.06 |

BILLET SHIFT KNOBS

Upgrade the look of your Jeep® with a billet aluminum shift knob from Rugged Ridge®. These highly polished shift knobs attach directly to your original equipment shifter with no drilling. Simply unscrew your current knob and replace it with the billet shift knob. There are two styles to choose from: a solid polished version and a shift pattern version. Do not forget to also replace the transfer case knob as well! The combination creates the ultimate look! Please measure your shift/transfer case threads before ordering.



11420.23



11420.20
5-Speed
Shift Knob

11420.04

| Billet Shift Knobs w/ Shift Pattern* | Size | Part # |
|--|--------------------|----------|
| 97-01 Cherokee, 97-98 Grand Cherokee, 5 Speed Manual | 10 mm x 1.5 metric | 11420.20 |
| 84-96 Cherokee, 93-96 Grand Cherokee, 5 Speed Manual | 3/8" - 16 Thread | 11420.22 |
| Billet Shift Knobs w/o Shift Pattern* | Size | Part # |
| 97-01 Cherokee, 97-98 Grand Cherokee, 5 Speed Manual | 10 mm x 1.5 metric | 11420.23 |
| 84-96 Cherokee, 93-96 Grand Cherokee, 5 Speed Manual | 3/8" - 16 Thread | 11420.21 |
| Transfer Case Knob w/ Pattern | Size | Part # |
| 88-01 Cherokee, 93-98 Grand Cherokee, With NP231 | 10 mm x 1.5 metric | 11420.20 |

* NOTE: please measure your gear shift thread size prior to ordering

DUAL CUP HOLDER



| Discription | Part # |
|-------------------------------------|----------|
| 84-01 XJ Cherokee, Black NEW | 12035.50 |



Exterior Accessories

BUG DEFLECTOR



| Rugged Ridge Bug Deflector Shield | Part # |
|--|----------|
| 84-01 Cherokee [XJ], Smoked Acrylic NEW | 11350.10 |
| 93-98 Grand Cherokee [ZJ], Smoked Acrylic NEW | 11350.11 |
| 99-04 Grand Cherokee [WJ], Smoked Acrylic NEW | 11350.12 |
| 05-10 Grand Cherokee [WK], Smoked Acrylic NEW | 11350.13 |
| 02-07 Liberty KJ, Smoked Acrylic NEW | 11350.20 |
| 08-10 Liberty KK, Smoked Acrylic NEW | 11350.21 |

WINDOW RAIN DEFLECTOR

NEW!



| Rugged Ridge Window Rain Deflector | Part # |
|--|----------|
| 84-01 Cherokee [XJ], Front and Rear, Smoked Acrylic NEW | 11351.20 |
| 93-98 Grand Cherokee [ZJ], Front and Rear, Smoked Acrylic NEW | 11351.21 |
| 99-04 Grand Cherokee [WJ], Front and Rear, Smoked Acrylic NEW | 11351.22 |
| 05-10 Grand Cherokee [WK], Front and Rear, Smoked Acrylic NEW | 11351.23 |
| 02-07 Liberty KJ, Front and Rear, Smoked Acrylic NEW | 11351.30 |
| 08-10 Liberty KK, Front and Rear, Smoked Acrylic NEW | 11351.31 |

REAR EURO-GUARDS

| Rear Euro Guards | Steel | Black |
|----------------------------|----------|----------|
| 99-04 Grand Cherokee, Pair | 11103.20 | 11226.20 |
| 05-10 Grand Cherokee, Pair | 11103.21 | 11226.21 |



11226.20



11103.21



[A] 13310.10

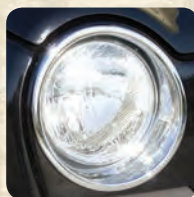

[B] 13310.30



[C] 13310.37

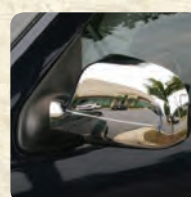

[D] 13310.12



[E] 13310.32



[F] 13310.22



[H] 13310.33

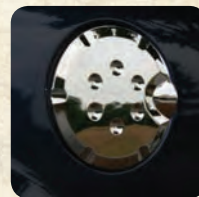

[I] 13310.15

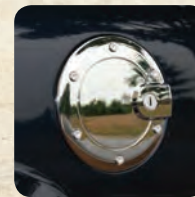

[J] 13310.25



[G] 13310.13



[K] 13310.17



[L] 13310.14



[P] 13310.31



[M] 13310.16



[O] 13310.21



[N] 13310.11

Complete the look of your rig with chrome accessories from Rugged Ridge®. These UV-treated chromed plastic covers attach to your vehicle with durable double sided tape; the same tape used in attaching complete body kits to vehicles! Available in easy to use kits for upgrading your Grand Cherokee and Liberty.

| Chrome Accessories for Jeep® | Part # |
|--|----------|
| A Headlight Trim Covers, Chrome, 99-04 Grand Cherokee, Pair | 13310.10 |
| B Headlight Trim, Chrome, 02-04 Liberty, Pair | 13310.30 |
| C Grille Inserts Chrome, 7 Piece Kit, 02-04 Liberty | 13310.37 |
| D Mirror Covers Chrome, Pair, 99-04 Grand Cherokee | 13310.12 |
| E Mirror Covers Chrome, Pair, 02-04 Liberty | 13310.32 |
| F Mirror Covers Chrome, Pair, 05-07 Grand Cherokee | 13310.22 |
| G Door Handle Covers Chrome, 10 Piece Kit, 99-04 Grand Cherokee | 13310.13 |
| G Door Handle Covers Chrome, 8 Piece Kit, 05-07 Grand Cherokee | 13310.23 |
| H Door Handle Covers Chrome, 10 Piece Kit, 02-04 Liberty | 13310.33 |
| H Door Handle Covers Chrome, 4 Piece Kit, 08-10 Liberty | 13311.13 |
| I Fuel Door Cover Chrome, Each, 99-04 Grand Cherokee | 13310.15 |
| J Fuel Cover Chrome, Each, Grand Cherokee 05-07 | 13310.25 |
| J Fuel Cover Chrome, Each, Liberty 02-04 | 13310.35 |
| K Pillar Trim Chrome, Pair, 99-04 Grand Cherokee | 13310.17 |
| L Lift Gate Hinge Covers Chrome, Each, 99-04 Grand Cherokee | 13310.14 |
| L Lift Gate Hinge Covers Chrome, Each, 05-07 Grand Cherokee | 13310.24 |
| M Lift Gate Accent Trim Chrome, Each, 99-04 Grand Cherokee | 13310.16 |
| M Lift Gate Accent Trim Chrome, Each, 05-07 Grand Cherokee | 13310.26 |
| N Tail Light Trim Covers Chrome, Pair, 99-04 Grand Cherokee | 13310.11 |
| O Tail Light Covers Chrome, Pair, Grand Cherokee 05-07 | 13310.21 |
| P Tail Light Covers Chrome, Pair, 02-04 Liberty | 13310.31 |



**8,500LB LINE SPEED & AMP DRAW-FIRST LAYER
for Wire Cable and Synthetic Rope Winches**

| Line Pull | Lbs | No Load | 2000 | 4000 | 6000 | 8000 | 8500 |
|---------------|--------|---------|------|------|------|------|------|
| Line Speed | Ft/min | 37.2 | 18 | 13.1 | 10.2 | 8.2 | 7.2 |
| Motor Current | amps | 70 | 190 | 260 | 335 | 410 | 425 |



8,500 LB. Heavy Duty Winch with Steel Cable Part #
15100.01

- Durable 6.6 HP Series Wound motor for long life and extra pulling power
- Tough 3 stage planetary gear box with a 218:1 gear ratio delivering power and reliability
- Includes 94' of 23/64" diameter wire rope and latched hook
- Automatic load holding brake system (in the drum brake system)
- Exclusive light mount roller fairlead included- allows for easy no-drill mounting of up to 2 off road lights!
- Tough stainless hardware is used on the body of the winch to eliminate rust
- Each winch includes a durable 12' all weather cable remote solenoid box that can be mounted in multiple positions (over cable or over motor) and angles to accommodate most winch bumpers including the Rugged Ridge® XHD Bumper System!
- Limited 3 year warranty against manufacturing defects

10,500 LB. Heavy Duty Winch with Steel Cable Part #
15100.10



RUGGED RIDGE HEAVY DUTY 8,500 LB WINCH

- Durable 5.5 HP Series Wound motor for long life and extra pulling power
- Tough 3 stage planetary gear box with a 172.8:1 gear ratio delivering power and reliability
- Includes 94' of 5/16" diameter wire rope and latched hook
- Automatic load holding brake system (in the drum brake system)
- Exclusive light mount roller fairlead included- allows for easy no-drill mounting of up to 2 off road lights!
- Tough stainless hardware is used on the body of the winch to eliminate rust
- Each winch includes a durable 12' all weather cable remote solenoid box that can be mounted in multiple positions (over cable or over motor) and angles to accommodate most winch bumpers including the Rugged Ridge® XHD Bumper System!
- Limited 3 year warranty against manufacturing defects

EXCLUSIVE LIGHT MOUNT ROLLER FAIRLEAD INCLUDED WITH BOTH WIRE CABLE WINCHES



RUGGED RIDGE HEAVY DUTY 10,500 LB WINCH

ALL WEATHER 12' CABLE REMOTE INCLUDED WITH ALL WINCHES



**10,500LB LINE SPEED & AMP DRAW-FIRST LAYER
for Wire Cable and Synthetic Rope Winches**

| Line Pull | Lbs | No Load | 2000 | 4000 | 6000 | 8000 | 10500 |
|---------------|--------|---------|------|------|------|------|-------|
| Line Speed | Ft/min | 29.5 | 14.4 | 11.9 | 9.85 | 8.7 | 7.2 |
| Motor Current | amps | 70 | 170 | 240 | 310 | 380 | 425 |

RUGGED RIDGE SYNTHETIC ROPE PERFORMANCE WINCHES!

We have taken the high quality features of our regular winch and replaced the steel cable with genuine Dymeema SK-75 Synthetic Rope for a lighter weight, high performance winch option. The synthetic rope used on Rugged Ridge winches is custom designed for heavy duty use and combined with the included polished aluminum hawse fairlead and 12' hook, will provide the ultimate in pulling power.

Rugged Ridge 8,500 Synthetic Rope Winch- 11/32" x 100', Breaking Force 16,550lbs

- Constructed with Dyneema SK-75 fiber from the Netherlands.
- Same high strength fabric used in ballistic body armor.
- Significantly stronger than same diameter steel cable and up to 40% stronger than Kevlar.
- 1/7 the weight of the same diameter wire rope.
- Will not splinter, kink or curl like wire rope & floats in water.
- Specially coated to be resistant to UV, abrasions, and chemical solvents.
- Heavy Duty 11/32" 12-strand braid with a breaking force of 16,550lbs
- Hawse fairlead included



ALL WEATHER 12' CABLE REMOTE INCLUDED FOR ALL WINCHES

8,500 LB Performance Winch w/ Synthetic Rope Part #
15100.02

Rugged Ridge 10,500 Synthetic Rope Winch-3/8" x 94', Breaking Force 19,310lbs

- Constructed with Dyneema SK-75 fiber from the Netherlands.
- Same high strength fabric used in ballistic body armor.
- Significantly stronger than same diameter steel cable and up to 40% stronger than Kevlar.
- 1/7 the weight of the same diameter wire rope.
- Will not splinter, kink or curl like wire rope & floats in water.
- Specially coated to be resistant to UV, abrasions, and chemical solvents.
- Heavy Duty 3/8" 12-strand braid with a breaking force of 19,310lbs
- Protective sleeves keep line from overheating on winch drum.
- Hawse fairlead included

ALL RUGGED RIDGE SYNTHETIC WINCHES INCLUDE AN ALUMINUM HAWSE FAIRLEAD



10,500 LB Performance Winch w/ Synthetic Rope Part #
15100.11

WHY SYNTHETIC WINCH ROPE?

Stronger and lighter, the two key elements of Synthetic Rope that make it the choice of competition off road vehicles everywhere. Rugged Ridge high strength synthetic Winch Rope is constructed from genuine Dyneema SK-75 fiber imported from the Netherlands. This revolutionary fiber is the choice of off-road enthusiast worldwide. It is stronger and lighter than wire rope and never kinks or splinters! Our synthetic line is woven from twelve UV-treated strands, resulting in increased strength, and a power to weight ratio unmatched by wire rope. Each synthetic rope comes with a protective sleeve that prevents it from over heating on the winch drum, black powder coated latched hook, stainless steel thimble, and is pre-terminated end for ease of installation. Synthetic rope does not store energy like steel cables, and in the event of a failure it is much less likely to result in severe injuries caused by the whiplash of broken wire rope.

- Significantly stronger than same diameter steel cable and up to 40% stronger than Kevlar.
- Same high strength fabric used in ballistic body armor.
- 1/7 the weight of the same diameter wire rope.
- Will not splinter, kink or curl like wire rope & floats in water.
- Protective sleeves keep line from overheating on winch drum.



Synthetic Winch Rope

| | Part # |
|--|----------|
| Synthetic Winch Rope 1 1/32" x 100', Breaking Force of 16,550 lbs, Each NEW | 15102.10 |
| Synthetic Winch Rope 3/8" x 94', Breaking Force of 19,310 lbs, Each NEW | 15102.11 |

WINCH COVER

Keep your winch looking as good as the day you bought it with the Rugged Ridge winch cover. Constructed of durable vinyl with reinforced grommets. Custom fit for Rugged Ridge Winches

Rugged Ridge Winch Cover

| | Part # |
|--|----------|
| Winch Cover, All Rugged Ridge Winches NEW <small>*Will not fit UTV winches</small> | 15102.02 |



ALUMINUM HAWSE FAIRLEAD

This hawse fairlead will help guide the synthetic winch rope to and from the spool. *Required for synthetic rope. Not recommended for steel rope.

Aluminum Hawse Fairlead

| | Part # |
|------------------------------------|----------|
| Aluminum Hawse Fairlead, 10", Each | 11238.01 |



WINCH CABLE HANDLE



15102.01

The winch hook handle is the perfect solution for handling a winch cable. It is constructed of tough nylon webbing with a molded sure-grip handle. Perfect for getting a good solid grip of the winch hook when free spooling cable for a recovery and a safe way to respool your cable without endangering your fingers. Just slip your winch hook through the nylon webbing and you are ready to rock!

Winch Cable Handle

| | Part # |
|-------------------------------------|----------|
| Winch Cable Handle, Each NEW | 15102.01 |

LIGHT MOUNT ROLLER FAIRLEAD

Turn your roller fairlead into an off road light mount! This revolutionary new design allows for two off road lights to be easily mounted while not interfering with the winch operation.

Light Mount Roller Fairlead

| | Part # |
|--|----------|
| Light Mount Roller Fairlead, Each NEW | 11238.03 |



11238.03

ROLLER FAIRLEAD LICENSE PLATE HOLDER

If your state requires a front license plate, we have a solution for you. Instead of drilling holes in your bumper or risking not running a front plate, this easy to install license plate holder attaches to your winch roller fairlead. Simply bolt your license plate to the bracket and snap the holder in place. Your license plate is now securely mounted yet easily removable for winching.

11238.05

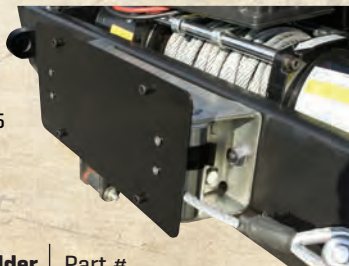

Roller Fairlead License Plate Holder

| | Part # |
|---|----------|
| Roller Fairlead License Plate Holder, Each NEW | 11238.05 |



20,000 lbs Kit

- Durable Recovery Gear Bag.
- Heavy Duty 8" 20,000lb Snatch Block Pulley.
- Premium 2" x 30' 20,000lb Recovery Strap.
- Premium 3" x 6' 30,000lb Tree Trunk Protector Strap.
- Heavy Duty 9,500lb zinc coated pair of D-Rings.
- Winch Line Dampener.
- Pair of Leather Recovery Gloves.

30,000 lbs Kit

- Durable Recovery Gear Bag.
- Heavy Duty 9" 30,000lb Snatch Block Pulley.
- Premium 3" x 30' 30,000lb Recovery Strap.
- Premium 3" x 6' 30,000lb Tree Trunk Protector Strap.
- Heavy Duty 13,500lb zinc coated pair of D-Rings.
- Winch Line Dampener.
- Pair of Leather Recovery Gloves.

Rugged Ridge Recovery Gear Kit

| | Part # |
|--|----------|
| 20,000 lb, Recovery Gear, Kit, Universal Application | 15104.25 |
| 30,000 lb, XHD Recovery Gear Kit, Universal Application NEW | 15104.28 |

The Rugged Ridge Recovery Kit includes everything you need to help your buddy next time he gets stuck in the mud. The durable carrying case is filled with our most popular recovery products to make sure you can get out of those trouble spots quickly and safely. Each kit contains the following:



RECOVERY GEAR

NEW!

Recovery Gear also sold separately.

Don't Need Everything In Our Recovery Kit? Customize Your Your Own And Get Just What You Need!

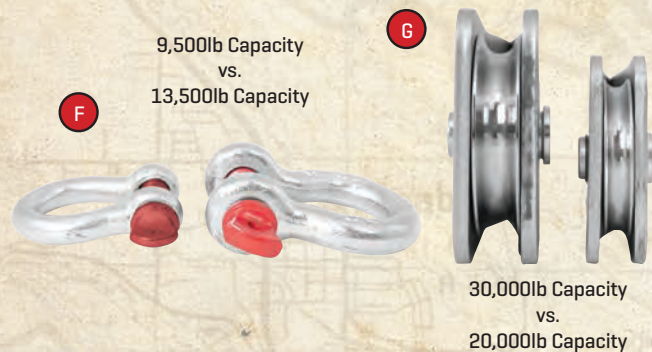

Rugged Ridge Recovery Gear

| | Part # |
|--|----------|
| A Recovery Strap 3" x 30' 30,000 lbs, Each NEW | 15104.01 |
| A Recovery Strap 2" x 30' 20,000 lbs, Each NEW | 15104.02 |
| A Recovery Strap 4" x 30' 40,000 lbs, Each NEW | 15104.03 |
| B Tree Trunk Protector, 3" x 6' 30,000 lbs, Each NEW | 15104.10 |
| B Tree Trunk Protector, 2" x 6' 20,000 lbs, Each NEW | 15104.11 |
| C Recovery Bag, Each NEW | 15104.40 |
| D Recovery Gloves, Pair NEW | 15104.41 |
| E Winch Line Dampener, Each NEW | 15104.43 |
| F Heavy Duty 9,500 lb Zinc Coated D-Rings, Pair NEW | 11235.01 |
| F Heavy Duty 13,500 lb Zinc Coated D-Rings, Pair NEW | 11235.03 |
| G Heavy Duty 8" 20,000 lb Snatch Block Pulley, Each NEW | 11235.10 |
| G Heavy Duty 9" 30,000 lb Snatch Block Pulley, Each NEW | 11235.11 |

The Rugged Ridge Tire Repair Kit is essential recovery gear for any road or trailside tire repair. The kit includes: 2 sturdy aluminum handles, 2 reamers, 2 needles, 2 Allen head wrenches, and 25 self vulcanizing tire plugs all self contained in a heavy duty storage case. Be prepared for what ever the trail throws at you!

Rugged Ridge Tire Repair Kit

| | Part # |
|----------------------------------|----------|
| Tire Repair Kit, Each NEW | 15104.51 |



TIRE REPAIR KIT

Fully inflated tires are great for the road and gas mileage, but they deliver a washboard ride on the trail. Air down your tires for a softer ride and more tread grip. Rugged Ridge offers two great kits to fit your lifestyle and budget. Made from 100% brass and are fully adjustable in 3 psi. increments. Once you find your desired setting you can lock the deflators where they bleed to the same tire pressure each and every time they are installed. So, you can deflate your tires quickly before heading out on the trail.

Rugged Ridge Adjustable Tire Deflator Kit

| | Part # |
|------------------------|----------|
| 4 Piece Kit NEW | 15104.53 |

ADJUSTABLE TIRE DEFLATOR KIT



The Rugged Ridge Tri Fold Recovery Shovel is a fully functional collapsible shovel that features two serrated edges for cutting or digging. The heavy duty black powder coated body is 23 inches when open and folds to a mere 9 inches. It can be stowed easily in any vehicle, but is still rugged enough for the toughest of jobs. Includes durable storage case.

Rugged Ridge Tri Fold Off Road Shovel

| | Part # |
|---|----------|
| Tri Fold Off Road Shovel, Each NEW | 15104.42 |

Fully inflated tires are great for the road and gas mileage, but they deliver a washboard ride on the trail. Air down your tires for a softer ride and more tread grip. The Tire Deflator Kit includes 4 tire deflators that will allow you to easily deflate your tires before heading out on the trail. All pieces connect together onto a key chain for ease.

Rugged Ridge Tire Deflator Kit

| | Part # |
|-----------------------------|----------|
| Tire Deflator Kit, 4 Pieces | 15104.50 |

KEYCHAIN-TIRE DEFLATOR KIT

TRI FOLD RECOVERY SHOVEL



HID & Halogen Lighting

HID LIGHTING

We mated the brilliance of High Intensity Discharge bulbs with the rugged construction of our traditional halogen off road lights. The result is more efficient and powerful beam better capable of illuminating the night sky. HID lights are 2½ times more powerful than halogen lights and draw 60% less current than a standard 100W fog light. Our 6" and 5" HID Lights are constructed with heavy duty stamped steel housings, and are available in corrosion resistant black or stainless steel finish. Rugged Ridge® lights feature waterproof connections, internal ballast, and a reinforced multi-directional mounting base. The lights are available individually or in kits containing a pre-terminated wiring harness, relay, impact resistant stone guards and illuminated dash switch.

- 5", 6", 7" HID light assemblies available.
- 12V 35W 4200K HID Bulb.
- Internal ballast - no external ignition ballast to install.
- 2½ times more powerful than halogen bulbs.
- Draws 60% less current than a standard 100W fog light.
- HID Lights include impact resistant stone guard.
- The average life of an HID bulb is 2000 hours, compared to 500-1000 hours for a halogen unit.



Lights are available individually.
All include impact resistant stone guards



Kits include a pre-terminated wiring harness, relay and illuminated dash switch



15205.51



15206.01



15205.63

| HID Off Road Lighting | Single Light | 2 Light Kit w/ Wiring Harness | 3 Light Kit w/ Wiring Harness |
|--------------------------|--------------|-------------------------------|-------------------------------|
| 6" Round, Black | 15205.01 | 15205.51 | 15205.61 |
| 5" Round, Black | 15205.02 | 15205.52 | 15205.62 |
| 7" Round, Black, Plastic | 15205.03 | 15205.53 | 15205.63 |
| 5" Round, Black, Plastic | 15205.04 | 15205.54 | 15205.64 |
| 6" Round, Stainless | 15206.01 | 15206.51 | 15206.61 |
| 5" Round, Stainless | 15206.02 | 15206.52 | 15206.62 |

HALOGEN LIGHTING

Designed, engineered, and tested to stand up to the rigors of off road use, our lights are constructed with heavy-duty stamped steel housings, and crystal glass lenses set in shock absorbent weatherproof rubber gaskets. The brilliant 12V 100 watt halogen bulbs slice through fog, rain or snow to help illuminate the road even under the toughest conditions. Available in Round, Rectangular and Slim housings in either a black or stainless steel finish to best suit your application. Slim lights feature a narrow profile just 2 13/16" thick! This sleek design allows them to be mounted in places most lights won't fit. They are perfect for windshield and grille mount light systems. The lights are available individually or in kits containing a pre-terminated wiring harness, relay, impact resistant stone guards [white stone guards with stainless, black with black] and illuminated dash switch.



15207.51

| Rugged Ridge® Off Road Lights, 100W | Single Light | 2 Light Kit w/ Wiring Harness | 3 Light Kit w/ Wiring Harness |
|-------------------------------------|--------------|-------------------------------|-------------------------------|
| 6" Round, Black | 15207.01 | 15207.51 | 15207.61 |
| 5" x 7", Black | 15207.05 | 15207.55 | 15207.65 |
| 6" Slim, Black | 15207.10 | 15207.58 | 15207.68 |
| 6" Round, Stainless | 15208.01 | 15208.51 | 15208.61 |
| 6" Slim, Stainless | 15208.10 | 15208.58 | 15208.68 |



Slim lights feature a narrow profile - just 2 13/16" thick!

Rectangular lights give your vehicle a whole new look

| Halogen Light Accessories | Part # |
|---|----------|
| Off Road Light Cover, 6-Inch Black | 15210.53 |
| Off Road Light Cover, 6-Inch White | 15210.54 |
| Off Road Light Cover, 5x7-Inch Black | 15210.55 |
| Off Road Light Cover, 5x7-Inch White | 15210.56 |
| Off Road Light Cover, 6-Inch Black Slim | 15210.57 |
| Off Road Light Cover, 6-Inch White Slim | 15210.58 |
| Off Road Light Installation Harness, For Pair Of Lights | 15210.62 |
| Off Road Light Installation Harness, For Three Lights | 15210.63 |
| Halogen H3 Off Road Light Bulb, 100w Replacement | 15210.82 |
| Halogen H3 Off Road Light Bulb, 130w Replacement | 15210.83 |

Crystal glass lenses set in shock absorbent weatherproof rubber gaskets.



Each lights includes an impact resistant stone guard.

Multi-directional mounting base allows you to focus light where you need it the most.

HID LIGHT ACCESSORIES

DON'T LET NIGHT FALL ON YOUR ADVENTURE.
 CREATE YOUR OWN DAYLIGHT LONG AFTER THE SUN HAS GONE DOWN!

STANDARD HEADLIGHTS
 LOWER LIGHT OUTPUT IDEAL FOR CITY DRIVING

VS.

BUMPER MOUNTED HID LIGHTS
 EXTREME OUTPUT TO LIGHT UP THE TRAILS

| Accessories/Replacement Parts | Part # |
|--|----------|
| HID Lighting Covers, 7",Smoked | 15210.51 |
| HID Lighting Covers, 6",Black | 15210.50 |
| HID Lighting Covers, 5",Black | 15210.52 |
| HID Lighting Installation Harness for a pair of lights | 15210.60 |
| HID Lighting Installation Harness for three lights | 15210.61 |
| Replacement HID Bulb for 5" and 6" lights | 15210.80 |
| Replacement HID Bulb for 7" lights | 15210.81 |



ROCKER PANEL SWITCHES



- Rocker Style Switch.
- Heavy Duty Marine Grade surpasses OE Specifications.
- Available in four great colors: Red, Blue, Green and Amber.
- Switch illuminated in the "ON" Position.
- Three post terminal, 20-amp design works with most aftermarket accessories.

| Rocker Panel Switches | Part # |
|-----------------------|----------|
| Rocker Switch Amber | 17235.01 |
| Rocker Switch Red | 17235.02 |
| Rocker Switch Blue | 17235.03 |
| Rocker Switch Green | 17235.04 |

ROCKER SWITCH HOUSING KIT



This housing kit allows you to mount 2, 3, or 4 switches to numerous dash locations by using a series of interlocking interchangeable pods.

| Rocker Switch Housing Kit | Part # |
|---------------------------|----------|
| Mounts 2,3 OR 4 Switches | 17235.20 |

| Rocker Switch Pods | Part # |
|---|----------|
| Rocker Switch Housing Kit, Universal Application. Includes Four Interlocking Switch Housings and Four Different Color Rocker Switches | 17235.89 |

CRYSTAL HB2/H4 CONVERSION HEADLIGHT



Replace your old sealed beam bulb headlights with these Crystal H4 Conversion Headlights. This two-piece headlight and bulb is brighter, more economical and environmentally friendly than a conventional sealed beam headlight. The headlights and bulbs are SAE / DOT compliant.

| Crystal HB2/H4 Headlight | Part # |
|---|----------|
| 200mm Rectangular, H2 Bulb, Cherokee 84-01 and Various Non Jeep Applications, Pair, Includes Bulbs NEW | 12402.82 |

HEAVY-DUTY STEERING BOX BRACE

Heavy-duty design supports your steering box during those offroad adventures. Easy to install bolt on design.



HD Steering Box Brace Part #

| | |
|----------------|----------|
| 84-01 Cherokee | 18021.05 |
|----------------|----------|

HEAVY-DUTY STEERING KITS & COMPONENTS

18050.82



Heavy Duty Crossover steering systems prevent "bump steer"!

Heavy-Duty Kits

| Part # | Description |
|----------|--|
| 18050.82 | Complete Heavy-Duty Crossover Steering Conversion Kit [Includes 4 Tie Rod Ends & Steering Dampener Bracket] 84-01 Cherokee (w/under 4" lift), 93-98 Grand Cherokee [6 Cylinder only] |

Heavy-Duty Steering Components

| Part # | Description |
|----------|--|
| 18050.51 | Heavy-Duty Tie Rod [Includes 2 Tie Rod Ends] 84-01 Cherokee 93-98 Grand Cherokee [6 Cylinder Only], all with stock steering linkage only, not for use with kit #18050.82, Each |

| Part # | Description |
|----------|--|
| 18040.50 | Heavy-Duty Tie Rod Steering Dampner Bracket [for use in kit #18050.82], Each |

Heavy-Duty Tie Rod Ends

| Part # | Description |
|----------|---|
| 18043.10 | Heavy-Duty Tie Rod End 7/8", Left Hand Thread, Each |
| 18043.26 | Heavy-Duty Tie Rod End 7/8" Right Hand Thread, Each |
| 18043.27 | Heavy-Duty Tie Rod End With Drag Link Connection, 7/8" Left Hand Thread, Each |

HEAVY-DUTY DIFFERENTIAL COVERS

Indestructible! You won't break these covers, we guarantee it. Made of 3/8" cast steel, painted black inside and out, these heavy-duty covers are designed to protect your differential and all its working parts for as long as you own your vehicle. These indestructible covers have been "44 caliber tested" - if they can take a bullet at point blank range [don't try this at home!], they can take all that the trail has to offer. Available for most popular Dana differential types and include extra reinforcement protection for the fill plug area. All mounting hardware and instructions are included for easy of installation.

Differential Cover

| Part # | Description |
|----------|---------------|
| 16595.30 | Dana 30, Each |
| 16595.35 | Dana 35, Each |
| 16595.44 | Dana 44, Each |



HEAVY-DUTY DIFFERENTIAL SKID PLATES

Differential Cover

| Part # | Description |
|--------------|--|
| 16597.30 | Dana 30 Diff. Skid Plate |
| DMC-16597.30 | Dana 30 Diff. Skid Plate with Jeep® Logo |
| 16597.35 | Dana 35 Diff. Skid Plate |
| DMC-16597.35 | Dana 35 Diff. Skid Plate with Jeep® Logo |
| 16597.44 | Dana 44 Diff. Skid Plate |
| DMC-16597.44 | Dana 44 Diff. Skid Plate with Jeep® Logo |



OFFICIAL LICENSED PRODUCT

MOPAR, JEEP, DODGE, HEMI, PLYMOUTH, RAM, and CHRYSLER vehicles, images and logos are trademarks of Chrysler Group LLC used under license to Omix-Ada®. © Chrysler Group LLC 2011

FRONT ADJUSTABLE TRACK BAR & FRAME STIFFENER

The Adjustable Track Bar's function is to properly locate and center the front axle under the body of your Jeep® and improve its handling capabilities and steering geometry. This kit is designed to correct misalignment that can develop with Jeeps® with 4" of lift. Our track bar tubes are constructed with 1.25" OD x.25" wall DOM tubing. The bar is powder coated black to prevent corrosion and includes: polyurethane bushings, heavy duty mounting bracket and features a 7/8" zinc plated rod end. For the ultimate in front-end rigidity add on our Frame Stiffener #12035.51. This piece ties the front frame rails together while bracing the track bar mount. It is specifically designed for use with the Adjustable Track Bar [#18205.05] only.

18205.20 Track Bar/ Frame Stiffener Kit



Front Adjustable Track Bar and Frame Stiffener

| Part # | Description |
|----------|---|
| 18205.05 | Front Adjustable Track Bar, 84-01 Cherokee XJ, 93-98 Grand Cherokee * |
| 12035.51 | Frame Stiffener, 84-01 Cherokee XJ, 93-98 Grand Cherokee ** |
| 18205.20 | Track Bar/Frame Stiffener Kit [consists of 18205.05 & 12035.51] |

* For use with 4" & over lifts
** Can only be installed in conjunction with P/N 18205.05

HEAVY-DUTY TRANSFER CASE CROSSMEMBER

Heavy-Duty Transfer Case Crossmember

| Part # | Description |
|----------|----------------------------|
| 12035.60 | 84-01 Jeep® Cherokee, Each |

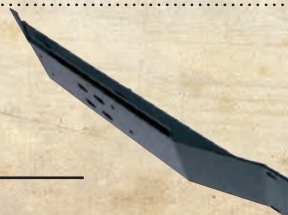

HEAVY-DUTY TOW HOOK KITS

Don't get your Cherokee or Grand Cherokee stuck on trails without a Rugged Ridge® Heavy-duty XJ or ZJ Tow Kit on the front. The 1/4 inch thick steel plate is form bent for maximum strength then powder coated for protection from the elements.

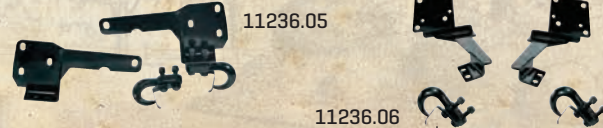

Heavy-Duty Tow Hooks

| Part # | Description |
|----------|-------------------------------|
| 11236.05 | 84-01 Cherokee XJ, Pair |
| 11236.06 | 93-98 Grand Cherokee WJ, Pair |

HOOD LIFT KITS

Eliminate the factory prop rod with a pair of gas charged hood lifts. This kit includes all the brackets and gas shocks needed to clean up the underhood appearance of your Cherokee. This kit is also functional as the hood prop rod will no longer be in the way while working underneath the hood of your XJ. Easy installation.

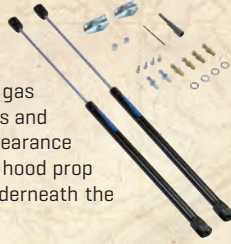

| Description | Part # |
|--|----------|
| Hood Lift Kit XJ Cherokee 84-01 NEW | 11252.52 |
| Hood Lift Service Replacement Shock XJ Cherokee 84-01 NEW | 11252.82 |

TRANSFER CASE SLIP YOKE ELIMINATOR KIT

18676.72 Mega Short Slip Yoke Eliminator Kit



| Transfer Case Slip Yoke Eliminator Kit | Part # |
|--|----------|
| 88-01 Cherokee Slip Yoke Eliminator (with NP231 transfer case) *, Kit | 18676.60 |
| 88-01 Cherokee Mega Short Slip Yoke Eliminator with Vehicle Speed Sensor (with NP231 transfer case) *, Kit | 18676.72 |
| Replacement Bearing for Mega Short Slip Yoke Eliminator Kit #18676.70 | 18676.74 |

*CV style drive shaft is required when using this conversion kit.



11237.10 Lockable Spare Tire Mount Bike Carrier

LOCKABLE SPARE TIRE MOUNT BIKE CARRIER

This easy-to-use bike rack mounts to any emergency tire mounting studs. The bike rack carries 2 bikes directly off the spare tire. It is constructed of 2" powder coated steel tubing for maximum rust protection and durability. The bike clamp feature rubber pads to protect your bike's finish. The carrier comes with 2 keys for the locking mechanism. Fits wheel off sets from 2-5/8" to 6". For All Jeep® Outside Spare Tire Applications

| Bike Carrier | Part # |
|-------------------------------|----------|
| Spare Tire Mount Bike Carrier | 11237.10 |

RECEIVER TOW HOOK



Heavy-duty black powder coated tow hook inserts into any 2" style hitch (does not include hitch pin, not designed for towing).

| Receiver Tow Hook | Part # |
|-----------------------|----------|
| Fits All 2" Receivers | 11237.01 |

RECEIVER HITCH EXTENDER

Constructed from solid steel the extender lengthens your 2" receiver up to 12 inches! [Hitch mount accessories only - not tow rated]

| Receiver Hitch Extender | Part # |
|-------------------------|--------|
|-------------------------|--------|

12" Receiver Hitch Extension, For 2" Hitch, Black Powder Coated



2" RECEIVER HITCH

Includes clip and pin. Ball not included. For Jeep® use only. 2000-lb two rating, 200-lb tongue weight rating.

| Ball Mount Receiver Hitch | Part # |
|---------------------------|--------|
|---------------------------|--------|

2" Square



RECEIVER SHACKLE BRACKET

This heavy-duty steel design fits into any 2" receiver box. It is rated up to 9,500 lbs. pulling capacity on evenly distributed straight pulls. NOTE: never exceed your receiver capacity. Not designed for towing. Does not include hitch pin.

| Receiver Shackle Bracket | Part # |
|--------------------------|----------|
| All 2" Receivers | 11234.01 |



HITCH BALL

Hitch Ball includes a matching mounting nut and lock washer. Pick from two standard sizes.

| Hitch Ball Kit | Part # |
|----------------|--------|
|----------------|--------|

2" x 3/4"

1-7/8" x 3/4"



COLD AIR INTAKES FOR JEEP®

Want more horsepower, better throttle response, and improved acceleration?

A Rugged Ridge® Cold Air Intake System can boost your performance, while helping you keep extra cash in your wallet. Our polished aluminum mandrel bent intake tube replaces the restrictive factory air box to help improve fuel economy. A black powder coated heat shield separates the filter from engine heat, dirt and debris, as cold air is drawn through a high-flow conical air filter. Unlike other reusable air filters, our dry panel design never needs oiling, which keeps your mass airflow sensor from being damaged by excess oil! The simple bolt on installation gives you power you can feel, adding up to 10HP and 12ft lbs or torque, depending on application.

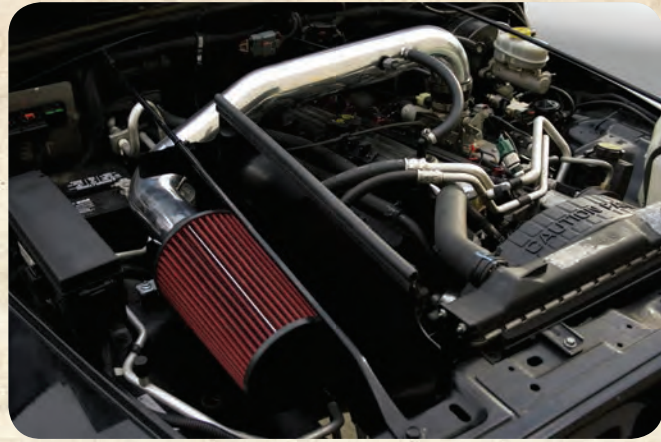

- Polished mandrel bent 6063 aluminum air intake tube.
- Simple no-drill installation bolts on using simple hand tools.
- Includes a high-flow conical dry panel filter that never needs oiling.
- Intake kit includes black powder coated heat shield
- Improves fuel economy up to 10%*
- Adds up to 10HP and 12ft lbs or torque**

Rugged Ridge Cold Air Intake Systems | Part #

| | |
|--------------------------------------|----------|
| 1991-01 XJ Cherokee 4.0L | 17750.20 |
| 1993-98 ZJ Grand Cherokee 5.2L, 5.9L | 17750.22 |

*See <http://www.fueleconomy.gov/feg/maintain.shtm>
 ** Depending on kit

Cherokee 84-12

RUGGED RIDGE HEADERS



17650.01



17650.51



| Application: | Steel | Black | 409 Stainless | 304 Stainless |
|---|----------|----------|---------------|---------------|
| 91-99 Cherokee, 93-98 Grand Cherokee w/ 4.0L Engine | 17660.01 | 17651.01 | 17650.01 | 17650.51 |
| 00-01 Cherokee, 99-01 Grand Cherokee w/ 4.0L Engine | 17660.02 | 17651.02 | 17650.02 | 17650.52 |

THROTTLE BODY SPACER

The Rugged Ridge® Throttle Body Spacer raises the throttle body 1" above the intake manifold. The lift helps optimize power and performance by drawing in colder denser air. The large bore design allows your system to inhale a larger volume of air producing more horsepower and torque. It features solid aluminum construction with a slick anodized black finish, and is a bolt on performance adder for both 4.0L and 2.5L engines.

- Solid Aluminum Construction.
- Simple no-drill installation bolts on using simple hand tools.
- Includes mounting hardware, gaskets and spacers.
- Black Anodized Finish.



Throttle Body Spacer | Part #

| | |
|---------------------------------------|----------|
| XJ Cherokee 1991-01 4.0L & 91-00 2.5L | 17755.01 |
|---------------------------------------|----------|

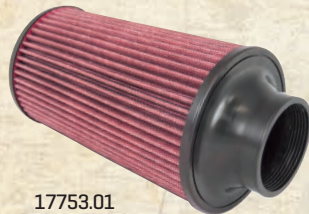

17753.01

CONICAL AIR FILTER

Conical Air Filter

Conical Air Filter, Synthetic, for Cold Air Kit 17750.03 and 17750.20, 70MM Flange, 270MM Length **NEW**

Part #

17753.02

SYNTHETIC AIR FILTER

Unlike other reusable air filters, our dry panel design never needs oiling, which keeps your mass airflow sensor from being damaged by excess oil! Rugged Ridge® performance high flow filters are made from a synthetic fabric and not cotton. Cotton filters are made porous and must be oiled to trap dirt and debris. But that oil reduces air flow through the filter and it can become easily clogged. Our filters are woven from synthetic fabric to allow maximum air flow and particulate filtration. Because our filters never need oiling, they can be cleaned easily with water instead of degreaser, reducing the cost of maintaining the filter over the lifetime of your vehicle.

No oil = No fuss, no mess and improved performance!

Air Filter | Part #

| | |
|--|----------|
| Air Filter, Synthetic, XJ 87-96 2.5L, 4.0L NEW | 17752.06 |
| Air Filter, Synthetic, XJ 97-01 2.5L, 4.0L NEW | 17752.07 |
| Air Filter, Synthetic, ZJ 93-98 V8 5.2L, 5.9L NEW | 17752.08 |
| Air Filter, Synthetic, WJ 99-04 4.0L, 4.7L NEW | 17752.09 |
| Air Filter, Synthetic, KJ 02-07, 3.7L NEW | 17752.10 |



17752.09

Designed by a dedicated team of Jeep® enthusiasts, the ORV™ suspension program is one of the most complete programs available. We have looked at each application in detail to provide the very best and most complete solution for your Jeep®. Since we focus the large majority of our attention on Jeep® vehicles, we know the ins and outs of what the best lift solution is depending on your individual needs. Below is a quick reference guide on the ORV™ program to make it easier to choose the lift you need for your particular need. Remember, all ORV™ Kits with shocks include a pair of neoprene wrapped grab handles and an Off Road Organizer for your glove box!

Welcome to ORV™ by Rugged Ridge®!



Ken W.
Katterbach, Germany



Brian H.
Lansdale, PA



Dave G.
Flowery Branch, GA

A FEW WORDS ABOUT PRODUCT SAFETY.

Your safety and the safety of other motorists is very important. Your Jeep® is an off road capable vehicle that readily lends itself to restoration and customization. In considering modifications to your Jeep's® suspension you are the person choosing the combination of suspension, wheels, tires, drive train and accessories that best fit your intended use. Likewise, you are the person responsible for the safety and legality of the vehicle you modify. In modifying your vehicle's suspension, balance your desired off road capabilities against how the vehicle may actually be used off road and on road.

It is not practical or possible to warn about all hazards associated with your Jeep® or modifying your suspension for improved off road capabilities. Start by familiarizing yourself with all vehicle manufacturers' instructions, warnings limited warranties and the instructions and warnings accompanying your aftermarket product.

To help you make informed decisions about safety; this catalog and the instructions accompanying our products have provided certain information in the form of "Notices" and "Warnings". This information alerts you to potential hazards that could hurt you or others.

NOTICE This is a caution against anything which may cause damage to the vehicle or its equipment if the caution is ignored. The Notice includes information about how you can avoid or reduce those risks.

WARNING This is a signal telling you that you CAN BE KILLED or SERIOUSLY HURT if you don't follow the Warning. The Warning includes information about what you must or must not do in order to reduce the risk of injury to yourself and others.

CAUTION This is a signal telling you that you or others CAN BE HURT if you don't follow the instruction. The Caution includes information about how you can avoid those risks.

WARNING HIGHER ROLLOVER RISK

Modifying the suspension of your vehicle to improve off road capabilities involves certain risks. The modified vehicle may handle differently than as factory equipped including increased ride-height; reduced lateral stability and risk of roll-over or other accident. Also, owner's choice of larger tire and wheel combinations may require additional braking force or increased stopping distances.

- Failure to drive this vehicle safely may result in serious injury or damage. Avoid sharp turns or abrupt maneuvers. Do not drive the vehicle under any speed or maneuvering conditions which may cause the vehicle to trip, roll, lose traction or compromise your ability to safely brake in an emergency.
- Familiarize yourself with all vehicle manufacturers and Rugged Ridge® warnings, instructions and limited warranties before driving this modified suspension vehicle. Follow recommended maintenance procedures and routinely inspect your vehicle components for unusual wear or off road damage.
- Rugged Ridge® does not recommend combined use of body lifts with suspension or other lift devices or modification, alteration or fabrication of any Rugged Ridge® suspension product to achieve additional lift. Also be aware that most states have restrictions on height modifications for vehicles used on road. Consult your vehicle owners manual, limited warranties, the instructions and warnings accompanying this product and state law before undertaking these modifications or using your modified suspension vehicle on road. A summary of current regulations affecting modified suspension vehicles is available from www.SEMA.org.
- Always wear seat belts and/or appropriate off road restraints, reduce your speed, tread lightly® and safely enjoy your off road vehicle.

Know your Kits: Though there are many ways to provide extra lift for your Jeep®, ORV™ recommends the following lift options as the best way to Lift your Jeep®:

Poly Spacer Kits: Available for Coil Spring 99-04 Jeep® Grand Cherokees

Coil Spring Kits: Available for 93-98 Jeep® Grand Cherokees and 84-01 Jeep® Cherokees

LIFT OPTIONS EXPLAINED:

• **Poly Spacer Kits** - Used for small lifts, these low cost lifts are designed for on road/light off road use only and incorporate the factory coil springs. With the addition of spacers, the ride of your Jeep® will be stiffer than original and provides very little articulation when off road. Bump stops (also called blocks) should always be a part of the kit as you will be using the factory springs. This method of lifting is the low cost/lower performance solution to lifting your Jeep® vehicle.

• **Coil Lift Kits** - Used for medium to large lifts, these lifts are designed for on road and moderate to severe off road use. Coil Spring kits provide the best way to give extra lift and still maintain OE ride characteristics. The 2" - 4" kits should offer new springs and extended bump stops as listed above as well as rear track bar bracket/brace to ensure proper centering of the axle and a secure fit.

POLY SPACER KITS



Coil spring spacers are made from high density polyurethane.

COIL SPRING KITS



All ORV™ springs are constructed of 5160H hot rolled bar, keeps its memory so the spring will not sag.

All ORV™ springs are set to original factory rates. Provides a better ride both on and off road.

All ORV™ coil springs are powder coated, E-coated 5/8" coil for long life and strength.



18415.80 Poly Spacer Kit

POLY BUSHINGS



All bushings are made from high density injection molded Polyurethane.



18401.75 Coil Lift Kit

BRACKET/BRACES



Beefy powder coated stamped steel brackets include grade 5 hardware.

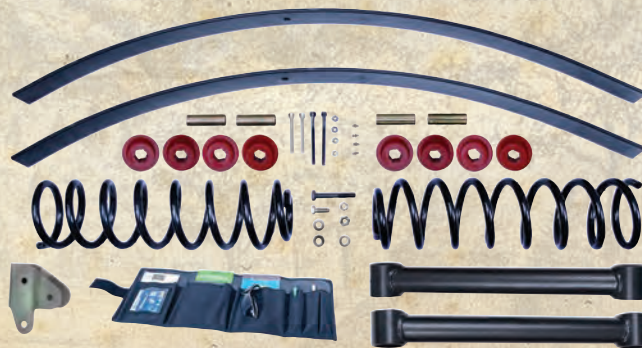

18401.70 Leaf Spring Kit

ORV™ SHOCKS

ORV™ only uses nitrogen charged gas shocks for all their kits. Though a little more money, the nitro gas shock in combination with the ORV™ kits provide a better ride both on and off road. By using an ORV™ lift kit and matching gas shocks, you optimize the suspension's capabilities giving you a better ride both on and off road. Another advantage to Nitro gas shocks is their ability to prevent body roll.

ORV™ SHOCK FEATURES INCLUDE:

- 150 PSI pressurized Nitrogen gas
- Internal valving - the internal orifice will rotate when the piston moves more than 2" - automatically adjusts to make the ride as smooth as possible
- Twin tube construction to lower heat build up and protect the shock from off road obstacles
- Constructed to ORV™ specifications by a leading Shock manufacturer
- Bonded Iron 14mm piston with extra chroming - provides for a longer, rust free life
- Includes polyurethane bushings and a black shock boot
- Limited lifetime warranty on the shocks

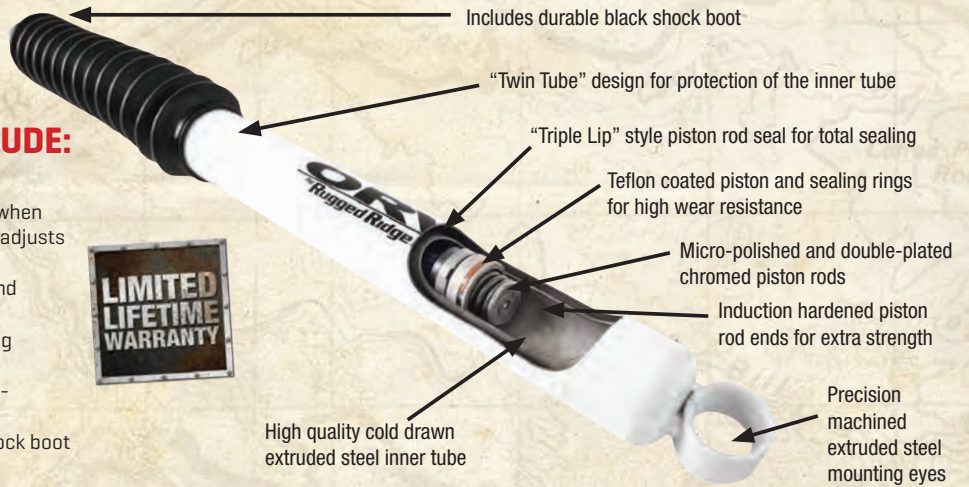

| ORV™ Shocks | Front | Extended | Collapsed | Rear | Extended | Collapsed |
|--|----------|----------|-----------|----------|----------|-----------|
| ORV Nitrogen Series Shock, 84-01 Jeep® Cherokee XJ, 3" Lift | 18465.05 | 22.75" | 13.54" | 18465.06 | 22.58" | 13.71" |
| ORV Nitrogen Series Shock, 93-98 Jeep® Grand Cherokee ZJ 3" Lift | 18465.05 | 22.75" | 13.54" | 18465.02 | 22.58" | 13.71" |
| ORV Nitrogen Series Shock, 99-04 Jeep® Grand Cherokee WJ 2" Lift | 18465.05 | 22.75" | 13.54" | 18465.13 | 24.84" | 14.82" |



ORV™ STEERING STABILIZERS

Add a splash of color to your rig with colored shock boots from Rugged Ridge®. These durable shock boots keep mud and debris from prematurely ruining your shocks and they look great too! Works on ORV™ Nitrogen Shocks and most other brands as well! Sold each.

| ORV™ Steering Stabilizers | Part# |
|---|----------|
| Shock Boot, Black, ORV Suspension, Universal Application NEW | 18479.50 |
| Shock Boot, Red, ORV Suspension, Universal Application NEW | 18479.51 |
| Shock Boot, Blue, ORV Suspension, Universal Application NEW | 18479.52 |

ORV™ STEERING STABILIZERS

ORV™ recommends upgrading your current steering stabilizer or adding a stabilizer on all lifted Jeep® vehicles. The ORV™ Steering stabilizer dampens out the roughness of the highway and the vibration from running larger tires and wheels. ORV™ Hydraulic Stabilizers also make it easier to move those larger tires and wheels both on and off road. These noticeable handling improvements are well worth the small investment!

| ORV™ Steering Stabilizers | Part# |
|---|----------|
| ORV Hydraulic Series Steering Stabilizer, 84-01 Jeep® Cherokee XJ | 18475.02 |
| ORV Hydraulic Series Steering Stabilizer, 93-98 Jeep® Grand Cherokee ZJ | 18475.02 |



Lifting a vehicle takes more than just slapping on taller springs. The stock steering linkage is designed for use with the stock height suspension. The steering linkage angles of a lifted vehicle are more extreme and influenced by suspension travel. This drop pitman arm helps reduce the angle of your drag link and reduce bumpsteer created when a suspension lift is installed.

| Drop Pitman Arms | Part # |
|--|----------|
| 93-98 Grand Cherokee w/Power Steering, 4"-8" of Lift | 18006.54 |
| 84-01 Cherokee w/Power Steering, 4"-8" of Lift | 18006.54 |

DROP PITMAN ARMS

18006.50



WARNING: WARNING: Look at the beginning of the ORV™ section for important safety information.

1984-01 CHEROKEE

84-01 Jeep Cherokee XJ 3" Lift

- Custom designed add-a-leaf springs with polyurethane bushings for a soft ride & easy installation.
- Tough powder coat finished [E-coated pre finish] U-bolts.
- Kit also includes 2 lower links and front track bar bracket.
ORV™ kits with shocks include an Off Road Organizer!

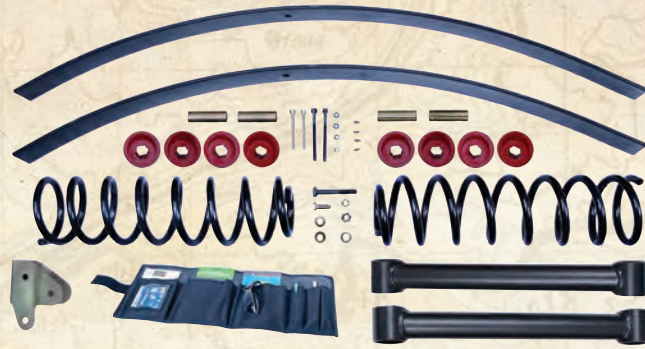

18401.70 Lift Kit, 3" 1984-01 Cherokee

| 84-01 Jeep® Cherokee XJ, 4WD/2WD | Kit w/o Shocks | Kit w/ Shocks | Max Tire Size- HxWxD | Max Wheel Offset | Estimated Install Time |
|--|----------------|---------------|----------------------|------------------|------------------------|
| 3" Lift, 84-01 Jeep® Cherokee, 2WD/4WD** | 18401.70 | 18415.70 | 31"x10.5"x15" | 3.75" | 6 Hours |

**Add-A-Leaf Rear
18401.70 Kit includes: [2] front coil springs, [2] rear add-a-leaf springs

WARNING: WARNING: Look at the beginning of the ORV™ section for important safety information.

1993-98 GRAND CHEROKEE

93-98 Jeep Grand Cherokee 3" Coil Spring Lifts

- Custom designed coil springs for a soft ride, great on road performance.
- Kit includes standard links with urethane bushings for a great ride and long life.
- Also includes front track bar bracket.
- ORV™ kits with shocks include an Off Road Organizer!



18401.75 Lift Kit, 3" 1993-98 Grand Cherokee

| 93-98 Jeep® Grand Cherokee ZJ, 4WD/2WD | Kit w/o Shocks | Kit w/ Shocks | Max Tire Size- HxWxD | Max Wheel Offset | Estimated Install Time |
|---|----------------|---------------|----------------------|------------------|------------------------|
| 3" Lift, 93-98 Jeep® Grand Cherokee, 2WD/4WD | 18401.75 | 18415.75 | 31"x10.5"x15" | 3.75" | 8 Hours |

18401.75 Kit includes: (4) coil springs, (4) lower links, front track bar bracket, hardware kit
WARNING: WARNING: Look at the beginning of the ORV™ section for important safety information.

1999-04 GRAND CHEROKEE

99-04 Jeep Grand Cherokee 2" Poly Spacer Lift

- Custom Spacer kit that gives you a more aggressive look while providing great on road performance.
- Kit includes 4 polyurethane spacers and all necessary installation hardware.
- ORV™ kits with shocks include an Off Road Organizer!
- Bump stops are not required on this kit.



18415.80

| 99-04 Jeep® Grand Cherokee WJ, 4WD/2WD | Kit w/o Shocks | Kit w/ Shocks | Max Tire Size- HxWxD | Max Wheel Offset | Estimated Install Time |
|--|----------------|---------------|----------------------|------------------|------------------------|
| 2" Poly Spacer Lift, 99-04 Jeep® Grand Cherokee, 2WD/4WD | 18401.80 | 18415.80 | 31"x10.5"x16" | 3.75" | 4 Hours |

18401.80 Kit includes: (2) front coil spacers, (2) rear coil spacers
WARNING: WARNING: Look at the beginning of the ORV™ section for important safety information.

Cherokee 84-12



POLYURETHANE/SUSPENSION ACCESSORIES



COMPLETE POLYURETHANE KIT

(includes all major suspension points for steel bodied models. Not for fiberglass bodies):

| Description | Poly # | Replaced by Omix # |
|-------------------|--------|--------------------|
| 84-01 XJ Cherokee | 1-2004 | 18350.04 |

REAR SPRING & SHACKLE BUSHING KITS:

| Description | Poly # | Replaced by Omix # |
|-------------------|--------|--------------------|
| 84-01 XJ Cherokee | 1-1007 | 18365.02 |

SHACKLE BUSHING KITS:

| Description | Poly # | Replaced by Omix # |
|-------------------|--------|--------------------|
| 84-01 XJ Cherokee | 1-804 | 18366.04 |



SWAYBAR BUSHING KITS:

| Description | Poly # | Replaced by Omix # |
|--|--------|--------------------|
| 1984-01 XJ Cherokee, 1993-98 ZJ Grand Cherokee 24mm, FRONT | 1-1103 | 18367.03 |
| 1984-01 XJ Cherokee, 1993-98 ZJ Grand Cherokee 25mm, FRONT | 1-1104 | 18367.04 |
| 1984-01 XJ Cherokee, 1993-98 ZJ Grand Cherokee 28mm, FRONT | 1-1105 | 18367.05 |
| 1984-01 XJ Cherokee, 1993-98 ZJ Grand Cherokee 23mm, FRONT | 1-1106 | 18367.06 |
| 1984-01 XJ Cherokee, 1993-98 ZJ Grand Cherokee 1", FRONT | 1-1108 | 18367.08 |
| 1984-01 XJ Cherokee, 1993-98 ZJ Grand Cherokee 7/8", FRONT | 1-1115 | 18367.13 |
| 1984-01 XJ Cherokee, 1993-98 ZJ Grand Cherokee 15/16", FRONT | 1-1116 | 18367.14 |
| 1984-01 XJ Cherokee, 1993-98 ZJ Grand Cherokee 1-1/8", FRONT | 1-1117 | 18367.15 |
| 1984-01 XJ Cherokee, 5/8" BAR, REAR | 1-1118 | 18367.16 |
| 1993-98 ZJ Grand Cherokee, REAR | 1-1109 | 18367.09 |

MISC. POLYURETHANE ITEMS:

| Description | Poly # | Replaced by Omix # |
|---|---------|--------------------|
| 87-01 XJ Cherokee 4.0L Engine Mount Pair | 1-502 | 18390.02 |
| Jack Handle Grabber (Anti-Rattle), All Hi Lift Style Jacks NEW | 19-1404 | 18369.50 |
| 1984-01 Cherokee, Sway Bar Disconnect Eye Bushing NEW | - | 18366.80 |
| Shock Bushing, Rubber, Universal NEW Application, 1-7/16 Long, 5/8 Id, 1-In OD | - | 18367.20 |

POLYURETHANE/STAINLESS BRAKE LINES

TRACK ARM BUSHING KITS:

| Description | Poly # | Replaced by Omix # |
|----------------------------------|--------|--------------------|
| 1984-01 XJ Cherokee, Front | 1-1203 | 18368.02 |
| 1993-98 ZJ Grand Cherokee, Front | 1-1203 | 18368.02 |
| 1993-98 ZJ Grand Cherokee, Rear | 1-1204 | 18368.03 |

CONTROL ARM BUSHING KITS:

| Description | Poly # | Replaced by Omix # |
|----------------------------------|--------|--------------------|
| 1984-01 XJ Cherokee, Front | 1-202 | 18368.01 |
| 1993-98 ZJ Grand Cherokee, Front | 1-203 | 18368.02 |
| 1993-98 ZJ Grand Cherokee, Rear | 1-301 | 18362.04 |

FRONT & REAR BRAIDED STAINLESS STEEL BRAKE HOSES:

(PROVIDES UP TO 4" EXTRA LENGTH. ESSENTIAL FOR LIFTED VEHICLES)



| Description | Part # |
|--|----------|
| 1992-01 Cherokee 4WD Kit [3-Piece Front & Rear] | 16735.09 |
| 1993-98 Grand Cherokee w/ Rear Drum Kit [3 Line] | 16735.10 |
| 1993-98 Grand Cherokee w/ Rear Disc Kit [5 Line] | 16735.11 |



ORV™ SUSPENSION SYSTEMS BY RUGGED RIDGE® LIMITED LIFETIME WARRANTY

Your Omix-Ada® / Rugged Ridge® product is covered by the Lifetime Limited Warranty explained below that gives you specific legal rights. This limited warranty is the only warranty Omix-Ada® / Rugged Ridge® / ORV™ makes in connection with your product purchase. Parts sold by Omix-Ada® or Rugged Ridge® but supplied by other vendors are exclusively warranted by the vendor supplying the part. Omix-Ada® neither assumes nor authorizes any vendor, retailer or other person or entity to assume for it any other obligation or liability in connection with this product or Limited Warranty.

What is covered? Subject to the terms, exclusions and limitations herein and with respect only to products first sold in the United States, Omix-Ada® warrants to the initial retail purchaser only that its Rugged Ridge® suspension kits, and ORV™ shocks and stabilizers shall be free of defects in material and workmanship for so long as the initial retail purchaser owns the vehicle on which these products were originally installed. All other express or implied warranties are hereby disclaimed. Your warrantor for these parts is Omix-Ada®, Inc., 460 Horizon Dr., Suite 400 Suwanee, GA 30024. Omix-Ada® reserves the rights to: [a.] require proof of purchase as a condition of this Limited Warranty, [b.] make future revisions to its Limited Warranty without prior notice.

What is not covered? Your Omix-Ada® / Rugged Ridge® / ORV™ Limited Warranty does not cover any Rugged Ridge® / ORV™ suspension systems that are used or combined with non-ORV™ suspension components. Furthermore, ORV™ suspensions not installed with ORV™ or other recommended shock absorbers may void the Limited Warranty. Products that wear out or fail due to the use of larger tires or wheels are not covered by this Limited Warranty. Your Omix-Ada® Limited Warranty further does not cover products or parts supplied to Omix-Ada® by outside vendors or products, parts or vehicles Omix-Ada® determines to have been damaged by or subjected to:

- Installation damage, alteration, modification or failure to maintain.
- Normal wear and tear [bushings, tie-rod ends, etc.]. Scratches or defects in product finishes [powder coating, plating, etc.] or damage due to shipping.
- Damage arising or related to non- Omix-Ada® / Rugged Ridge® / ORV™, including but not limited to any vehicle's electronic stability system, related components or other vehicle systems.
- Racing or other vehicle competitions or contests. Accidents, impact by rocks, trees, obstacles or other aspects of the environment.
- Theft, vandalism or other intentional damage.
- Products used in application other than those recommended in the current / Rugged Ridge® / ORV™ catalog or the instructions accompanying your Rugged Ridge® /ORV™ product.

Remedy Limited to Repair / Replacement. The exclusive remedy provided hereunder shall, upon Omix-Ada® inspection and at Omix-Ada's® option, be either repair or replacement of product or parts covered under this Limited Warranty. Customers requesting warranty consideration on Omix-Ada® branded parts (including Rugged Ridge® and ORV™) should first contact the independent distributor from whom you purchased your part to obtain a Returned Goods Authorization number. All removal, shipping and installation costs are customer's responsibility. Customers requesting warranty consideration on non-Omix-Ada® branded parts should refer to the manufacturers' Limited Warranty and contact them directly. If a replacement part is needed before the Omix-Ada® part can be returned, you must first purchase the replacement part. Then, if Omix-Ada® deems the part warrantable, you will be credited the purchase price.

Other Limitations - Exclusion of Damages - Your Rights Under State Law

- In consideration of the purchase price paid, neither Omix-Ada® nor any independent Omix-Ada® distributor/licensee are responsible for any time loss, rental costs, or for any incidental, consequential, punitive or other damages you may have or incur in connection with any part or product purchased. Your exclusive remedy hereunder for covered parts is repair/replacement as described above.
- This Limited Warranty gives you specific rights. You may also have other rights that vary from state to state. For example, while all implied warranties are disclaimed herein, any implied warranty required by law is limited to the terms of Limited Warranty described above. Some states do not allow limitations of how long an implied warranty lasts and /or do not allow the exclusion or limitation of incidental or consequential damages, so the limitations and exclusions herein may not apply to you.



DRIVETRAIN ENGINEERING PERFECTED

Are you looking for an axle or ring and pinion rugged enough to match your off the beaten path sense of adventure? Alloy USA® axle shafts and Precision Gear® ring & pinions have been propelling muscle cars, trucks and four wheel drive vehicles down highways, drag strips, back roads and over the world's roughest terrain for nearly a decade. With the recent asset and intellectual property purchase of Alloy USA® and Precision Gear® by Ultra Axle LLC, an affiliate of Omix-Ada® Inc., these two brands are now backed by an industry leading, financially strong company that will be there for you in the long haul. As a member of the Omix-Ada® group of companies Alloy USA® and Precision Gear® will provide the service and support you demand!



The dedicated team of Alloy USA® and Precision Gear® engineers have developed, tested, raced and trail ridden each of our products until they were perfected. We marry the mechanics of engineering with the art of manufacturing to produce the finest in drivetrain solutions. High tensile strength 4340 Chromoly is heat-treated, tempered and induction hardened to produce these heavy-duty axles that are up to 40% stronger than stock. We use the latest splining technology to produce splines that are stronger than traditional cut splines. The shafts are then precision CNC machined and magnaflux inspected for cracks before receiving the Alloy USA® logo and a slick black anodized or natural finish.

Why have we put so much time and energy into developing our Axle Shafts and Ring & Pinions? Because horsepower is useless if you can't get it to the ground. We take pride in engineering solutions and prove it by backing each product with an industry leading warranty. Each axle is covered by our exclusive 10-year limited warranty and each ring and pinion is covered by a 5-year limited warranty so you can drive with confidence!

THE BEST WARRANTY IN THE BUSINESS

Alloy USA®/Precision Gear® Limited Warranty

Your Alloy USA® or Precision Gear® product is covered by the Limited Warranty explained below that gives you specific legal rights. This limited warranty is the only warranty Ultra Axle® LLC [the distributor/warrantor of these products] makes in connection with your purchase. Ultra Axle® LLC neither assumes nor authorizes any vendor, retailer or other person or entity to assume for it any other obligation or liability in connection with its products or Limited Warranty.

What is covered? Subject to the terms, exclusions and limitations herein and with respect only to products first sold in the United States, Ultra Axle® LLC warrants to the initial retail purchaser only that products sold under its Alloy USA® and Precision Gear® trademarks including Axle Shafts, Ring and Pinions, Installation Kits, Jeep® Overhaul Kits, Alloy USA® X Joints and Differential Covers shall be free of defects in material and workmanship for the Limited Warranty term/duration described below. This Limited Warranty shall be measured from the date of initial retail purchase, extends only to the initial retail purchaser and is not transferable. All other express or implied warranties are hereby disclaimed. Your warrantor for these parts is Ultra Axle® LLC, 460 Horizon Dr., Suite 400 Suwanee, GA 30024 [770-614-6101]. Ultra Axle® reserves the right to: [a.] require proof of purchase as a condition of this Limited Warranty, [b.] make future revisions to its Limited Warranty without prior notice.

Duration of Limited Warranty by Product Line

Alloy USA®, front and rear axles- **10 Year Limited Warranty**

Precision Gear® and Alloy USA® Ring and Pinions- **5 Year Limited Warranty**

Jeep® Overhaul kits, Alloy USA® X Joints, Tube Seals, Differential Covers, Differential Cable Lock Kits, Wheel Spacers, Transfer Chain Kits, Yoke Conversion Kits & Hub Conversion Components - **3 Year Limited Warranty**

What is not covered: Your Alloy USA®, Precision Gear® Limited Warranty does not cover damage or claims to any component, vehicle or person other than Alloy USA® or Precision Gear® parts purchased by the initial retail purchaser. Your Alloy USA®, Precision Gear® Limited Warranty does not cover damage or claims to any component, vehicle or person Ultra Axle® LLC determines to have been damaged by or subjected to:

- Installation damage, alteration, modification, misuse or failure to maintain.
- Products used in application other than those recommended in the current Alloy USA®/Precision Gear® catalog or the instructions accompanying your Alloy USA® Precision Gear® product.
- Normal wear and tear/product life deterioration, scratches or defects in product finishes [powder coating, plating, etc.] or damage due to shipping.
- Damage arising or related to non- Ultra Axle® LLC products including but not limited to any vehicle's electronic stability system, related components or other vehicle systems.
- Accidents, impact by rocks, trees, obstacles or other aspects of the use environment.
- Theft, vandalism or other intentional damage.

Remedy Limited to Repair / Replacement. The exclusive remedy provided hereunder shall, upon Ultra Axle® LLC inspection and at Ultra Axle® LLC option, be either repair or replacement of the Ultra Axle® LLC parts covered under this Limited Warranty. Customers requesting warranty consideration should first contact the independent distributor selling your part to obtain a Returned Goods Authorization number. All removal, shipping and installation costs are customer's responsibility. If a replacement part is needed before the Ultra Axle® LLC part can be returned, you must first purchase the replacement part. Then, if Ultra Axle® LLC determines the part warrantable, you will be credited the purchase price of that part.

Other Limitations - Exclusion of Damages - Your Rights Under State Law

- In consideration of the purchase price paid, neither Ultra Axle® LLC nor any independent distributor are responsible for any loss of use or time, rental costs, or for any incidental, consequential, punitive or other damages you may have or incur in connection with your vehicle or any Ultra Axle® LLC product. Your exclusive remedy for Ultra Axle® LLC parts covered hereunder is repair/replacement as described above.
- This Limited Warranty gives you specific rights. You may also have other rights that vary from state to state. For example, while all implied warranties are disclaimed herein, any implied warranty required by law is limited to the duration and other enforceable terms of Limited Warranty described above. Some states do not allow limitations of how long an implied warranty lasts and /or do not allow the exclusion or limitation of incidental or consequential damages, so the limitations and exclusions herein may not apply to you.

© Ultra Axle® LLC Ultra Axle LLC. 1.3.2010. All Rights Reserved. Jeep® is a registered trademark of Chrysler LLC. Ultra Axle® LLC is an independent aftermarket vendor not affiliated with any vehicle manufacturer. Pro Gear® and Ultralite Gears and Differentials® are additional trademarks of Ultra Axle® LLC.



Chrysler®, Chevrolet®, Dodge®, GM®, Ford®, Jeep®, International® & other names used here are trademarks of their respective owners and are used within this publication for identification purposes only. Alloy USA® is not affiliated with these companies. The information in this catalog is believed to be correct at the time of publishing. The publisher is not responsible for any losses, direct or indirect, that are the result of any information within this publication. Alloy USA® and Precision Gear® and their corresponding logos are trademarks of Ultra Axle®, LLC. OMIX-ADA® and its corresponding logo are registered trademarks of OMIX-ADA®, Inc.

®Registered 2010, Ultra Axle®, LLC. all rights reserved.

Alloy USA® Front Axles & Front/Rear Shafts



FRONT AXLE KITS

High tensile strength 4340 Chromoly is heat-treated, tempered and induction hardened to produce these heavy-duty axles that are up to 40% stronger than stock 1040 axles. Each axle shaft is backed by Alloy USA®'s exclusive ten-year warranty! We use the latest splining technology to produce splines that are stronger than traditional cut splines. The shafts are then precision CNC machined and magnaflux inspected for cracks before receiving a slick black anodized finish. Our front axle shaft kits include everything you need to complete the job: both passenger and drive side inner and outer axle shafts, seals, U-joints and clips.

JEEP® COMPLETE INNERS/OUTERS WITH U-JOINTS & CLIPS

Cherokee 84-12

| Application | Part # | Inner | Outer | Ring |
|--|-----------|-------|-------|------|
| Jeep Cherokee [XJ] 84-91, Dana 30 27-Spline Kit [Disconnect Eliminator] | 12145 | 27 | 27 | D30 |
| Jeep Cherokee [XJ] 84-91, Dana 30 30-Spline Kit | 12131 | 30 | 27 | D30 |
| Jeep Cherokee [XJ] 84-91, Dana 30 30-Spline Kit w/ARB Locker , 3.73 & Up | 12131-ARB | 30 | 27 | D30 |
| Jeep Cherokee [XJ] 84-91, Dana 30 Grande 30/30-Spline Kit [30-Spline Inners & Outers] | 12231 | 30 | 30 | D30 |
| Jeep Cherokee [XJ] 84-91, Dana 30 Grande 30/30-Spline Kit w/ ARB Locker [30-Spline Inners & Outers] ² , 3.73 & Up | 12231-ARB | 30 | 30 | D30 |
| Jeep Cherokee [XJ] 92-01, Dana 30 27-Spline Kit | 12148 | 27 | 27 | D30 |
| Jeep Cherokee [XJ] 92-01, Dana 30 Grande 30-Spline Kit ³ | 12132 | 30 | 27 | D30 |
| Jeep Cherokee [XJ] 92-01, Dana 30 Grande 30-Spline Kit w/ ARB Locker, 3.73 & Up | 12132-ARB | 30 | 27 | D30 |
| Jeep Cherokee [XJ] 92-01, Dana 30 Grande 30/30-Spline Kit [30-Spline Inners & Outers] ^{1,2,3} | 12232 | 30 | 30 | D30 |
| Jeep Cherokee [XJ] 92-01, Dana 30 Grande 30/30-Spline Kit w/ ARB Locker [30-Spline Inners & Outers] ^{1,2} , 3.73 & Up | 12232-ARB | 30 | 30 | D30 |
| Jeep Wagoneer [SJ] 74-79, Dana 44 30-Spline Kit NEW | 12171 | 30 | 19 | D44 |
| Jeep Wagoneer [SJ] 80-92, Dana 44 30-Spline Kit NEW | 12174 | 30 | 19 | D44 |

¹ NOTE: This kit includes upgraded 30 spline bearing hub units.

² NOTE: When converting to 30 spline outer axles, 1999 and older models must use the 2000-06 Wrangler rotor [Omix 16702.05].

³ NOTE: Upgrade to 30 spline locker required.

GRANDE OUTER STUB UPGRADE

Grande 30 spline outer stub upgrade replaces factory 27 spline outer stub axles to 30 spline.

Kit includes:

- 2 - 30 Spline Chromoly Axle Stub Shafts
- 2 - 30 Spline Unit Bearings
- 2 - Alloy X-Joints



| Application | Part # |
|--|--------|
| Jeep Cherokee [XJ] 84-01, 30-Spline Outer/Unit Bearing Upgrade Kit | 12168 |

NOTE: When converting to 30 spline outer axles, 1999 and older models must use the 2000-06 Wrangler brake rotor [Omix 16702.05].

ALLOY USA® DANA 30 MANUAL LOCKING HUB CONVERSION KITS

The Alloy USA® Hub Conversion Kit is designed to upgrade and replace the non-serviceable wheel hubs found on 1984-01 Cherokees. Now you can lock and unlock your front hubs to reduce driveline strain and improve fuel economy! The Deluxe Hub Conversion kit includes a set of Rugged Ridge® Manual Locking Hubs, high tensile strength 27 spline inner and outer Alloy USA® 4340 Chromoly Axle Shafts, 1/2 ton capacity aluminum internal mounting hubs, Alloy USA® X-Joints, machined front brake rotors, bearings, seals and hardware.... everything you need to upgrade your rig and prepare it for the trail. Maximum recommended tire size is 33".

Alloy USA® Grande Hub Conversion Kits Feature:

- Better fuel economy by freewheeling in 2WD mode. Decreases tire wear since unlocked manual hubs rotate more freely.
- Includes beefy Corrosion resistant die cast aluminum Rugged Ridge® Manual Locking Hubs.



| Deluxe Hub Conversion with Alloy USA® Inner & Outer Axles | Part # |
|--|----------|
| 84-01 XJ, D30 Manual Locking Hub Deluxe Conversion Kit, Includes Alloy USA® Inner Axle Shafts NEW | 12198 |
| Standard Hub Conversion without Inner Shafts | |
| 84-91 Cherokee [XJ], D30 Manual Locking Hub Conversion Kit NEW | 12194 |
| 92-01 Cherokee [XJ], D30 Manual Locking Hub Conversion Kit NEW | 12195 |
| Service Rotor Brake For Front Hub Conversion | |
| 84-01 Cherokee [XJ] NEW | 16702.13 |



PERFORMANCE REAR AXLE KITS FOR JEEP®

High tensile strength 4140 Chromoly is heat-treated, tempered and induction hardened to produce these heavy-duty axles that are up to 35% stronger than stock 1040 axles. Alloy USA® uses the latest cold rolled splining technology, to produce splines that are stronger than traditional cut splines. Our shafts are covered by an exclusive 10-year warranty! Rear axle shaft kits include everything you need for your installation: both passenger and drive side shafts, seals, bearings and wheel studs. Upgraded spline counts for Jeep® applications: Dana 35 spline upgrades from 27 splines to 30 splines. Dana 44 spline upgrades from 30 splines to 33 and 35 splines.



Jeep® 2 Axles - Bearings - Seals - Wheel Studs

| | Part # | Spline | Ring |
|--|-----------|--------|------|
| Jeep Cherokee [XJ] 84-89, Dana 35 Grande 30-Spline Kit, [Non C-clip] ¹ | 12133 | 30 | D35 |
| Jeep Cherokee [XJ] 84-89, Dana 35 Grande 30-Spline Kit With ARB Locker [Non C-clip], 3.54 & Up | 12133-ARB | 30 | D35 |
| Jeep Cherokee [XJ] 84-89, Dana 35 Grande 30-Spline Kit With Detroit Locker [Non C-clip], 3.54 & Up | 12133-DET | 30 | D35 |
| Jeep Cherokee [XJ] 90-01, Dana 35 27-Spline Kit, [C-clip, Without ABS] | 12200 | 27 | D35 |
| Jeep Cherokee [XJ] 90-01, Dana 35 Grande 30-Spline Kit, [C-clip, Without ABS] ¹ | 12134 | 30 | D35 |
| Jeep Cherokee [XJ] 90-01, Dana 35 Grande 30-Spline Kit With ARB Locker, [C-clip, Without ABS], 3.54 & Up | 12134-ARB | 30 | D35 |
| Jeep Cherokee [XJ] 90-01, Dana 35 Grande 30-Spline Kit With Detroit Locker, [C-clip, Without ABS], 3.54 & Up | 12134-DET | 30 | D35 |
| Jeep Grand Cherokee [ZJ] 94-98, Dana 35 27-Spline Kit NEW | 12201 | 27 | D35 |
| Jeep Grand Cherokee [ZJ] 94-98, Dana 44 30-Spline Kit | 12202 | 30 | D44 |

¹ NOTE: Upgrade to 30 spline locker required.

Rule #1: If it broke it needed to be upgraded. For less than the cost of an original replacement axle shaft you can upgrade to an Alloy USA® performance shaft. Each axle is heat-treated, tempered and induction hardened to have twice the tensile strength than stock and is up to 35% stronger. We use the latest splining technology, to produce splines that are stronger than traditional cut splines.

PERFORMANCE REAR AXLE SHAFTS



**Jeep® Axle Shafts, Sold Individually.
Wheel Bearings, Seals, & Wheels Studs Available Separately**

| | Part # | Hollander | Spline | Length | Side | Ring |
|--|--------|-----------|--------|----------|-------|-------|
| Jeep Cherokee [XJ] 84-89, Dana 35, RH, 27-Spline w/o ABS | 21136 | 1799R | 27 | 28.94" | RH | D35 |
| Jeep Cherokee [XJ] 84-89, Dana 35, LH, 27-Spline w/o ABS | 21137 | 1799L | 27 | 30.35" | LH | D35 |
| Jeep Cherokee [XJ] 90-91, Dana 35, RH, 27-Spline w/ ABS | 21138 | NA | 27 | 29.04" | RH | D35 |
| Jeep Cherokee [XJ] 90-91, Dana 35, LH, 27-Spline w/ ABS | 21139 | NA | 27 | 30.54" | LH | D35 |
| Jeep Cherokee [XJ] 92-01, Dana 35, RH, 27-Spline w/o ABS | 21120 | 1797R | 27 | 29-1/16" | RH | D35 |
| Jeep Cherokee [XJ] 92-01, Dana 35, LH, 27-Spline w/o ABS | 21121 | 1797L | 27 | 30-9/16" | LH | D35 |
| Jeep Cherokee [XJ] 92-01 Dana 35, RH, 27-Spline w/ ABS & Drum | 21140 | 1832R | 27 | 29" | RH | D35 |
| Jeep Cherokee [XJ] 92-01 Dana 35, LH, 27-Spline w/ ABS & Drum | 21141 | 1832L | 27 | 30-5/8" | LH | D35 |
| Jeep Cherokee [XJ] 91-96, LH/RH, Chrysler 8.25", 27-Spline | 21116 | 1831 | 27 | 29-3/4" | LH/RH | 8.25" |
| Jeep Cherokee [XJ] 97-01, LH/RH, Chrysler 8.25", 29-Spline | 21118 | 2235 | 29 | 29-3/4" | LH/RH | 8.25" |
| Jeep Grand Cherokee [ZJ] 94-98, Dana 35, RH, 27-Spline, w/ ABS & Rear Disc Brakes NEW | 21122 | 2081R | 27 | 29-1/8" | RH | D35 |
| Jeep Grand Cherokee [ZJ] 94-98, Dana 35, LH, 27-Spline, w/ ABS & Rear Disc Brakes NEW | 21123 | 2081L | 27 | 30-9/16" | LH | D35 |
| Jeep Grand Cherokee [ZJ] 94-98, Dana 44, RH, 30-Spline, w/ ABS & Rear Disc Brakes NEW | 21124 | 2232R | 30 | 29-1/4" | RH | D44 |
| Jeep Grand Cherokee [ZJ] 94-98, Dana 44, LH, 30-Spline, w/ ABS & Rear Disc Brakes NEW | 21125 | 2232L | 30 | 30-1/4" | LH | D44 |
| Jeep Grand Cherokee [WJ] 99-04, Dana 35, RH, 27-Spline NEW | 21126 | 2461 | 27 | 30-1/4" | RH | D35 |
| Jeep Grand Cherokee [WJ] 99-04, Dana 35, LH, 27-Spline NEW | 21127 | 2462 | 27 | 31-7/8" | LH | D35 |
| Jeep Grand Cherokee [WJ] 99-04, Dana 44, RH, 30-Spline NEW | 21128 | 2703R | 30 | 29-3/8" | RH | D44 |
| Jeep Grand Cherokee [WJ] 99-04, Dana 44, LH, 30-Spline NEW | 21129 | 2703L | 30 | 32-3/8" | LH | D44 |

Alloy USA®

JEEP® RING & PINIONS

NEW!



These affordable high strength gear sets come in all the popular ratios to satisfy everyone's gearing needs. Oversized tires require higher ring & pinion ratios to restore performance. Made from high quality 8620 forgings and Gleason gear cutting technology, these gears are made to last. Complete installation kits are available separately to complete the job. Exclusive 5-year warranty. Available in 3.73, 4.10, 4.56, 4.88 and 5.13 ratios.

| Application | Ratio | Part # |
|--|-------|----------|
| FRONT | | |
| Cherokee [XJ] 84-91, Dana 30 Reverse, 3.73 Ratio | 3.73 | D30373R |
| Cherokee [XJ] 84-91, Dana 30 Reverse, 4.10 Ratio | 4.10 | D30410R |
| Cherokee [XJ] 84-91, Dana 30 Reverse, 4.56 Ratio | 4.56 | D30456R |
| Cherokee [XJ] 84-91, Dana 30 Reverse, 4.88 Ratio | 4.88 | D30488R |
| Cherokee [XJ] 92-01, Dana 30, 4.56 Ratio (Short) | 4.56 | D30456TJ |
| Cherokee [XJ] 92-01, Dana 30 4.88 Ratio (Short) | 4.88 | D30488TJ |
| REAR | | |
| Cherokee [XJ] 84-01, Dana 35 Rear, 3.73 Ratio | 3.73 | D35373 |
| Cherokee [XJ] 84-01, Dana 35 Rear, 4.10 Ratio | 4.10 | D35410 |
| Cherokee [XJ] 84-01, Dana 35 Rear, 4.56 Ratio | 4.56 | D35456 |
| Cherokee [XJ] 84-01, Dana 35, 4.88 Ratio | 4.88 | D35488 |
| Cherokee [XJ] 91-01, Chrysler 8.25", 3.55 Ratio NEW | 3.55 | C83355 |

RING & PINION MASTER INSTALLATION & OVERHAUL KITS FOR JEEP®

These great kits offer all the components you will need to complete your differential rebuild or ring & pinion installation. Complete with bearings, pinion seals, pinion shims, crush sleeve, pinion nut, ring gear bolts and marking compound.



| Application | Part # |
|--|--------|
| Cherokee [XJ] 84-91, Dana 30 Front | 352032 |
| Cherokee [XJ] 84-01, Dana 35 Rear | 352049 |
| Cherokee [XJ] 92-01, Dana 30 Front | 352031 |
| Grand Cherokee [WJ] 99-04, Dana 35, Rear | 352061 |
| Grand Cherokee [WJ] 99-00, Before 3/29/00, Dana 44, Rear | 352062 |
| Grand Cherokee [WJ] 00-04, After 3/29/00, Dana 44, Rear | 352063 |
| Grand Cherokee [XJ] 91-01, Chrysler 8.25, Rear | 352064 |
| Grand Cherokee [ZJ] 93-98, Dana 35 Rear | 352049 |
| Grand Cherokee [ZJ] 93-98, Dana 30 Front | 352031 |

Cherokee 84-12

WHEEL SPACERS & ADAPTERS

- Moves your wheels out to help fit wider tires-creates extra stability.
- Hub centric design to assure wheel balance.
- Constructed of durable 6061T6 aluminum for long life, extra strength and corrosion resistance.
- Available in 1.25" to 1.5" widths for today's most popular wheel sizes.
- Each pair includes pre-installed grade 8 wheel studs, 10 lug nuts and thread locker.
- Wheel adaptors convert current bolt patterns to alternate bolt patterns for use with different wheels.
- Wheel Spacers and Wheel adaptors are sold in pairs.

NEW!



| Wheel Spacers | Width | Bolt Pattern | Part # |
|------------------------------------|-------|--------------|--------|
| Jeep Cherokee 1984-2001 NEW | 1.25" | 5 on 4.5" | 11301 |

| Wheel Adapters | Width | Conversion | Part # |
|-------------------------------------|-------|------------------------|--------|
| Cherokee 1984-2001, Pair NEW | 1.25" | 5 on 4.5" to 5 on 5.5" | 11310 |

HD DIFFERENTIAL COVERS

Indestructible! You won't break these covers, we guarantee it. Made from either 3/8" cast steel or 5/16" stamped steel, painted black inside and out, these heavy-duty covers are designed to protect your differential and all its working parts for as long as you own your vehicle. These indestructible covers have been ".44 caliber tested" - if they can take a bullet at point blank range (don't try this at home!), they can take all that the trail has to offer. Available for most popular Dana differential types and include extra reinforcement protection for the fill plug area. All mounting hardware and instructions are included for ease of installation.

| Differential Cover | Cast 3/8" Steel | Stamped 5/16" Steel | Price |
|--------------------|-----------------|---------------------|-------|
| HD Dana 30 | 11206 | 11200 | |
| HD Dana 35 | 11201 | - | |
| HD Dana 44 | 11202 | - | |

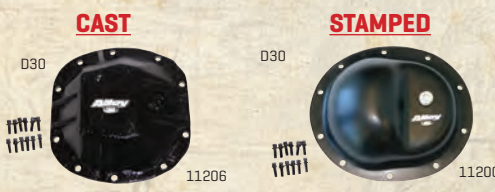

SLOTTED BRAKE ROTORS

Alloy USA® slotted & drilled brake rotors improve braking performance right out of the box. Slotted & drilled for maximum cooling! Slotted rotors improve brake pad bite & reduce brake fade.



NEW!

| Application | Part # |
|--|--------|
| 1990-1999 Cherokee (4WD Only), Disc Brake Rotor (Front) NEW | 11350 |
| 2000-2001 Cherokee, Disc Brake Rotor (Front) NEW | 11351 |
| 2002-2007 Liberty, Disc Brake Rotor (Rear) NEW | 11352 |

ALLOY USA® FRONT AXLE X-JOINT COLD FORGED · SERVICEABLE

Now a serviceable U-joint for Dana 44 applications is available to you. Replace your 760X U-joint with Alloy USA's new X-joint!



| Application | Part # |
|--|--------|
| Heavy Duty Alloy X-joint, Complete U-joint With Bearings (760 Style) Replaces 5-297X/5-760X NEW | 11500 |

YOKE CONVERSION KITS

These great Conversion Kits allow you to convert your old strap style yoke to the newer stronger u-bolt design. Not only it the U-bolt kit stronger, it makes changing out a failed U-joint a painless process. The kit includes a new yoke, pinion nut, pinion spacer, pinion seal, u-joint and u-bolts. Alloy USA uses premium Spicer U-joints in all their yoke kits.

Yoke Conversion Kits - Converts Strap To U-Bolt Design, Includes Spicer U-Joint & U-Bolts

| Application | Part # |
|------------------------------|--------|
| Cherokee [XJ] 84-01, Dana 30 | 380001 |
| Cherokee [XJ] 84-95, Dana 35 | 380002 |



DIFFERENTIAL CABLE LOCK KITS

The Alloy USA® Differential Cable Lock Kit is a permanent replacement for the failure prone OE vacuum disconnect system. The kit allows you to engage and lock the front axle from inside the cab. A 1inch pull of the cable ensures you will have four wheel drive when you need it for as long as the transfer case is engaged. Backed by a three year warranty.



| Application | Part # |
|---|--------|
| Shift Fork, Cast Iron, For Use w/ Alloy USA or Posi Lok Differential Cable Lock Kit, Jeep W/ Front Dana 30 Cherokee [XJ] 84-91 NEW | 450100 |
| Differential Cable Lock Kit, With Front D30 Axle, Jeep Cherokee [XJ] 1984-1991 NEW | 450900 |
| Differential Cable Lock Kit, For 3-In To 6-In Lift, With Front D30 Axle, Jeep Cherokee [XJ] 1984-1991 NEW | 450920 |
| Differential Permanent Cable Lock Kit, Jeep w/ Front D30 Cherokee [XJ] 84-91 NEW | 451100 |

TRANSFER CASE CHAIN

If you're servicing your transfer case and your OE chain has more than 60,000 miles on it, it is time for a replacement. Why replace your chain when can upgrade it? Our advanced Round Pin technology allows the chain to double back on itself and offer greater articulation than the standard rocker pin design. We use high tensile strength steel to ensure that your TC chain endures peak loads under heavy operating conditions repeatedly over time. Backed by an industry leading three year warranty.



| Transfer Case Chain | Part # |
|--|--------|
| Transfer Case Chain, NP231 and NP233, 1" Width w/ 30 Links, Jeep Cherokee [XJ] 84-01, Grand Cherokee [ZJ] 93-97 NEW | 11650 |



TRANSFER CASE SLIP YOKE ELIMINATOR KIT

This kit is a MUST if you installed a 2" or taller suspension lift in your 1987-2001 Cherokee (not needed for body lifted Jeeps®). The kit fits all 1988 and up NP 231 transfer cases. A Slip Yoke Eliminator Kit (SYE) will eliminate the need to drop your transfer case in order to avoid drive train vibrations that are caused by taller suspension lift. The purpose of this kit is to replace the slip yoke portion of the NP 231 with a fixed yoke and CV-style drive shaft assembly. This reduces drive shaft angle, improves bearing & U-joint life, reduces driveline vibrations. It also has a shorter and stronger main shaft design with improved oiling. Will not work with cable driven speedometers. Not for use with Rubicon models.

WARNING: OEM slip yokes on 1987-2001 Jeep® Cherokee are not suitable for use with 2" or taller Rugged Ridge™ or other vendors' suspension lifts. Failure of slip yoke may result in damage to transfer case and/or loss of vehicle control. Use of this slip yoke eliminator kit is required for all suspension lifts 2" or taller. See additional product safety information and WARNINGS at back of catalog.



11400 Slip Yoke Eliminator Kit

| Transfer Case Slip Yoke Eliminator Kit | Part # |
|---|----------|
| 88-01 Cherokee Slip Yoke Eliminator (with NP231 transfer case) *, Kit | 11400 |
| Pinion Yoke | 18676.61 |
| Oil Seal | 18676.62 |
| Hardware Kit | 18676.64 |

*CV style drive shaft is required when using this conversion kit.

ALLOY USA® AXLE TUBE SEALS

Keep water, mud and debris from entering your front axle housing. These CNC machined aluminum housings feature two seals to provide double protection from the crud.



| Application | Part # |
|--|------------------------------|
| 1984-01 Cherokee [XJ], 1993-98 Grand Cherokee [ZJ] Dana 30 [1] | 11102 (RED) 11103 (BLACK) |
| 1984-01 Cherokee [XJ], 1993-98 Grand Cherokee [ZJ] Dana 30 or 44 front axle [2] NEW | 11105 (RED) 11106 (BLACK) |
| Replacement Inner Seal For 11102 and 11103 NEW | 11108 |
| Replacement Inner Seal For 11105 and 11106 NEW | 11109 |

[1] Note: Will not fit Grande 30 spine axles. For 27 Spline applications only.

[2] Note: For use with all grande 30 spline axle upgrades

DETROIT LOCKERS®

| Application | Part # |
|---|----------|
| Detroit Locker, Truetrac, Limited Slip Differential, Dana 30 27 Spline 3.07 to 3.54 Gear Ratio, Jeep Cherokee [XJ] 84-01, Grand Cherokee [ZJ] 93-98 | 912A584 |
| Detroit Locker, Truetrac, Limited Slip Differential, Dana 30 27 Spline 3.73 to 3.54 Gear Ratio, Jeep Cherokee [XJ] 84-01, Grand Cherokee [ZJ] 93-98 | 912A585 |
| Detroit Locker, Soft Locker, Locking Differential, Dana 30 3.73 to 5.38 Ratio, Jeep Cherokee [XJ] 84-01, Grand Cherokee [ZJ] 93-98, [WJ] 99-02, | 162SL60B |
| Detroit Locker, Truetrac, Limited Slip Differential, Dana 30 3.73 to 5.38 Ratio, Jeep Cherokee [XJ] 84-01, Grand Cherokee [ZJ] 93-98, [WJ] 99-02, | 912A314 |
| Detroit Locker, Limited Slip Differential, Dana 35 27 Spline 3.54 to 5.38 Gear Ratio, Jeep Cherokee [XJ] 90-01 | 162C56A |
| Detroit Locker, Truetrac, Limited Slip Differential, Dana 35 27 Spline 3.54 to 5.38 Gear Ratio, Jeep Cherokee [XJ] 84-01, Grand Cherokee [ZJ] 93-98, [WJ] 99-04 | 912A569 |
| Detroit Locker, Limited Slip Differential, Dana 35 30 Spline 3.54 to 5.38, Jeep Cherokee [XJ] 90-01 | 162C66A |
| Detroit Locker, Soft Locker, Locking Differential, Dana 44 3.92 to 5.38 Ratio, 30 Spline, Jeep Cherokee [XJ] 84-01, Grand Cherokee [ZJ] 93-98, [WJ] 99-02 | 187SL16C |

ARB® LOCKERS

ARB-RD105



| Application | Part # |
|---|-----------|
| ARB Air Locker, 1986-04 MJ, ZJ, WJ, SJ Dana 44 30 Spline 3.92 & UP Ratio | ARB-RD06 |
| ARB Air Locker, 1986-04 MJ, ZJ, WJ, SJ Dana 44 30 Spline 3.73 & DOWN Ratio | ARB-RD07 |
| ARB Air Locker, 1984-01 XJ, 1993-98 ZJ, Dana 30 27 Spline 3.73 & UP Ratio | ARB-RD100 |
| ARB Air Locker, 1984-01 XJ, 1993-98 ZJ, Dana 30 27 Spline 3.54 & DOWN Ratio | ARB-RD101 |
| ARB Air Locker, 1984-01 XJ, 1993-98 ZJ Dana 35 W/C-CLIP 27 Spline 2.73-3.31 Ratio | ARB-RD103 |
| ARB Air Locker, 1984-04 XJ, ZJ Dana 35 W/C-CLIP 27 Spline 3.54 & UP Ratio | ARB-RD102 |
| ARB Air Locker, 1991-01 Cherokee, Chrysler 8.25" 29 Spline, All Ratios | ARB-RD93 |
| ARB Air Locker, 99-04 WJ, 02-07 KJ, Super Dana 30, 3.73 and Up Ratio | ARB-RD104 |
| ARB Air Locker, Super Dana 35, C-CLIP, 30 SPL, 3.54 and Up Ratio | ARB-RD105 |

Cherokee 84-12

RING & PINION

Precision Gear® understands the rigors of racing. Horsepower is useless unless you can get it to the ground. Most companies providing ring and pinions today look for the cheapest source without consideration of quality. They “stand behind” their product until the day you buy it and install it on your car. At Precision Gear® each ring and pinion we sell is backed by an exclusive five year warranty! Our gears are made from high quality 8620 forgings and Gleason gear cutting technology because our gears are made to last!
 For additional product listings and more information visit www.precisiongear.com.



Master Installation Kits:

Precision Gear® understands the complexity of rebuilding your differential. To help solve this difficulty and eliminate multiple trips to the parts store we have including everything you need to complete your ring & pinion installation and get you back on the road quick all in one great kit. Master installation kits include:

Install Kit Includes:

- Carrier Bearings
 - Pinion Bearings
 - Pinion Nut
 - Pinion Seal
 - Preload Shims or Crush Collar
 - Pinion Shims
 - Gasket or RTV
 - Marking Compound
 - Differential Shims (where applicable)
 - Locktite
 - Oil Slingers (where applicable)
 - Ring Gear Bolts (where applicable)
- * Ring & Pinions and Installation Kits are sold separately.

| Dana 35 Ratio | | Part # | Dana 44 Ratio | | Part # |
|-------------------------|--|---------|-------------------------|--|-----------|
| 3.55 | | 350/355 | 3.23 | | 440/323 |
| 3.73 | | 350/373 | 3.31 | | 440/331 |
| 4.10 | | 350/410 | 3.42 | | 440/342 |
| 4.56 | | 350/456 | 3.54 | | 440/354 |
| 4.88 | | 350/488 | 3.73 | | 440/373 |
| Master Installation Kit | | 352049 | 4.09 | | 440/409 |
| | | | 4.27 | | 440/427 |
| | | | 4.56 | | 440/456 |
| | | | 4.56 | | 440/456TH |
| | | | 4.88 | | 440/488 |
| | | | 4.88 | | 440/488TH |
| | | | 5.13 | | 440/513 |
| | | | Master Installation Kit | | 352033 |

Cherokee 84-12

COMMANDER BULL BARS

| Commander Bull Bar | Part # |
|--|----------|
| 3" Bull Bar 06-09 Commander, Black | 82001.17 |
| 3" Bull Bar 06-09 Commander, Stainless | 82501.17 |

GRAND CHEROKEE & LIBERTY CATBACK EXHAUST KITS

| Grand Cherokee & Liberty Exhaust Kits | Part # |
|---|----------|
| 99-04 4.7, 4.0L Grand Cherokee, Catback Exhaust Kit | 17606.53 |
| 02-06 2.4, 3.7L Liberty, Catback Exhaust Kit | 17606.54 |



RUGGED RIDGE® SOFT TOPS-QUALITY, INNOVATION AND VALUE ALL IN ONE TOP!

At Rugged Ridge® we take the design and development of Soft Tops seriously. Each Top is designed, tested and used by Jeep® owners to ensure you get the finest product available. By using only the finest materials available, we are able to offer an exclusive 3 year limited warranty on all our tops! No other soft top manufacturer offers a warranty that covers this length of time.

When looking for a new top for your Jeep® or SUV, there are several important features and options to consider. The following will help guide you in your soft top choice:

QUALITY

All Rugged Ridge® Soft tops use an industry leading 30 mil DOT approved glass. This extra thick glass ensures a long lasting top as the plastic glass used on soft tops is usually the first thing to wear out. All Rugged Ridge® tops use the toughest soft top fabrics ensuring a long life. Whether it is our durable vinyl coated polyester denim or diamond fabric, or a sail cloth type material, we want the top to perform as well as it looks. Pulling it all together, Rugged Ridge® uses marine grade thread that is designed to be used in the harshest environments. This thread will not fade or rot in the sun and combined with durable heat sealed seam tape, keeps the elements out!



Only the finest fabrics



30 Mil DOT approved glass



Seam Sealed Marine grade thread

INNOVATION

Rugged Ridge® offers a soft top solution for your vehicle that has the Jeep® lifestyle in mind. Tops like our Bowless soft tops that use the roll bar for the bow system or the amazing Power Top which is the first TRUE convertible top for Jeep® both are designed to be user friendly and offer features found nowhere else. We take the "Jeep® Experience" seriously and have a soft top solution to meet your needs!



The innovative NEW Bowless top - easy to use, a great value!



Pocket Briefs and Island Toppers Provide needed storage!

VALUE

Rugged Ridge® has a soft top design to fit your budget! Why spend more than you have to on a top when Rugged Ridge® can provide you with the same quality and a longer warranty for less! Our tops may not be the least expensive on the market but you get more top for your money with Rugged Ridge®. Because we offer several soft top solutions (Summer Brief, Island Topper, fabric only, Bowless, Power) we can supply you a top that fits your budget with the quality you demand.

Introducing

07-12 WRANGLER
POWER TOP

See page U3 for more
information

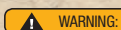

WARNING:

Loss of vehicle control involves risk of death or serious injury, particularly to parts of your body not restrained within vehicle. This product is intended for weather protection only and should not be relied upon to contain occupants in the event of an accident or to protect from either ground contact or falling objects. To reduce risk of accident injury:

• Always wear seat belts.

• Read and follow all instructions and warnings accompanying this product, in vehicle owners manual and Off Road Driving Supplement.

All images are subject to be representative. More detailed information is available online.

NEW POWER TOP

BY RUGGED RIDGE®

The first true convertible top for 07-12 Wranglers



Accessories

POWER TOP AUTOMATICALLY GOES UP AND DOWN WITH THE PUSH OF A BUTTON!



Rugged Ridge® is excited to announce the first ever true convertible top for the 4 door JK Jeep® Wrangler. No more struggling to get your soft top up and down. This revolutionary soft top design automatically goes up and down without you even getting out of the vehicle. Our patent pending design allows the top to be lowered or raised in seconds by unlatching two header latches and the simple push of a button! In development for over a year, the engineers at Rugged Ridge® have created a heavy duty frame system that folds up and over your factory roll bar therefore making the "push button" design possible. The Power Top Kit fits all 2007-2012 four door Wranglers and comes complete with heavy duty sailcloth fabric, 31% tint 30 mil rear window glass, power top frame, hydraulics, wiring harness and an in-depth installation packet. Everything you need to make your JK a true convertible top!

NEW!



Each Power top is a complete kit that includes everything you need for installation to your 2007-2012 four door Wrangler: heavy duty sailcloth fabric, 31% tint 30 mil rear window glass, power top frame, hydraulics, motor, wiring harness and an in-depth installation packet. Bolt-on installation, No fabrication necessary.



WARNING:

Loss of vehicle control involves risk of death or serious injury, particularly to parts of your body not restrained within vehicle. This product is intended for weather protection only and should not be relied upon to contain occupants in the event of an accident or to protect from either ground contact or falling objects. To reduce risk of accident injury. Always wear seat belts. Read and follow all instructions and warnings accompanying this product, in vehicle owners manual and Off Road Driving Supplement.



LOOK AT THESE EXCLUSIVE FEATURES:

- The kit has everything needed for a complete installation including the soft top, frame, door surrounds, motor, hydraulics and wiring. Installation requires that you reuse the factory header and rear tailgate bar. One kit fits all years of 4 door Wrangler!
- Professional installation is recommended but a skilled do it yourselfer can also install it and no special tools are required. **Estimated install time for a skilled installer is approximately 5 hours.**
- The [patent pending] 4 door version will be available first but we also have a 2 door version in development.
- The frame comes pre-assembled and ready for installation and is constructed from corrosion resistant powder coated steel. All fasteners and bushing are specified for high grade strength and wear resistance.
- The frame installs to the tub rail using pre-existing holes along the top and then one hole is required over either wheel well on both sides to provide added support for strength, rigidity and smooth operation.
- Injection molded door surrounds are included to replace the factory surrounds to ensure a weather tight seal.
- The frame is powered by an electric motor with a hydraulic pump that drives two hydraulic cylinders. The motor and wiring relays mounts underneath the rear deck lid where it is concealed neatly out of the way.
- The motor and hydraulic cylinders come pre-assembled and ready to install with adjustable flow control valve, hoses, fittings and fluid [pre-bled].
- The top is constructed from premium sail cloth fabric and includes a zip-out removable DOT approved 30 mil rear window with 31% smoke tint.
- The system includes all wiring, relays, and switches for a complete installation. The wiring scheme is a simple yet very effective design and protects against improper operation or damage of the top by only working when the drivers' foot is on the brake.
- Limit switches are also included to control the power when the top is either fully up or fully down for added safety and to reduce wear and stress on the system.
- Operation of the top is extremely easy and effortless. From the driver's seat you simply unlatch the header and [while your foot is on the brake and key in ignition] push the switch. Down it goes! That's it!
- The power top is designed to stay on the vehicle full time once it is installed. However, it can also be removed from time to time if necessary thus permitting the owner to change it over to their hard top in winter or to return the vehicle to a factory style top.
- Service and replacement parts will be readily available.
- The entire system and all components are covered by our 3 year warranty.



A durable hydraulic piston provides the torque to lift and retract the Power Top. Easily secured to the vehicle wheel well and soft top frame, this durable component has been cycle tested to ensure a long life and consistent performance.



The Name Power Top comes from a durable electric power plant that has been specially developed for strength and size. This heavy duty motor installs in the storage compartment in the rear of your Jeep® keeping the rear cargo area clutter free. Each Power top includes the necessary wiring harness to make installation as easy as possible.



All Power tops have a tinted rear window that either rolls up or can be completely zipped out. This allows for that open air experience that Jeep® owners love! All Window glass is extra thick 30mil DOT approved with 31% tint. Quality and superior function all in one!

Power Top

Power Top Kit, Black Sail Cloth, Jeep® Wrangler [JK] 4-Door 2007-2012 **NEW**

* 2 Door JK is planned for 2012 introduction

Part#

13515.01

All images are subject to be representative. More detailed information is available online.

XHD REPLACEMENT SOFT TOPS FOR JEEP®, SUZUKI®, AND GEO®



New and improved XHD Replacement Soft-Tops from Rugged Ridge® are now available with 50% thicker glass! Each Fabric Soft Top is specifically designed to easily fit the factory original soft top hardware. Simply take off the old top and slip on the new. It's just that easy! These new designs feature reinforced stitching on the heavy "pull" areas as well as heavy duty 30 mil thick glass! All XHD Soft Tops feature durable vinyl coated polyester and cotton fabric that will last the test of time. All sewn seams use marine grade thread to make sure it does not deteriorate or discolor in the sun. Each seam is literally "welded shut" with durable heat seal tape to keep moisture out while keeping the original look of the top intact. Attaching the Rugged Ridge® Top is easy with the factory original "belt rail" attachment method; simply tuck under the rail and go! Most of our tops feature two choices of door options; with upper soft doors or with full hard doors. Each Jeep® application has removable windows for that Safari look and true open air driving! Also available is your choice of DOT approved 31% tinted side and rear windows or crystal clear DOT approved side windows (Door windows are not tinted). Each top is backed by an industry leading 3 year limited warranty against manufacturer defects. When only the best will do, look to Rugged Ridge®!

Accessories

The most comprehensive line of replacement soft tops on the market, so you can choose what options are best for you!



53703.15 Fabric Replacement Soft Top

53701.52 Fabric Replacement Soft Top



Rugged Ridge® offers a full line of replacement soft tops for the 1988-98 Suzuki and Geo Tracker vehicles! Our value priced soft tops will freshen up the look of your vehicle while not "breaking the bank". Each top is constructed of durable vinyl coated polyester soft top fabric with DOT approved, UV treated, crystal clear 30 mil windows for long life and durability. Windows for Suzuki Samurai do not zip out. The rear window only for 1988-94 Sidekick/Geo Tracker zips out. Both rear and side windows for 1995-98 Sidekick/Geo Tracker zip out.

All Rugged Ridge® fabric replacement tops are designed to fit over original factory hardware only and do not include hardware in the kit. If your factory top has half hard doors, the kits that include soft upper door skins have custom door skins that attach directly to your factory door frames using durable hook and loop fasteners. Simply cut off the old fabric and install the new. Missing or have damaged soft top/door hardware? See pages U6 & U10 for replacement hardware/door components to give your soft top a complete "makeover".

THE ONLY REPLACEMENT SOFT TOP WITH A 3 YEAR LIMITED WARRANTY!



WARNING:

Loss of vehicle control involves risk of death or serious injury, particularly to parts of your body not restrained within vehicle. This product is intended for weather protection only and should not be relied upon to contain occupants in the event of an accident or to protect from either ground contact or falling objects. To reduce risk of accident injury. Always wear seat belts. Read and follow all instructions and warnings accompanying this product, in vehicle owners manual and Off Road Driving Supplement.



NEW 30 mil thick DOT approved windows are 50% thicker than lower cost soft tops! Available in clear or 31% tint (rear quarter and rear glass) on most Jeep® models.



Jeep® applications (and late model Suzuki) feature zip out windows for the true open air experience. Each side and rear window have durable zipper attachments covered by weather seals to keep the weather out



Rugged Ridge® soft tops use only the finest vinyl coated polyester fabric or durable sail cloth on all their tops. Each fabric color is specially formulated to match the original equipment colored top to make your Jeep® look like it came off the show room floor.

XHD SOFT TOP APPLICATIONS

| Fabric Replacement Tops for 88-95 Wrangler | Charcoal | Black Denim | Diamond Black | Spice |
|--|---------------|---------------|---------------|----------|
| W/Door Skins | 13721.09 | 13721.15 | - | 13721.37 |
| W/Door Skins, Tinted Windows | 13722.09 | 13722.15 | 13722.35 | 13722.37 |
| Fabric Replacement Tops for 97-02 Wrangler | Black Denim | Dark Tan | Diamond Black | Spice |
| W/Door Skins | 13723.15 | 13723.33 | - | 13723.37 |
| W/Door Skins, Tinted Windows NEW | 13724.15 | 13724.33 | *13724.35 | 13724.37 |
| No Door Skins | 13725.15 | 13725.33 | - | 13725.37 |
| No Door Skins, Tinted Windows | 13726.15 | 13726.33 | - | 13726.37 |
| Fabric Replacement Tops for 03-06 Wrangler | Diamond Black | Diamond Khaki | - | - |
| W/Door Skins | 13727.35 | 13727.36 | - | - |
| W/Door Skins, Tinted Rear Windows | 13728.35 | 13728.36 | - | - |
| No Door Skins | 13729.35 | 13729.36 | - | - |
| No Door Skins, Tinted Rear Windows | 13730.35 | 13729.36 | - | - |
| Without Door Skins, Jeep® Wrangler Unlimited (LJ) 04-06 NEW | *13731.35 | - | - | - |
| Fabric Replacement Tops for JK | Diamond Black | Diamond Khaki | - | - |
| Without Door Skins, Jeep® Wrangler (JK) 07-09 2-Door NEW | *13736.35 | 13736.36 | - | - |
| Without Door Skins, Jeep® Wrangler (JK) 07-09 4-Door NEW | *13741.35 | 13741.36 | - | - |
| Sailcloth Fabric Replacement Tops for TJ and JK | Sailcloth | - | - | - |
| XHD Replacement Soft Top W/Door Skins, Tinted Windows, Sail Cloth, 30 Mil Glass, Jeep® Wrangler (TJ) 97-06 NEW | *13728.01 | - | - | - |
| Black Diamond Sailcloth, With Tinted Windows, Without Door Skins, Jeep® Wrangler (JK) 07-09 2-Door NEW | *13736.01 | - | - | - |
| XHD Replacement Soft Top, Black Diamond Sail Cloth, With Tinted Windows, Without Door Skins, Jeep® Wrangler (JK) 07-09 4-Door NEW | *13741.01 | - | - | - |
| Fabric Replacement Tops for Suzuki® / Geo Tracker | Black Denim | White Denim | - | - |
| Suzuki® Samurai, 85-95 (Rear & side windows roll up) | 53721.15 | 53721.52 | - | - |
| 88-94 Suzuki® Sidekick/Geo Tracker (only rear windows zips out) | 53722.15 | 53722.52 | - | - |
| 95-98 Suzuki® Sidekick/Geo Tracker (rear & side windows zip out) | 53723.15 | 53723.52 | - | - |



| Door Skins | Gray | Black Denim | Diamond Black | Spice | Dark Tan | Diamond Khaki |
|---------------------------|----------|-------------|---------------|----------|----------|---------------|
| 88-95Wrangler NEW | 13716.09 | 13716.15 | 13716.35 | 13716.37 | - | - |
| 97-06Wrangler NEW | - | 13717.15 | 13717.35 | 13717.37 | 13717.33 | 13717.36 |
| Upper Doors | Gray | Black Denim | Diamond Black | Spice | Dark Tan | Diamond Khaki |
| 88-95 Wrangler NEW | 13713.09 | 13713.15 | 13713.35 | 13713.37 | - | - |
| 97-06 Wrangler NEW | - | 13714.15 | 13714.35 | 13714.37 | 13714.33 | 13714.36 |

REPLACEMENT DOOR SKINS

NEW Door Skins now available to replace your factory soft upper door fabric & glass. These door skins come in pairs and fit over your factory door frames with durable hook and loop fasteners. Simply cut off the old and slip on the new! Each door skin feature double zippers and heavy duty bulb seals for ease of use and a weather tight fit. Crystal clear 30 mil DOT approved door window glass will last the test of time.

UPPER DOORS

Soft upper door models have door skins that feature double zippers and heavy duty bulb seals for ease of use and a weather tight fit. Crystal clear 30 mil DOT approved door window glass will last the test of time.

All images are subject to be representative. More detailed information is available online.

BOWLESS TOP FOR 97-06 WRANGLER

The Bowless Top from Rugged Ridge® is the most versatile Jeep® soft top on the market. It allows you to convert instantly from a full top to a summer brief, and eliminates the need for the bulky OE soft top frame. The Bowless Top fits snugly over the factory roll bar for a more aerodynamic “fastback” look, but retains your factory door surrounds and tailgate bar to provide an air tight fit. Convert to a summer brief by simply unzipping the side windows and stowing them in the rear window storage fold designed into the top. The Bowless top is made to the same specifications as our factory replacement tops and features: reinforced stitching on the heavy “pull” areas, as well as heavy duty 30 mil thick DOT approved 31% tint window glass, durable vinyl coated polyester and cotton fabric or durable sail cloth, and all sewn seams use marine grade thread to make sure it does not deteriorate or discolor in the sun.



Windows fold up under top for open air driving.

Top includes 2 zippered storage pockets.

More Exclusive Features:

- NEW design is less complex and easier to install than competitive brand tops.
- Custom design fits better using significantly fewer straps and no center bow. Our bowless top uses only two Velcro side straps, one center adjusting strap and two rear straps making a better fitting, easier to install top
- All straps are inside the top making for a cleaner better looking design
- Rear window either rolls up or can be used as the storage flap for side windows. No extra pockets or complicated securing device to store your rear quarter windows
- Side weather protecting foam is attached to the top. Competitive brands have this foam separate from the top creating a potential missing part
- Each Top includes a pair of handy zippered side pockets for map and accessory storage
- Side design includes a handy installation pull tab for ease of installation
- Notorious leak spots behind the doors have been covered with a special rain flap; keeps the weather out!
- Backed by our industry leading three year limited warranty. Most soft top warranties are only 1-2 years!



BLACK DIAMOND



SPICE



BLACK SAIL CLOTH

Bowless Tops

| | Part# |
|---|----------|
| Bowless Soft Top, Black Diamond, 97-06 Wrangler, for use with OE door surrounds. NEW | 13750.35 |
| Bowless Soft Top, Denim Spice, 97-06 Wrangler, for use with OE door surrounds. NEW | 13750.37 |
| Bowless Soft Top, Black Sail Cloth, 97-06 Wrangler, for use with OE door surrounds. NEW | 13750.01 |
| Bowless Soft Top, Black Diamond, 97-06 Wrangler, includes replacement door surrounds. NEW | 13751.35 |
| Bowless Soft Top, Denim Spice, 97-06 Wrangler, includes replacement door surrounds. NEW | 13751.37 |
| Bowless Soft Top, Black Sail Cloth, 97-06 Wrangler, includes replacement door surrounds. NEW | 13751.01 |

* Hard top models will need factory door surrounds to install this top.
 Note: Requires a separate windshield header (Omix PN: 13308.04) and your factory tailgate bar for installation.
 (Replacement tailgate bar available - Omix PN: 13550.01)

POCKET BRIEFS

Tired of papers and other small items flying around the cab of your Jeep® when using your Summer Brief? Introducing the most innovative new addition to a Summer Brief in over 50 years the Pocket Brief from Rugged Ridge®! This revolutionary design incorporates two mesh zippered corner pockets directly over the driver and passenger creating much needed storage space. Special two sided mesh and nylon "pocket" seals shut with a reinforced zipper, keeping small items secure even in most severe conditions. Each pocket is built directly into the Rugged Ridge® Summer Brief to ensure a clean, tight fit. Constructed of durable soft top fabric for long life. Available in matching soft top colors to give your Jeep® a finished look.



All Briefs feature quick release buckles for easy on/off installation



| Pocket Briefs | Gray | Denim Black | Spice | Diamond Black | Diamond Khaki |
|-------------------------------------|----------|-------------|----------|---------------|---------------|
| 10-12 Wrangler, 2-Door * NEW | - | - | - | 13590.35 | 13590.36 |
| 07-09 Wrangler, 2-Door * | - | - | - | 13587.35 | 13587.36 |
| 97-06 Wrangler, Unlimited ** | - | 13585.15 | 13585.37 | 13585.35 | 13585.36 |
| 92-95 Wrangler *** | 13584.09 | 13584.15 | 13584.37 | - | - |
| 87-91 Wrangler *** | - | 918315 | - | - | - |

* Requires a separate Windshield Header [#13308.06] for installation ** Requires a separate Windshield Header [#13308.04] for installation *** Requires a separate Windshield Channel [#13308.01] for installation

SUMMER BRIEFS

Custom designed for each body style, these easy on, easy off briefs provide protection from the hot sun and sudden showers. Each Rugged Ridge® Summer Brief attaches to the factory center hoop and windshield with heavy-duty nylon straps to prevent flapping. Key rear strap attachments have quick release fasteners so once your straps are set, they easily detach and reattach. Wrangler models also incorporate thick hook and loop side mounts to further secure the top. All 97-06 models are designed to be used with a no-drill Windshield Header [sold separately, see page U8] for quick conversion from hard top to Summer Brief.



| Summer Briefs | Black | Gray | Denim Black | Spice | Diamond Black | Diamond Khaki |
|---|----------|----------|-------------|----------|---------------|---------------|
| Header Summer Brief, 97-06 Wrangler ² , Unlimited ² | - | - | 13580.15 | 13580.37 | 13580.35 | 13580.36 |
| Summer Brief, 92-95 Wrangler ³ | - | 13574.09 | 13574.15 | 13574.37 | - | - |
| Summer Brief, 87-91 Wrangler ³ | 13573.01 | 13573.09 | 13573.15 | - | - | - |
| Summer Brief, 76-86 CJ7 ³ | 13572.01 | - | - | - | - | - |
| Summer Brief, 76-83 CJ5 ³ | 13571.01 | - | - | - | - | - |
| Summer Brief, 55-75 M38A1 & CJ5 | 13570.01 | - | - | - | - | - |

² Requires separate Windshield Header [#13308.04] for installation. ³ Requires separate Windshield Channel [#13308.01] for installation. ⁴ Includes Pockets.

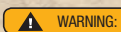

WARNING:

Loss of vehicle control involves risk of death or serious injury, particularly to parts of your body not restrained within vehicle. This product is intended for weather protection only and should not be relied upon to contain occupants in the event of an accident or to protect from either ground contact or falling objects. To reduce risk of accident injury, Always wear seat belts. Read and follow all instructions and warnings accompanying this product, in vehicle owners manual and Off Road Driving Supplement.

All images are subject to be representative. More detailed information is available online.

POCKET ISLAND TOPPERS



The most advanced summer soft top solution found on the market today, the new Pocket Island Topper! This new design features tough diamond fabric combined with a pair of zipper front pockets for the ultimate full featured top. Unlike other summer tops on the market, the Rugged Ridge® design features wider side hook and loop fastener straps, a reinforced front section and extra heavy duty nylon tie down straps.



| Pocket Island Toppers | Diamond Black | Diamond Khaki |
|-------------------------------------|---------------|---------------|
| 10-12 Wrangler, 2-Door * NEW | 13591.35 | 13591.36 |
| 10-12 Wrangler, 4-Door * NEW | 13592.35 | 13592.36 |
| 07-09 Wrangler, 2-Door * | 13588.35 | 13588.36 |
| 07-09 Wrangler, 4-Door * | 13589.35 | 13589.36 |
| 97-06 Wrangler ** | 13586.35 | 13586.36 |

* Requires a separate Windshield Header [#13308.06] for installation ** Requires a separate Windshield Header [#13308.04] for installation

ISLAND TOPPERS



Provide the ultimate summer sun and rain protection with a Rugged Ridge® Island Topper. Attaching the same way as our durable Summer Briefs, these full length tops provide protection from the elements for both the front and rear passengers. Rear attachment straps attach to the rear sport bar hoops on 1992-06 models. 1976-91 models include an easy to attach rear bow. All 1997-06 models are designed to be used with an optional, no-drill Windshield Header for quick conversion from hard top to Island Topper.

| Island Toppers | Gray | Denim Black | Spice | Diamond Black | Diamond Khaki |
|---------------------------------------|----------|-------------|----------|---------------|---------------|
| Header Island Topper, 97-06 Wrangler* | - | 13581.15 | 13581.37 | 13581.35 | 13581.36 |
| Island Topper, 92-95 Wrangler** | 13553.09 | 13553.15 | 13553.37 | - | - |
| Island Topper, 76-91 CJ & Wrangler ** | 13554.09 | 13554.15 | - | - | - |

* Requires a separate Windshield Header [#13308.04] for installation ** Requires a separate Windshield Channel [#13308.01] for installation

WINDSHIELD CHANNELS/HEADERS

These upgraded preassembled no drill windshield headers install quickly and easily! Just attach your Brief/Island Topper and place the header channel on the top of your windshield, slide the clamps onto the supplied knobs and clamp the channel in place. That's it! The channel is now securely held in place and ready for summer wheeling. No drilling or modifications required on 1997-12 windshield header models! Note: Will work with Bestop® and other aftermarket summer tops. No Drill Windshield Header required for installation of Summer Briefs and Island Toppers on all 1997-12 Wranglers. Windshield Channels are required for installation of Summer Briefs and Island Toppers on all 1976-95 CJ/Wranglers.



13308.05 Upgrade Windshield Header for 07-12 Wrangler

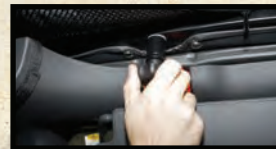

NOTE: If your 76-95 Jeep* already has a Windshield Channel installed on it, we highly recommend replacing it. Over time, these channels can come loose and will no longer hold your Summer Brief/Island Topper in place.

| Channels/Headers | Part# |
|--|----------|
| Header, 07-12 Wrangler, 2 & 4-Door, Each NEW | 13308.06 |
| Deluxe Windshield Header, 07-12 Wrangler, 2 & 4-Door, Each | 13308.05 |
| Windshield Header, 97-06 Wrangler (no drill), Each | 13308.04 |
| Windshield Channel, 76-95 Jeep® CJ & Wrangler, Each | 13308.01 |
| Windshield Channel, 97-02 Wrangler (drilling required), Each | 13308.02 |

Custom designed to fit today's most popular sized tires. Constructed of durable vinyl coated polyester fabric. Colors match other Rugged Ridge® Soft Accessories. Please measure tire diameter.

TIRE COVERS



| Tire Diameter | Black | Gray | Denim Black | Spice | Diamond Black | Diamond Khaki |
|---------------|----------|----------|-------------|----------|---------------|---------------|
| 27"-29" | 12801.01 | 12801.09 | 12801.15 | 12801.37 | 12801.35 | 12801.36 |
| 30"-32" | 12802.01 | 12802.09 | 12802.15 | 12802.37 | 12802.35 | 12802.36 |
| 33" | - | 12803.09 | 12803.15 | - | 12803.35 | - |
| 35"-36" | - | 12804.09 | 12804.15 | - | 12804.35 | - |

Note: To ensure proper fit, measure the diameter of the tire you are covering and pick the appropriate tire cover size listed above.



All images are subject to be representative. More detailed information is available online.

MESH POCKET BRIEFS & ISLAND TOPPERS

Special UV treated mesh fabric blocks the heat while allowing the cool breeze to flow through. The special weave of the Rugged Ridge® mesh brief/Island Topper is designed for strength and durability while providing open air protection from the sun's heat. Available in two great styles: the Summer Brief that goes to the center hoop and the "Island Topper" that goes back to cover those rear seat passengers. Don't forget the Header/Windshield channel needed to install these tops!

Sun Stop Mesh Summer Brief



Sun Stop Mesh Island Topper



Mesh Pocket Briefs / Island Toppers

| | Part # |
|--|----------|
| Mesh Summer Brief, 07-09 Wrangler 2-Dr, Each * | 13579.02 |
| Mesh Summer Island Topper, 07-09 Wrangler 2-Dr, Each * | 13579.01 |
| Mesh Summer Island Topper, 07-09 Wrangler 4-Dr, Each * | 13579.03 |
| Mesh Island Top, 10-11 Wrangler 2-Dr NEW | 13579.11 |
| Mesh Island Brief, 10-11 Wrangler 2-Dr NEW | 13579.12 |
| Mesh Island Top, 10-11 Wrangler 4-Dr NEW | 13579.13 |
| Mesh Summer Brief, 97-06 Wrangler, Unlimited, Each ** | 13576.01 |
| Mesh Island Topper, 97-06 Wrangler, Each ** | 13578.01 |
| Mesh Summer Brief, 92-95 Wrangler, Each *** | 13575.01 |
| Mesh Island Topper, 92-95 Wrangler, Each *** | 13577.01 |

* Requires a separate Windshield Header [#13308.05] for installation
 ** Requires a separate Windshield Header [#13308.04] for installation
 *** Requires a separate Windshield Channel [#13308.01] for installation



Mesh Summer Briefs/Island Toppers include a pair of zippered corner storage pockets

ACOUSTIC BRIEF & ISLAND TOPPER

This unique design drastically reduces road noise within the cab of your Jeep®. We have lined each Acoustic piece with a tightly woven, padded acoustic insert that absorbs outdoor noise to allow for a pleasant driving experience. You can finally listen to your favorite radio or CD while you enjoy open air driving! Durable quick release buckles for easy on - easy off installation. Acoustic Brief provides overhead protection for both front seat passengers. Acoustic Island Topper provides overhead protection for both front & rear passengers.



Padded insert absorbs noise allowing for a more pleasant driving experience

WARNING:

Loss of vehicle control involves risk of death or serious injury, particularly to parts of your body not restrained within vehicle. This product is intended for weather protection only and should not be relied upon to contain occupants in the event of an accident or to protect from either ground contact or falling objects. To reduce risk of accident injury:

- Always wear seat belts.
- Read and follow all instructions and warnings accompanying this product, in vehicle owners manual and Off Road Driving Supplement.

Acoustic Island Topper, Black Denim

| | Part # |
|------------------------|----------|
| 97-06 Wrangler, Each * | 13582.15 |

Acoustic Brief, Black Denim

| | Part # |
|----------------------------------|----------|
| 97-06 Wrangler/Unlimited, Each * | 13583.15 |

* Requires a separate windshield header [#13308.04] for installation.



ROLL BAR CURTAIN

Provides protection from dust, rain and other debris from entering the cab of your Jeep® and also keeps heat in during the cold winter months. Easily attaches to the sport bar with durable nylon straps. Constructed of durable soft top fabric that matches other Rugged Ridge® Accessories. Special rear opening allows for easy access to cargo area: zips open and closed. DOT approved rear glass allows for rear visibility.

| Roll Bar Curtain | Gray | Price | Denim Black | Price | Spice | Price | Diamond Black | Price | Diamond Khaki |
|--------------------------------|----------|-------|-------------|-------|----------|-------|---------------|-------|---------------|
| 80-06 CJ, Wrangler & Unlimited | 13552.09 | | 13552.15 | | 13552.37 | | 13552.35 | | 13552.36 |

ROLL BAR COVER KITS

Custom covers dress up your vehicle's roll bar with light weight foam and summer soft goods fabric. Roll Bar Covers easily install using zippers and "hook & loop" attachments. Special cut outs for seat belt locations make the covers look clean. Multiple piece design available for 1992-02 Wrangler models with over the door cross members.

Roll Bar Cover Kits

| | Part # |
|---|----------|
| 97-02 Wrangler, Denim Black, 3 pc. Kit | 13612.15 |
| 92-95 Wrangler, Denim Black, 3 pc. Kit | 13611.15 |
| 78-91 CJ & Wrangler, Denim Black, 1 pc. Main Hoop Cover * | 13610.15 |
| 78-91 CJ & Wrangler, Black, 1 pc. Main Hoop Cover * | 13610.01 |

*87-91 Wrangler- Does not include the two over door side bar covers





SOFT TOP STORAGE BOOT

Protect your soft top when it is folded down. Keeps soft top close by in case of sudden showers. Designed to be used with the windows zipped out.

| Soft Top Storage Boot | Part # |
|--|----------|
| 07-12 Wrangler 2-Door, Black Diamond, Each | 12104.50 |
| 07-10 Wrangler 4-Door, Black Diamond, Each | 12104.51 |
| 97-06 Wrangler, Black Denim, Each* | 12104.15 |
| 97-06 Wrangler, Spice, Each* | 12104.37 |
| 76-95 CJ/Wrangler, Black Denim, Each | 12105.15 |
| 76-95 CJ/Wrangler, Spice, Each | 12105.37 |

* Will not fit Wrangler Unlimited

SOFT TOP & WINDOW STORAGE SOLUTIONS

12106.01
Soft Top Storage Bag



Prolong the life of your soft top or windows with this handy storage bag from Rugged Ridge®. Features special soft sided fabrics protect your soft top or windows. Both solutions use oversized zippers and durable nylon fabrics for long life and weather resistance. Special handle placement allows for easy carrying and storage.



12107.01
Window Storage Bag

| Soft Top & Window Storage Solutions | Part # |
|--|----------|
| Soft Top Storage Bag, Each | 12106.01 |
| Window Storage Bag, Each (Holds 2 Windows) | 12107.01 |
| Window Storage Bag, roll-up, Each, 07-12 Wrangler NEW | 12107.05 |

12107.05
Roll Up Storage Bag

Accessories



12108.01 Hard Door Storage Bag



Storage Bags Have A Soft Interior To Cradle your Doors

Oversized Zippers & Durable Nylon Provide Years of Service

HARD DOOR STORAGE BAGS

Prolong the life of your hard doors with this handy storage option from Rugged Ridge®. Each storage bag features special soft sided fabric that "cradles" your hard door. We use oversized zippers and durable nylon fabrics for long life and weather resistance. Special handle placement allows for easy carrying and storage.

| Storage Bags | Part # |
|------------------------------|----------|
| 76-06 CJ/Wrangler Hard Doors | 12108.01 |

REPLACEMENT SOFT TOP UPPER DOOR FRAMES



13701.80 Door Frame, 87-95 Wrangler



13703.80 Door Frame, 97-06 Wrangler

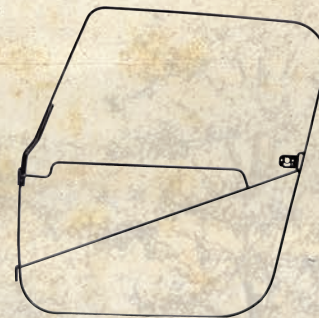

13715.80 Door Frame, 76-86 CJ7

Until now, these door frames have been very hard to find. Leave it to Rugged Ridge® to solve yet another problem! Upper door steel frames for factory soft top Jeep® models. Update your top by replacing those worn out doors! Simply slip on your replacement door skins (sold separately or as a part of our XHD Soft Top Kits) and you have up-graded that old top. Each frame is designed to fit factory soft top applications only. Sold as a pair. Rugged Ridge® door skins not available for CJ7.

| Soft Top Door Frames | Part # |
|------------------------|----------|
| 97-06 Wrangler, Pair * | 13703.80 |
| 87-95 Wrangler, Pair * | 13701.80 |
| 76-86 CJ7, Pair ** | 13715.80 |

* Will only fit original style factory soft upper door skins

** Will only fit original style factory door skins

REPLACEMENT TOP HARDWARE FOR 87-95 YJ

Includes all the necessary components to completely replace/upgrade your factory original soft top hardware. Our exclusive OE quality tailgate bar provides an upgraded tailgate seal and easy installation. Adjustable Side Spreader Bars have been upgraded to ensure a long life. Combine with a fabric only XHD replacement top for an inexpensive complete soft top.

**Replacement Hardware****Part #**

87-95 YJ Wrangler, Kit

13510.01

REPLACEMENT SPREADER BARS 87-95 YJ

Upgrade or replace those worn original equipment YJ Spreader Bars. Deluxe Spreader Bars are upgrades from original and are sold individually. Ultimate Spreader Bars, sold in pairs, incorporate a twist soft top tightening feature that can tighten your soft top during warm weather.

**Replacement Spreader Bars****Part #**

Deluxe Spreader Bar, 87-95 YJ Wrangler, Each

11251.01

Ultimate Adjustable Spreader Bars, 87-95 YJ Wrangler, Pair

11251.02

SOFT TOP WINDSHIELD RETAINER FOR 87-95 YJ

Replaces factory plastic retainers that are mounted vertically on the left and right side of the YJ windshield frame inside the vehicle. Available in pairs or individually. Each mounts to factory screw locations for ease of installation

**Windshield Retainers****Part #**

87-95 Wrangler, Drivers Side, Each

12306.03

87-95 Wrangler, Pass. Side, Each

12306.04

87-95 Wrangler, Pair

12306.05

SOFT TOP DISCONNECTS

11251.04 Soft Top Disconnect for 07-12 Wrangler 4-Door

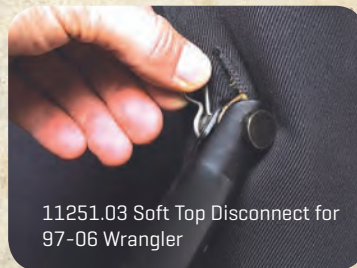

11251.03 Soft Top Disconnect for 97-06 Wrangler

Upgrade your factory 1997-06 or 2007-12 Wrangler Soft Top Hardware with these quick release bow mounts. Allows for easy, no tool disconnect of your soft top bows from your Jeep®. Installation is easy and quick, no drilling required.

Soft Top Disconnect Kit**Part #**

07-12 Wrangler 4-Door, 4 pack

11251.04

97-06 Wrangler, 4 pack

11251.03

Tailgate Bar/Tonneau

**REPLACEMENT TAILGATE BAR WITH TONNEAU COVER**

Upgrade your rear tailgate bar with this high quality Tonneau/Tailgate Bar from Rugged Ridge®. A special double tailgate seal provides the ultimate attachment for your rear soft top window to the tailgate bar. As an added feature, a special channel has been added to attach the enclosed behind the seat tonneau cover to keep valuables out of sight.

Double seal provides weather protection!

**Replacement Tailgate Bar w/ Black Denim Tonneau****Part #**

87-06 Wrangler, Each

13550.01

WARNING:

Loss of vehicle control involves risk of death or serious injury, particularly to parts of your body not restrained within vehicle. This product is intended for weather protection only and should not be relied upon to contain occupants in the event of an accident or to protect from either ground contact or falling objects. To reduce risk of accident injury:

- Always wear seat belts.

- Read and follow all instructions and warnings accompanying this product, in vehicle owners manual and Off Road Driving Supplement.

All images are subject to be representative. More detailed information is available online.



Bestop
Fit. Function. Style.



REPLACE-A-TOP™ FOR JEEP®

Replace-A-Top™ for Jeep®

| | Part # |
|--|----------|
| 97-02 Wrangler With Full Steel Doors, Black | 51127-15 |
| 97-02 Wrangler With Full Steel Doors, Dark Tan | 51127-33 |
| 97-02 Wrangler With Full Steel Doors, Spice | 51127-37 |
| 88-95 Wrangler, Gray, Tinted | 51123-09 |
| 88-95 Wrangler, Black Denim, Tinted | 51123-15 |
| 88-95 Wrangler, Spice, Tinted | 51123-37 |
| 88-95 Wrangler, Black Denim | 51120-15 |
| 88-95 Wrangler, Spice | 51120-37 |



SUPERTOP™ FOR JEEP®

Supertop for Jeep®

| | Part # |
|--|----------|
| 07-12 Wrangler, 2 Door, Black Diamond | 54716-35 |
| 76-95 CJ7/YJ, Black | 51599-01 |
| 76-95 CJ7/YJ, Black Denim | 51599-15 |
| 76-95 CJ7/YJ, Spice | 51599-37 |
| 76-83 CJ5, Black | 51597-01 |
| 76-83 CJ5, Tan | 51597-04 |
| 76-83 CJ5, Black Denim | 51597-15 |
| 55-75 CJ5, Black | 51595-01 |
| Supertop NX, 07-12 Wrangler 4-Door, Black Diamond NEW | 54723-35 |
| Supertop NX, 07-12 Wrangler 4-Door, Dark Khaki NEW | 54723-36 |
| Supertop NX, 04-06 Wrangler Unlimited (LJ), Black Diamond NEW | 54721-35 |



BIKINI® TOPS

Bikini® Tops

| | Part # |
|---|----------|
| 07-09 Wrangler, Header Safari Bikini Top, Mesh | 52581-11 |
| 07-09 Wrangler, Header Safari Bikini Top, Black Diamond | 52581-35 |
| 07-09 Wrangler, Header Safari Bikini Top, Khaki Diamond | 52581-36 |
| 04-06 Wrangler, Header Safari Bikini Top, Black Diamond | 52544-35 |
| 97-02 Wrangler, Header Bikini, Mesh | 52525-11 |
| 97-02 Wrangler, Header Bikini, Black Denim | 52525-15 |
| 97-02 Wrangler, Header Bikini, Spice | 52525-37 |
| 97-02 Wrangler, Header Safari Bikini Top, Color Matched <small>Requires Installation Of 51238 No Drill Mesh</small> | 52531-11 |
| 97-02 Wrangler, Header Safari Bikini Top, Black Denim | 52531-15 |
| 97-02 Wrangler, Header Safari Bikini Top, Spice | 52531-37 |
| 92-95 Wrangler YJ, Strapless, Gray | 52519-09 |
| 92-95 Wrangler YJ, Strapless, Black Denim | 52519-15 |
| 92-95 Wrangler YJ, Strapless, Spice | 52519-37 |
| 92-95 Wrangler, Safari, Gray | 52529-09 |
| 92-95 Wrangler, Safari, Black Denim | 52529-15 |
| 92-95 Wrangler, Safari, Spice | 52529-37 |
| 88-83 CJ-5, Strapless Bikini, Black | 52517-01 |
| 76-91 Jeep® CJ-7, CJ-8 Scrambler & Wrangler YJ, Black | 52508-01 |
| 76-91 Jeep® CJ-7, CJ-8 Scrambler & Wrangler YJ, Tan | 52508-04 |
| 76-91 Jeep® CJ-7, CJ-8 Scrambler & Wrangler YJ, Gray | 52508-09 |
| 76-91 Jeep® CJ-7, CJ-8 Scrambler & Wrangler YJ, Mesh Material | 52508-11 |
| 55-75 Jeep® CJ-5, CJ-6 & M-38A1, Black | 52505-01 |
| 55-75 Jeep® CJ-5, CJ-6 & M-38A1, Tan | 52505-04 |
| 86-94 Suzuki Samurai, Strapless Bikini, Black | 52561-01 |
| 86-94 Suzuki Samurai, Strapless Bikini, Black Denim | 52561-15 |





TREKTOP™ FOR JEEP®

Trektop™

| |
|---|
| Trektop NX, 07-12 Wrangler, 4-Door, Black Diamond NEW |
| Trektop 07-12 Wrangler, 4-Door, Black Diamond |
| Trektop NX, 04-06 Wrangler Unlimited (LJ), Black Diamond NEW |
| Trektop 04-06 Wrangler Unlimited (TJ), Black Diamond |

Part

| |
|----------|
| 56823-35 |
| 56805-35 |
| 56821-35 |
| 56802-35 |



WINDJAMMER™

Windjammer™

| |
|--|
| 97-99 Wrangler, Black Denim |
| 97-99 Wrangler, Spice |
| 03-06 Wrangler & Wrangler Unlimited, Black Diamond |

Part

| |
|----------|
| 80030-15 |
| 80030-37 |
| 80032-35 |



DUSTER™ DECK COVERS

Duster™ Deck Covers

| |
|--|
| 07-12 Wrangler, 2 Door, With Hard Top, Black Diamond |
| 07-12 Wrangler, 2 Door, With Hard Top, Khaki Diamond |
| 03-06 Wrangler, With Soft Top, Black Diamond |
| 03-06 Wrangler, With Soft Top, Khaki Diamond |
| 03-06 Wrangler, With Hard Top, Black Diamond |
| 03-06 Wrangler, With Hard Top, Khaki Diamond |

Part

| |
|----------|
| 90033-35 |
| 90033-36 |
| 90012-35 |
| 90012-36 |
| 90022-35 |
| 90022-36 |



DOOR SKINS

Fabric Door Skins

| |
|-------------------------------|
| 97-06 Wrangler, Black Denim |
| 97-04 Wrangler, Black Diamond |

Part

| |
|----------|
| 53121-15 |
| 53121-35 |



TIGERTOP™

Tigertops

| |
|------------------------------|
| 50-52 M38, 48-53 CJ3A, Black |
|------------------------------|

Part

| |
|----------|
| 51403-01 |
|----------|



QUICK RELEASE KNUCKLES

Soft Top Quick Release Knuckles

| |
|--|
| Jeep® Wrangler (TJ) 97-06, (JK) 07-12 NEW |
|--|

Part

| |
|----------|
| 51290-01 |
|----------|



CHEVY



DODGE



FORD



REAR



NOW AVAILABLE!
A complete line of the most popular applications for custom fit front & rear liners for truck, suv & mini-vans!

Rugged Ridge® All Terrain Floor Liners



The only Floor Liners with Deep Tread Technology!

Rugged Ridge® All Terrain Floor Liners offer complete interior floor protection for your Truck, SUV or Jeep®. Now you can be assured when Rugged Ridge® All Terrain Floor Liners are installed, your investment is protected for the life of your vehicle. Rugged Ridge® All Terrain Floor Liners are essential for everyday use, at work, or when your vehicle is used for outdoor adventures. Keep your vehicle's carpet clean and free from harmful airborne contaminants when going through snow, dust, sand, or even when you decide to go play in the mud. We have you protected when its necessary to catch the second scoop of your little ones ice cream after the big game. No jobs too big with our 3/8" Deep Tread Technology chevron pattern floor liners, that are up to 3 times the depth of the other floor liners for maximum floor protection. Rugged Ridge® All Terrain Floor Liners are available for domestic and foreign vehicle manufactured applications.

Rugged Ridge® Floor Protection Benefits:

- Protect yourself from airborne contaminants such as soot, dirt, pollen, mold and other pollutants that enter a vehicle and stays in your vehicles carpet
- Improve the resale value of your vehicle by protecting your vehicles flooring from smells, faded and worn carpet, and costly repairs from captured moisture and salt in carpets that rust floor pans and corrodes wiring
- Perfectly contoured to your vehicle's floor for Form, Fit & Function
- Extra tall sides and 3/8" deep tread for extra protection
- Twice the thickness of other liners - "Dare to Compare"
- Nibbed bottoms and floor hook keeps liners safely in place
- Easily removable for quick cleaning
- Stain Resistant Thermoplastic Resin has far superior fit, quality and durability
- All Season protection for any element and climate
- Keeps carpet, footwear and clothing clean and dry
- A Floor Liner durable enough to outlast the vehicle
- Chevron Tread Pattern designed to channel debris and moisture away
- Limited Lifetime Warranty

DARE TO COMPARE DEEP TREAD TECHNOLOGY WITH VACUUM FORMED FLOOR LINERS!

We've compared typical vacuum formed floor liners with Rugged Ridge® Deep Tread Floor Liners and the differences are dramatic:

Rugged Ridge® Floor Liners

Typical Vacuum Formed Liners

Rolled reinforced edges provided added durability and a finished look

Typically, vacuum formed liners get thinner and weaker at the edges

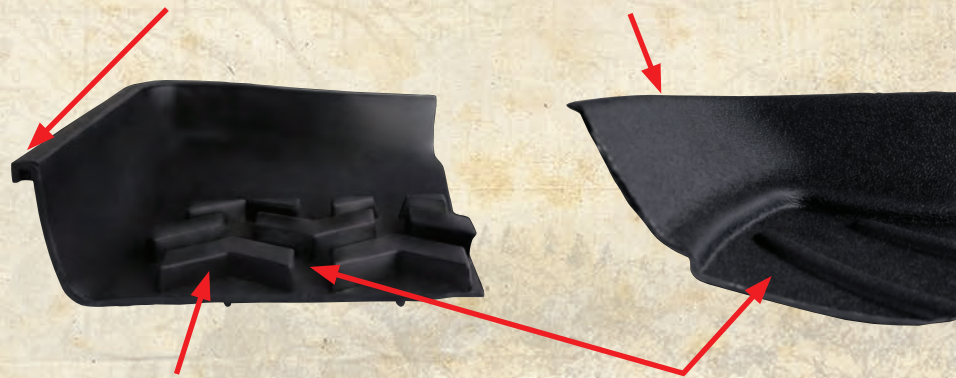

Chevron shaped raised pattern channels water and dirt away from your shoes and clothing

Rugged Ridge® All Terrain Floor Liners offer up to 3 times the height of regular vacuum formed floor liners

| Brand | Nibs on Back | Self Sealing Floor Hooks | 90° Rolled Edges | Fluid Containment | Interior Depth | Reinforced Heel Pad | Warranty |
|--|--------------|--------------------------|------------------|---------------------|----------------|---------------------|------------------|
| Rugged Ridge® All Terrain Floor Liners | Yes | Yes | Yes | Deep Tread | 3/8" | Yes | Limited Lifetime |
| Vacuum Molded A | No | No | No | Door Sill Spill Out | 1/8" | No | 3 Years |
| Vacuum Molded B | Yes | No | No | Puddle | 1/16" | No | Limited Lifetime |

Patented Product D627,285. More U.S. and Foreign Patents Pending

TRUCK FLOOR LINER APPLICATION CHART

| YEAR | MAKE/MODEL | Front | Universal 2nd Row | Custom 2nd Row |
|------------------|---|-----------|-------------------|----------------|
| CADILLAC | | | | |
| 02-06 | ESCALADE | 82901.02 | 82950.01 | - |
| 07-12 | ESCALADE | 82901.01 | 82950.01 | - |
| CHEVROLET | | | | |
| 02-06 | AVALANCHE NEW | 82901.02 | 82950.01 | 82951.10 |
| 07-12 | AVALANCHE | 82901.01 | 82950.01 | 82951.10 |
| 99-06 | SILVERADO 1500 CREW CAB NEW | 82901.02 | 82950.01 | 82951.10 |
| 07-12 | SILVERADO 1500 CREW CAB NEW | 82901.01 | 82950.01 | 82951.10 |
| 99-06 | SILVERADO 1500 EXT CAB NEW | 82901.02 | 82950.01 | 82951.10 |
| 07-12 | SILVERADO 1500 EXT CAB NEW | 82901.01 | 82950.01 | 82951.11 |
| 01-06 | SILVERADO 2500/3500 CREW CAB NEW | 82901.02 | 82950.01 | 82951.10 |
| 07-12 | SILVERADO 2500/3500 CREW CAB NEW | 82901.01 | 82950.01 | 82951.10 |
| 01-04 | SILVERADO 2500/3500 EXT CAB NEW | 82901.02 | 82950.01 | 82951.10 |
| 00-06 | SUBURBAN | 82901.02 | 82950.01 | - |
| 07-12 | SUBURBAN | 82901.01 | 82950.01 | - |
| 00-06 | TAHOE | 82901.02 | 82950.01 | - |
| 07-12 | TAHOE | 82901.01 | 82950.01 | - |
| DODGE | | | | |
| 02-12 | RAM 1500 QUAD CAB NEW | 82903.01 | 82950.01 | 82953.10 |
| 02-12 | RAM 1500 REG CAB | 82903.01 | - | - |
| 03-12 | RAM 2500/3500 QUAD CAB NEW | 82903.01 | 82950.01 | 82953.10 |
| 06-10 | RAM MEGA CAB | 82903.01 | 82950.01 | - |
| 09-12 | RAM 1500/2500/3500 CREW CAB NEW | 82903.04 | 82950.01 | 82953.10 |
| 07-12 | CALIBER NEW | 12920.30 | - | 12950.17 |
| 11-12 | DURANGO NEW | *12920.29 | 82950.01 | *12950.15 |
| FORD | | | | |
| 97-02 | EXPEDITION | 82902.05 | 82950.01 | - |
| 97-03 | F150 EXT CAB | 82902.04 | 82950.01 | 82952.11 |
| 04-08 | F150 EXT CAB | 82902.01 | 82950.01 | 82952.11 |
| 09-12 | F150 EXT CAB | 82902.03 | 82950.01 | - |
| 97-03 | F150 REG CAB | 82902.04 | - | - |
| 04-08 | F150 REG CAB | 82902.01 | - | - |
| 09-12 | F150 REG CAB | 82902.03 | - | - |
| 01-03 | F150 SUPER CREW | 82902.05 | 82950.01 | - |
| 04-08 | F150 SUPER CREW NEW | 82902.01 | 82950.01 | 82952.11 |
| 09-12 | F150 SUPER CREW NEW | 82902.03 | 82950.01 | 82952.12 |
| 99-07 | F250/F350 EXT CAB | 82902.07 | 82950.01 | - |
| 99-07 | F250/F350 REG CAB | 82902.07 | - | - |
| 99-07 | F250/F350 SUPER CREW NEW | 82902.07 | 82950.01 | 82952.13 |
| 08-10 | F250/F350 EXT CAB | 82902.06 | 82950.01 | - |
| 08-10 | F250/F350 REG CAB | 82902.06 | - | - |
| 08-10 | F250/F350 SUPER CREW NEW | 82902.06 | 82950.01 | 82952.13 |
| 11-12 | F250/F350 EXT CAB NEW | 82902.08 | 82950.01 | - |
| 11-12 | F250/F350 REG CAB NEW | 82902.08 | - | - |
| 11-12 | F250/F350 SUPER CREW NEW | 82902.08 | 82950.01 | 82952.13 |
| GM | | | | |
| 99-06 | SIERRA 1500 CREW CAB NEW | 82901.02 | 82950.01 | 82951.10 |
| 07-12 | SIERRA 1500 CREW CAB NEW | 82901.01 | 82950.01 | 82951.10 |
| 99-06 | SIERRA 1500 EXT CAB NEW | 82901.02 | 82950.01 | 82951.10 |
| 07-12 | SIERRA 1500 EXT CAB NEW | 82901.01 | 82950.01 | 82951.11 |
| 01-06 | SIERRA 2500/3500 CREW CAB NEW | 82901.02 | 82950.01 | 82951.10 |
| 07-12 | SIERRA 2500/3500 CREW CAB NEW | 82901.01 | 82950.01 | 82951.10 |
| 99-06 | SIERRA 2500/3500 EXT CAB NEW | 82901.02 | 82950.01 | 82951.10 |
| 00-06 | YUKON | 82901.02 | 82950.01 | - |
| 07-12 | YUKON | 82901.01 | 82950.01 | - |
| LINCOLN | | | | |
| 02-03 | BLACKWOOD | 82902.05 | 82950.01 | - |
| 06-08 | MARK LT | 82902.01 | 82950.01 | 82952.11 |
| 99-02 | NAVIGATOR | 82902.05 | 82950.01 | - |
| NISSAN | | | | |
| 05-12 | PATHFINDER NEW | 82905.10 | 82950.01 | - |
| 05-12 | XTERRA NEW | 82905.10 | 82950.01 | - |
| TOYOTA | | | | |
| 07-12 | FJ CRUISER NEW | 82904.30 | - | - |
| 05-12 | TACOMA REG CAB | 82904.10 | - | - |
| 05-12 | TACOMA ACCESS CAB | 82904.10 | 82950.01 | - |
| 05-12 | TACOMA DOUBLE CAB | 82904.10 | 82950.01 | - |
| 07-12 | TUNDRA REG CAB NEW | 82904.20 | - | - |
| 05-12 | TUNDRA DOUBLE CAB | 82904.10 | 82950.01 | - |
| 07-12 | TUNDRA CREWMAX NEW | 82904.20 | 82950.01 | - |

Accessories

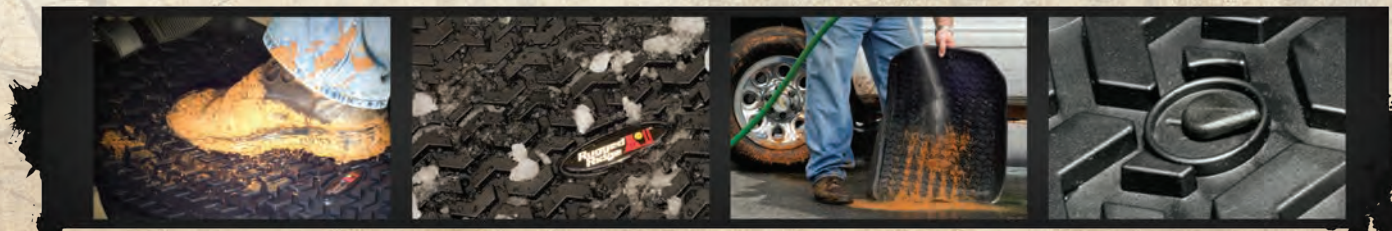

All images are subject to be representative. More detailed information is available online.



TOTAL PROTECTION FOR YOUR JEEP®!



The only floor liner with patented Deep Tread technology! These floor liners are a totally new concept that combines all the best features of deep ribbed floor mats and the old style liners. Precision engineering using state of the art technology ensures an exact fit to the shape and contour of your vehicle's floor. The deeply molded Chevron-shape tread pattern channels dirt, mud and snow away from the driver to keep shoes and pant legs clean, containing the movement and sloshing around of any trapped water. The high perimeter wall offers a large footprint and maximum interior protection and containment. Raised nibs on the bottom provides maximum retention and keeps the liner in place. The self-sealing floor hook attachment feature [where applicable] helps to prevent dirt and moisture from getting through. Easy to remove and clean. Simply hose them off and go!!!



CUSTOM FIT 2ND ROW, JEEP® WRANGLER 07-12
4-DOOR DOOR TO DOOR PROTECTION



OFFICIAL LICENSED PRODUCT

MOPAR, JEEP, DODGE, PLYMOUTH, RAM, and CHRYSLER vehicles, images and logos are trademarks of Chrysler Group LLC used under license to Omix-Ada®, © Chrysler Group LLC 2011



CUSTOM FIT JEEP® WRANGLER 07-12 2-DOOR & 4-DOOR



Licensed Jeep® Logo Cargo Liners and Floor Liners Available For 76-95 CJ7/8 and Wrangler

JEEP® FLOOR LINER APPLICATION CHART

| YEAR | MAKE/MODEL | Front | Universal 2nd Row | Custom 2nd Row | Cargo Liner | Jeep® Logo Front | Jeep® Logo Cargo Liner |
|-------|--------------------------------------|-----------|-------------------|----------------|-------------|------------------|------------------------|
| 76-87 | CJ7 & CJ8 | 12920.21 | - | - | 12975.11 | DMC-12920.22 | DMC-12975.22 |
| 87-95 | WRANGLER | 12920.21 | - | - | 12975.12 | DMC-12920.22 | DMC-12975.22 |
| 97-06 | WRANGLER | 12920.11 | 82950.01 | 12950.10 | 12975.11 | - | - |
| 07-10 | WRANGLER, 2 Dr | 12920.01 | 82950.01 | 12950.02 | 12975.01 | - | - |
| 11-12 | WRANGLER, 2 Dr *NEW | 12920.01 | 82950.01 | 12950.02 | *12975.03 | - | - |
| 07-10 | WRANGLER UNLIMITED, 4 Dr | 12920.01 | 82950.01 | 12950.01 | 12975.01 | - | - |
| 11-12 | WRANGLER UNLIMITED, 4 Dr *NEW | 12920.01 | 82950.01 | 12950.01 | *12975.03 | - | - |
| 84-01 | CHEROKEE *NEW | 12920.25 | 82950.01 | - | - | *DMC-12920.25 | - |
| 93-98 | GRAND CHEROKEE *NEW | 12920.26 | 82950.01 | - | - | *DMC-12920.26 | - |
| 99-04 | GRAND CHEROKEE *NEW | 12920.27 | 82950.01 | - | - | *DMC-12920.27 | - |
| 05-10 | GRAND CHEROKEE *NEW | *12920.28 | 82950.01 | - | - | - | - |
| 11-12 | GRAND CHEROKEE *NEW | *12920.29 | 82950.01 | 12950.15 | *12975.23 | - | - |
| 06-09 | COMMANDER *NEW | *12920.28 | 82950.01 | - | - | - | - |
| 07-12 | COMPASS ^{1,2,3} | 12920.30 | - | 12950.17 | 12975.25 | - | - |
| 07-12 | PATRIOT ^{1,2,3} | 12920.30 | - | 12950.17 | 12975.25 | - | - |
| 08-12 | LIBERTY ^{1,2,3} | 12920.31 | - | 12950.20 | 12975.27 | - | - |

1 Fronts Available 2012 2 Custom Rear Available 2012 3 Cargo Liner Available 2012



WARNING: Read and understand all instructions and related Warnings, Cautions and Notices before attempting to install or use your Rugged Ridge® winch.

RUGGED RIDGE® HEAVY DUTY 8,500 LB WINCH

- Durable 5.5 HP Series Wound motor for long life and extra pulling power
- Tough 3 stage planetary gear box with a 172.8:1 gear ratio delivering power and reliability
- Includes 94' of 5/16" diameter wire rope and latched hook
- Automatic load holding brake system (in the drum brake system)
- Exclusive light mount roller fairlead included- allows for easy no-drill mounting of up to 2 off road lights!
- Tough stainless hardware is used on the body of the winch to eliminate rust
- Each winch includes a durable 12' all weather cable remote solenoid box that can be mounted in multiple positions (over cable or over motor) and angles to accommodate most winch bumpers including the Rugged Ridge® XHD Bumper System!
- Limited 3 year warranty against manufacturing defects



EXCLUSIVE LIGHT MOUNT ROLLER FAIRLEAD INCLUDED WITH BOTH WIRE CABLE WINCHES

8,500LB LINE SPEED & AMP DRAW-FIRST LAYER for Wire Cable and Synthetic Rope Winches

| Line Pull | Lbs | No Load | 2000 | 4000 | 6000 | 8000 | 8500 |
|---------------|--------|---------|------|------|------|------|------|
| Line Speed | Ft/min | 37.2 | 18 | 13.1 | 10.2 | 8.2 | 7.2 |
| Motor Current | amps | 70 | 190 | 260 | 335 | 410 | 425 |



8,500 LB. Heavy Duty Winch with Steel Cable

Part #

8,500 LB Heavy Duty Winch with Steel Cable **NEW**

15100.01

RUGGED RIDGE® HEAVY DUTY 10,500 LB WINCH

ALL WEATHER 12' CABLE REMOTE INCLUDED WITH ALL WINCHES

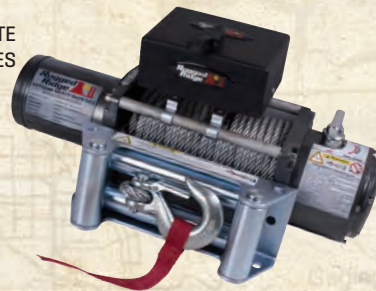

- Durable 6.6 HP Series Wound motor for long life and extra pulling power
- Tough 3 stage planetary gear box with a 218:1 gear ratio delivering power and reliability
- Includes 94' of 23/64" diameter wire rope and latched hook
- Automatic load holding brake system (in the drum brake system)
- Exclusive light mount roller fairlead included- allows for easy no-drill mounting of up to 2 off road lights!
- Tough stainless hardware is used on the body of the winch to eliminate rust
- Each winch includes a durable 12' all weather cable remote solenoid box that can be mounted in multiple positions (over cable or over motor) and angles to accommodate most winch bumpers including the Rugged Ridge® XHD Bumper System!
- Limited 3 year warranty against manufacturing defects

10,500LB LINE SPEED & AMP DRAW-FIRST LAYER for Wire Cable and Synthetic Rope Winches

| Line Pull | Lbs | No Load | 2000 | 4000 | 6000 | 8000 | 10500 |
|---------------|--------|---------|------|------|------|------|-------|
| Line Speed | Ft/min | 29.5 | 14.4 | 11.9 | 9.85 | 8.7 | 7.2 |
| Motor Current | amps | 70 | 170 | 240 | 310 | 380 | 425 |

10,500 LB. Heavy Duty Winch with Steel Cable

Part #

10,500 LB Heavy Duty Winch with Steel Cable **NEW**

15100.10



RUGGED RIDGE® SYNTHETIC ROPE PERFORMANCE WINCHES!

We have taken the high quality features of our regular winch and replaced the steel cable with genuine Dyneema SK-75 Synthetic Rope for a lighter weight, high performance winch option. The synthetic rope used on Rugged Ridge® winches is custom designed for heavy duty use and combined with the included polished aluminum hawse fairlead and 12' hook, will provide the ultimate in pulling power.

Rugged Ridge® 8,500 Synthetic Rope Winch- 11/32" x 100', Breaking Force 16,550lbs

- Constructed with Dyneema SK-75 fiber from the Netherlands.
- Same high strength fiber used in ballistic body armor.
- Significantly stronger than same diameter steel cable and up to 40% stronger than Kevlar.
- 1/7 the weight of the same diameter wire rope.
- Will not splinter, kink or curl like wire rope & floats in water.
- Specially coated to be resistant to UV, abrasions, and chemical solvents.
- Heavy Duty 11/32" 12-strand braid with a breaking force of 16,550lbs
- Hawse fairlead included



ALL WEATHER 12' CABLE REMOTE INCLUDED FOR ALL WINCHES

8,500 LB Performance Winch with Synthetic Rope

Part #

8,500 LB Performance Winch with Synthetic Rope **NEW**

15100.02

ALL RUGGED RIDGE® SYNTHETIC WINCHES INCLUDE AN ALUMINUM HAWSE FAIRLEAD



Rugged Ridge® 10,500 Synthetic Rope Winch-3/8" x 94', Breaking Force 19,310lbs

- Constructed with Dyneema SK-75 fiber from the Netherlands.
- Same high strength fiber used in ballistic body armor.
- Significantly stronger than same diameter steel cable and up to 40% stronger than Kevlar.
- 1/7 the weight of the same diameter wire rope.
- Will not splinter, kink or curl like wire rope & floats in water.
- Specially coated to be resistant to UV, abrasions, and chemical solvents.
- Heavy Duty 3/8" 12-strand braid with a breaking force of 19,310lbs
- Protective sleeves keep line from overheating on winch drum.
- Hawse fairlead included

10,500 LB Performance Winch with Synthetic Rope

Part #

10,500 LB Performance Winch with Synthetic Rope **NEW**

15100.11

All images are subject to be representative. More detailed information is available online.



WARNING: Read and understand all instructions and related Warnings, Cautions and Notices before attempting to install or use your Rugged Ridge® winch.



SYNTHETIC WINCH ROPE

Stronger and lighter, the two key elements of Synthetic Rope that make it the choice of competition off road vehicles everywhere. Rugged Ridge® high strength synthetic Winch Rope is constructed from genuine Dyneema SK-75 fiber imported from the Netherlands. This revolutionary fiber is the choice of off-road enthusiast worldwide. It is stronger and lighter than wire rope and never kinks or splinters! Our synthetic line is woven from twelve UV-treated strands, resulting in increased strength, and a power to weight ratio unmatched by wire rope. Each synthetic rope comes with a protective sleeve that prevents it from over heating on the winch drum, black powder coated latched hook, stainless steel thimble, and is pre-terminated end for ease of installation. Synthetic rope does not store energy like steel cables, and in the event of a failure it is much less likely to result in severe injuries caused by the whiplash of broken wire rope.



Synthetic Winch Rope Part #

| | |
|---|----------|
| Synthetic Winch Rope 11/32" x 100', Breaking Force of 16,550 lbs, Each NEW | 15102.10 |
| Synthetic Winch Rope 3/8" x 94', Breaking Force of 19,310 lbs, Each NEW | 15102.11 |

WINCH COVER

Keep your winch looking as good as the day you bought it with the Rugged Ridge® winch cover. Constructed of durable vinyl with reinforced grommets. Custom fit for Rugged Ridge® Winches



Rugged Ridge® Winch Cover Part #

| | |
|---|----------|
| Winch Cover, All Rugged Ridge® Winches NEW | 15102.02 |
|---|----------|

*Will not fit UTV winches

ALUMINUM HAWSE FAIRLEAD

This hawse fairlead will help guide the synthetic winch rope to and from the spool. Required for synthetic rope. Not recommended for steel rope.



Aluminum Hawse Fairlead Part #

| | |
|------------------------------------|----------|
| Aluminum Hawse Fairlead, 10", Each | 11238.01 |
|------------------------------------|----------|



WINCH CABLE HANDLE



The winch hook handle is the perfect solution for handling a winch cable. It is constructed of tough nylon webbing with a molded sure-grip handle. Perfect for getting a good solid grip of the winch hook when free spooling cable for a recovery and a safe way to respool your cable without endangering your fingers. Just slip your winch hook through the nylon webbing and you are ready to rock!



Winch Cable Handle Part #

| | |
|-------------------------------------|----------|
| Winch Cable Handle, Each NEW | 11238.01 |
|-------------------------------------|----------|

WINCH CABLE STOPPER



Winch Cable Stopper Part #

| | |
|---|----------|
| Red, with Steel Cable or Synthetic Rope, Universal Application NEW | 15102.05 |
|---|----------|

| | |
|---|----------|
| Black, with Steel Cable or Synthetic Rope, Universal Application NEW | 15102.06 |
|---|----------|

LIGHT MOUNT ROLLER FAIRLEAD

Turn your roller fairlead into an off road light mount! This revolutionary new design allows for two off road lights to be easily mounted while not interfering with the winch operation.



Light Mount Roller Fairlead Part #

| | |
|--|----------|
| Light Mount Roller Fairlead, Each NEW | 15102.01 |
|--|----------|

ROLLER FAIRLEAD LICENSE PLATE HOLDER

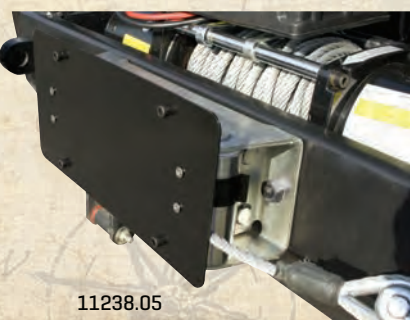

11238.05

If your state requires a front license plate, we have a solution for you. Instead of drilling holes in your bumper or risking not running a front plate, this easy to install license plate holder attaches to your winch roller fairlead. Simply bolt your license plate to the bracket and snap the holder in place. Your license plate is now securely mounted yet easily removable for winching.

Roller Fairlead License Plate Holder Part #

| | |
|---|----------|
| Roller Fairlead License Plate Holder, Each NEW | 11238.05 |
|---|----------|



DUAL BATTERY TRAY

Outfitting a trail rig can add greater strain to the electrical system. Adding on a winch, air compressor, fog lights, driving lights, a spot light, electric fuel pump, and a stereo amp can really tax the battery. A great way to combat that strain to install dual batteries. This is especially true when using a winch, which can draw big amps for an extended period. These kits are designed to mount two batteries in place of the factory single battery location. The trays and brackets feature a black powder coated finish. These are mounting kits only and do not include any wiring. A suggested wiring diagram is included. The kit places the batteries side-by-side and may be used with lead acid or cylindrical-style sealed gel cell batteries.

Rugged Ridge® Dual Battery Tray Part #

| | |
|---------------------------------|----------|
| 07-11 Jeep® Wrangler NEW | 11214.53 |
|---------------------------------|----------|

| | |
|---------------------------------|----------|
| 97-06 Jeep® Wrangler NEW | 11214.52 |
|---------------------------------|----------|

| | |
|---------------------------------|----------|
| 91-95 Jeep® Wrangler NEW | 11214.51 |
|---------------------------------|----------|

| | |
|------------------------------------|----------|
| 70-90 Jeep® CJ/Wrangler NEW | 11214.50 |
|------------------------------------|----------|

DUAL BATTERY RELAY KIT

The Rugged Ridge® Dual Battery Relay Kit is the perfect companion to the Rugged Dual Battery Tray. This relay kit allows you to connect two batteries to your electrical system. Includes the solenoid, a three position switch, battery cables, jumper cable, wiring harness and hardware.



Rugged Ridge® Dual Battery Relay Kit Part #

| | |
|------------------------------------|----------|
| 70-11 Jeep® CJ/Wrangler NEW | 17265.01 |
|------------------------------------|----------|

WARNING: Read and understand all instructions and related Warnings, Cautions and Notices before attempting to install or use your Rugged Ridge® winch.

RECOVERY GEAR

20,000 lbs Kit (Great for Jeep®)

- Durable Recovery Gear Bag.
- Heavy Duty 8" 20,000lb Snatch Block Pulley.
- Premium 2" x 30' 20,000lb Recovery Strap.
- Premium 3" x 6' 30,000lb Tree Trunk Protector Strap.
- Heavy Duty 9,500lb zinc coated pair of D-Rings.
- Winch Line Dampener.
- Pair of Leather Recovery Gloves.

30,000 lbs Kit (Great for trucks)

- Durable Recovery Gear Bag.
- Heavy Duty 9" 30,000lb Snatch Block Pulley.
- Premium 3" x 30' 30,000lb Recovery Strap.
- Premium 3" x 6' 30,000lb Tree Trunk Protector Strap.
- Heavy Duty 13,500lb zinc coated pair of D-Rings.
- Winch Line Dampener.
- Pair of Leather Recovery Gloves.

The Rugged Ridge® Recovery Kit includes everything you need to help your buddy next time he gets stuck in the mud. The durable carrying case is filled with our most popular recovery products to make sure you can get out of those trouble spots quickly and safely. Each kit contains the following:



NEW!

Recovery Gear also sold separately.

Rugged Ridge® Recovery Gear Kit

Part #

| | |
|--|----------|
| 20,000 lb, Recovery Gear, Kit, Universal Application | 12680.36 |
| 30,000 lb, XHD Recovery Gear Kit, Universal Application NEW | 15104.28 |

Don't Need Everything In Our Recovery Kit? Customize Your Your Own And Get Just What You Need!

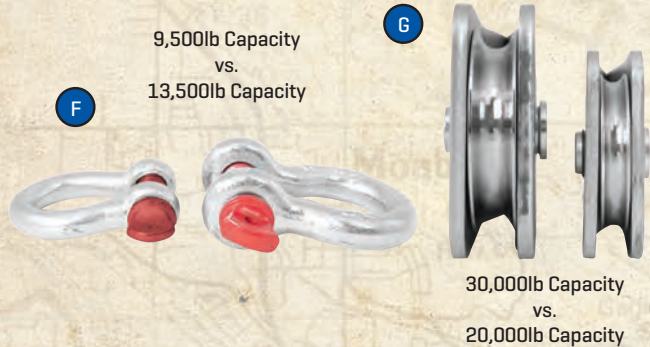

Rugged Ridge® Recovery Gear

Part #

| | |
|--|----------|
| A Recovery Strap 3" x 30' 30,000 lbs, Each NEW | 15104.01 |
| A Recovery Strap 2" x 30' 20,000 lbs, Each NEW | 15104.02 |
| A Recovery Strap 4" x 30' 40,000 lbs, Each NEW | 15104.03 |
| B Tree Trunk Protector, 3" x 6' 30,000 lbs, Each NEW | 15104.10 |
| B Tree Trunk Protector, 2" x 6' 20,000 lbs, Each NEW | 15104.11 |
| C Recovery Bag, Each NEW | 15104.40 |
| D Recovery Gloves, Pair NEW | 15104.41 |
| E Winch Line Dampener, Each NEW | 15104.43 |
| F Heavy Duty 9,500 lb Zinc Coated D-Rings, Pair NEW | 11235.01 |
| F Heavy Duty 13,500 lb Zinc Coated D-Rings, Pair NEW | 11235.03 |
| G Heavy Duty 8" 20,000 lb Snatch Block Pulley, Each NEW | 11235.10 |
| G Heavy Duty 9" 30,000 lb Snatch Block Pulley, Each NEW | 11235.11 |

TIRE REPAIR KIT

The Rugged Ridge® Tire Repair Kit is essential recovery gear for any road or trailside tire repair. The kit includes: 2 sturdy aluminum handles, 2 reamers, 2 needles, 2 Allen head wrenches, and 25 self vulcanizing tire plugs all self contained in a heavy duty storage case. Be prepared for what ever the trail throws at you!



Rugged Ridge® Tire Repair Kit

Part #

| | |
|----------------------------------|----------|
| Tire Repair Kit, Each NEW | 15104.51 |
|----------------------------------|----------|

OFF ROAD JACK HANDLE RETAINER STRAP

This handy Off Road Jack Handle Retainer Strap pulls taut to secure the jack handle to the jack and eliminates obnoxious rattles. Simply loop the strap around the jack handle and pull it tight and go! Fits most off road style farm jacks including Hi-Lift.



Off Road Jack Handle Retainer Strap

Part #

| | |
|---|----------|
| Universal Application, Black NEW | 13305.60 |
|---|----------|

TIRE DEFLATOR KITS

Fully inflated tires are great for the road and gas mileage, but they deliver a washboard ride on the trail. Air down your tires for a softer ride and more tread grip. Rugged Ridge® offers two great kits to fit your lifestyle and budget. Made from 100% brass and are fully adjustable in 3 psi. increments. Once you find your desired setting you can lock the deflators where they bleed to the same tire pressure each and every time they are installed. So, you can deflate your tires quickly before heading out on the trail.



Rugged Ridge® Tire Deflator Kits

Part #

| | |
|--|----------|
| Adjustable Tire Deflator Kit, 4 Piece Kit NEW | 15104.53 |
| Keychain Tire Deflator Kit, 4 Pieces | 15104.50 |



TRI FOLD RECOVERY SHOVEL

The Rugged Ridge® Tri Fold Recovery Shovel is a fully functional collapsible shovel that features two serrated edges for cutting or digging. The heavy duty black powder coated body is 23 inches when open and folds to a mere 9 inches. It can be stowed easily in any vehicle, but is still rugged enough for the toughest of jobs. Includes durable storage case.

Rugged Ridge® Tri Fold Off Road Shovel

Part #

| | |
|--------------------------------|----------|
| Tri Fold Off Road Shovel, Each | 15104.42 |
|--------------------------------|----------|

All images are subject to be representative. More detailed information is available online.

MANUAL LOCKING HUBS

Knee deep in mud with a failed automatic hub and a disabled vehicle? The only way to repair it is to replace it. The question is, with what? Factory automatic hubs have a history of failing when you need them most. A damaged hub will render your 4x4 useless and leave you stranded. Wish you could swap your venerable automatic hubs to a set of manual locking hubs? Rugged Ridge® has heard your plea. Rugged Ridge® Manual Locking Hubs are unanimously recognized as the world's toughest hubs by our thousands of satisfied customers worldwide. Brute strength matters, that is why the bodies of our hubs are crafted from impact resistant nodular iron, and feature a corrosion resistant die cast aluminum cap. Our hubs deliver better 4WD performance when locked and improved fuel economy in 2WD when unlocked, than automatic hubs. Purchasing a set a premium manual hubs is more cost effective than servicing your worn factory hubs. With the money you save you'll be able to carry a spare set, not that you'll need them. Sure you have to get out of the cab to lock the hubs, but unlike automatic hubs you won't have to wait until you lose traction for your four-wheel drive to engage.

Rugged Ridge® Premium Hubs Feature:

- A full metal cap and body crafted from impact resistant nodular iron.
- Corrosion resistant die cast aluminum caps coated with high luster epoxy enamel for along lasting finish.
- Better 4WD performance when the manual hubs are locked. Works in reverse and compression braking.
- No slippage or partial engagement / disengagement issues that plague automatic hubs.
- Better fuel economy by freewheeling in 2WD mode. Great for any "tow vehicle".
- Decreases wear on internal components by engaging 4WD only when needed.
- More durable and cost effective than replacing or servicing automatic hubs.
- Ridiculously simple installation. Your average installation is completed in less than 20 minutes.
- Manual hubs offer extra gear ranges. By unlocking your hubs and driving in 4WD mode, you gain use of 2WD Low and 2WD High ranges.
- 1998-00 Ford Ranger [15001.70] application is exclusively available from Rugged Ridge®!



Accessories

| Make/ Model | Years | Part # | Spline Count | Bolt Count | Make/ Model | Years | Part # | Spline Count | Bolt Count |
|---|---------|------------|--------------|--------------|------------------------------------|-------|------------|--------------|--------------|
| Chevrolet / GMC | | | | | Jeep® | | | | |
| Blazer, Jimmy, Suburban | 69-91** | 15001.18 * | 19 | Internal Mt. | Willys CJ2A | 45-49 | 15001.01 | 10 | 6 |
| 1/2 Ton Pickup Truck | 69-87 | 15001.18 * | 19 | Internal Mt. | Willys CJ3A | 48-53 | 15001.01 | 10 | 6 |
| 3/4 Ton Pickup Truck | 60-76 | 15001.17 | 19 | 6 | Willys CJ3B | 53-67 | 15001.01 | 10 | 6 |
| 3/4 Ton Pickup Truck | 77-87 | 15001.18 * | 19 | Internal Mt. | Willys M38A1 | 52-71 | 15001.01 | 10 | 6 |
| 1 Ton Pickup Truck | 76-91** | 15001.39 | 30 | Internal Mt. | CJ5 & CJ6 | 55-71 | 15001.01 | 10 | 6 |
| Geo Tracker | 89-98 | 15001.38 | 26 | 6 | CJ5, CJ6, CJ7 | 72-80 | 15001.02 | 27 | 6 |
| Grand Vitara | 99-04 | 15001.38 | 26 | 6 | CJ7 & CJ8 | 81-86 | 15001.26 | 27 | 5 |
| Dodge / Chrysler | | | | | Jeepster Commando C101 | | | | |
| 1/2 Ton Pickup Truck | 47-68 | 15001.17 | 19 | 6 | Jeepster Commando C104 | 66-71 | 15001.01 | 10 | 6 |
| 1/2 Ton Pickup Truck & Ramcharger | 69-75 | 15001.18 * | 19 | Internal Mt. | Wagoneer & Gladiator | 72-73 | 15001.02 | 27 | 6 |
| 3/4 Ton Pickup Truck | 57-75 | 15001.17 | 19 | 6 | Wagoneer & Cherokee [SJ] | 63-73 | 15001.01 | 10 | 6 |
| Power Wagon WC-50 & WC-60 | 42-56 | 15001.08 | 16 | 6 | J-10 Pickup | 74-91 | 15001.18 * | 19 | Internal Mt. |
| 1/2 Ton Pickup Truck & Ramcharger | 80-93 | 15001.18 * | 19 | Internal Mt. | J-20 Pickup | 74-91 | 15001.18 * | 19 | Internal Mt. |
| 3/4 Ton Pickup Truck & Ramcharger | 80-93 | 15001.18 * | 19 | Internal Mt. | J-20 Pickup | 77-87 | 15001.18 * | 19 | Internal Mt. |
| 3/4 Ton Pickup Truck | 90-93 | 15001.39 | 30 | Internal Mt. | Mazda | | | | |
| 1 Ton Pickup Truck w/Dana 60 | 90-93 | 15001.39 | 30 | Internal Mt. | B3000 & B4000 | 01-08 | 15001.70 | 27 | Internal Mt. |
| Raider | 87-89 | 15001.43 | 28 | 6 | Navajo | 90-94 | 15001.65 | 27 | 5 |
| Ford | | | | | Pickup Truck | 94-97 | 15001.65 | 27 | 5 |
| Bronco [Except Bronco II] | 66-96 | 15001.18 * | 19 | Internal Mt. | Mitsubishi | | | | |
| F100 1/2 Ton | 59-86 | 15001.18 * | 19 | Internal Mt. | Montero | 82-92 | 15001.43 | 28 | 6 |
| F150 1/2 Ton | 59-96 | 15001.18 * | 19 | Internal Mt. | Nissan | | | | |
| F250 3/4 Ton w/Dana 44 | 59-75 | 15001.18 * | 19 | Internal Mt. | Patrol | 80-87 | 15001.23 | 29 | 6 |
| F250 3/4 Ton w/Dana 44HD | 63-77 | 15001.17 | 19 | 6 | Patrol | 90-94 | 15001.45 | 31 | 6 |
| F250 3/4 Ton w/Dana 44 | 78-86 | 15001.18 * | 19 | Internal Mt. | Pickup Truck | 86-93 | 15001.29 | 27 | 6 |
| F250 3/4 Ton w/Dana 60 | 78-96 | 15001.39 | 30 | Internal Mt. | Frontier V6 | 90-01 | 15001.61 | 28 | 6 |
| F350 1 Ton | 76-97 | 15001.39 | 30 | Internal Mt. | Pathfinder | 86-89 | 15001.29 | 27 | 6 |
| F450 & F350 Super Duty | 99-04 | 15001.39 | 30 | Internal Mt. | Pathfinder V6 | 90-01 | 15001.61 | 28 | 6 |
| Ranger | 98-00 | 15001.70 | 27 | Internal Mt. | Xterra | 00-04 | 15001.61 | 28 | 6 |
| Ranger | 90-97 | 15001.65 | 27 | Internal Mt. | Suzuki Sidekick/Geo Tracker | | | | |
| Explorer | 90-94 | 15001.65 | 27 | Internal Mt. | Samurai & Sierra | 82-94 | 15001.38 | 26 | 6 |
| Ranger Auto to Manual Hub Conversion*** | 90-97 | 15001.65 | 27 | Internal Mt. | Sidekick & Vitara | 89-04 | 15001.38 | 26 | 6 |
| Ranger & Bronco II | 83-89 | 15001.67 | 23 | 5 | Toyota | | | | |
| International | | | | | Pickup Truck | 76-85 | 15001.21 | 30 | 6 |
| Scout | 60-71 | 15001.01 | 10 | 6 | 4 Runner | 76-85 | 15001.21 | 30 | 6 |
| Scout II, Terra, Traveler | 72-80 | 15001.02 | 27 | 6 | Pickup Truck, T100 | 86-00 | 15001.13 | 26 | 6 |
| 1/2 Ton Pickup Truck | 56-67 | 15001.17 | 19 | 6 | 4 Runner | 86-95 | 15001.13 | 26 | 6 |
| 3/4 Ton Pickup Truck | 56-67 | 15001.17 | 19 | 6 | Tacoma*** | 95-00 | 15001.13 | 26 | 6 |
| 1/2 Ton Pickup Truck | 68-75 | 15001.18 * | 19 | Internal Mt. | Dana 70 | | | | |
| Travelall | 68-75 | 15001.18 * | 19 | Internal Mt. | Dana 70 Hub | | 15001.97 | 35 | Internal Mt. |
| Isuzu | | | | | Other Components | | | | |
| Trooper II | 87-99 | 15001.33 | 17 | 6 | Service Kit for 15001.65 Hub | | 15002.65 | | |
| Rodeo | 91-99 | 15001.33 | 17 | 6 | Service Kit for 15001.18 Hub | | 15002.18 | | |
| Amigo | 91-99 | 15001.33 | 17 | 6 | | | | | |

* Some models converting from automatic hubs may require service kit for installation.

** All Chevrolet pickup trucks built in 1988 were equipped with an automatic hub system which cannot be converted.

***[Replaces OE manual hubs]

HID LIGHTING

We mated the brilliance of High Intensity Discharge bulbs with the rugged construction of our traditional halogen off road lights. The result is more efficient and powerful beam better capable of illuminating the night sky. HID lights are 2½ times more powerful than halogen lights and draw 60% less current than a standard 100W fog light. Our 6" and 5" HID Lights are constructed with heavy duty stamped steel housings, and are available in corrosion resistant black or stainless steel finish. Rugged Ridge® lights feature waterproof connections, internal ballast, and a reinforced multi-directional mounting base. The lights are available individually or in kits containing a pre-terminated wiring harness, relay, impact resistant stone guards and illuminated dash switch.

- 5", 6", 7" HID light assemblies available.
- 12V 35W 4200K HID Bulb.
- Internal ballast - no external ignition ballast to install.
- 2½ times more powerful than halogen bulbs.
- Draws 60% less current than a standard 100W fog light.
- HID Lights include impact resistant stone guard.
- The average life of an HID bulb is 2000 hours, compared to 500-1000 hours for a halogen unit.



Lights are available individually. All include impact resistant stone guards

Kits include a pre-terminated wiring harness, relay and illuminated dash switch



15205.51



15206.01



15205.63

| HID Off Road Lighting | Single Light | 2 Light Kit w/ Wiring Harness | 3 Light Kit w/ Wiring Harness |
|--------------------------|--------------|-------------------------------|-------------------------------|
| 6" Round, Black | 15205.01 | 15205.51 | 15205.61 |
| 5" Round, Black | 15205.02 | 15205.52 | 15205.62 |
| 7" Round, Black, Plastic | 15205.03 | 15205.53 | 15205.63 |
| 5" Round, Black, Plastic | 15205.04 | 15205.54 | 15205.64 |
| 6" Round, Stainless | 15206.01 | 15206.51 | 15206.61 |
| 5" Round, Stainless | 15206.02 | 15206.52 | 15206.62 |

HALOGEN LIGHTING

Designed, engineered, and tested to stand up to the rigors of off road use, our lights are constructed with heavy-duty stamped steel housings, and crystal glass lenses set in shock absorbent weatherproof rubber gaskets. The brilliant 12V 100 watt halogen bulbs slice through fog, rain or snow to help illuminate the road even under the toughest conditions. Available in Round, Rectangular and Slim housings in either a black or stainless steel finish to best suit your application.

Slim lights feature a narrow profile just 2 13/16" thick! This sleek design allows them to be mounted in places most lights won't fit. They are perfect for windshield and grille mount light systems. The lights are available individually or in kits containing a pre-terminated wiring harness, relay, impact resistant stone guards [white stone guards with stainless, black with black] and illuminated dash switch.



15207.51

| Rugged Ridge® Off Road Lights, 100W | Single Light | 2 Light Kit w/ Wiring Harness | 3 Light Kit w/ Wiring Harness |
|-------------------------------------|--------------|-------------------------------|-------------------------------|
| 6" Round, Black | 15207.01 | 15207.51 | 15207.61 |
| 5" x 7", Black | 15207.05 | 15207.55 | 15207.65 |
| 6" Slim, Black | 15207.10 | 15207.58 | 15207.68 |
| 6" Round, Stainless | 15208.01 | 15208.51 | 15208.61 |
| 6" Slim, Stainless | 15208.10 | 15208.58 | 15208.68 |



Slim lights feature a narrow profile - just 2 13/16" thick!

Rectangular lights give your vehicle a whole new look

| Halogen Light Accessories | Part # |
|---|----------|
| Off Road Light Cover, 6-Inch Black | 15210.53 |
| Off Road Light Cover, 6-Inch White | 15210.54 |
| Off Road Light Cover, 5x7-Inch Black | 15210.55 |
| Off Road Light Cover, 5x7-Inch White | 15210.56 |
| Off Road Light Cover, 6-Inch Black Slim | 15210.57 |
| Off Road Light Cover, 6-Inch White Slim | 15210.58 |
| Off Road Light Installation Harness, For Pair Of Lights | 15210.62 |
| Off Road Light Installation Harness, For Three Lights | 15210.63 |
| Halogen H3 Off Road Light Bulb, 100w Replacement | 15210.82 |
| Halogen H3 Off Road Light Bulb, 130w Replacement | 15210.83 |

Crystal glass lenses set in shock absorbent weatherproof rubber gaskets.



Each lights includes an impact resistant stone guard.

Multi-directional mounting base allows you to focus light where you need it the most.

All images are subject to be representative. More detailed information is available online.

HID LIGHT ACCESSORIES

| Accessories/Replacement Parts | Part # |
|--|----------|
| HID Lighting Covers, 7", Smoked | 15210.51 |
| HID Lighting Covers, 6", Black | 15210.50 |
| HID Lighting Covers, 5", Black | 15210.52 |
| HID Lighting Installation Harness for a pair of lights | 15210.60 |
| HID Lighting Installation Harness for three lights | 15210.61 |
| Replacement HID Bulb for 5" and 6" lights | 15210.80 |
| Replacement HID Bulb for 7" lights | 15210.81 |

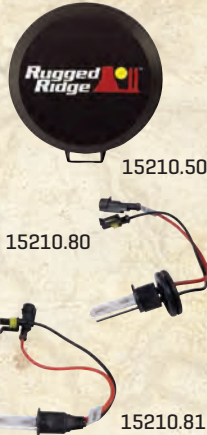

WINDSHIELD HINGE LIGHT BRACKETS

Special black powder coated or polished stainless brackets mount directly to the windshield hinge of your Wrangler. Allows for easy mounting of auxiliary lighting. Each bracket is custom designed for an exact mount and 07-12 models include a rubber gasket to protect the paint during installation/removal. Sold in pairs. Lights not included.



11027.03

| Windshield Hinge Light Brackets | Black | Stainless |
|---------------------------------|----------|-----------|
| 07-12 Wrangler NEW | 11027.03 | 11028.03 |

MOUNT A SET OF DRIVING LIGHTS ON YOUR HOOD CATCHES

Rugged Ridge® offers a complete light solution for your 2007-12 Jeep® Wrangler with our NEW Hood Mount Off Road Light Kit. This innovative product mounts a pair of 3" 55-watt Halogen Lights directly to your factory hood latches without drilling or vehicle modification. Each Kit includes textured black powder coated brackets, two 3" Halogen lights, a pre-terminated extended wiring harness, relay and an adhesive mounted switch for a complete light solution.



| Hood Mounted Off Road Light Kit 2007-12 Wrangler | Part # |
|---|----------|
| Off Road Lights, 3" Black, 2 Light Kit w/ Wiring Harness NEW | 15207.70 |

LED TAILLIGHTS FOR 1946-75 CJ AND 1976-06 CJ & WRANGLER

Replace your dim factory tail lights with our brilliant LED tail light assemblies and get noticed! Rugged Ridge® LED Tail Lights are DOT & SAE approved direct bolt in replacement tail lights, complete with impact resistant acrylic lenses, waterproof connections and polycarbonate housings. 1976-06 models feature 16 large brake, parking and directional LED's, 4 license plate light LED's and 22 brilliant white Back-Up LED's. While our 1946-75 units feature 9 large brake, parking and directional LED's, and 4 license plate light LED's. Our lights are Federal Regulation FMVSS108 compliant.

| LED Tail Lights for 1945-06 CJ & Wrangler | Part # |
|---|----------|
| LED Tail Light, LH, 76-06 Wrangler NEW | 12403.83 |
| LED Tail Light, RH, 76-06 Wrangler NEW | 12403.82 |
| LED Tail Light Pair, LH & RH, 76-06 Wrangler NEW | 12403.85 |
| LED Tail Light, LH, 46-75 CJ NEW | 12403.81 |
| LED Tail Light, RH, 46-75 CJ NEW | 12403.80 |
| LED Tail Light Pair, LH & RH, 46-75 CJ NEW | 12403.84 |



12403.83 for 1976-06 CJ/Wrangler Has 20 Large LED's



CRYSTAL HB2/H4 CONVERSION HEADLIGHT

Replace your old sealed beam bulb headlights with these Crystal H4 Conversion Headlights. This two-piece headlight and bulb is brighter, more economical and environmentally friendly than a conventional sealed beam headlight. The headlights and bulbs are SAE / DOT compliant.



| Crystal HB2/H4 Headlight | Part # |
|--|----------|
| Crystal HB2/H4 Headlight, 7 Inch Round, H2 Bulb, All [CJ] 55-86, [TJ] 97-06 and Various Non Jeep Applications, Pair, Includes Bulbs NEW | 12402.80 |
| 200mm Rectangular, H2 Bulb, [XJ] 84-01, [YJ] 87-95 and Various Non Jeep Applications, Pair, Includes Bulbs NEW | 12402.82 |

OE JK FOG LIGHT

Stock replacement lens and housing assembly. Fits either side.



| OE Fog Light | Part # |
|--|----------|
| Fog Light Assembly, Jeep Wrangler [JK] 07-10 LH/RH | 12407.12 |

ROCKER PANEL SWITCHES

Our marine grade switches are designed for use with Rugged Ridge® A-Pillar Pod and Switch Panels, but are sized to work in most OE dash switch blanks. Rugged Ridge® switches feature an OE fit, quality and function. They are available in Red, Blue, Green and Amber and the switch illuminates in the "ON" position. The three post 20-amp design is engineered for use with most aftermarket accessories. If you want to mount rocker switches to other locations like those pre-etched dash cutouts, the Rugged Ridge® housing kit allows you to mount 2, 3, or 4 switches to numerous dash locations by using a series of interlocking interchangeable pods. 3 Year limited warranty.

| Rocker Panel Switches | Part # |
|-----------------------|----------|
| Rocker Switch Amber | 17235.01 |
| Rocker Switch Red | 17235.02 |
| Rocker Switch Blue | 17235.03 |
| Rocker Switch Green | 17235.04 |



JK A-PILLAR SWITCH POD & KIT

Looking for a handy place to mount your accessory switches that doesn't require cutting or other modifications? The Rugged Ridge® A-Pillar Switch Pod has premolded cutouts to allow you to mount up to four aftermarket switches in easy reach on the driver's side A-pillar, and out of the way of the shifter handle. Our Pillar Pod has the textured molded finish just like the factory plastic pillar cover it replaces. It snaps into place just like the OE! A-Pillar Switch kit includes A-pillar Pod and one of each color Rocker Panel Switches.

| A-Pillar Switch Kit | Part # |
|--------------------------------------|----------|
| Wrangler 07-10 Left Side NEW | 17235.86 |
| Wrangler 07-10 Right Side NEW | 17235.87 |
| Wrangler 11-12 Left Side NEW | 17235.96 |
| Wrangler 11-12 Right Side NEW | 17235.97 |

| A-Pillar Switch Pod | Part # |
|--|----------|
| Black, Wrangler 07-10, Left Side NEW | 17235.56 |
| Black, Wrangler 07-10, Right Side NEW | 17235.57 |
| Black, Wrangler 11-12, Left Side NEW | 17235.58 |
| Black, Wrangler 11-12, Right Side NEW | 17235.59 |



JK LOWER CONSOLE SWITCH PANEL KIT

Rugged Ridge® Center Console Mount Switch Pod replaces your original equipment "filler plate" by simply popping the filler plate out and putting in the switch plate. Each plate will hold up to 4 switches and custom built for all 2007-2010 Jeep Wranglers with an automatic transmission. This exciting new mounting plate looks great and places auxiliary switches in easy reach. Purchase the Switch Panel and 4 multi color Rocker Switches all together and save [See kit part number below.] Limited 3 yr Warranty.



| Lower Console Switch Panel Kit | Part # |
|---|----------|
| 07-10 Wrangler w/ Automatic Transmission. Includes Switch Pod and Four Rocker Switches NEW | 17235.85 |

ROCKER SWITCH HOUSING KIT

This housing kit allows you to mount 2, 3, or 4 switches to numerous dash locations by using a series of interlocking interchangeable pods.



| Rocker Switch Housing Kit | Part # |
|--|----------|
| Mounts 2,3 OR 4 Switches | 17235.20 |
| Rocker Switch Housing Kit, Universal Application. Includes Four Interlocking Switch Housings and Four Different Color Rocker Switches NEW | 17235.89 |

TJ ROCKER SWITCH PODS



| Rocker Switch Pods | Part # |
|---|----------|
| AC Vent Switch Pod, Black, Mounts Two Switches, Jeep® Wrangler [TJ] 97-06 NEW | 17235.50 |
| AC Vent Switch Pod Kit, Black, Jeep Wrangler [TJ] 97-06, Includes Switch Pod & Two Rocker Switches (Amber & Red) NEW | 17235.80 |

JK LOWER CONSOLE SWITCH PANEL

Rugged Ridge Center Console Mount Switch Pod replaces your original equipment "filler plate" by simply popping the filler plate out and putting in the Switch Plate. Each plate holds up to 4 Switches. Custom built for all 2007-2010 Jeep Wranglers with an Automatic Transmission. Limited 3 year warranty.



| Lower Console Switch Panel Only | Part # |
|--|----------|
| 07-10 Wrangler w/ Automatic Transmission, Black, Mounts Four Switches NEW | 17235.55 |



FRONT BUMPER LIGHT BARS

Rugged Ridge® has engineered a durable and easy to install light bar that allows you to add auxiliary lighting to your factory Wrangler bumper. The light bar bolts to existing mounting holes and installs easily without cutting, drilling, or removing the bumper. With a few simple hand tools you will be able to install your light bar and mount up to three lights on your Jeep® while retaining your factory bumper. Lights not included.

| Front Bumper Light Bars | Part # |
|---------------------------------------|----------|
| 97-06 Wrangler, Textured Black, Each | 11232.02 |
| 97-06 Wrangler, Stainless Steel, Each | 11138.02 |
| 07-12 Wrangler, Textured Black, Each | 11232.20 |
| 07-12 Wrangler, Stainless Steel, Each | 11138.20 |



XHD OVERRIDER LIGHT CLAMPS

Light mount brackets for use with XHD part numbers 11540.14, 11540.16, 11541.14 and any other 2"-2.5" bumper override/tubes. Easy mount design makes these a must for mounting Rugged Ridge® Lights to your bumper. Also available for smaller 1.5"-1.75" tube sizes. Sold as eaches.

| Light Clamps | Part # |
|---|----------|
| 3" for Tubular Bumpers NEW | 11503.81 |
| 2"-2.5" NEW | 11503.82 |
| 1.5"-1.75" Sport Bar Light Mount Bracket NEW | 11503.83 |

JK WINDSHIELD LIGHT BAR

The Ultimate Light Bar for your Wrangler! This exciting new design has been created to give the durable look of a five tab light bar with features found nowhere else. Through extensive testing, this heavy duty light bar incorporates a special wind deflector below the light bar to dramatically reduce whistling and "buffeting" of your soft top. Each bar hugs the contour of your windshield providing a great look while not interfering with the use of your hard or soft top. Oversized 2" textured black tubing attaches to your windshield mounts with no drilling. Each Light bar has five light tabs for use with Rugged Ridge® Lighting options (fits up to five 7" lights). Each light bar has been specially developed to work with Rugged Ridge® Light mount brackets and/or Rugged Ridge® mirror relocation brackets. Special three piece design makes the packaging small for ease of shipping. This is truly the most advanced light bar on the market!



| Windshield Light Bar | Part # |
|---|----------|
| Textured Black, Jeep Wrangler [JK] 07-12, Each NEW | 11232.21 |

TJ WINDSHIELD LIGHT BAR

The three-piece light bar simplifies your installation dramatically because you won't run the risk of scratching up your windshield frame trying to mount a heavy one-piece bar with four lights onto your windshield hinges. With this bar you can install one piece at a time. The bar is available in stainless steel or black, and packaged in an easy to ship box for your convenience.



| TJ Light bars | Part # |
|---------------------------------------|----------|
| 97-06 Wrangler, Stainless Steel, Each | 11138.01 |
| 97-06 Wrangler, Black, Each | 11232.01 |

ALL TERRAIN FLAT FENDER FLARES

Now, with the NEW All Terrain Flat Fender Flares from Rugged Ridge® you can add a bigger tire option for a true off road look. You can also use in combination with a suspension lift for maximum off road performance. These exciting new flares are out-of-the-box ready to turn your street Jeep into an off road machine. By removing your original flares and replacing them with these high clearance designs, you can run larger tires without interference from the flare. The ability to run a larger tire with little or no suspension lift means a "lower center of gravity" making your JK more stable, yet you still get greater ground clearance necessary for off road. With 1.5 inches less coverage in the front and 1 inch less in the rear these flares are slightly narrower than factory, yet still maintain proper tire coverage and aggressive looks. Constructed of a flexible UV treated high impact thermoplastic, these flares are designed for the trail and create a whole new look for your JK. Easy to install, these flares replace your factory flares, attaching to the factory mounting points with no drilling. Simply remove your original flares and add on the All Terrain Flares. The kit also includes easy to install mounting brackets that allow you to relocate and use the existing factory side marker lights. The All Terrain Flat Fender Flare is the hottest looking, most functional Off Road Flare available for your JK! Finally, because no cutting or drilling is required, if you ever want to switch back to your original factory flares, there's no problem!



Special side marker light brackets included for use with your factory side marker light



All Terrain Flat Fender Flare Kit

| | Part # |
|--|----------|
| Flat Fender Flare Kit, 07-12 Wrangler 2 and 4-Door, 4 Pcs. | 11620.10 |
| Flat Fender Flare & Liner Kit, 07-12 Wrangler, 8 Pcs. NEW | 11620.11 |

*includes side marker light relocation brackets

ALL TERRAIN FLAT FENDER FLARE WHEEL LINER KIT

Designed for use in combination with the Rugged Ridge All Terrain Flat Flares for JK, PN: 11620.10, these wheel well liners help keep mud and debris out of the engine compartment and provide a clean finished look. Constructed from durable HDPE, the wheel liners replace the factory wheel well liners that must be removed when running aftermarket flares. Simple bolt in installation, no cutting or drilling required. Kit includes all four wheel well liners and mounting hardware.



Flare Wheel Liner Kit

| | Part # |
|-----------------------------------|----------|
| 07-12 Wrangler, 4 Pcs. NEW | 11620.50 |



ALL TERRAIN FENDER FLARES

Get that aggressive off road look with the NEW Rugged Ridge® All Terrain Fender Flare! These 6" flares feature a stylish design while protecting your vehicles paint from flying rocks and mud. Constructed of durable UV treated ABS with a slight texture, these paintable flares provide a great look while being able to handle whatever nature throws at them. Each All Terrain Flare is designed to fit factory mounting points [CJ and YJ designs require some drilling] with durable rust proof stainless fasteners. Each front flare uses your existing side marker lights by easily attaching to custom light cut-outs. Backed by an industry leading 3 year limited warranty, these NEW All Terrain Flares will really set you apart from the crowd!



11632.10 for 1987-95 Wrangler

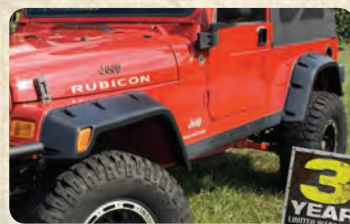

11630.10 for 1997-06 Wrangler/Unlimited



Custom designed for use with the factory side marker light

Special styling gives these flares that aggressive off road look



Stainless fasteners provide a great look and ease of installation

UV enhanced ABS design for long life and a great look

All Terrain Fender Flare Kits

| | Part # |
|---|----------|
| Fender Flare Kit w/ Hardware, 97-06 Wrangler/Wrangler Unlimited, 6 Pc. Kit NEW | 11630.10 |
| Fender Flare Kit w/ Hardware, 87-95 Wrangler*, 6 Pc. Kit NEW | 11632.10 |
| Fender Flare Kit w/ Hardware, 76-83 CJ5, 76-86 CJ7, 81-86 CJ8*, 4 Pc. Kit NEW | 11633.10 |
| Fender Flare Kit w/ Hardware 84-01 XJ 4-Door, NEW* | 11634.10 |
| Fender Flare Kit w/ Hardware 93-98 Z NEW** | 11635.10 |

* Some drilling required. **97-01 Cherokee may require modification to OE rear bumper cover

ALL TERRAIN TRUCK FENDER FLARES

Get that aggressive off road look with the NEW Rugged Ridge® All Terrain Fender Flare! Constructed of durable UV treated ABS with a matte finish, these paintable flares provide a great look while being able to handle whatever nature throws at them. Backed by an industry leading 3 year limited warranty.

All Terrain Truck Fender Flare

| | Part # |
|--|----------|
| 07-11 Chevy Silverado, 1500,2500HD,3500HD 78.7/97.6 Bed NEW | 81630.20 |
| 02-08 Dodge Ram 1500/2500/3500 All Beds NEW | 81630.40 |
| 06-08 Dodge Ram 1500/2500/3500 Short Bed NEW | 81630.40 |
| 09-11 Dodge Ram 1500 NEW | 81630.42 |
| 99-07 Ford F250, F350, & F450 SUPER DUTY NEW | 81630.01 |
| 08-10 Ford F250, F350 AND F450 SUPER DUTY NEW | 81630.02 |
| 04-08 Ford F150 EXCEPT FLARESIDE NEW | 81630.03 |



All images are subject to be representative. More detailed information is available online.



11607.01 Oversized 7" Flares, 87-95 Wrangler

11606.01 Oversized 7" Flares, 76-86 CJ

OVERSIZED 7" FLARES

Need a little extra coverage for those over sized tires? The Rugged Ridge® 7" Flare gives you the extra coverage you need while providing the clean look of original equipment designs. Each over sized flare is constructed of virtually indestructible UV treated thermoplastic to provide years of service. The special UV treatment put on each flare provides protection from sun fading. These flares are designed to bolt onto your vehicle but for CJ and 1987-95 Wrangler models, some vehicle modification may be necessary to truly cover those oversized tires. If you go off-road and need to protect your vehicle from rock chips and debris, look to Rugged Ridge® 7" oversized Fender Flares! Includes all mounting hardware.

Oversized 7" Fender Flares

| | Part # |
|--|----------|
| 76-86 CJ5, CJ7, CJ8, 4 Piece Kit w/all mounting hardware * | 11606.01 |
| 87-95 Wrangler, 6 Piece Kit w/all mounting hardware * | 11607.01 |
| 97-06 Wrangler, 6 Piece Kit w/all mounting hardware | 11608.01 |

* some trimming of the rear wheel well area is required to install oversized flares on CJ & YJ

Rugged Ridge® provides the most comprehensive replacement Fender Flare program on the market today. Covering model years starting in 1955 until current, Rugged Ridge® has you covered when it is time to replace or upgrade your Factory Fender Flares. Each Flare is constructed of virtually indestructible, durable, UV treated thermoplastic to provide years of service. Each replacement flare is designed to fit into your factory mounting holes [some models may require some hole relocation] for ease of installation. Just need to replace one flare? No problem. Rugged Ridge® offers individual replacements to keep your investment to a minimum.

REPLACEMENT FENDER FLARE KITS



11603.01 Replacement Fender Flare Kit, 97-06 Wrangler TJ

11601.01 Replacement Fender Flare Kit, 55-86 Jeep® CJ

11602.01 Replacement Fender Flare Kit, 87-95 Wrangler YJ



11601.01 Replacement Fender Flares, 55-86 Jeep® CJ

Accessories

| Complete Kit | Part # | Front Passenger | | Front Driver | | Rear Passenger | | Rear Driver | |
|---------------------|----------|-----------------|----------|--------------|----------|----------------|----------|-------------|----------|
| | | Part # | Part # | Part # | Part # | Part # | Part # | | |
| 07-12 Wrangler* | 11609.01 | Each | 11609.10 | Each | 11609.11 | Each | 11609.12 | Each | 11609.13 |
| 97-06 Wrangler | 11603.01 | Each | 11603.04 | Each | 11603.03 | Each | 11603.06 | Each | 11603.05 |
| 87-95 Wrangler** | 11602.01 | Each | 11602.04 | Each | 11602.03 | Each | 11602.06 | Each | 11602.05 |
| 55-86 CJ5/CJ7 | 11601.01 | Each | 11601.02 | Each | 11601.03 | Each | 11601.04 | Each | 11601.05 |
| 81-86 CJ8 Scrambler | 11604.01 | Each | 11601.02 | Each | 11601.03 | Each | 11604.02 | Each | 11604.03 |
| 84-96 Jeep Cherokee | 11605.01 | Each | 11605.02 | Each | 11605.03 | Each | 11605.04 | Each | 11605.05 |

*Except Sahara Models. ** Does not fit YJ Renegade models.

Replacement Fender Flare Hardware & Extensions

| Application | Item/Feature | Part # |
|----------------|--|---------------|
| 87-95 Wrangler | Flare Extension, Driver Side | Each 11602.07 |
| 87-95 Wrangler | Flare Extension, Passenger Side | Each 11602.08 |
| 87-95 Wrangler | Extension retainer | Each 11602.09 |
| 55-86 CJ | Hardware Kit [Extension retainer not included] | 11601.06 |
| 97-06 Wrangler | Flare Extension, Driver Side | Each 11603.07 |
| 97-06 Wrangler | Flare Extension, Passenger Side | Each 11603.08 |
| 97-06 Wrangler | Hardware Kit | 11603.09 |



11602.09 Extension Retainer



11601.06 Hardware Kit Screws Included



11602.07, 11602.08 Flare Extensions



11602.05 Rear Flare, Driver Side, 87-95 Wrangler



11603.07, 11603.08 Flare Extensions

All images are subject to be representative. More detailed information is available online.

WARNING: Read and understand all instructions and related Warnings, Cautions and Notices before attempting to install or use your Rugged Ridge® winch.



ADJUSTABLE TIRE DEFLATOR KIT

Fully inflated tires are great for the road and gas mileage, but they deliver a washboard ride on the trail. Air down your tires for a softer ride and more tread grip. Rugged Ridge® offers two great kits to fit your lifestyle and budget. Made from 100% brass and are fully adjustable in 3 psi. increments. Once you find your desired setting you can lock the deflators where they bleed to the same tire pressure each and every time they are installed. So, you can deflate your tires quickly before heading out on the trail.



NEW!

Rugged Ridge® Adjustable Tire Deflator Kit | Part #
4 Piece Kit **NEW** | 15104.53

KEY CHAIN TIRE DEFLATOR KIT



Fully inflated tires are great for the road and gas mileage, but they deliver a washboard ride on the trail. Air down your tires for a softer ride and more tread grip. The Tire Deflator Kit includes 4 tire deflators that will allow you to easily deflate your tires before heading out on the trail. All pieces connect together onto a key chain for ease.

WINCH COVER

Keep your winch looking as good as the day you bought it with the Rugged Ridge® winch cover. Constructed from durable vinyl lined fabric the cover drops over your winch and secures with a draw cord.







NEW!

Rugged Ridge® Key Chain Tire Deflator Kit | Part #
Key Chain Tire Deflator Kit, 4 Pieces | 15104.50

Winch Cover | Part #
UTV, BIK 2000-4500 **NEW** | 15102.03

ATV/UTV WINCH SPECIFICATIONS- 3 YEAR LIMITED WARRANTY

| | | 2000 | | | | | 2500 | | | | | 3000 | | | | | 3500 | | | | | 4500 | | | | | | | | | | |
|---------------|------|---|-----|------|------|------|---|------|-----|------|------|--|---------------|------|------|------|---|------|---------------|------|------|---|------|------|------|---------------|------|-----|------|------|------|------|
| | |  | | | | |  | | | | |  | | | | |  | | | | |  | | | | | | | | | | |
| | | NEW | | | | | NEW | | | | | NEW | | | | | NEW | | | | | NEW | | | | | | | | | | |
| Part #: | | 15100.50 | | | | | 15100.55 | | | | | 15100.60 | | | | | 15100.65 | | | | | 15100.70 | | | | | | | | | | |
| Pull: | | 2,000lbs. | | | | | 2,500lbs. | | | | | 3,000lbs. | | | | | 4,000lbs. | | | | | 4,500lbs. | | | | | | | | | | |
| Motor: | | 12V - 1.1 HP | | | | | 12V - 1.1 HP | | | | | 12V - 1.3 HP | | | | | 12V - 1.5 HP | | | | | 12V - 2.0 HP | | | | | | | | | | |
| Gear Train: | | Single Stage | | | | | Single Stage | | | | | 3 Stage | | | | | 3 Stage | | | | | 3 Stage | | | | | | | | | | |
| Gear Ratio: | | 153:1 | | | | | 153:1 | | | | | 138:1 | | | | | 198:1 | | | | | 198:1 | | | | | | | | | | |
| Wire Rope: | | 50' x 5/32" | | | | | 50' x 3/16" | | | | | 32' x 7/32" | | | | | 32' x 7/32" | | | | | 32' x 6/25" | | | | | | | | | | |
| Clutch: | | Pull & Turn | | | | | Pull & Turn | | | | | Cam Action | | | | | Cam Action | | | | | Cam Action | | | | | | | | | | |
| Brake: | | Mechanical Gear | | | | | Mechanical Gear | | | | | Automatic in Drum | | | | | Automatic in Drum | | | | | Automatic in Drum | | | | | | | | | | |
| Warranty: | | 3 Year | | | | | 3 Year | | | | | 3 Year | | | | | 3 Year | | | | | 3 Year | | | | | | | | | | |
| Line Pull | LBS | 0 | 500 | 1000 | 1500 | 2000 | Line Pull | LBS | 0 | 1000 | 2000 | 2500 | Line Pull | LBS | 0 | 1000 | 2000 | 3000 | Line Pull | LBS | 0 | 1000 | 2000 | 3000 | 3500 | Line Pull | LBS | 0 | 1000 | 2000 | 3000 | 4500 |
| | KGS | 0 | 227 | 454 | 680 | 907 | | KGS | 0 | 454 | 907 | 1134 | | KGS | 0 | 454 | 907 | 1360 | | KGS | 0 | 454 | 907 | 1360 | 1589 | | KGS | 0 | 454 | 907 | 1360 | 2041 |
| Line Speed | FPM | 10.5 | 9.2 | 7.5 | 5.2 | 2.9 | Line Speed | FPM | 10 | 7.1 | 3.3 | 2.6 | Line Speed | FPM | 24.5 | 14.7 | 10.5 | 6.9 | Line Speed | FPM | 24.5 | 14.7 | 10.5 | 6.9 | 5.9 | Line Speed | FPM | 16 | 10.5 | 9.2 | 7.2 | 4.9 |
| | MPM | 3.2 | 2.8 | 2.3 | 1.6 | 0.9 | | MPM | 3.0 | 2.15 | 1.3 | 0.8 | | MPM | 7.5 | 4.5 | 3.2 | 2.1 | | MPM | 7.5 | 4.5 | 3.2 | 2.1 | 1.8 | | MPM | 4.9 | 3.2 | 2.8 | 2.2 | 1.5 |
| Motor Current | Amps | 12 | 30 | 60 | 75 | 90 | Motor Current | Amps | 12 | 60 | 90 | 120 | Motor Current | Amps | 15 | 75 | 120 | 175 | Motor Current | Amps | 15 | 75 | 120 | 175 | 150 | Motor Current | Amps | 17 | 70 | 105 | 135 | 180 |

Accessories

STANDARD ACCESSORIES INCLUDED WITH ATV/UTV WINCHES



*Handlebar Remote not included with 2,000lb winch.

All images are subject to be representative. More detailed information is available online.



WARNING:

Read and understand all instructions and related Warnings, Cautions and Notices before attempting to install or use your Rugged Ridge® winch.



ATV/UTV Winches

HEAVY DUTY (HD) 2.0 & 2.5 (2,000 & 2,500 LBS) WINCHES

The HD 2.0 & 2.5 come with everything you need to mount your winch and get back out on the trail: Four-way Roller Fairlead, Hand Held Remote, Winch Mounting Plate, Detachable Clevis Hook, 200 Amp Solenoid with wiring harness.

- Durable 12V 1.1 HP Permanent Magnet motor (2.0 Winch)
- Tough Single Stage Planetary Gear box with a 153:1 gear ratio
- Includes heavy duty aircraft grade wire rope with detachable hook
- Mechanical load holding gear brake system
- High Performance 200 Amp Solenoid
- Pull and turn free spooling clutch
- Includes hand held remote
- HD 2.5 Winch includes handle bar remote



HD ATV/UTV Winches

| | Part # |
|---|----------|
| HD 2.0 Winch (2,000 LBS), Each NEW | 15100.50 |
| HD 2.5 Winch (2,500 LBS), Each NEW | 15100.55 |

EXTREME HEAVY DUTY (XHD) 3.0/3.5/4.5 (3,000 LB, 3,500 LBS & 4,000 LB) WINCHES



The Extreme HD 3.0, 3.5, and 4.5 come with everything you need to mount your winch and get back out on the trail: Four-way Roller Fairlead, Hand Held Remote, Handle Bar Remote, Winch Mounting Plate, Detachable Clevis Hook, 200 Amp Solenoid with remote wiring harness.

- Durable 12V 1.3-2.0 HP Permanent Magnet motors
- Tough 3 Stage Planetary Gear box
- Sealed Motor and Gear Box helps keep mud and water out!
- Includes heavy duty aircraft grade wire rope with detachable hook
- Automatic load holding brake system [in the drum brake system]
- High Performance 200 Amp Solenoid
- Cam action free spooling clutch
- Includes hand held and handle bar remotes

Extreme HD ATV/UTV Winches

| | Part # |
|---------------------------------------|----------|
| Extreme HD 3.0 Winch, Each NEW | 15100.60 |
| Extreme HD 3.5 Winch, Each NEW | 15100.65 |
| Extreme HD 4.5 Winch, Each NEW | 15100.70 |



WINCH CABLE STOPPER

Winch Cable Stopper

| | Part # |
|---|----------|
| Red, with Steel Cable or Synthetic Rope, Universal Application NEW | 15102.05 |
| Black, with Steel Cable or Synthetic Rope, Universal Application NEW | 15102.06 |

All images are subject to be representative. More detailed information is available online.

REPLACEMENT SYNTHETIC WINCH ROPES FOR ATV/UTV

Stronger and lighter, the two key elements of Synthetic Rope that make it the choice of competition off road vehicles everywhere. Rugged Ridge® high strength Synthetic Winch Rope is constructed from genuine Dyneema SK-75 fiber imported from the Netherlands. This revolutionary fiber is the choice of off-road enthusiasts worldwide. It is stronger and lighter than wire rope and never kinks or splinters! Our synthetic line is woven from twelve UV-treated strands, resulting in increased strength, and a power to weight ratio unmatched by wire rope. Each synthetic rope comes with a protective sleeve that prevents it from over heating on the winch drum, black powder coated latched hook, stainless steel thimble, and is pre-terminated end for ease of installation. Synthetic rope does not store energy like steel cables, and in the event of a failure it is much less likely result severe injuries caused by the whiplash of broken wire rope. Each replacement rope kits can be easily attached to your current winch by removing your current steel cable and roller fairlead. A new Hawse Fairlead will be required for use with Synthetic Rope.

Synthetic Winch Ropes

| | Part # |
|---|----------|
| Synthetic Winch Rope 3/16" x 50', UTV,ATV, Breaking Force of 4,600 lbs., Each | 15102.30 |
| Synthetic Winch Rope 1/4" x 50', UTV, ATV, Breaking Force of 8,400 lbs., Each | 15102.31 |



ALUMINUM HAWSE FAIRLEAD

This hawse fairlead will help guide the synthetic winch rope to and from the spool. The Rugged Ridge® UTV hawse fairlead features the Rugged Ridge® logo etched into the top to show your loyalty to your favorite brand! Includes hardware.

Aluminum Hawse Fairlead

| | Part # |
|---|----------|
| Aluminum Hawse Fairlead for UTV, Each* NEW | 61238.01 |

* For winch plate PN: 61238.10



RECOVERY GEAR KITS

Includes everything you need to help your buddy next time he gets stuck in the mud. The durable carrying case is filled with our most popular recovery products to make sure you can get out of those trouble spots quickly and safely.

Recovery Gear Kits

| | Part # |
|---|----------|
| The Ultimate ATV / UTV Recovery Gear Kit, Each NEW | 15104.26 |
| The Lite ATV / UTV Recovery Gear Kit, Each NEW | 15104.27 |
| 1" x 15' 10,000lb Recovery Strap NEW | 15104.04 |
| Tree Trunk Protector, 2" x 6' 20,000 lbs, Each NEW | 15104.11 |
| Heavy Duty 8" 8,000 lb Snatch Block Pulley, Each NEW | 11235.12 |



THE LITE KIT

- A. Durable Recovery Gear Bag.
- B. Heavy Duty 8" 20,000lb Snatch Block Pulley.
- C. Premium 1" x 15' 10,000lb Recovery Strap.
- D. Premium 6" x 6' 20,000lb Tree trunk Protector Strap.
- E. One Heavy Duty 6,000lb zinc coated D-Ring.
- F. Tire Repair Kit in soft sided carrying case*.

THE ULTIMATE KIT

- A. Durable Recovery Gear Bag.
- B. Heavy Duty 8" 20,000lb Snatch Block Pulley.
- C. Premium 1" x 15' 10,000lb Recovery Strap.
- D. Premium 6" x 6' 20,000lb Tree trunk Protector Strap.
- E. Pair of Heavy Duty 6,000lb zinc coated D-Rings.
- F. Tire Repair Kit in soft sided carrying case*.
- G. Winch Line Dampener.
- H. Pair of leather Recovery Gloves.

* Tire repair kit contains: [10] Tire Plugs, [1] Aluminum Handle, [1] Reamer Attachment, [1] Needle Attachment, and [1] Allen Wrench.

TRI FOLD RECOVERY SHOVEL, UNIVERSAL APPLICATION

The Rugged Ridge® Tri Fold Recovery Shovel is a fully functional collapsible shovel that features two serrated edges for cutting or digging. The heavy duty black powder coated body is 23 inches when open and folds to a mere 9 inches. It can be stowed easily in any vehicle, but is still rugged enough for the toughest of jobs. Includes durable storage case.



Rugged Ridge® Tri-Fold Recovery Shovel

| | Part # |
|--------------------------------|----------|
| Tri-Fold Recovery Shovel, Each | 15104.42 |



D-RINGS



ATV / UTV Universal D-Rings

| | Part # |
|----------------------------|----------|
| 5/8 Inch, Pair* NEW | 11235.02 |

* Rated for 6,000LBS WLL

WINCH CABLE GRAB HANDLE



Winch Cable Grab Handle

| | Part # |
|--|----------|
| Ultimate Winch Grab Handle Strap, Black, Universal Application, Each | 15102.01 |

All images are subject to be representative. More detailed information is available online.

UTV GRAB HANDLES

63305.05 Dual UTV Grab Strap

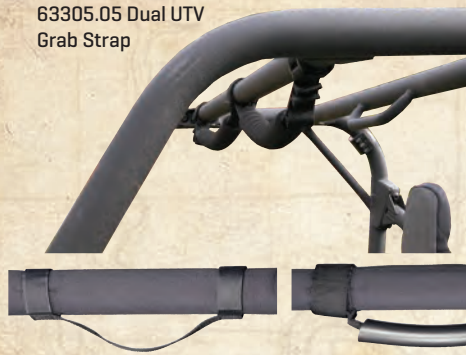

Four styles to choose from: Dual, Ultimate, Deluxe and Sport. Dual, Ultimate and Deluxe models include Sure Grip Handles. The Dual UTV Grab Strap gives passengers a place to hold on while on the trail. Constructed of durable nylon webbing with soft molded foam handles for ease of use and comfort. Easily attaches with hook and loop around the center roll bar, no drilling required. Special side "Pockets" create a handy spot for hanging clothes. Special two handle design gives passengers a place to hang on during those off road adventures. All handles are custom designed to fit UTV Roll bar widths from 1" to 1½".

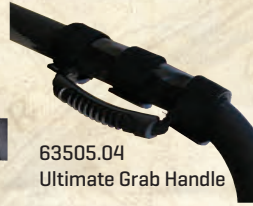

63305.04 Ultimate Grab Handle

63305.01 Sport Grab Handle

63305.02 Deluxe Grab Handle

Grab Handles

Part #

| | |
|--|----------|
| Dual UTV Grab Strap, Black, Each | 63305.05 |
| Ultimate UTV Grab Handles, Black, Pair | 63505.04 |
| Ultimate UTV Grab Handles, Red, Pair | 63505.03 |
| Sport UTV Grab Handles, Black, Pair | 63305.01 |
| Deluxe UTV Grab Handles, Black, Pair | 63305.02 |

NEOPRENE HANDLE KIT



WHEEL SPACERS FOR YAMAHA® RHINO

These spacers space your wheels out an extra 1.75" to help fit wider tires and give your vehicle a wider track and improve stability. Constructed of double anodized black extra thick 6061T6 Aluminum for long life and extra corrosion resistance. All hardware is grade 8 for extra strength.



FIRE EXTINGUISHER HOLDER

Thick nylon web straps are fully adjustable and secure with hook and loop fasteners. Works with both 1" and 1½" roll bars with or without padding. Holds one 3 lb fire extinguisher [not included].



Neoprene Handle Kit

Part #

| | |
|------------------------------------|----------|
| For Yamaha Rhino, Black, 6 pc. Kit | 63305.50 |
| For Yamaha Rhino, Red, 6 pc. Kit | 63305.51 |

Wheel Spacers

Part #

| | |
|--|----------|
| 1.75" Wheel Spacers for Yamaha Rhino, Pair | 65201.05 |
|--|----------|

Fire Extinguisher Holder

Part #

| | |
|---|----------|
| Fits all 1"-1.5" Roll Bars, Black, Each | 63305.21 |
| Fits all 1"-1.5" Roll Bars, Red, Each | 63305.20 |

Accessories

ROLL BAR DRINK HOLDER



Custom designed to place a handy drink holder anywhere along your vertical roll bar. Constructed of durable nylon covered foam with heavy-duty Velcro and nylon straps to secure it to the roll bar. Foam insulates your drink, keeping it cool.

REAR VIEW MIRROR

This rear view mirror clamps to the roll bar of any UTV. Get the same visibility you are used to in your car in an easy to install package.



WINCH PLATE FOR YAMAHA® RHINO

Heavy-duty steel construction, and durable black powder coat finish for longevity. Fits all standard mount UTV winches.



Roll Bar Drink Holder

Part #

| | |
|----------------------------------|----------|
| Fits all 1"-1.5" Roll Bars, Pair | 62101.51 |
|----------------------------------|----------|

Rear View Mirror

Part #

| | |
|----------------------------------|----------|
| Fits all 1"-1.5" Roll Bars, Each | 61020.01 |
|----------------------------------|----------|

Winch Plate

Part #

| | |
|-----------------------------------|----------|
| For Yamaha Rhino, Each NEW | 61238.10 |
|-----------------------------------|----------|

ROLL & PITCH METER

This Roll & Pitch Meter [Clinometer] features two gauges: left displays side to side angle & right displays front to back angle. Each display has a graphic readout that shows angles in degrees for quick reference. The Clinometer attaches to the dash with automotive grade double sided tape or can be permanently mounted with screws.



ROLL BAR STORAGE BAG

This bag allows the storage of all your recovery gear and other important items between the A frame uprights on your Yamaha® Rhino. Constructed of weather resistant material with a zipper flap to help protect your gear from the environment.



Attaches easily with four heavy-duty nylon straps allowing for quick removal and transport using the attached grab handle.

OFF ROAD ORGANIZER

Custom design for use in even the smallest glove boxes. Special pockets allow you to effectively organize manuals, maps, tire gauges, vehicle registration and more. Constructed of durable nylon in a tri-fold configuration.



Roll & Pitch Meter

Part #

| | |
|--|----------|
| Clinometer, UTV Graphic, Compass Model, Each | 63309.01 |
|--|----------|

Roll Bar Storage Bag

Part #

| | |
|------------------------|----------|
| For Yamaha Rhino, Each | 62801.50 |
|------------------------|----------|

Off Road Organizer

Part #

| | |
|--------------------------------|----------|
| Fits all UTV Glove Boxes, Each | 13305.06 |
|--------------------------------|----------|

With over 50 UTV parts available and more on the way, Rugged Ridge® has the trick parts you need to make your UTV truly unique. Whether it's a work vehicle, a hunting rig, or an off road toy, you want to make the most out of your investment - accessorizing with Rugged Ridge® is the way to do it! Whether it's seat covers, grab handles or a full blown cab enclosure, Rugged Ridge® has you covered for all your UTV accessory needs.

63570.01 Nylon Summer Brief, Yamaha Rhino



NYLON/MESH/FABRIC SUMMER BRIEFS FOR YAMAHA® RHINO

Keep the sun off your Rhino's interior while keeping you cool and protected from the elements with a Summer Brief from Rugged Ridge®. Constructed of your choice of nylon, sun stop mesh or durable soft top. All Summer Briefs are custom fit for Yamaha® Rhino and install with nylon web straps with snaps (drilling required). Soft top fabric version is available in Diamond Khaki or Diamond Black for the ultimate look. Sun stop mesh fabric blocks out the heat of the sun while still keeping that open air feel.



63575.01 Mesh Summer Brief
Yamaha Rhino



EXCLUSIVE! Storage Pockets built into each Summer Brief

63701.36 Fabric Summer Brief Yamaha Rhino



| Nylon/Mesh/Fabric Summer Briefs | Part # |
|---|----------|
| Nylon Bikini Top w/Zippered Pockets, Diamond Black, Each | 63570.01 |
| Mesh Bikini Top w/Zippered Pockets, Diamond Black, Each | 63575.01 |
| Fabric Bikini Top w/Zippered Pockets, Diamond Black, Each | 63701.35 |
| Fabric Bikini Top w/Zippered Pockets, Diamond Khaki, Each | 63701.36 |

CAB ENCLOSURE FOR YAMAHA® RHINO



63310.01 Cab Enclosure/
Soft Top, Black Denim
Fabric, for Yamaha Rhino

The Rugged Ridge® Cab Enclosure is a complete soft top that fits over the roll cage to offer protection from the elements. Rugged Ridge® is the premier supplier of soft tops for Jeep® and other off road vehicles. We have used that engineering and research experience to craft the most durable UTV top available. Each Enclosure features the same automotive grade crystal clear DOT approved window glass, welded heat seams, vinyl coated polyester, and cotton fabric we use in our Jeep® tops! Includes zipper storage pockets and zip out windows.

| Cab Enclosure/Soft Top | Part # |
|--|----------|
| Black Denim Fabric, for Yamaha Rhino, Each | 63310.01 |

TONNEAU COVER FOR YAMAHA® RHINO



This durable tonneau cover keeps the contents of your UTV's bed safe from rain, snow, hail and mud. It opens quickly and easily for access to your bed and as a bonus it adds a smooth look to your UTV.

| Tonneau Cover | Part # |
|------------------------|----------|
| For Yamaha Rhino, Each | 63315.01 |

FRONT FENDER GUARDS FOR YAMAHA® RHINO



Heavy-duty 12 gauge steel construction keeps rocks and debris from damaging your plastic inner fenders. Corrosion resistant finish. This is a must buy for anyone who takes their UTV off road!

| Front Fender Guards | Part # |
|------------------------|----------|
| For Yamaha Rhino, Pair | 62004.01 |



Easy to Install!

63210.01 Neoprene Seat Covers w/Headrests

These covers are constructed of durable neoprene or soft poly-cotton front and back for the best looking seat cover available. Rugged Ridge® does not use cheap stretch nylon on their seat covers! Soft poly-cotton protects and prevents the original vinyl seat from getting over heated, no more burned legs! Neoprene (wetsuit material) is a great fabric to protect your seats from dirt, water and whatever mother nature can throw at you. Each cover is custom tailored for your Rhino's original equipment seat style making your seats look like they have been recently reupholstered. Installation is easy with special designed elastic cords, and nylon straps that attach to your seat and to the seat cover mounting points. Available in light gray or black to match the interior of your UTV. Packed in pairs with headrest covers.

| Seat Covers with Headrests | Part # |
|--|----------|
| Neoprene Seat Covers w/Headrest, Black, Pair | 63210.01 |
| Neoprene Seat Covers w/Headrest, Gray, Pair | 63210.09 |
| Fabric Seat Covers w/Headrest, Black, Pair | 63240.01 |
| Fabric Seat Covers w/Headrest, Gray, Pair | 63240.09 |

All images are subject to be representative. More detailed information is available online.

WARNING:

Always secure your load with storage retention devices (not included). Never overload your receiver rack past the limits of 200lbs of evenly spaced cargo.



RECEIVER RACK

- Carry those extra items with ease on the back of your vehicle.
- Mounts to any vehicle with a 2" receiver hitch
- Carries up to 200lbs of evenly distributed cargo.
- Powder coat painted for long life.
- 20"x60" platform.
- Receiver hitch pin not included.

| Receiver Rack | Part # |
|-------------------------|--------|
| All 2" Receiver Hitches | 7700 |



AERODYNAMIC ROOF TOP STORAGE BAG

This storage system is designed for complete weatherproof protection of your cargo. The sloped front deflects water and air up and over the bag. Constructed of durable fiberglass reinforced waterproof tarpaulin material that ensures durability and weather resistance. With over 11 cubic feet of extra storage space this is a perfect alternative for expensive plastic pods. No-drilling required - attaches with heavy duty polypropylene straps to your existing roof rack.

| Roof Top Storage System | Part # |
|-------------------------|----------|
| Aero Storage 11 CuFt. | 12111.01 |



AUTO BACKPACK ROOF TOP STORAGE SYSTEM

This system comes in two different models, depending on your cargo requirements. The outer material is a combination of soft neoprene material to protect your paint and durable nylon for long life. Each Auto Backpack features four tie down points to make installation easy and secure. With 13 or 20 cubic feet of storage space, this is a perfect alternative to those expensive and hard to store plastic pods.

| Roof Top Storage System | Part # |
|-------------------------|----------|
| [39"x32"x18"] 13 CuFt. | 12110.01 |
| [54"x48"x20"] 20 CuFt | 12110.02 |



TAILGATE NETS

- Sport styling improves trucks appearance.
- Improves gas mileage by reducing tail gate drag.
- Constructed of durable die-cut polyester laminate, resists fading and stretching.
- Easy to install - some drilling required.



| Tailgate Nets | Fullsize Trucks | Mid/Small Trucks |
|---------------|-----------------|------------------|
| | 33150.02 | 33150.01 |



UNIVERSAL CHROME TRUCK STEP

- Constructed of highly polished chromed steel.
- One size fits most trucks/SUV's.
- Non-skid tape supplied for added safety.
- Easy to install - some drilling required.
- Sold individually.



| Universal Truck Step | Part # |
|----------------------|----------|
| Chrome | 31501.01 |

CONTRACTORS CONSOLE



- Keeps valuables out of sight while providing a comfortable arm rest and drink holder.
- Arm rest folds forward exposing an oversized 8.5"x11" writing area.
- Reinforced hinge and lid support hold writing surface steady while writing.
- Huge storage compartment is perfect for tools paperwork, cell phones, CD's and cassettes
- Oversized dual adjustable cup holders secure different size cups and bottles.
- Special bottom mount strap allows for center seat belt mounting.
- New removable organizer tray, keeps small items in their place.
- Dimensions - 18.5" Length x 10.5" Width x 8" Height

TRUCK BENCH SEAT CONSOLE



- Large rear storage area has a built-in CD cassette holder.
- Front storage area holds cell phones, glasses, tissues, coins and other small items.
- Can be used for rear seat use to organize clutter and provide hand drink cup holders for passengers.
- Dense foam padded arm rest gives greater comfort and longer life.
- Dimensions - 16.5" Length x 8.5" Width x 9" Height



MINI VAN CONSOLE



- Removable soft sided CD holder keeps CD's clean and organized.
- Front storage compartment holds sunglasses, cell phones, coins, and other small items.
- Cavernous rear storage compartment holds tissue, trash, drinks, and other larger items.
- Dual adjustable front & rear cup holders hold most cups and bottles.
- Constructed of heavy duty padded vinyl to match your interior and provide long life.
- Dense foam arm rest gives greater comfort and is better looking.
- Dimensions - 29" Length x 9" Width x 14" Height.

| Contractors Console | Part # |
|---------------------|----------|
| Charcoal | 33102.09 |
| Tan | 33102.04 |
| Blue | 33102.05 |

| Bench Seat Console | Part # |
|--------------------|----------|
| Charcoal | 33101.09 |
| Tan | 33101.04 |
| Blue | 33101.05 |

| Mini Van Console | Part # |
|------------------|----------|
| Charcoal | 33103.09 |
| Tan | 33103.04 |
| Blue | 33103.05 |

MICKEY THOMPSON BAJA ATZ RADIAL

Mickey Thompson Baja ATZ Radial

| | Part # |
|--|---------|
| Baja ATZ Radial Plus Tire, Blackwall, Mickey Thompson, 35x13.50R20LT NEW | MT-5121 |
| Baja ATZ Radial Plus Tire, Outlined White Letters, Mickey Thompson, 30x9.50R15LT NEW | MT-5150 |
| Baja ATZ Radial Plus Tire, Outlined White Letters, Mickey Thompson, 31x10.50R15LT NEW | MT-5151 |
| Baja ATZ Radial Plus Tire, Outlined White Letters, Mickey Thompson, LT225/75R16 NEW | MT-5160 |
| Baja ATZ Radial Plus Tire, Outlined White Letters, Mickey Thompson, LT245/75R16 NEW | MT-5161 |
| Baja ATZ Radial Tire, Mickey Thompson, Blackwall, LT325/60R18 NEW | MT-5181 |
| Baja ATZ Radial Tire, Mickey Thompson, Blackwall, LT325/65R18 NEW | MT-5183 |
| Baja ATZ Radial Tire, Blackwall, Mickey Thompson, LT305/55R20 NEW | MT-5328 |
| Baja ATZ Radial Tire, Blackwall, Mickey Thompson, 35x12.50R20LT NEW | MT-5329 |
| Baja ATZ Radial Tire, Outlined White Letters, Mickey Thompson, 33x12.50R15LT NEW | MT-5353 |
| Baja ATZ Radial Tire, Blackwall, Mickey Thompson, LT265/75R16 NEW | MT-5362 |
| Baja ATZ Radial Tire, Blackwall, Mickey Thompson, LT285/75R16 NEW | MT-5363 |
| Baja ATZ Radial Tire, Blackwall, Mickey Thompson, LT305/70R16 NEW | MT-5365 |
| Baja ATZ Radial Tire, Outlined White Letters, Mickey Thompson, LT315/75R16 NEW | MT-5366 |
| Baja ATZ Radial Tire, Outlined White Letters, Mickey Thompson, LT265/70R17 NEW | MT-5371 |
| Baja ATZ Radial Tire, Blackwall, Mickey Thompson, LT305/65R17 NEW | MT-5373 |
| Baja ATZ Radial Tire, Blackwall, Mickey Thompson, LT285/70R17 NEW | MT-5374 |
| Baja ATZ Radial Tire, Outlined White Letters, Mickey Thompson, 35x12.50R17 NEW | MT-5375 |
| Baja ATZ Radial Tire, Blackwall, Mickey Thompson, LT305/60R18 NEW | MT-5387 |
| Baja ATZ Radial Tire, Blackwall, Mickey Thompson, LT275/70R18 NEW | MT-5388 |
| Baja ATZ Radial Tire, Blackwall, Mickey Thompson, LT305/70R18 NEW | MT-5389 |

Unique "hybrid" design between an all-terrain and mud terrain with the grip you need for your weekend adventures and the smooth ride you want to get you down the road in comfort. Features an extra wide footprint and beefy tread blocks for great all around traction. Select sizes have PowerPly™ 3-ply sidewalls.



NEW!



MICKEY THOMPSON BAJA MTZ RADIAL

Extreme off-roaders will appreciate the great ride and handling that this mud tire has on the highway. The MTZ has Mickey Thompson's Power Ply™ sidewalls with a special angled third ply to give you high performance handling, better puncture resistance, and improved towing capability.

Mickey Thompson Baja MTZ Radial

| | Part # |
|---|---------|
| Baja MTZ Radial Tire, Blackwall, Mickey Thompson, 35x12.50R20LT NEW | MT-5226 |
| Baja MTZ Radial Tire, Outlined White Letters, Mickey Thompson, 31x10.50R15LT NEW | MT-5251 |
| Baja MTZ Radial Tire, Outlined White Letters, Mickey Thompson, 33x12.5015LT NEW | MT-5253 |
| Baja MTZ Radial Tire, Outlined White Letters, Mickey Thompson, 35x12.50R15LT NEW | MT-5254 |
| Baja MTZ Radial Tire, Outlined White Letters, Mickey Thompson, LT265/75R16 NEW | MT-5262 |
| Baja MTZ Radial Tire, Outlined White Letters, Mickey Thompson, LT285/75R16 NEW | MT-5263 |
| Baja MTZ Radial Tire, Outlined White Letters, Mickey Thompson, LT305/70R16 NEW | MT-5265 |
| Baja MTZ Radial Tire, Outlined White Letters, Mickey Thompson, LT315/75R16 NEW | MT-5266 |
| Baja MTZ Radial Tire, Outlined White Letters, Mickey Thompson, LT265/70R17 NEW | MT-5271 |
| Baja MTZ Radial Tire, Outlined White Letters, Mickey Thompson, LT285/70R17 NEW | MT-5272 |
| Baja MTZ Radial Tire, Outlined White Letters, Mickey Thompson, 33x12.50R17LT NEW | MT-5273 |
| Baja MTZ Radial Tire, Outlined White Letters, Mickey Thompson, LT315/70R17 NEW | MT-5275 |



All images are subject to be representative. More detailed information is available online.



ALL TERRAIN FENDER FLARES

FOR 76-06 JEEP® CJ & WRANGLER

STAINLESS FASTENERS
PROVIDE A GREAT LOOK
AND EASE OF INSTALLATION



CUSTOM DESIGNED FOR
USE WITH THE FACTORY
SIDE MARKER LIGHTS

SPECIAL STYLING
GIVES THESE FLARES
THAT AGGRESSIVE
OFF ROAD LOOK

UV ENHANCED ABS
DESIGN FOR LONG LIFE
AND A GREAT LOOK



AVAILABLE IN 6 PC. KITS FOR:

97-06 WRANGLER/UNLIMITED
87-95 WRANGLER
76-86 CJ-5 / CJ-7 / CJ-8

**Rugged
Ridge** 

Designed by a dedicated team of Jeep® enthusiasts, the ORV™ suspension program is one of the most complete programs available. We have looked at each application in detail to provide the very best and most complete solution for your Jeep®. Since we focus the large majority of our attention on Jeep® vehicles, we know the ins and outs of what the best lift solution is depending on your individual needs. Below is a quick reference guide on the ORV™ program to make it easier to choose the lift you need for your particular need. Remember, all ORV™ Kits with shocks include a pair of neoprene wrapped grab handles and an Off Road Organizer for your glove box! **Welcome to ORV™ by Rugged Ridge®!**



A FEW WORDS ABOUT PRODUCT SAFETY.

Your safety and the safety of other motorists is very important. Your Jeep® is an off road capable vehicle that readily lends itself to restoration and customization. In considering modifications to your Jeep's® suspension you are the person choosing the combination of suspension, wheels, tires, drive train and accessories that best fit your intended use. Likewise, you are the person responsible for the safety and legality of the vehicle you modify. In modifying your vehicle's suspension, balance your desired off road capabilities against how the vehicle may actually be used off road and on road. It is not practical or possible to warn about all hazards associated with your Jeep® or modifying your suspension for improved off road capabilities. Start by familiarizing yourself with all vehicle manufacturers' instructions, warnings limited warranties and the instructions and warnings accompanying your aftermarket product.

To help you make informed decisions about safety; this catalog and the instructions accompanying our products have provided certain information in the form of "Notices" and "Warnings". This information alerts you to potential hazards that could hurt you or others.

NOTICE This is a caution against anything which may cause damage to the vehicle or its equipment if the caution is ignored. The Notice includes information about how you can avoid or reduce those risks.

WARNING This is a signal telling you that you CAN BE KILLED or SERIOUSLY HURT if you don't follow the Warning. The Warning includes information about what you must or must not do in order to reduce the risk of injury to yourself and others.

CAUTION This is a signal telling you that you or others CAN BE HURT if you don't follow the instruction. The Caution includes information about how you can avoid those risks.

WARNING HIGHER ROLLOVER RISK

Modifying the suspension of your vehicle to improve off road capabilities involves certain risks. The modified vehicle may handle differently than as factory equipped including increased ride-height; reduced lateral stability and risk of roll-over or other accident. Also, owner's choice of larger tire and wheel combinations may require additional braking force or increased stopping distances.

- Failure to drive this vehicle safely may result in serious injury or damage. Avoid sharp turns or abrupt maneuvers. Do not drive the vehicle under any speed or maneuvering conditions which may cause the vehicle to trip, roll, lose traction or compromise your ability to safely brake in an emergency.
- Familiarize yourself with all vehicle manufacturers and Rugged Ridge® warnings, instructions and limited warranties before driving this modified suspension vehicle. Follow recommended maintenance procedures and routinely inspect your vehicle components for unusual wear or off road damage.
- Rugged Ridge® does not recommend combined use of body lifts with suspension or other lift devices or modification, alteration or fabrication of any Rugged Ridge® suspension product to achieve additional lift. Also be aware that most states have restrictions on height modifications for vehicles used on road. Consult your vehicle owners manual, limited warranties, the instructions and warnings accompanying this product and state law before undertaking these modifications or using your modified suspension vehicle on road. A summary of current regulations affecting modified suspension vehicles is available from www.SEMA.org.
- Always wear seat belts and/or appropriate off road restraints, reduce your speed, tread lightly® and safely enjoy your off road vehicle.

All images are subject to be representative. More detailed information is available online.

Know your Kits: Though there are many ways to provide extra lift for your Jeep®, ORV™ recommends the following lift options as the best way to Lift your Jeep®:

- Poly Spacer Kits:** Available for Coil Spring Jeep® Wranglers from 97-06 and 99-04 Jeep® Grand Cherokees
- Coil Spring Kits:** Available for Jeep® Wranglers from 97-12, 93-98 Jeep® Grand Cherokees and 84-01 Jeep® Cherokees
- Leaf Spring Kits:** Available for Jeep® CJ/Wrangler from 55-95 and 84-01 Jeep® Cherokees

LIFT OPTIONS EXPLAINED:

- Poly Spacer Kits** - Used for small lifts, these low cost lifts are designed for on road/light off road use only and incorporate the factory coil springs. With the addition of spacers, the ride of your Jeep® will be stiffer than original and provides very little articulation when off road. Bump stops (also called blocks) should always be a part of the kit as you will be using the factory springs. Without the bump stops your spring could over compress or in the case of 07-12 Wranglers, the spring could invert inside itself. These situations can cause a rebound rate that is too great causing a potential mishandling situation or damage your suspension. This method of lifting is the low cost/lower performance solution to lifting your Jeep® vehicle.
- Coil Lift Kits** - Used for medium to large lifts, these lifts are designed for on road and moderate to severe off road use. Coil Spring kits provide the best way to give extra lift and still maintain OE ride characteristics. The 2" - 4" kits should offer new springs and extended bump stops as listed above as well as rear track bar bracket/brace to ensure proper centering of the axle and a secure fit. On 4" kits, it is important have front sway bar disconnects. These important disconnects will provide much more articulation when using your Jeep® off road.
- Leaf Spring Kits** - Used for all Jeep® CJ/Wrangler vehicles from 1955-1995, these heavy-duty lifts provide a fairly straightforward lift option. The key to any leaf spring lift is the leaf spring itself and prices will vary greatly depending on quality and features. Key "must-have" features that will provide the best ride include: 1.) Teflon inserts between each leaf. These inserts allow each leaf to move independently creating a better ride both on and off road. 2.) Leaf springs should be held together with roller clips and not cinch clips. This method of securing the leaf springs together is more expensive but dramatically improves the vehicles ride and off road performance. 3.) Make sure your leaf springs have built-in degree wedges to help with pinion angle issues. Plus by having a degree wedge already attached, installation of the kit will be easier and there are no extra parts to purchase.



18415.33 Poly Spacer Kit



18415.31 Coil Lift Kit



18415.20 Leaf Spring Kit

COIL SPRING KITS



All ORV™ springs are constructed of 5160H hot rolled bar, keeps its memory so the spring will not sag.

All ORV™ springs are set to original factory rates. Provides a better ride both on and off road.

All ORV™ coil springs are powder coated, E-coated 5/8" coil for long life and strength.

All ORV™ leaf springs have built in degree wedges to help correct pinion angle.



All ORV™ leaf springs are pre-assembled and set to factory flex rates.

POLY SPACER KITS



Coil spring spacers are made from high density polyurethane.

All late model CJ/Wrangler ORV™ leaf springs use a roller clip to improve ride.

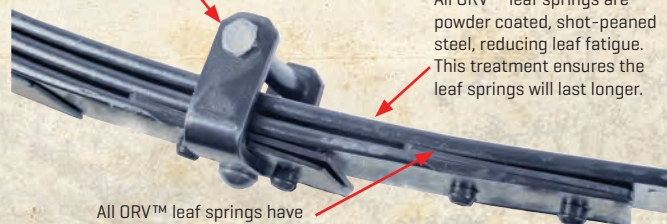

All ORV™ leaf springs have Teflon pads in between each leaf for maximum travel and a better ride.

LEAF SPRING KITS

All ORV™ leaf springs are powder coated, shot-peened steel, reducing leaf fatigue. This treatment ensures the leaf springs will last longer.



Rugged Ridge® bump stops are firmer than stock stops for more suspension control.

ORV™ SHOCKS

ORV™ only uses nitrogen charged gas shocks for all their kits. Though a little more money, the nitro gas shock in combination with the ORV™ kits provide a better ride both on and off road. By using an ORV™ lift kit and matching gas shocks, you optimize the suspension's capabilities giving you a better ride both on and off road. Another advantage to Nitro gas shocks is their ability to prevent body roll. This is extremely important, as body roll will kick in the ESP sensors on later model Jeeps®, which could shut the vehicle down.

ORV™ SHOCK FEATURES INCLUDE:

- 150 PSI pressurized Nitrogen gas
- Internal valving - the internal orifice will rotate when the piston moves more than 2" - automatically adjusts to make the ride as smooth as possible
- Twin tube construction to lower heat build up and protect the shock from off road obstacles
- Constructed to ORV™ specifications by a leading Shock manufacturer
- Bonded Iron 14mm piston with extra chroming - provides for a longer, rust free life
- Includes polyurethane bushings and a black shock boot
- Limited lifetime warranty on the shocks

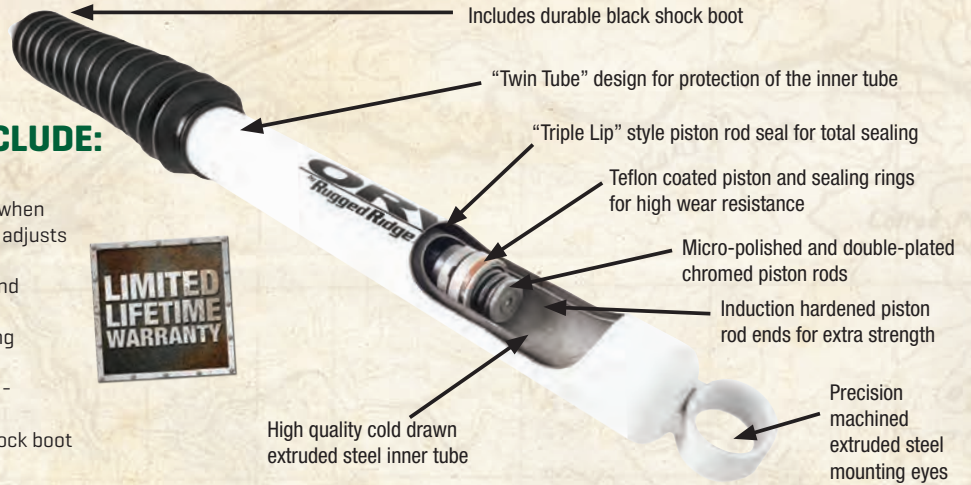

| ORV™ Shocks | Front | Extended | Collapsed | Rear | Extended | Collapsed |
|--|----------|----------|-----------|----------|----------|-----------|
| ORV™ Nitrogen Series Shock, 07-12 Jeep® Wrangler 2-Door, 3.5" Lift, 07-12 Wrangler 4-Door 2.5" Lift | 18465.09 | 22.75" | 13.54" | 18465.10 | 25.35" | 15.05" |
| ORV™ Nitrogen Series Shock, 07-12 Jeep® Wrangler 2-Door, 5" Lift, 07-12 Wrangler 4-Door 4" Lift | 18465.11 | 26.79" | 15.56" | 18465.12 | 28.38" | 16.65" |
| ORV™ Nitrogen Series Shock, 97-06 Jeep® Wrangler, 2" Lift, 04-06 Wrangler Unlimited 2" Lift | 18465.05 | 22.75" | 13.54" | 18465.06 | 22.58" | 13.71" |
| ORV™ Nitrogen Series Shock, 97-06 Jeep® Wrangler, 4" Lift, 04-06 Wrangler Unlimited 4" Lift | 18465.07 | 24.75" | 14.54" | 18465.08 | 24.84" | 14.82" |
| ORV™ Nitrogen Series Shock, 87-95, 07-12 Jeep® Wrangler, 4" Lift | 18465.03 | 28.75" | 16.56" | 18465.04 | 24.84" | 14.82" |
| ORV™ Nitrogen Series Shock, 87-95 Jeep® Wrangler, 2.5" Lift | 18465.09 | 22.75" | 13.54" | 18465.02 | 22.58" | 13.71" |
| ORV™ Nitrogen Series Shock, 76-86 Jeep® CJ, 2" Lift | 18465.14 | 19.07" | 12.07" | 18465.02 | 22.58" | 13.71" |
| ORV™ Nitrogen Series Shock, CJ 76-86 4 Inch Lift Front, ZJ 93-98 3 Inch Lift Rear, 87-95 YJ 2.5 Inch Lift Rear | 18465.02 | 22.58" | 13.71" | 18465.01 | 24.84" | 14.82" |
| ORV™ Nitrogen Series Shock, 55-75 Jeep® CJ, 4" Lift | 18465.01 | 24.84" | 14.82" | 18465.01 | 24.84" | 14.82" |
| ORV™ Nitrogen Series Shock, 84-01 Jeep® Cherokee XJ, 3" Lift | 18465.05 | 22.75" | 13.54" | 18465.06 | 22.58" | 13.71" |
| ORV™ Nitrogen Series Shock, 93-98 Jeep® Grand Cherokee ZJ 3" Lift | 18465.05 | 22.75" | 13.54" | 18465.02 | 22.58" | 13.71" |
| ORV™ Nitrogen Series Shock, 99-04 Jeep® Grand Cherokee WJ 2" Lift | 18465.05 | 22.75" | 13.54" | 18465.13 | 24.84" | 14.82" |
| ORV™ Nitrogen Series Shock, 07-12 Jeep® Wrangler 2-Door 3.5" Lift, 07-12 Jeep® Wrangler 4-Door 2.5" Lift | 18465.15 | 24.75" | 14.54" | 18465.10 | 25.35" | 15.05" |

COLORED SHOCK BOOTS

Add a splash of color to your rig with colored shock boots from Rugged Ridge®. These durable shock boots keep mud and debris from prematurely ruining your shocks and they look great too! Works on ORV™ Nitrogen Shocks and most other brands as well! Sold each.

| ORV™ Shock Boots | Part# |
|--|----------|
| Shock Boot, Black, ORV™ Suspension, Universal Application NEW | 18479.50 |
| Shock Boot, Red, ORV™ Suspension, Universal Application NEW | 18479.51 |
| Shock Boot, Blue, ORV Suspension, Universal Application NEW | 18479.52 |



ORV™ STEERING STABILIZERS

ORV™ recommends upgrading your current steering stabilizer or adding a stabilizer on all lifted Jeep® vehicles. The ORV™ Steering stabilizer dampens out the roughness of the highway and the vibration from running larger tires and wheels. ORV™ Hydraulic Stabilizers also make it easier to move those larger tires and wheels both on and off road. These noticeable handling improvements are well worth the small investment!

| ORV™ Steering Stabilizers | Part# |
|--|----------|
| ORV™ Hydraulic Series Steering Stabilizer, 07-12 Jeep® Wrangler 2 & 4-Door | 18475.03 |
| ORV™ Hydraulic Series Steering Stabilizer, 97-06 Jeep® Wrangler | 18475.02 |
| ORV™ Hydraulic Series Steering Stabilizer, 04-06 Jeep® Wrangler Unlimited | 18475.02 |
| ORV™ Hydraulic Series Steering Stabilizer, 87-95 Jeep® Wrangler | 18475.02 |
| ORV™ Hydraulic Series Steering Stabilizer, 55-86 Jeep® CJ | 18475.01 |
| ORV™ Hydraulic Series Steering Stabilizer, 84-01 Jeep® Cherokee XJ | 18475.02 |
| ORV™ Hydraulic Series Steering Stabilizer, 93-98 Jeep® Grand Cherokee ZJ | 18475.02 |



All images are subject to be representative. More detailed information is available online.

2007-2012 JEEP® WRANGLER



What to Buy:

When looking at which kit is best for your application you need to determine two important things: size of tire and use of vehicle. On the 2007-12 Wrangler JK, 2.5-3.5" coil kit is designed for up to a 34" x 12.5" x 17" tire and moderate off road use. The 4"-5" coil kit is designed for more severe off road use and up to a 35" x 12.5" x 17" tire.

ORV™ 2.5"-3.5" Coil Spring Lift - With shocks part # 18415.50

- The most complete kit available on the market for JK.
 - Includes four powder coated, E-coated 5160H hot rolled bar, 5/8" coil springs that are set to factory rates.
 - By using 5160H hot rolled bar, the ORV Springs keep their memory, eliminating any possibility of future sag.
 - Setting coil springs to factory rates gives you the best on road ride possible and the ability to use a larger tire.
 - Each kit includes a rear track bar brace to strengthen the original track bar mount. An ORV™ exclusive!
 - 4-Door JK's will get on average a 2.5" lift. Two door models will get up to a 3.5" lift. All lifts are dependent on specific Jeep® characteristics and additional parts being put on the vehicle [bumpers, winch, hard tops, soft tops etc.].
- ORV™ kits with shocks include a pair of Neoprene Wrapped Grab Handles and an Off Road Organizer!



JK 2.5"/3.5" Lift Kit

ORV™ 4"-5" Coil Spring Lift - With shocks part # 18415.60

- Get off road performance without sacrificing on road ride.
 - Includes 4 powder coated, E-coated 5160H hot rolled bar 5/8" coil springs, set to factory rates for longer life and better ride!
 - Each kit includes a rear track bar brace to strengthen the original track bar mount. A must for off road performance on a JK.
 - Kit includes sway bar disconnects for more articulation off road.
 - ORV™ uses tough, over built extended control arms for added strength and higher performance. Each arm has a beefy 3/16" wall thickness and each end is tapered before welding. This extra heavy-duty design ensures a long life both on and off road.
 - In most cases control arms are longer than factory to adjust for caster. This is not always true for other brand lifts! Each arm bushing can be easily greased without removing the arm from the vehicle.
 - 4-Door JK's will get on average a 4" lift. Two door models will get up to a 5" lift. All lifts are dependent on specific Jeep® characteristics and additional parts being put on the vehicle [bumpers, winch, hard tops, soft tops etc.].
 - Due to the changed pinion angle, we highly recommend a new drive shaft be installed when using any 4" or greater lift kit on a 4-Door Wrangler. A new drive shaft will be required on any 2007-12 2-Door Wrangler due to the shorter wheel base.
 - All 4" Kits require a drop pitman arm
- ORV™ kits with shocks include a pair of Neoprene Wrapped Grab Handles and an Off Road Organizer!



JK 4"/5" Lift Kit

ORV Suspension

07-12 Jeep® Wrangler JK/Rubicon, 4WD [2 & 4-Door models]

| | Kit w/o Shocks | Kit w/ Shocks | Max Tire Size HxWxD | Max Wheel Offset | Est. Install Time |
|---|----------------|---------------|---------------------|------------------|-------------------|
| 3.5" Lift 07-12 2-Dr, 2.5" 07-12 4-Dr Jeep® Wrangler | 18401.50 | 18415.50 | 34"x12.5"x16" | 4.5" | 6 Hrs. |
| Lift Kit w/out Shocks JK 07-12 2-door 5 inch, JK 07-12 4-Dr 4 Inch* | 18401.60 | 18415.60 | 35"x12.5"x16" | 4.5" | 8 Hrs |

Note: due to vehicle weight, the 2-Door models may receive an additional 1" lift over 4-Door models

* Will require a drop pitman arm. Sold Separately

18401.50 Kit includes: (4) coil springs, rear track bar bracket, rear bump stop bracket, rear track bar brace, hardware kit

18401.60 Kit includes: (4) coil springs, (2) lower front links, (2) lower rear links, (2) rear bump stop brackets, (2) rear bump stop spacers, front track bar bracket, rear track bar bracket, (2) front double disconnect end links, (2) rear extended sway bar end links, rear track bar brace, hardware kit

CAUTION!
CAUTION: Rugged Ridge® recommends use of wheel spacers with all suspension lifts to reduce risk of roll over or other accident associated with modifying ride height for increased off road capabilities. See additional product safety information and WARNINGS at beginning of ORV™ section.

CV EQUIPPED DRIVE SHAFTS FOR 07-12 WRANGLERS

Reduce or eliminate driveline vibration with a CV-equipped driveshaft. Constant Velocity [CV] joints use two U-joints [double cardan style] in the place of a single U-joint. This smooths out the driveline angle and reduces vibration due to extreme lifts or driveline changes. Works with stock to 6" lift.

| CV Equipped Drive Shafts | Part # |
|--------------------------------|----------|
| 07-12 Wrangler, Front 2/4-Door | 16592.22 |
| 07-12 Wrangler, Rear 2-Door | 16592.21 |
| 07-12 Wrangler, Rear 4-Door | 16592.20 |



16592.21 CV Equipped Rear Drive Shaft for 07-12 Wrangler 2-Door

97-2006 JEEP® WRANGLER



What to Buy:

When looking at which kit is best for your application you need to determine two important things: size of tire and use of vehicle. On the 97-06 Wrangler TJ, 2" spacer lifts are designed for a larger tire than factory and light off road use. The 2" coil kit is designed for a larger tire and moderate off road use. The 4" coil kit is designed for more severe off road use and up to a 34" x 12.5" x 15" tire.

ORV™ Coil Spring Lift Kits Feature:

- Get off road performance without sacrificing on road ride! This kit will provide as close to factory a ride as you can get while providing off road articulation.
- Includes four powder coated, E-coated 5160H hot rolled bar, 5/8" coil springs that are set to original factory rates. By using 5160H hot rolled bar, ORV™ springs keep their memory eliminating any possibility of future sag.
- By setting the coil springs to factory rates, you get the best on road ride possible and the ability to use a larger tire.
- ORV™ uses tough, over built extended control arms for added strength and higher performance. Each arm has a beefy 3/16" wall thickness and each end is tapered before welding: this extra heavy-duty design ensures a long life, both on and off road.
- In most cases control arms are longer than factory to adjust for caster. This is not always true for other brand lifts! Each arm bushing can be easily greased without removing the arm from the vehicle.
- Each 2" Coil Spring Lift Kit includes 1" transfer case lowering brackets. These are not spacers but full-length brackets that actually solidly secure your transfer case. ORV™ uses these brackets rather than spacers as spacers can create flex therefore putting undue stress on the drive line.
- Each 4" Coil Spring Lift Kit includes 1.5" transfer case lowering brackets. These are not spacers but full length brackets that actually "true" your transfer case. ORV™ uses these brackets rather than spacers, as spacers can create flex therefore putting undue stress on the drive line.
- Kit includes two sway bar disconnects for more off road articulation.
- Due to the changed pinion angle, we highly recommend a new drive shaft and a slip yoke eliminator kit be installed when using any 4" or greater lift kit on a 1997-2006 Wrangler/Unlimited.
- All 4" Kits will require the purchase of a drop pitman arm to ensure proper steering geometry [sold separately].
- All ORV™ Kits with shocks include a pair of Neoprene Wrapped Grab Handles and an Off Road Organizer for your glove box!



ORV 2" Poly Spacer for 1997-2006 Wrangler 18415.33

- Low cost kit that provides a small lift for over sized tires
- Each kit contains 4 spacers and four bump stops
- Spacers are made of durable polyurethane for a long life

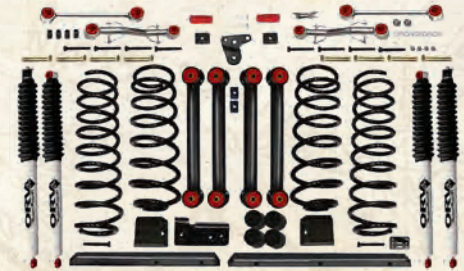

4" Lift for 2003-06 Wrangler/Rubicon 18415.42

| 97-06 Wrangler, 04-06 Wrangler Unlimited | Kit w/o Shocks | Kit w/ Shocks | Max Tire Size HxWxD | Max Wheel Offset | Est. Install Time |
|---|----------------|---------------|---------------------|------------------|-------------------|
| 2" Poly Spacer (4) Lift, 97-06 Wrangler, 99-04 Jeep Cherokees | 18401.33 | 18415.33 | 32"x11.5"x15" | 3.75" | 4 Hrs. |
| 2" Lift, 97-02 Wrangler | 18401.30 | 18415.30 | 32"x11.5"x15" | 3.75" | 6 Hrs. |
| 2" Lift, 03-06 Wrangler/Rubicon | 18401.31 | 18415.31 | 32"x11.5"x15" | 3.75" | 6 Hrs. |
| 2" Lift, 04-06 Wrangler Unlimited/Rubicon | 18401.32 | 18415.32 | 32"x11.5"x15" | 3.75" | 6 Hrs. |
| 4" Lift, 97-02 Wrangler* | 18401.40 | 18415.40 | 34"x12.5"x15" | 3.75" | 6 Hrs. |
| 4" Lift, 03-06 Wrangler/Rubicon* | 18401.41 | 18415.41 | 34"x12.5"x15" | 3.75" | 6 Hrs. |
| 4" Lift, 04-06 Wrangler Unlimited/Rubicon* | 18401.42 | 18415.42 | 34"x12.5"x15" | 3.75" | 6 Hrs. |

* Will require a drop pitman arm. Sold separately.

18401.30 Kit includes: (4) coil springs, (4) lower links, track bar relocation bracket, (3) transfer case lowering brackets, hardware kits

18401.40 Kit includes: (4) coil springs, (4) lower links, track bar relocation bracket, (2) transfer case lowering brackets, (2) transmission lowering brackets, hardware kits

18401.31/.32 Kit includes: (4) coil springs, (4) lower links, track bar relocation bracket, (2) transfer case lowering brackets, (2) transmission lowering brackets, hardware kits

18401.41/.42 Kit includes: (4) coil springs, (2) lower front links, (2) lower rear links, (2) rear bump stop brackets, rear track bar relocation bracket, front double disconnect link, rear sway bar end links, (2) transfer case lowering brackets, (2) transmission lowering brackets, hardware kits.

CV EQUIPPED DRIVE SHAFTS

FOR 87-06 WRANGLERS



16592.05

CV Equipped Drive Shafts

| CV Equipped Drive Shafts | Part # |
|--|----------|
| 87-93 Wrangler with up to 3" Lift | 16592.01 |
| 87-93 Wrangler with over 3" Lift | 16592.02 |
| 94-95 Wrangler with up to 3" Lift ** | 16592.03 |
| 94-95 Wrangler with over to 3" Lift ** | 16592.04 |
| 97-06 Wrangler with 2"-6" Lift | 16592.05 |
| 97-06 Wrangler with 3.5"-6" Lift [for Mega Short SYE only] | 16592.06 |

** These drive shafts use -5/8" wide U-Joints, please verify you U-Joint size before ordering.

TRANSFER CASE SLIP YOKE ELIMINATOR KIT



18676.72

The Mega Short SYE [18676.72] is designed to be used in the same lift applications as the other standard SYE kit [2" and up]. The main advantage to the new Mega Short SYE is that it allows for a much longer drive shaft to be used [additional 3"]. This reduces drive shaft angle, improves bearing & U-joint life, reduces driveline vibrations. It also has a shorter and stronger main shaft design with improved oiling. Will not work with cable driven speedometers. Not for use with Rubicon models.

Transfer Case Slip Yoke Eliminator Kit

| Transfer Case Slip Yoke Eliminator Kit | Part # |
|--|----------|
| 88-06 Wrangler, 88-01 Cherokee Slip Yoke Eliminator [with NP231 transfer case] *, Kit | 18676.60 |
| 88-06 Wrangler, 88-01 Cherokee Mega Short Slip Yoke Eliminator w/ Vehicle Speed Sensor [w/ NP231 transfer case] *, Kit | 18676.72 |
| 88-06 Wrangler, 88-01 Cherokee, Mega Bearing, Slip Yoke Eliminator Service Component | 18676.74 |
| 88-06 Wrangler, 88-01 Cherokee, Output Shaft Oil Seal, Mega Short Slip Yoke Eliminator | 18676.75 |

* A CV Driveshaft is required for this conversion kit

WARNING:

WARNING: OEM slip yokes on 1988-2006 Jeep® Wrangler are not suitable for use with 2" or taller Rugged Ridge™ or other vendors' suspension lifts. Failure of slip yoke may result in damage to transfer case and/or loss of vehicle control. Use of this slip yoke eliminator kit is required for all suspension lifts 2" or taller. See additional product safety information and WARNINGS at back of catalog.

All images are subject to be representative. More detailed information is available online.

1955-95 CJ/WRANGLER

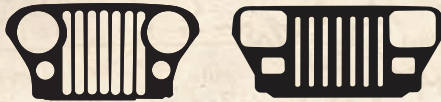

What to Buy:

When looking at which kit is best for your application you need to determine two important things: size of tire and use of vehicle. On the 1976-95 CJ/Wrangler, the 2" - 2.5" Leaf Spring kits are designed for a tire size up to 31" and moderate off road use. The 1955-95 CJ/Wrangler 4" Leaf Spring kits are designed for more severe off road use and up to a 33" x 12.5" x 15" tire.



18415.08

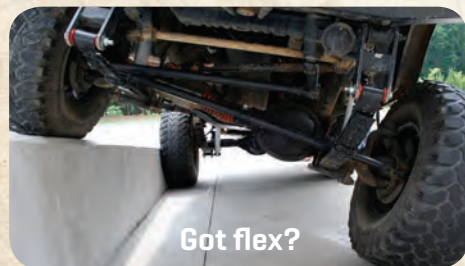

Got flex?

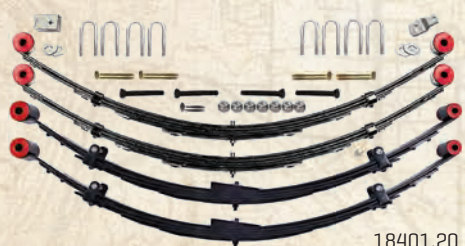

18401.20

18382.01



ORV™ Leaf Spring Lift for 1955-1995 CJ / Wrangler

- Get off road performance without sacrificing on road ride! These kits provide as close to a factory ride as possible.
- Includes 4 powder coated, shot-peened leaf springs with Teflon inserts and pre-installed degree wedges.
- Each leaf spring has Teflon between each leaf for a factory ride, better performance.
- Pre-installed degree wedges provide ease of installation and no more parts to buy. These wedges help to correct any pinion angle issues that may arise due to the lift.
- By shot-peening the leaves before assembly, it assures that the leaf springs will not sag over time.
- All ORV™ U-bolts are grade-8 and E-coated to ensure they will be able to take off road abuse.
- Due to the changed pinion angle, we highly recommend a new drive shaft and a slip yoke eliminator kit be installed when using any 4" or greater lift kit on a 87-95 Wrangler [see below].
- All 4" Kits will require the purchase of a drop pitman arm to ensure proper steering geometry [sold separately, see below].
- Note: Actual lift height is dependent on specific Jeep® characteristics and additional parts being put on the vehicle [bumpers, winch, hard tops, soft tops etc.].
- ORV™ kits with shocks include a pair of Neoprene Wrapped Grab Handles and an Off Road Organizer!

| Application | Kit w/o Shocks | Kit w/ Shocks | Max Tire Size-HxWxD | Max Wheel Offset | Est. Install Time |
|-----------------------------------|----------------|---------------|---------------------|------------------|-------------------|
| 87-95 Wrangler, 2"-2.5" Lift | 18401.20 | 18415.20 | 31"x10.5"x15" | 3.75" | 4 Hrs. |
| 87-95 Wrangler, 4" Lift* | 18401.25 | 18415.25 | 33"x12.5"x15" | 3.75" | 6 Hrs. |
| 76-86 CJ5, CJ7, CJ8, 2"-2.5" Lift | 18401.08 | 18415.08 | 31"x12.5"x15" | 3.75" | 4 Hrs. |
| 76-86 CJ5, CJ7, CJ8, 4" Lift* | 18401.15 | 18415.15 | 33"x12.5"x15" | 3.75" | 4 Hrs. |
| 55-75 CJ5, CJ6, 4" Lift* | 18401.14 | 18415.14 | 33"x12.5"x15" | 3.75" | 4 Hrs. |

* 87-95 Wrangler 4" Lift see SYE kits & CV driveshafts also available.

* 72-76 models will require a drop pitman arm. Sold separately. [See below]

18401.20 Kit includes: [4] leaf springs, [8] U-bolts, hardware kits.

18401.25 Kit includes: [4] leaf springs, [8] U-bolts, hardware kits, [2] track bar extension brackets.

18401.08/.15 Kit includes: [4] leaf springs, [8] U-bolts, hardware kits.

18401.14 Kit includes: [4] leaf springs, [8] U-bolts, hardware kits.

WARNING: WARNING: Look at the beginning of the ORV™ section for important safety information.

| Centering Pin | Part # |
|---|----------|
| Leaf Spring, ORV Suspension, Shaft Diameter: 5/16-in. Length 50mm | 18382.01 |
| Pair, Leaf Spring, ORV Suspension, Shaft Diameter: 5/16-in. Length 50mm | 18382.50 |

ORV Suspension

DROP PITMAN ARMS

Lifting a vehicle takes more than just slapping on taller springs. The stock steering linkage is designed for use with the stock height suspension. The steering linkage angles of a lifted vehicle are more extreme and influenced by suspension travel. This drop pitman arm helps reduce the angle of your drag link and reduce bumpsteer created when a suspension lift is installed.

18006.50



WARNING: WARNING: Look at the beginning of the ORV™ section for important safety information.

| Drop Pitman Arms | Part # |
|--|----------|
| 07-12 Wrangler w/Power Steering, 3.5"-6" of Lift | 18006.55 |
| 87-06 Wrangler w/Power Steering, 4" of Lift | 18006.50 |
| 87-06 Wrangler w/Manual Steering, 4" of Lift | 18006.52 |
| 93-98 Grand Cherokee w/Power Steering, 4"-8" of Lift | 18006.54 |
| 84-01 Cherokee w/Power Steering, 4"-8" of Lift | 18006.54 |
| 76-86 CJ w/Power Steering, 4" of Lift | 18006.51 |
| 76-86 CJ w/Manual Steering, 4" of Lift | 18006.53 |
| 72-75 CJ w/Power Steering, 4" of Lift | 18006.57 |

UNIVERSAL LEAF SPRING PERCH/WELD-ON

- Replacement for collapsed perches
- Allows for relocation of leaf springs or change to wider springs
- Weld-on installation



| Universal Leaf Spring Perch/Weld-On | Tube Radius | Part # |
|-------------------------------------|-------------|----------|
| Universal Spring Perch, Pair | 1.75" Wide | 18267.01 |
| Universal Spring Perch, Pair | 2" Wide | 18267.02 |
| Universal Spring Perch, Pair | 2.5" Wide | 18267.03 |
| Universal Spring Perch, Pair | 3" Wide | 18267.04 |

DEGREE WEDGES

Degree wedges are used to correct pinion angle and reduce driveline vibration on lifted leaf spring equipped vehicles.

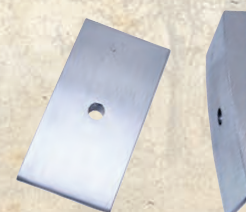

| Degree Wedges, 76-86 CJ, 87-95 YJ | Part # |
|---|----------|
| Cast Aluminum Wedge, Pair [for 6° pinion angle] | 18206.01 |
| Cast Aluminum Wedge, Pair [for 8° pinion angle] | 18206.02 |

1984-01 CHEROKEE

84-01 Jeep Cherokee XJ 3" Lift

- Custom designed add-a-leaf springs with polyurethane bushings for a soft ride & easy installation.
- Tough powder coat finished [E-coated pre finish] U-bolts.
- Kit also includes 2 lower links and front track bar bracket.
ORV™ kits with shocks include an Off Road Organizer!

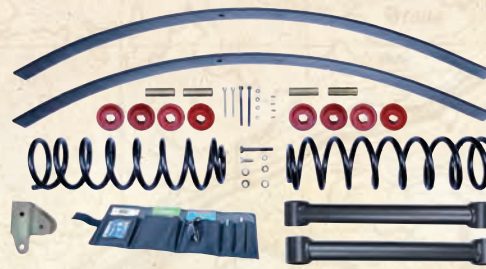

18401.70 Lift Kit, 3" 1984-01 Cherokee



| 84-01 Jeep® Cherokee XJ, 4WD/2WD | Kit w/o Shocks | Kit w/ Shocks | Max Tire Size- HxWxD | Max Wheel Offset | Estimated Install Time |
|--|----------------|---------------|----------------------|------------------|------------------------|
| 3" Lift, 84-01 Jeep® Cherokee, 2WD/4WD** | 18401.70 | 18415.70 | 31"x10.5"x15" | 3.75" | 6 Hours |

**Add-A-Leaf Rear

18401.70 Kit includes: [2] front coil springs, [2] rear add-a-leaf springs

WARNING: WARNING: Look at the beginning of the ORV™ section for important safety information.

1993-98 GRAND CHEROKEE

93-98 Jeep Grand Cherokee 3" Coil Spring Lifts

- Custom designed coil springs for a soft ride, great on road performance.
- Kit includes standard links with urethane bushings for a great ride and long life.
- Also includes front track bar bracket.
- ORV™ kits with shocks include an Off Road Organizer!



18401.75 Lift Kit, 3" 1993-98 Grand Cherokee

| 93-98 Jeep® Grand Cherokee ZJ, 4WD/2WD | Kit w/o Shocks | Kit w/ Shocks | Max Tire Size- HxWxD | Max Wheel Offset | Estimated Install Time |
|--|----------------|---------------|----------------------|------------------|------------------------|
| 3" Lift, 93-98 Jeep® Grand Cherokee, 2WD/4WD | 18401.75 | 18415.75 | 31"x10.5"x15" | 3.75" | 8 Hours |

18401.75 Kit includes: [4] coil springs, [4] lower links, front track bar bracket, hardware kit

WARNING: WARNING: Look at the beginning of the ORV™ section for important safety information.

1999-04 GRAND CHEROKEE

99-04 Jeep Grand Cherokee 2" Poly Spacer Lift

- Custom Spacer kit that gives you a more aggressive look while providing great on road performance.
- Kit includes 4 polyurethane spacers and all necessary installation hardware.
- ORV™ kits with shocks include an Off Road Organizer!
- Bump stops are not required on this kit.



18415.80

| 99-04 Jeep® Grand Cherokee WJ, 4WD/2WD | Kit w/o Shocks | Kit w/ Shocks | Max Tire Size- HxWxD | Max Wheel Offset | Estimated Install Time |
|--|----------------|---------------|----------------------|------------------|------------------------|
| 2" Poly Spacer Lift, 99-04 Jeep® Grand Cherokee, 2WD/4WD | 18401.80 | 18415.80 | 31"x10.5"x16" | 3.75" | 4 Hours |

18401.80 Kit includes: [2] front coil spacers, [2] rear coil spacers

WARNING: WARNING: Look at the beginning of the ORV™ section for important safety information.

HEAVY DUTY SHACKLES

Heavy duty shackles for leaf spring equipped vehicles. Sold in pairs. Available with or without bushings. Wrangler shackles provide 1" of lift. Available with greasable bushings for a quiet ride and easier flexing.

18265.16 Heavy Duty Greasable Shackles, Front, 1987-1995 YJ



| Heavy Duty Shackles | Without Bushings | W/ Black Bushings | With Red Bushings |
|---|------------------|-------------------|-------------------|
| 59-75 CJ, Front Or Rear, Kit | 18265.01 | - | - |
| 59-75 CJ, Greasable Front Or Rear, Kit | 18265.02 | 18265.03 | 18265.04 |
| 76-86 CJ, Front, Kit | 18265.05 | - | - |
| 76-86 CJ, Rear, Kit | 18265.09 | - | - |
| 76-86 CJ, Greasable, Front, Kit | 18265.06 | 18265.07 | 18265.08 |
| 76-86 CJ, Greasable, Rear, Kit | 18265.10 | 18265.11 | 18265.12 |
| 87-95 Wrangler, Front [adds 1" lift], Kit | 18265.13 | - | - |
| 87-95 Wrangler, Rear [adds 1" lift], Kit | 18265.17 | - | - |
| 87-95 Wrangler, Greasable Front [adds 1" lift], Kit | 18265.14 | 18265.15 | 18265.16 |
| 87-95 Wrangler, Greasable Rear [adds 1" lift], Kit | 18265.18 | 18265.19 | 18265.20 |

BODY LIFTS FOR 1997-06 WRANGLER

Need some extra clearance for your oversized tires? This all new Rugged Ridge® body lift includes everything you need to fit up to 33" diameter tires. By allowing a taller tire you'll get that extra ground clearance you need when facing off road obstacles.



18303.11 Body Lift Kit, 1997-06 Wrangler

3" Body Lift

| | Part # |
|---|----------|
| 97-06 Wrangler w/ auto, 05-06 6-speed transmission, Kit | 18303.11 |
| 97-04 Wrangler w/ 5-speed, Kit | 18303.10 |

WARNING
HIGHER ROLLOVER RISK

Rugged Ridge® does not recommend combined use of body lifts with suspension or other lift devices or modification, alteration or fabrication of any Rugged Ridge® product to achieve additional lift. See additional product safety information and WARNINGS in the beginning of the ORV™ section.

All images are subject to be representative. More detailed information is available online.

POLYURETHANE/SUSPENSION ACCESSORIES



1-2003



1-1002

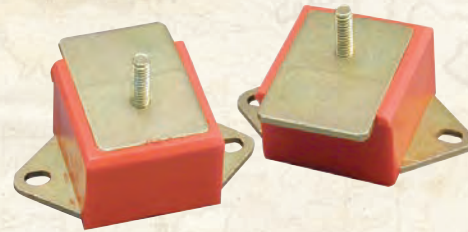

1-501



COMPLETE POLYURETHANE KIT

[includes all major suspension points for steel bodied models.
Not for fiberglass bodies]:

| Description | Poly # | Replaced by Omix # |
|-------------------|--------|--------------------|
| 59-75 CJ | 1-2001 | 18350.01 |
| 76-79 CJ5, CJ7 | 1-2002 | 18350.02 |
| 80-86 CJ5, CJ7 | 1-2003 | 18350.03 |
| 87-95 WRANGLER | 1-2005 | 18350.05 |
| 97-06 WRANGLER | 1-2006 | 18350.06 |
| 84-01 XJ CHEROKEE | 1-2004 | 18350.04 |

FRONT SPRING & SHACKLE BUSHING KITS:

| Description | Poly # | Replaced by Omix # |
|------------------|--------|--------------------|
| 1959-75 CJ | 1-1001 | 18364.01 |
| 1976-86 CJ | 1-1002 | 18364.02 |
| 1987-95 WRANGLER | 1-1005 | 18364.03 |

REAR SPRING & SHACKLE BUSHING KITS:

| Description | Poly # | Replaced by Omix # |
|---------------------|--------|--------------------|
| 1959-75 CJ | 1-1001 | 18364.01 |
| 1976-86 CJ | 1-1003 | 18365.01 |
| 1987-95 WRANGLER | 1-1005 | 18364.03 |
| 1984-01 XJ CHEROKEE | 1-1007 | 18365.02 |



1-1705

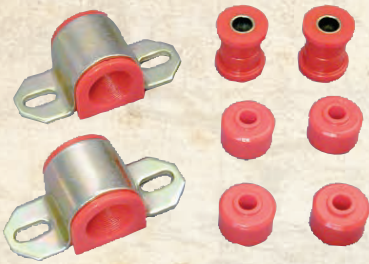

1-1104

SHACKLE BUSHING KITS:

| Description | Poly # | Replaced by Omix # |
|--|--------|--------------------|
| 1959-75 CJ, FRONT OR REAR (NEED 2) | 1-805 | 18366.05 |
| 1976-86 CJ FRONT | 1-801 | 18366.01 |
| 1976-86 CJ REAR | 1-802 | 18366.02 |
| 1987-95 WRANGLER, FRONT OR REAR (NEED 2) | 1-803 | 18366.03 |
| 1984-01 XJ CHEROKEE | 1-804 | 18366.04 |

SWAYBAR BUSHING KITS:

| Description | Poly # | Replaced by Omix # |
|--|--------|--------------------|
| 1976-86 CJ WITH 15/16" DIAMETER BAR, FRONT | 1-1101 | 18367.01 |
| 1976-86 CJ WITH 7/8" DIAMETER BAR, FRONT | 1-1110 | 18367.10 |
| 1987-95 WRANGLER WITH 1 1/8" DIAMETER BAR, FRONT | 1-1107 | 18367.07 |
| 1987-95 WRANGLER WITH 15/16" DIAMETER BAR, FRONT | 1-1102 | 18367.02 |
| 1997-06 WRANGLER WITH 30.5 mm DIAMETER BAR, FRONT | 1-1111 | 18367.11 |
| 1997-06 WRANGLER WITH 13mm DIAMETER BAR, REAR | 1-1112 | 18367.12 |
| 1984-01 XJ CHEROKEE, 1993-98 ZJ GRAND CHEROKEE 24mm, FRONT | 1-1103 | 18367.03 |
| 1984-01 XJ CHEROKEE, 1993-98 ZJ GRAND CHEROKEE 25mm, FRONT | 1-1104 | 18367.04 |
| 1984-01 XJ CHEROKEE, 1993-98 ZJ GRAND CHEROKEE 28mm, FRONT | 1-1105 | 18367.05 |
| 1984-01 XJ CHEROKEE, 1993-98 ZJ GRAND CHEROKEE 23mm, FRONT | 1-1106 | 18367.06 |
| 1984-01 XJ CHEROKEE, 1993-98 ZJ GRAND CHEROKEE 1", FRONT | 1-1108 | 18367.08 |
| 1984-01 XJ CHEROKEE, 1993-98 ZJ GRAND CHEROKEE 7/8", FRONT | 1-1115 | 18367.13 |
| 1984-01 XJ CHEROKEE, 1993-98 ZJ GRAND CHEROKEE 15/16", FRONT | 1-1116 | 18367.14 |
| 1984-01 XJ CHEROKEE, 1993-98 ZJ GRAND CHEROKEE 1-1/8", FRONT | 1-1117 | 18367.15 |
| 1984-01 XJ CHEROKEE, 5/8" BAR, REAR | 1-1118 | 18367.16 |
| 1993-98 ZJ GRAND-CHEROKEE, REAR | 1-1109 | 18367.09 |



1-1701



POLYURETHANE/STAINLESS BRAKE LINES

TRACK ARM BUSHING KITS:

| Description | Poly # | Replaced by Omix # |
|--|--------|--------------------|
| 87-95 WRANGLER, FRONT OR REAR (NEED 2) | 1-1202 | 18368.01 |
| 97-06 WRANGLER, FRONT | 1-1205 | 18368.04 |
| 97-06 WRANGLER, REAR | 1-1206 | 18368.05 |
| 84-01 XJ CHEROKEE, FRONT | 1-1203 | 18368.02 |
| 93-98 ZJ GRAND CHEROKEE, FRONT | 1-1203 | 18368.02 |
| 93-98 ZJ GRAND CHEROKEE, REAR | 1-1204 | 18368.03 |



1-1205

CONTROL ARM BUSHING KITS:

| | | |
|--------------------------------------|-------|----------|
| 97-06 WRANGLER, UPPER & LOWER, FRONT | 1-204 | 18368.03 |
| 84-01 XJ CHEROKEE, FRONT | 1-202 | 18368.01 |
| 93-98 ZJ GRAND CHEROKEE, FRONT | 1-203 | 18368.02 |
| 93-98 ZJ GRAND CHEROKEE, REAR | 1-301 | 18362.04 |



1-1204

COIL SPRING INSULATORS:

| | | |
|----------------------|--------|----------|
| 97-06 WRANGLER, PAIR | 1-1701 | 18369.04 |
|----------------------|--------|----------|

COIL SPRING INSULATOR LIFT:

| | | |
|--|--------|----------|
| 07-12 WRANGLER, 2" LIFT KIT NEW | 1-1708 | 18369.05 |
|--|--------|----------|



1-103

COIL SPRING SPACER:

| | | |
|--|---|----------|
| 97-06 WRANGLER, 2" LIFT, EACH NEW | - | 18369.08 |
|--|---|----------|

BODY MOUNT BUSHING SETS:

| | | |
|-------------------------|-------|----------|
| 55-71 CJ [14 PCS] | 1-101 | 18351.01 |
| 72-75 CJ [18 PCS] | 1-109 | 18351.07 |
| 76-79 CJ5, CJ7 [22 PCS] | 1-102 | 18351.02 |
| 80-86 CJ5, CJ7 [22 PCS] | 1-103 | 18351.03 |
| 81-86 CJ8 [26 PCS] | 1-104 | 18351.04 |
| 87-95 WRANGLER [22 PCS] | 1-105 | 18351.05 |
| 97-06 WRANGLER [22 PCS] | 1-107 | 18351.06 |

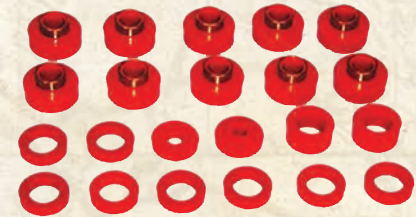

1-1301

1-1901

19-1712

1-501

7-1604

1-1201

MISC. POLYURETHANE ITEMS:

| Description | Poly # | Replaced by Omix # |
|---|----------|--------------------|
| 76-95 CJ & WRANGLER AXLE SNUBBER PAIR | 1-1301 | 18369.03 |
| 76-86 CJ 3.8L & 4.2L 6 CYL COMPLETE DRIVE TRAIN KIT | 1-1901 | 18390.50 |
| 45-95 CJ & WRANGLER, TIE ROD BOOTS | 19-1712 | 18369.02 |
| 72-86 CJ 3.8L & 4.2L 6 CYL ENGINE MOUNT PAIR | 1-501 | 18390.01 |
| 87-06 WRANGLER & XJ CHEROKEE 6-CYL ENGINE MOUNT PAIR | 1-502 | 18390.02 |
| 72-91 V8 AMC ENGINE MOUNT PAIR | 1-503 | 18390.03 |
| 73-95 CJ & WRANGLER TRANS. MOUNT, RED | 7-1604 | 18392.01 |
| 73-95 CJ & WRANGLER TRANS. MOUNT, BLACK | 7-1604BL | 18608.04 |
| 97-06 WRANGLER TRANS. MOUNT | 1-1601 | 18391.01 |
| 72-95 CJ & WRANGLER TRANS. TORQUE ARM BUSHING PAIR | 1-1201 | 18369.01 |
| JACK HANDLE GRABBER [ANTI-RATTLE], ALL HI LIFT STYLE JACKS [NEW] | 19-1404 | 18369.50 |
| 84-01 CHEROKEE, 1997-12 WRANGLER, SWAY BAR DISCONNECT EYE BUSHING NEW | - | 18366.80 |
| SHOCK BUSHING, RUBBER, UNIVERSAL APPLICATION, 1-7/16 LONG, 5/8 ID, 1-IN OD NEW | - | 18367.20 |

FRONT & REAR BRAIDED STAINLESS STEEL BRAKE HOSES:

(PROVIDES UP TO 4" EXTRA LENGTH. ESSENTIAL FOR LIFTED VEHICLES)

| Description | Part # |
|------------------------------------|----------|
| 55-71 CJ W/ DRUM BRAKES FRONT PAIR | 16734.01 |
| 72-73 CJ W/ DRUM BRAKES FRONT PAIR | 16734.02 |
| 74-75 CJ W/ DRUM BRAKES FRONT PAIR | 16734.03 |
| 76-78 CJ W/ DRUM BRAKES FRONT PAIR | 16734.04 |
| 76-81 CJ W/ DISC BRAKES FRONT PAIR | 16734.05 |
| 82-86 CJ W/ DISC BRAKES FRONT PAIR | 16734.06 |
| 87-95 WRANGLER FRONT PAIR | 16734.07 |
| 97-06 WRANGLER FRONT PAIR | 16734.08 |

| Description | Part # |
|----------------------------|----------|
| 55-66 CJ REAR SINGLE | 16735.01 |
| 67-73 CJ SINGLE, REAR | 16735.02 |
| 74-75 CJ SINGLE, REAR | 16735.03 |
| 76-86 CJ SINGLE, REAR | 16735.04 |
| 87-95 WRANGLER REAR SINGLE | 16735.05 |
| 97-06 WRANGLER REAR SINGLE | 16735.06 |

| Description | Part # |
|--|----------|
| 92-01 CHEROKEE 4WD KIT [3-PIECE FRONT & REAR] | 16735.09 |
| 93-98 GRAND CHEROKEE W/ REAR DRUM KIT [3 LINE] | 16735.10 |
| 93-98 GRAND CHEROKEE W/ REAR DISC KIT [5 LINE] | 16735.11 |
| 07-12 WRANGLER KIT [FRONT AND REAR] NEW | 16734.10 |

All images are subject to be representative. More detailed information is available online.

ORV™ SUSPENSION SYSTEMS BY RUGGED RIDGE® LIMITED LIFETIME WARRANTY

Your Omix-Ada® / Rugged Ridge® product is covered by the Lifetime Limited Warranty explained below that gives you specific legal rights. This limited warranty is the only warranty Omix-Ada® / Rugged Ridge® / ORV™ makes in connection with your product purchase. Parts sold by Omix-Ada® or Rugged Ridge® but supplied by other vendors are exclusively warranted by the vendor supplying the part. Omix-Ada® neither assumes nor authorizes any vendor, retailer or other person or entity to assume for it any other obligation or liability in connection with this product or Limited Warranty.

What is covered? Subject to the terms, exclusions and limitations herein and with respect only to products first sold in the United States, Omix-Ada® warrants to the initial retail purchaser only that its Rugged Ridge® suspension kits, and ORV™ shocks and stabilizers shall be free of defects in material and workmanship for so long as the initial retail purchaser owns the vehicle on which these products were originally installed. All other express or implied warranties are hereby disclaimed. Your warrantor for these parts is Omix-Ada®, Inc., 460 Horizon Dr., Suite 400 Suwanee, GA 30024. Omix-Ada® reserves the rights to: [a.] require proof of purchase as a condition of this Limited Warranty, [b.] make future revisions to its Limited Warranty without prior notice.

What is not covered? Your Omix-Ada® / Rugged Ridge® / ORV™ Limited Warranty does not cover any Rugged Ridge® / ORV™ suspension systems that are used or combined with non-ORV™ suspension components. Furthermore, ORV™ suspensions not installed with ORV™ or other recommended shock absorbers may void the Limited Warranty. Products that wear out or fail due to the use of larger tires or wheels are not covered by this Limited Warranty. Your Omix-Ada® Limited Warranty further does not cover products or parts supplied to Omix-Ada® by outside vendors or products, parts or vehicles Omix-Ada® determines to have been damaged by or subjected to:

- Installation damage, alteration, modification or failure to maintain.
- Normal wear and tear [bushings, tie-rod ends, etc.]. Scratches or defects in product finishes [powder coating, plating, etc.] or damage due to shipping.
- Damage arising or related to non- Omix-Ada® / Rugged Ridge® / ORV™, including but not limited to any vehicle's electronic stability system, related components or other vehicle systems.
- Racing or other vehicle competitions or contests. Accidents, impact by rocks, trees, obstacles or other aspects of the environment.
- Theft, vandalism or other intentional damage.
- Products used in application other than those recommended in the current / Rugged Ridge® / ORV™ catalog or the instructions accompanying your Rugged Ridge® /ORV™ product.

Remedy Limited to Repair / Replacement. The exclusive remedy provided hereunder shall, upon Omix-Ada® inspection and at Omix-Ada's® option, be either repair or replacement of product or parts covered under this Limited Warranty. Customers requesting warranty consideration on Omix-Ada® branded parts [including Rugged Ridge® and ORV™] should first contact the independent distributor from whom you purchased your part to obtain a Returned Goods Authorization number. All removal, shipping and installation costs are customer's responsibility. Customers requesting warranty consideration on non-Omix-Ada® branded parts should refer to the manufacturers' Limited Warranty and contact them directly. If a replacement part is needed before the Omix-Ada® part can be returned, you must first purchase the replacement part. Then, if Omix-Ada® deems the part warrantable, you will be credited the purchase price.

Other Limitations - Exclusion of Damages - Your Rights Under State Law

- In consideration of the purchase price paid, neither Omix-Ada® nor any independent Omix-Ada® distributor/licensee are responsible for any time loss, rental costs, or for any incidental, consequential, punitive or other damages you may have or incur in connection with any part or product purchased. Your exclusive remedy hereunder for covered parts is repair/replacement as described above.
- This Limited Warranty gives you specific rights. You may also have other rights that vary from state to state. For example, while all implied warranties are disclaimed herein, any implied warranty required by law is limited to the terms of Limited Warranty described above. Some states do not allow limitations of how long an implied warranty lasts and /or do not allow the exclusion or limitation of incidental or consequential damages, so the limitations and exclusions herein may not apply to you.



DRIVETRAIN ENGINEERING PERFECTED

Are you looking for an axle or ring and pinion rugged enough to match your off the beaten path sense of adventure? Alloy USA® axle shafts and Precision Gear® ring & pinions have been propelling muscle cars, trucks and four wheel drive vehicles down highways, drag strips, back roads and over the world's roughest terrain for nearly a decade. With the recent asset and intellectual property purchase of Alloy USA® and Precision Gear® by Ultra Axle LLC, an affiliate of Omix-Ada® Inc., these two brands are now backed by an industry leading, financially strong company that will be there for you in the long haul. As a member of the Omix-Ada® group of companies Alloy USA® and Precision Gear® will provide the service and support you demand!

The dedicated team of Alloy USA® and Precision Gear® engineers have developed, tested, raced and trail ridden each of our products until they were perfected. We marry the mechanics of engineering with the art of manufacturing to produce the finest in drivetrain solutions. High tensile strength 4340 Chromoly is heat-treated, tempered and induction hardened to produce these heavy-duty axles that are up to 40% stronger than stock. We use the latest splining technology to produce splines that are stronger than traditional cut splines. The shafts are then precision CNC machined and magnaflux inspected for cracks before receiving the Alloy USA® logo and a slick black anodized or natural finish.

Why have we put so much time and energy into developing our Axle Shafts and Ring & Pinions? Because horsepower is useless if you can't get it to the ground. We take pride in engineering solutions and prove it by backing each product with an industry leading warranty. Each axle is covered by our exclusive 10-year limited warranty and each ring and pinion is covered by a 5-year limited warranty so you can drive with confidence!



THE BEST WARRANTY IN THE BUSINESS

Alloy USA®/Precision Gear® Limited Warranty

Your Alloy USA® or Precision Gear® product is covered by the Limited Warranty explained below that gives you specific legal rights. This limited warranty is the only warranty Ultra Axle® LLC [the distributor/warrantor of these products] makes in connection with your purchase. Ultra Axle® LLC neither assumes nor authorizes any vendor, retailer or other person or entity to assume for it any other obligation or liability in connection with its products or Limited Warranty.

What is covered? Subject to the terms, exclusions and limitations herein and with respect only to products first sold in the United States, Ultra Axle® LLC warrants to the initial retail purchaser only that products sold under its Alloy USA® and Precision Gear® trademarks including Axle Shafts, Ring and Pinions, Installation Kits, Jeep® Overhaul Kits, Alloy USA® X Joints and Differential Covers shall be free of defects in material and workmanship for the Limited Warranty term/duration described below. This Limited Warranty shall be measured from the date of initial retail purchase, extends only to the initial retail purchaser and is not transferable. All other express or implied warranties are hereby disclaimed. Your warrantor for these parts is Ultra Axle® LLC, 460 Horizon Dr., Suite 400 Suwanee, GA 30024 [770-614-6101]. Ultra Axle® reserves the right to: [a.] require proof of purchase as a condition of this Limited Warranty, [b.] make future revisions to its Limited Warranty without prior notice.

Duration of Limited Warranty by Product Line

Alloy USA®, front and rear axles- **10 Year Limited Warranty**

Precision Gear® and Alloy USA® Ring and Pinions- **5 Year Limited Warranty**

Jeep® Overhaul kits, Alloy USA® X Joints, Tube Seals, Differential Covers, Differential Cable Lock Kits, Wheel Spacers, Transfer Chain Kits, Yoke Conversion Kits & Hub Conversion Components - **3 Year Limited Warranty**

What is not covered: Your Alloy USA®, Precision Gear® Limited Warranty does not cover damage or claims to any component, vehicle or person other than Alloy USA® or Precision Gear® parts purchased by the initial retail purchaser. Your Alloy USA®, Precision Gear® Limited Warranty does not cover damage or claims to any component, vehicle or person Ultra Axle® LLC determines to have been damaged by or subjected to:

- Installation damage, alteration, modification, misuse or failure to maintain.
- Products used in application other than those recommended in the current Alloy USA®/Precision Gear® catalog or the instructions accompanying your Alloy USA® Precision Gear® product.
- Normal wear and tear/product life deterioration, scratches or defects in product finishes [powder coating, plating, etc.] or damage due to shipping.
- Damage arising or related to non- Ultra Axle® LLC products including but not limited to any vehicle's electronic stability system, related components or other vehicle systems.
- Accidents, impact by rocks, trees, obstacles or other aspects of the use environment.
- Theft, vandalism or other intentional damage.

Remedy Limited to Repair / Replacement. The exclusive remedy provided hereunder shall, upon Ultra Axle® LLC inspection and at Ultra Axle® LLC option, be either repair or replacement of the Ultra Axle® LLC parts covered under this Limited Warranty. Customers requesting warranty consideration should first contact the independent distributor selling your part to obtain a Returned Goods Authorization number. All removal, shipping and installation costs are customer's responsibility. If a replacement part is needed before the Ultra Axle® LLC part can be returned, you must first purchase the replacement part. Then, if Ultra Axle® LLC determines the part warrantable, you will be credited the purchase price of that part.

Other Limitations - Exclusion of Damages - Your Rights Under State Law

- In consideration of the purchase price paid, neither Ultra Axle® LLC nor any independent distributor are responsible for any loss of use or time, rental costs, or for any incidental, consequential, punitive or other damages you may have or incur in connection with your vehicle or any Ultra Axle® LLC product. Your exclusive remedy for Ultra Axle® LLC parts covered hereunder is repair/replacement as described above.
- This Limited Warranty gives you specific rights. You may also have other rights that vary from state to state. For example, while all implied warranties are disclaimed herein, any implied warranty required by law is limited to the duration and other enforceable terms of Limited Warranty described above. Some states do not allow limitations of how long an implied warranty lasts and /or do not allow the exclusion or limitation of incidental or consequential damages, so the limitations and exclusions herein may not apply to you.

© Ultra Axle® LLC Axle LLC. 1.3.2010. All Rights Reserved. Jeep® is a registered trademark of Chrysler LLC. Ultra Axle® LLC is an independent aftermarket vendor not affiliated with any vehicle manufacturer. Pro Gear® and Ultralite Gears and Differentials® are additional trademarks of Ultra Axle® LLC.



Chrysler®, Chevrolet®, Dodge®, GM®, Ford®, Jeep®, International® & other names used here are trademarks of their respective owners and are used within this publication for identification purposes only. Alloy USA® is not affiliated with these companies. The information in this catalog is believed to be correct at the time of publishing. The publisher is not responsible for any losses, direct or indirect, that are the result of any information within this publication. Alloy USA® and Precision Gear® and their corresponding logos are trademarks of Ultra Axle®, LLC. OMIX-ADA® and its corresponding logo are registered trademarks of OMIX-ADA®, Inc.

® Registered 2010, Ultra Axle®, LLC. all rights reserved.

All images are subject to be representative. More detailed information is available online.



FRONT AXLE KITS

High tensile strength 4340 Chromoly is heat-treated, tempered and induction hardened to produce these heavy-duty axles that are up to 40% stronger than stock 1040 axles. Each axle shaft is backed by Alloy USA's exclusive ten-year warranty! We use the latest splining technology to produce splines that are stronger than traditional cut splines. The shafts are then precision CNC machined and magnaflux inspected for cracks before receiving a slick black anodized finish. Our front axle shaft kits include everything you need to complete the job: both passenger and drive side inner and outer axle shafts, seals, U-joints and clips.

JEEP® COMPLETE INNERS/OUTERS WITH U-JOINTS & CLIPS

| Application | Part # | Inner | Outer | Ring |
|---|-----------|-------|-------|------|
| Jeep CJ5 72-83, CJ7 & CJ8 76-81, Dana 30 Grande 30-Spline Kit [Narrow-Trac Kit] ³ | 12129 | 30 | 27 | D30 |
| Jeep CJ5 72-83, CJ7 & CJ8 76-81, Dana 30 Grande 30-Spline Kit With ARB Locker [Narrow-Trac Kit], 3.73 & Up | 12129-ARB | 30 | 27 | D30 |
| Jeep CJ5 72-83, CJ7 & CJ8 76-81, Dana 30 27-Spline Kit [Narrow-Trac Kit] | 12139 | 27 | 27 | D30 |
| Jeep CJ7 & CJ8, 82-86, Dana 30 Grande 30-Spline Kit [Wide-Trac Kit] ³ | 12130 | 30 | 27 | D30 |
| Jeep CJ7 & CJ8, 82-86, Dana 30 Grande 30-Spline Kit With ARB Locker [Wide-Trac Kit], 3.73 & Up | 12130-ARB | 30 | 27 | D30 |
| Jeep CJ7 & CJ8 82-86, Dana 30 27-Spline Kit [Wide-Trac Kit] | 12142 | 27 | 27 | D30 |
| Jeep Wrangler [YJ] 87-95, Cherokee [XJ] 84-91, Dana 30 27-Spline Kit [Disconnect Eliminator] | 12145 | 27 | 27 | D30 |
| Jeep Wrangler [YJ] 87-95, Cherokee [XJ] 84-91, Dana 30 Grande 30/27 Spline Kit | 12131 | 30 | 27 | D30 |
| Jeep Wrangler [YJ] 87-95, Cherokee [XJ] 84-91, Dana 30 Grande 30-Spline Kit w/ARB Locker, 3.73 & Up | 12131-ARB | 30 | 27 | D30 |
| Jeep Wrangler [YJ] 87-95, Cherokee [XJ] 84-91, Dana 30 Grande 30/30-Spline Kit [30-Spline Inners & Outers] | 12231 | 30 | 30 | D30 |
| Jeep Wrangler [YJ] 87-95, Cherokee [XJ] 84-91, Dana 30 Grande 30/30-Spline Kit w/ ARB Locker [30-Spline Inners & Outers] ² , 3.73 & Up | 12231-ARB | 30 | 30 | D30 |
| Jeep Wrangler [TJ] 97-06, Cherokee [XJ] 92-01, Dana 30 27-Spline Kit | 12148 | 27 | 27 | D30 |
| Jeep Wrangler [TJ] 97-06, Cherokee [XJ] 92-01, Dana 30 Grande 30-Spline Kit ³ | 12132 | 30 | 27 | D30 |
| Jeep Wrangler [TJ] 97-06, Cherokee [XJ] 92-01, Dana 30 Grande 30-Spline Kit w/ ARB Locker, 3.73 & Up | 12132-ARB | 30 | 27 | D30 |
| Jeep Wrangler [TJ] 97-06, Cherokee [XJ] 92-01, Dana 30 Grande 30/30-Spline Kit [30-Spline Inners & Outers] ^{1,2,3} | 12232 | 30 | 30 | D30 |
| Jeep Wrangler [TJ] 97-06, Cherokee [XJ] 92-01, Dana 30 Grande 30/30-Spline Kit w/ ARB Locker [30-Spline Inners & Outers] ^{1,2} , 3.73 & Up | 12232-ARB | 30 | 30 | D30 |
| Jeep Wrangler [TJ] Rubicon 03-06, Dana 44 Grande 30-Spline Kit | 12165 | 30 | 27 | D44 |
| Jeep Wrangler [TJ] Rubicon 03-06, Dana 44 30/30-Spline Kit [30-Spline Inners & Outers] ¹ | 12265 | 30 | 30 | D44 |
| Jeep Wrangler [JK] 07-12, Dana 30 27-Spline Kit NEW | 12152 | 27 | 32 | D30 |
| Jeep Wrangler [JK] Rubicon 07-12, Dana 44 30-Spline Kit NEW | 12155 | 30 | 32 | D44 |
| Jeep Wagoneer [SJ] 74-79, Dana 44 30-Spline Kit NEW | 12171 | 30 | 19 | D44 |
| Jeep Wagoneer [SJ] 80-92, Dana 44 30-Spline Kit NEW | 12174 | 30 | 19 | D44 |

¹ NOTE: This kit includes upgraded 30 spline bearing hub units.

² NOTE: When converting to 30 spline outer axles, 1999 and older models must use the 2000-06 Wrangler rotor [Omix 16702.05].

³ NOTE: Upgrade to 30 spline locker required.

GRANDE OUTER STUB UPGRADE

Grande 30 spline outer stub upgrade replaces factory 27 spline outer stub axles to 30 spline.

Kit includes:

- 2 - 30 Spline Chromoly Axle Stub Shafts
- 2 - 30 Spline Unit Bearings
- 2 - Alloy X-Joints



| Application | Part # |
|---|--------|
| Jeep Wrangler [YJ, TJ] 87-06, Cherokee [XJ] 84-01, 30-Spline Outer/Unit Bearing Upgrade Kit | 12168 |
| Jeep Wrangler [TJ] 00-06, 30-Spline Bearing Service Unit. | 35400 |

NOTE: When converting to 30 spline outer axles, 1999 and older models must use the 2000-06 Wrangler brake rotor [Omix 16702.05].

ALLOY USA® DANA 30 MANUAL LOCKING HUB CONVERSION KITS

The Alloy USA® Hub Conversion Kit is designed to upgrade and replace the non-serviceable wheel hubs found on 1984-06 Wrangler and Cherokees. Now you can lock and unlock your front hubs to reduce driveline strain and improve fuel economy! The Deluxe Hub Conversion kit includes a set of Rugged Ridge® Manual Locking Hubs, high tensile strength 27 spline inner and outer Alloy USA® 4340 Chromoly Axle Shafts, 1/2 ton capacity aluminum internal mounting hubs, Alloy USA® X-Joints, machined front brake rotors, bearings, seals and hardware.... everything you need to upgrade your rig and prepare it for the trail. Maximum recommended tire size is 33".

Alloy USA® Grande Hub Conversion Kits Feature:

- Better fuel economy by freewheeling in 2WD mode. Decreases tire wear since unlocked manual hubs rotate more freely.
- Includes beefy corrosion resistant die cast aluminum Rugged Ridge® Manual Locking Hubs.



12198

| Deluxe Hub Conversion with Alloy USA® Inner & Outer Axles | Part # |
|--|----------|
| 87-95 YJ (Eliminates Disonnects), 97-06 TJ, 84-01 XJ, D30 Manual Locking Hub Deluxe Conversion Kit, Includes Alloy USA® Inner Axle Shafts NEW | 12198 |
| Standard Hub Conversion without Inner Shafts | |
| 87-95 Wrangler [YJ], 84-91 Cherokee [XJ], D30 Manual Locking Hub Conversion Kit NEW | 12194 |
| 97-06 Wrangler [TJ], 92-01 Cherokee [XJ], D30 Manual Locking Hub Conversion Kit NEW | 12195 |
| Service Rotor Brake For Front Hub Conversion | |
| 87-95 Wrangler [YJ], 97-06 Wrangler [TJ], 84-01 Cherokee [XJ] NEW | 16702.13 |

FRONT AXLE KITS



| GM Complete Inners/Outers With U-Joints & Clips | Part # | Inner | Outer | Ring |
|---|--------|-------|-------|--------|
| GM 1/2-Ton Pickup, Suburban, Blazer, Jimmy 77-87, 8.5" 30-Spline Kit | 12170 | 30 | 19 | GM 8.5 |
| GM 1/2-Ton Pickup, Suburban, Blazer, Jimmy 73-78, Dana 44 30-Spline Kit | 12172 | 30 | 19 | D44 |
| Ford Complete Inners/Outers With U-Joints & Clips | Part # | Inner | Outer | Ring |
| Ford F150 68-79, Bronco 78-79, Dana 44 30-Spline Kit | 12175 | 30 | 19 | D44 |
| Ford F250 68-79, Dana 44 30-Spline Kit | 12176 | 30 | 19 | D44 |
| Ford Bronco 71-77, Dana 44 30-Spline Kit | 12177 | 30 | 27 | D44 |
| International Complete Inners/Outers With U-Joints & Clips | Part # | Inner | Outer | Ring |
| International Scout 71-80, Dana 44 30-Spline Kit | 12173 | 30 | 27 | D44 |

FRONT & REAR DANA 60 SHAFTS

Our Dana 60 shafts feature the same high strength 4340 Chromoly shafts used in our front axle kits. These heavy-duty shafts are 40% stronger than OE and are made to stand up to abuse. You run a Dana 60 because you wanted the strength, don't let weak 30 spline axles ruin your day. Upgrade to our 35 spline count axles and wheel with confidence. Each Alloy USA® axle is backed by an industry leading 10-year warranty. We use the latest splining technology to produce splines that are stronger than traditional cut splines. Our shafts are heat-treated, tempered and induction hardened to produce these heavy-duty axles that are up to 40% stronger than stock.

| Application | Part # | Side | Length | Spline | Model |
|--|--------|------|--------|--------|-------|
| DODGE | | | | | |
| Dana 60 Chromoly Inner Axle Shaft ⁵ | 10662 | RH | 15.97" | 35 | D60 |
| Dana 60 Chromoly Inner Chevy/Dodge | 10661 | LH | 35.10" | 35 | D60 |
| FORD | | | | | |
| Dana 60 78-79 Ford 18.68 LH Chromoly 35-Spline ⁵ | 10663 | LH | 18.68" | 35 | D60 |
| Dana 60 78-79 Ford 34.56 RH Chromoly 35-Spline ⁵ | 10664 | RH | 34.56" | 35 | D60 |
| Dana 60 Chromoly Inner Axle Shaft, 83-91 Ford, LH, Inner, 35-Spline ⁵ | 10662 | LH | 15.97" | 35 | D60 |
| Dana 60 Ford 83-91 36.68 RH Inner 35-Spline Chromoly ⁵ | 10665 | RH | 36.68" | 35 | D60 |
| FORD OUTER STUB AXLES | | | | | |
| Dana 60 Chromoly Ford Outer Unit Bearing 35-Spline ⁵ | 10652 | NA | 9.39" | 35 | D60 |
| Dana 60 Ford Style Front Outer - 4340 Chromoly ⁵ | 10651 | NA | 11.40" | 35 | D60 |
| GM | | | | | |
| Dana 60 Chromoly RH Inner Axle Shaft Chevy ⁵ | 10660 | RH | 17.67" | 35 | D60 |
| Dana 60 Chromoly LH Inner Chevy/Dodge | 10661 | LH | 35.10" | 35 | D60 |
| GM OUTER STUB AXLES | | | | | |
| Dana 60 GM Style Front Outer - 4340 Chromoly | 10650 | NA | 12" | 35 | D60 |
| BUILDERS SHAFTS | | | | | |
| Dana 60 Front Blank 22" - 4340 Chromoly ⁵ NEW | 10600 | NA | 22" | 35 | D60 |
| Dana 60 Front Blank 39" - 4340 Chromoly ⁵ NEW | 10601 | NA | 39" | 35 | D60 |
| Rear Semi-Float, 35-Spline, Dual Bolt Circle - 4140 Chromoly ⁵ | 21114 | NA | 29.5" | 35 | D60 |
| Rear Semi-Float, 35-Spline, Dual Bolt Circle - 4140 Chromoly ⁵ | 21115 | NA | 29.25" | 35 | D60 |
| Rear Semi-Float, 35-Spline With 3.5"-Spline, Dual Bolt Circle - 4140 Chromoly ⁵ | 21214 | NA | 31.5" | 35 | D60 |
| Rear Semi-Float, 35-Spline With 3.5"-Spline, Dual Bolt Circle - 4140 Chromoly ⁵ | 21215 | NA | 31.25" | 35 | D60 |

⁵ NOTE: Upgrade to a 35 spline locker required

All images are subject to be representative. More detailed information is available online.



PERFORMANCE REAR AXLE KITS FOR JEEP®

High tensile strength 4140 Chromoly is heat-treated, tempered and induction hardened to produce these heavy-duty axles that are up to 35% stronger than stock 1040 axles. Alloy USA® uses the latest cold rolled splining technology, to produce splines that are stronger than traditional cut splines. Our shafts are covered by an exclusive 10-year warranty! Rear axle shaft kits include everything you need for your installation: both passenger and drive side shafts, seals, bearings and wheel studs. Upgraded spline counts for Jeep® applications: Dana 35 spline upgrades from 27 splines to 30 splines. Dana 44 spline upgrades from 30 splines to 33 and 35 splines.



12126

AMC 20 Rear Axle Kit shown includes wheel studs & lug nuts.

Jeep® 2 Axles - Bearings - Seals - Wheel Studs

| | Part # | Spline | Ring |
|---|-----------|--------|------|
| Jeep CJ5 76-83, CJ7 & CJ8 76-81, AMC 20, 1-Piece Conversion, Narrow-Trac, Kit | 12125 | 29 | M20 |
| Jeep CJ7 76-79, AMC 20, 1-Piece Conversion, Quadratrac Kit | 12127 | 29 | M20 |
| Jeep CJ7 & CJ8 82-86, AMC 20, 1-Piece Conversion, Wide-Trac Kit | 12126 | 29 | M20 |
| Jeep Wrangler [YJ] 87-89, Cherokee [XJ] 84-89, Dana 35 Grande 30-Spline Kit, [Non C-clip] ¹ | 12133 | 30 | D35 |
| Jeep Wrangler [YJ] 87-89, Cherokee [XJ] 84-89, Dana 35 Grande 30-Spline Kit With ARB Locker [Non C-clip], 3.54 & Up | 12133-ARB | 30 | D35 |
| Jeep Wrangler [YJ] 87-89, Cherokee [XJ] 84-89, Dana 35 Grande 30-Spline Kit With Detroit Locker [Non C-clip], 3.54 & Up | 12133-DET | 30 | D35 |
| Jeep Wrangler [YJ] 90-95, [TJ] 97-06, Cherokee [XJ] 90-01, Dana 35 27-Spline Kit, [C-clip, Without ABS] | 12200 | 27 | D35 |
| Jeep Wrangler [YJ] 90-95, [TJ] 97-06, Cherokee [XJ] 90-01, Dana 35 Grande 30-Spline Kit, [C-clip, Without ABS] ¹ | 12134 | 30 | D35 |
| Jeep Wrangler [YJ] 90-95, [TJ] 97-06, Cherokee [XJ] 90-01, Dana 35 Grande 30-Spline Kit With ARB Locker, [C-clip, Without ABS], 3.54 & Up | 12134-ARB | 30 | D35 |
| Jeep Wrangler [YJ] 90-95, [TJ] 97-06, Cherokee [XJ] 90-01, Dana 35 Grande 30-Spline Kit With Detroit Locker, [C-clip, Without ABS], 3.54 & Up | 12134-DET | 30 | D35 |
| Jeep Grand Cherokee [ZJ] 94-98, Dana 35 27-Spline Kit NEW | 12201 | 27 | D35 |
| Jeep Grand Cherokee [ZJ] 94-98, Dana 44 30-Spline Kit | 12202 | 30 | D44 |
| Jeep Wrangler [TJ] 97-06, Dana 44 30-Spline Kit | 12135 | 30 | D44 |
| Jeep Wrangler [TJ] 97-06, Dana 44 30-Spline Kit NEW | 12235 | 30 | D44 |
| Jeep Wrangler [TJ] 97-06, Dana 44 Grande 33-Spline Kit ² | 12136 | 33 | D44 |
| Jeep Wrangler [TJ] 97-06, Dana 44 Grande 33-Spline Kit With ARB Locker, 3.92 & Up | 12136-ARB | 33 | D44 |
| Jeep Wrangler [TJ] 97-06, Dana 44 Grande 33-Spline Kit With Detroit Locker, 3.92 & Up | 12136-DET | 33 | D44 |
| Jeep Wrangler [TJ] 97-06, Dana 44 Mas Grande 35-Spline Kit ³ | 12137 | 35 | D44 |
| Jeep Wrangler [TJ] 97-06, Dana 44 Mas Grande 35-Spline Kit With ARB Locker, 3.92 & Up | 12137-ARB | 35 | D44 |
| Jeep Wrangler [JK] 07-12, Dana 44 Grande 30-Spline Kit NEW | 12156 | 30 | D44 |
| Jeep Wrangler [JK] 07-12 Rubicon, Dana 44 Grande 32-Spline Kit NEW | 12158 | 32 | D44 |

¹ NOTE: Upgrade to 30 spline locker required.

² NOTE: Upgrade to 33 spline locker required.

³ NOTE: Upgrade to 35 spline locker required.



PERFORMANCE REAR AXLE SHAFTS

Rule #1: If it broke it needed to be upgraded. For less than the cost of an original replacement axle shaft you can upgrade to an Alloy USA® performance shaft. Each axle is heat-treated, tempered and induction hardened to have twice the tensile strength than stock and is up to 35% stronger. We use the latest splining technology, to produce splines that are stronger than traditional cut splines.

**Jeep® Axle Shafts, Sold Individually.
Wheel Bearings, Seals, & Wheels Studs Available Separately**

| | Part # | Hollander | Spline | Length | Side | Ring |
|---|--------|-----------|--------|----------|-------|-------|
| Jeep CJ5 72-75, Dana 44, LH/RH, 30-Spline | 21147 | NA | 30 | 24-3/4" | LH/RH | D44 |
| Jeep CJ5 76-83, CJ7 & CJ8 76-81, AMC 20, 2-Piece OE Style RH, Narrow-Trac | 21130 | NA | 29 | 29" | RH | M20 |
| Jeep CJ5 76-83, CJ7 & CJ8 76-81, AMC 20, 2-Piece OE Style LH, Narrow-Trac | 21131 | NA | 29 | 26-1/4" | LH | M20 |
| Jeep CJ5 76-83, CJ7 & CJ8 76-81, AMC 20, 1-Piece Conversion RH, Narrow-Trac | 21101 | NA | 29 | 23.06" | RH | M20 |
| Jeep CJ5 76-83, CJ7 & CJ8 76-81, AMC 20, 1-Piece Conversion LH, Narrow-Trac | 21100 | NA | 29 | 26.03" | LH | M20 |
| Jeep CJ7 76-79, AMC 20, 2-Piece OE Style RH, Quadratrac | 21132 | NA | 29 | 22" | RH | M20 |
| Jeep CJ7 76-79, AMC 20, 2-Piece OE Style LH, Quadratrac | 21133 | NA | 29 | 33-1/2" | LH | M20 |
| Jeep CJ7 76-79, AMC 20, 1-Piece Conversion RH, Quadratrac | 21104 | NA | 29 | 19" | RH | M20 |
| Jeep CJ7 76-79, AMC 20, 1-Piece Conversion LH, Quadratrac | 21105 | NA | 29 | 30-7/16" | LH | M20 |
| Jeep CJ7 & CJ8 82-86, AMC 20, 2-Piece OE Style RH, Wide-Trac | 21134 | NA | 29 | 31-9/16" | RH | M20 |
| Jeep CJ7 & CJ8 82-86, AMC 20, 2-Piece OE Style LH, Wide-Trac | 21135 | NA | 29 | 28-9/16" | LH | M20 |
| Jeep CJ7 & CJ8 82-86, AMC 20, 1-Piece Conversion RH, Wide-Trac | 21103 | NA | 29 | 28-7/16" | RH | M20 |
| Jeep CJ7 & CJ8 82-86, AMC 20, 1-Piece Conversion LH, Wide-Trac | 21102 | NA | 29 | 25.19" | LH | M20 |
| Jeep Wrangler [YJ] 87-89, Cherokee [XJ] 84-89, Dana 35, RH, 27-Spline w/o ABS | 21136 | 1799R | 27 | 28.94" | RH | D35 |
| Jeep Wrangler [YJ] 87-89, Cherokee [XJ] 84-89, Dana 35, LH, 27-Spline w/o ABS | 21137 | 1799L | 27 | 30.35" | LH | D35 |
| Jeep Wrangler [YJ] 90-92, Cherokee [XJ] 90-91, Dana 35, RH, 27-Spline w/ ABS NEW | 21138 | NA | 27 | 29.04" | RH | D35 |
| Jeep Wrangler [YJ] 90-92, Cherokee [XJ] 90-91, Dana 35, LH, 27-Spline w/ ABS NEW | 21139 | NA | 27 | 30.54" | LH | D35 |
| Jeep Wrangler [YJ] 90-95, [TJ] 97-06, Cherokee [XJ] 92-01, Dana 35, RH, 27-Spline w/o ABS | 21120 | 1797R | 27 | 29-1/16" | RH | D35 |
| Jeep Wrangler [YJ] 90-95, [TJ] 97-06, Cherokee [XJ] 92-01, Dana 35, LH, 27-Spline w/o ABS | 21121 | 1797L | 27 | 30-9/16" | LH | D35 |
| Jeep Wrangler [YJ] 93-95, [TJ] 97-02, Cherokee [XJ] 92-01 Dana 35, RH, 27-Spline w/ ABS & Drum NEW | 21140 | 1832R | 27 | 29" | RH | D35 |
| Jeep Wrangler [YJ] 93-95, [TJ] 97-02, Cherokee [XJ] 92-01 Dana 35, LH, 27-Spline w/ ABS & Drum NEW | 21141 | 1832L | 27 | 30-5/8" | LH | D35 |
| Jeep Wrangler [TJ] 03-06, Dana 35, RH, 27-Spline w/ABS & Rear Drum NEW | 21148 | NA | 27 | 29" | RH | D35 |
| Jeep Wrangler [TJ] 03-06, Dana 35, LH, 27-Spline w/ABS & Rear Drum NEW | 21149 | NA | 27 | 29.06" | LH | D35 |
| Jeep Wrangler [TJ] 03-06, Dana 35, RH, 27-Spline w/ABS & Rear Disc NEW | 21150 | NA | 27 | 29" | RH | D35 |
| Jeep Wrangler [TJ] 03-06, Dana 35, LH, 27-Spline w/ABS & Rear Disc NEW | 21151 | NA | 27 | 29.75" | LH | D35 |
| Jeep Wrangler [TJ] 97-06, Dana 44, RH, 30-Spline w/o ABS NEW | 21106 | 2416R | 30 | 29-3/4" | RH | D44 |
| Jeep Wrangler [TJ] 97-06, Dana 44, LH, 30-Spline w/o ABS NEW | 21107 | 2416L | 30 | 29-1/4" | LH | D44 |
| Jeep Wrangler [TJ] 03-06, Dana 44, RH, 30-Spline w/ABS & Rear Drum NEW | 21142 | NA | 30 | 29-3/4" | RH | D44 |
| Jeep Wrangler [TJ] 03-06, Dana 44, LH, 30-Spline w/ABS & Rear Drum NEW | 21143 | NA | 30 | 29-1/4" | LH | D44 |
| Jeep Wrangler [TJ] 03-06, Dana 44, RH, 30-Spline w/ABS & Rear Disc NEW | 21144 | NA | 30 | 29-3/8" | RH | D44 |
| Jeep Wrangler [TJ] 03-06, Dana 44, LH, 30-Spline w/ABS & Rear Disc NEW | 21145 | NA | 30 | 30-1/16" | LH | D44 |
| Jeep Wrangler [JK] 07-12, Dana 44, LH/RH, 30-Spline NEW | 21204C | NA | 30 | 31.49" | LH/RH | D44 |
| Jeep Wrangler Rubicon [JK] 07-12, Dana 44, LH NEW | 21205C | NA | 32 | 30.79" | LH | D44 |
| Jeep Wrangler Rubicon [JK] 07-12, Dana 44, RH NEW | 21206C | NA | 32 | 32.165" | RH | D44 |
| Jeep Cherokee [XJ] 91-96, LH/RH, Chrysler 8.25", 27-Spline | 21116 | 1831 | 27 | 29-3/4" | LH/RH | 8.25" |
| Jeep Cherokee [XJ] 97-01, LH/RH, Chrysler 8.25", 29-Spline | 21118 | 2235 | 29 | 29-3/4" | LH/RH | 8.25" |
| Jeep Grand Cherokee [ZJ] 94-98, Dana 35, RH, 27-Spline, w/ ABS & Rear Disc Brakes NEW | 21122 | 2081R | 27 | 29-1/8" | RH | D35 |
| Jeep Grand Cherokee [ZJ] 94-98, Dana 35, LH, 27-Spline, w/ ABS & Rear Disc Brakes NEW | 21123 | 2081L | 27 | 30-9/16" | LH | D35 |
| Jeep Grand Cherokee [ZJ] 94-98, Dana 44, RH, 30-Spline, w/ ABS & Rear Disc Brakes NEW | 21124 | 2232R | 30 | 29-1/4" | RH | D44 |
| Jeep Grand Cherokee [ZJ] 94-98, Dana 44, LH, 30-Spline, w/ ABS & Rear Disc Brakes NEW | 21125 | 2232L | 30 | 30-1/4" | LH | D44 |
| Jeep Grand Cherokee [WJ] 99-04, Dana 35, RH, 27-Spline NEW | 21126 | 2461 | 27 | 30-1/4" | RH | D35 |
| Jeep Grand Cherokee [WJ] 99-04, Dana 35, LH, 27-Spline NEW | 21127 | 2462 | 27 | 31-7/8" | LH | D35 |
| Jeep Grand Cherokee [WJ] 99-04, Dana 44, RH, 30-Spline w/Hydra-Loc NEW | 21128 | 2703R | 30 | 29-3/8" | RH | D44 |
| Jeep Grand Cherokee [WJ] 99-04, Dana 44, LH, 30-Spline w/Hydra-Loc NEW | 21129 | 2703L | 30 | 32-3/8" | LH | D44 |

All images are subject to be representative. More detailed information is available online.

PERFORMANCE REAR AXLE KITS FOR CARS/TRUCKS

Why do you need Alloy USA® axle shafts? Because horsepower is useless if you can't get it to the ground. Our performance rear axle kits feature 1541H alloy steel and have been propelling cars to victory for nearly a decade. 1541H is a high carbon steel that contains significantly more manganese than 1040 steel found in your stock axles. This increases ductility and translates the ability to absorb stresses. Our heat-treated and induction hardened shafts have twice the tensile strength than stock and are up to 35% stronger. We use the latest cold spline rolling technology to produce splines that are stronger than traditional cut splines. No cuts means no edges, which create stress points and can lead to fracturing. The shafts are then precision CNC machined and magnaflux inspected for cracks before receiving a slick black anodized or natural finish. Our rear axle shaft kits include everything you need for your installation: both passenger and drive side shafts, seals, bearings and wheel studs.



Application

| Application | Part # | Spline | Ring |
|--|--------|--------|--------|
| FORD 2 Axles · Bearings · Seals · Wheel studs | | | |
| Ford Mustang 4-Lug 79-93, 8.8", 28-Spline Kit | 12182 | 28 | 8.8" |
| Ford Mustang 4-Lug 79-93, 8.8", 31-Spline Kit ⁴ | 12183 | 31 | 8.8" |
| Ford Mustang 5-Lug 79-93, 8.8", 28-Spline Kit | 12180 | 28 | 8.8" |
| Ford Mustang 5-Lug 79-93, 8.8", 31-Spline Kit ⁴ | 12181 | 31 | 8.8" |
| Ford Mustang 94-98, 8.8", 28-Spline Kit | 12184 | 28 | 8.8" |
| Ford Mustang 94-98, 8.8", 31-Spline Kit ⁴ | 12185 | 31 | 8.8" |
| Ford Mustang 99-04, 8.8", 28-Spline Kit | 12186 | 28 | 8.8" |
| Ford Mustang 99-04, 8.8", 31-Spline Kit ⁴ | 12187 | 31 | 8.8" |
| Ford Mustang 05-12 4.6L, 8.8", 31-Spline Kit NEW | 12189 | 31 | 8.8" |
| GM 2 Axles · Bearings · Seals · Wheel studs | | | |
| Chevrolet Chevelle 65-67, Camaro 67-69, Nova 70-75, 8.2" & 8.5", 28-Spline Kit | 12100 | 28 | 8.2" |
| Chevrolet Chevelle 68-72, Camaro 70-81 LH/RH, 8.2" & 8.5", 28-Spline Kit | 12101 | 28 | 8.2" |
| Chevrolet Chevelle 68-72, Camaro 70-81, 8.875", 30-Spline Kit | 12109 | 30 | 8.875" |
| Chevrolet Chevelle 65-67, Camaro 67-69, 8.875", 30-Spline Kit | 12110 | 30 | 8.875" |
| Chevrolet Chevelle 73-77, 8.5", 28-Spline Kit | 12102 | 28 | 8.5" |
| Chevrolet Camaro 90-92, 7.625", 28-Spline Kit | 12103 | 28 | 7.625" |
| Chevrolet Camaro 93-96, 7.625", 28-Spline Kit | 12104 | 28 | 7.625" |
| INTERNATIONAL HARVESTER 2 Axles · Bearings · Seals · Wheel studs | | | |
| International Harvester Scout 71-80 | 12128 | 30 | D44 |

⁴ NOTE: Upgrade to 31 spline locker required.





PERFORMANCE REAR AXLE SHAFTS FOR CARS/TRUCKS

Axle shafts sold individually. Wheel bearings, seals and wheel studs available separately.

Don't just replace your axle shafts, upgrade them. For less than the cost of an original replacement axle shaft you can upgrade to an Alloy USA® performance shaft. Our axles are made from 1541H or 4140 steel depending on the application. Each axle is heat-treated and induction hardened to have twice the tensile strength than stock and is up to 35% stronger. We use the latest cold spline rolling technology to produce splines that are stronger than traditional cut splines. No cuts means no edges which create stress points and can lead to fracturing. Each shaft is backed by our exclusive 10-year warranty.

| Application | Part # | OE Part # | Hollander | Spline | Length | Side | Ring |
|--|--------|------------|-----------|--------|--------|-----------------------|-----------------|
| FORD Axle Shafts Sold Individually. Wheel bearings, seals and wheel studs available separately. | | | | | | | |
| CAR | | | | | | | |
| Ford Crown Victoria 91-97, Mercury Marquis 92-97 w/ ABS LH/RH NEW | 15159 | F2AZ4234B | 1823 | 1823 | 28 | 31-3/4" | LH/RH 8.8" |
| Ford Crown Victoria 98-02, Mercury Marquis 98-02 LH/RH NEW | 15160 | F8AZ4234B | 2307 | 2307 | 28 | 32-7/16" | LH/RH 7.5"/8.8" |
| Ford Mustang 67-70, Mercury Cougar 67-70 LH 9" 31-Spline NEW | 15150 | C90Z4234C | 973L | 973L | 31 | 27.12" | LH 9" |
| Ford Mustang 67-70, Mercury Cougar 67-70 RH 9" 31-Spline NEW | 15151 | C90Z4234D | 973R | 973R | 31 | 31-1/4" | RH 9" |
| Ford Mustang 4 Lug 79-93 LH/RH, 8.8", 28-Spline | 15116 | D9BZ4234AC | 1231 | 1231 | 28 | 29.125" | LH/RH 8.8" |
| Ford Mustang 79-93 5-lug LH/RH; Ford Ranger 83-92 LH, 8.8" 28-Spline | 15110 | E3TZ4234C | 1338 | 1338 | 28 | 29-1/16" | LH/RH 8.8" |
| Ford Mustang, 4 Lug 79-93 LH/RH, 8.8-Inch, 31-Spline NEW ^a | 15142 | M-4235-B | - | - | 31 | 29-1/16" | LH/RH 8.8" |
| Ford Mustang, 5 Lug 79-93 LH/RH, 8.8-Inch, 31-Spline NEW ^a | 15138 | M-4235-F | - | - | 31 | 29-1/16" | LH/RH 8.8" |
| Ford Mustang 94-98 LH/RH, 8.8", 28-Spline | 15117 | F4ZZ4234B | 2006 | 2006 | 28 | 29-15/16" | LH/RH 8.8" |
| Ford Mustang, 94-98 LH/RH, 8.8-Inch, 31-Spline NEW ^a | 15137 | M-4235-D | - | - | 31 | 29-15/16" | LH/RH 8.8" |
| Ford Mustang 99-04 LH/RH, 8.8", 28-Spline | 15154 | XR3Z4234AA | 2425 | 2425 | 28 | 30-5/8" | LH/RH 8.8" |
| Ford Mustang, 99-04 LH/RH, 8.8-Inch, 31-Spline NEW ^a | 15136 | M-4235-E | - | - | 31 | 30-5/8" | LH/RH 8.8" |
| Ford Mustang 05-12 4.6L LH, 8.8", 31-Spline NEW | 15156 | 5R3Z4234B | - | - | 31 | 31-11/16" | LH 8.8" |
| Ford Mustang 05-12 4.6L RH, 8.8", 31-Spline NEW | 15155 | 5R3Z4234A | - | - | 31 | 32-13/16" | RH 8.8" |
| TRUCK | | | | | | | |
| Ford Bronco II, 83-91 RH, 8.8", 28-Spline NEW | 15109 | E4T423A | 1227 | 1227 | 28 | 27-3/4" | RH 8.8" |
| Ford Aerostar, 86-97 LH, 7.5", 28-Spline | 15111 | E69Z4234A | 1456 | 1456 | 28 | 32-1/4" | LH 7.5"/8.8" |
| Ford Expedition, Lincoln Navigator 97-02 RH, 9.75", 34-Spline | 15146 | F75Z4234LA | 2236 | 2236 | 34 | 31-1/4" | RH 9.75" |
| Ford Expedition, Lincoln Navigator 97-02 LH, 9.75", 34-Spline | 15145 | F75Z4234LB | 2237 | 2237 | 34 | 33.37" | LH 9.75" |
| Ford Explorer 95-00 RH, 8.8" 31-Spline | 15114 | F5TZ4234A | 2120 | 2120 | 31 | 27.62" | RH 8.8" |
| Ford Explorer 95-00 LH, 8.8" 31-Spline | 15115 | F5TZ4234B | 2121 | 2121 | 31 | 30-1/2" | LH 8.8" |
| Ford E150 87-96 RH, 8.8", 31-Spline | 15107 | E7UZ4234E | 1575 | 1575 | 31 | 35-5/8" | RH 8.8" |
| Ford F150, E150 74-86, Rear LH/RH, 9", 31-Spline | 15102 | D6TZ4234A | 1172 | 1172 | 31 | 31-27/32" | LH/RH 9" |
| Ford F150, Bronco 83-86 RH, 8.8", 31-Spline | 15100 | E3TZ4264D | 1340 | 1340 | 31 | 31-1/16" ¹ | RH 8.8" |
| Ford F150, Bronco 83-86 LH, 8.8", 31-Spline | 15101 | E3TZ4234E | 1341 | 1341 | 31 | 31-3/16" | LH 8.8" |
| Ford F150, E150, Bronco 87-96 RH, 8.8", 31-Spline | 15103 | E7TZ4234A | 1573 | 1573 | 31 | 31-1/16" | RH 8.8" |
| Ford F150, Bronco 87-96 LH, 8.8", 31-Spline | 15104 | E7TZ4234B | 1574 | 1574 | 31 | 33-3/16" | LH 8.8" |
| Ford F150, Expedition 97-04, RH, 8.8", 31-Spline | 15105 | F75Z4234AA | 2192 | 2192 | 31 | 31-3/4" | RH 8.8" |
| Ford F150, Expedition 97-04, LH, 8.8", 31-Spline | 15106 | F75Z4234AB | 2193 | 2193 | 31 | 33-3/8" | LH 8.8" |
| Ford F150, 97-04 LH, 9.75", 34-Spline | 15143 | F75Z4234MB | 2239 | 2239 | 34 | 33.37" | LH 9.75" |
| Ford F150, 97-04 RH, 9.75", 34-Spline | 15144 | F75Z4234MA | 2238 | 2238 | 34 | 31-3/4" | RH 9.75" |
| Ford F250, 86-97 RH Semi Float, 10.25", 35-Spline | 15134 | E6TZ4234B | 1506 | 1506 | 35 | 30.56" | RH 10.25" |
| Ford F250, 86-97 LH Semi Float, 10.25", 35-Spline | 15135 | E6TZ4234C | 1507 | 1507 | 35 | 33" | LH 10.25" |
| Ford Ranger 83-92 RH, 7.5", 28-Spline | 15108 | E3TZ4234B | 1337 | 1337 | 28 | 26-1/4" | RH 7.5"/8.8" |
| Ford Ranger 93-97 RH, 8.8", 28-Spline | 15139 | F37Z4234A | 2080R | 2080R | 28 | 27-1/4" | RH 8.8" |
| Ford Ranger 93-97 LH, 8.8", 28-Spline NEW | 15140 | F37Z4234B | 2089L | 2089L | 28 | 30-1/8" | LH 10.75"/8.8" |
| Ford Ranger 99-01 RH, 7.5" / 8.8", 28-Spline | 15157 | F87Z4234AC | 24A | 24A | 28 | 27-1/4" | RH 7.5"/8.8" |
| Ford Ranger 99-01 LH, 7.5" / 8.8", 28-Spline | 15158 | F87Z4234AD | 2420 | 2420 | 28 | 30-1/4" | LH 7.5"/8.8" |

^a NOTE: Upgrade to 31 spline locker required.

All images are subject to be representative. More detailed information is available online.

PERFORMANCE REAR AXLE SHAFTS FOR CARS/TRUCKS CONTINUED



Induction Hardened &
Heat Treated

Cold Rolled Splines

Black Anodized or
Natural Finish

Up to 35% Stronger Than Stock



Application

DODGE Axle Shafts Sold Individually. Wheel bearings, seals and wheel studs available separately.

Dodge Truck/Ramcharger 4WD 74-79, Truck/Ramcharger 2WD 75-83 LH/RH, 9.25", 31-Spline

| Part # | OR Part # | Hollander | Spline | Length | Side | Ring |
|---|-----------|-----------|--------|-----------|-------|----------|
| 19100 | 3723824 | 1081 | 31 | 31-1/16" | LH/RH | 9.25" |
| 19102 | 4037726 | 1289 | 31 | 31-5/8" | LH/RH | 9.25" |
| 19101 | 4137429 | 1398 | 31 | 31-5/8" | LH/RH | 9.25" |
| 19111 | 52067614 | 2030 | 31 | 34" | LH/RH | 9.25" |
| GM Axle Shafts Sold Individually. Wheel bearings, seals and wheel studs available separately. | | | | | | |
| 17131 | - | - | 28 | 30" | LH/RH | 8.2" |
| 17119 | 3969285 | 1000 | 30 | 30-1/16" | LH/RH | 8.875" |
| 17120 | 3969349 | 1005 | 30 | 29-9/16" | LH/RH | 8.875" |
| 17121 | 1255803 | 1010 | 28 | 29-5/8" | LH/RH | 8.2/8.5" |
| 17122 | 1255802 | 1015 | 28 | 30-1/8" | LH/RH | 8.2/8.5" |
| 17123 | 1255801 | 1067 | 28 | 29-9/16" | LH/RH | 8.5" |
| 17126 | 26031252 | 1776 | 28 | 30-5/8" | LH/RH | 7.625" |
| 17127 | 26027558 | 1960 | 28 | 32" | LH/RH | 7.6" |
| 17136 | 26059972 | 2342 | 28 | 32" | LH/RH | 7.625" |
| 17141 | 26018080 | 1858 | 30 | 30-3/8" | LH/RH | 8.5" |
| 17133 | 3893605 | 780 | 30 | 20-1/2" | LH/RH | 8.875" |
| 17103 | 14071750 | 1063 | 30 | 31-9/32" | LH/RH | 8.875" |
| 17109 | 14071751 | 1062 | 30 | 31-5/16" | LH/RH | 8.875" |
| 17112 | 14035542 | 1204 | 28 | 31.38" | LH/RH | 8.5" |
| 17104 | 14039547 | 1300 | 28 | 31-5/16" | LH/RH | 8.5" |
| 17140 | 14035395 | 1276 | 33 | 32-9/16" | LH/RH | 9.5" |
| 17137 | 26010416 | 1671 | 30 | 33" | LH/RH | 8.5" |
| 17105 | 26010414 | 1652 | 30 | 31-5/16" | LH/RH | 8.5" |
| 17106 | 15521928 | 1610 | 33 | 33.13" | LH/RH | 9.5" |
| 17113 | 26010415 | 1669 | 30 | 31-3/4" | LH/RH | 8.5" |
| 17110 | 26010417 | 1670 | 30 | 31-13/16" | LH/RH | 8.5" |
| 17118 | 15522070 | 1615 | 33 | 31-13/16" | LH/RH | 9.5" |
| 17129 | 12471369 | 2457 | 30 | 33-5/8" | LH/RH | 8.5" |
| 17108 | 14035368 | 1329 | 26 | 29" | LH/RH | 7.6" |
| 17125 | 26015759 | 1599 | 28 | 26-5/8" | LH/RH | 7.5" |
| 17107 | 26013882 | 1651 | 28 | 29" | LH/RH | 7.5" |
| 17139 | 14042690 | 1085 | 28 | 33-5/16" | LH/RH | 8.5" |
| 17138 | 26013313 | 1672 | 30 | 33-5/16" | LH/RH | 8.5" |
| 17116 | 26011054 | 1765 | 28 | 34-13/16" | LH | 7.5" |
| 17117 | 26011055 | 1764 | 28 | 30-1/16" | RH | 7.5" |
| INTERNATIONAL Axle Shafts Sold Individually. Wheel bearings, seals and wheel studs available separately. | | | | | | |
| 21117C | 706162-2X | - | 30 | 28-1/4" | LH/RH | D44 |

JEEP® RING & PINIONS

These affordable high strength gear sets come in all the popular ratios to satisfy everyone's gearing needs. Oversized tires require higher ring & pinion ratios to restore performance. Made from high quality 8620 forgings and Gleason gear cutting technology, these gears are made to last. Complete installation kits are available separately to complete the job. Exclusive 5-year warranty. Available in 3.55, 3.73, 4.10, 4.56, 4.88, 5.13 and 5.38 ratios.



| Application | Ratio | Part # |
|--|-------|-----------|
| FRONT | | |
| CJ5, CJ7, CJ8, 72-86, Dana 30 Front, 3.73 Ratio | 3.73 | 030373 |
| CJ5, CJ7, CJ8, 72-86, Dana 30 Front, 4.10 Ratio | 4.10 | 030410 |
| CJ5, CJ7, CJ8, 72-86, Dana Front 30, 4.56 Ratio | 4.56 | 030456 |
| CJ5, CJ7, CJ8, 72-86, Dana 30 Front 4.88 Ratio | 4.88 | 030488 |
| Wrangler [YJ] 87-95, Cherokee [XJ] 84-91, Dana 30 Reverse, 3.73 Ratio | 3.73 | 030373R |
| Wrangler [YJ] 87-95 Cherokee [XJ] 84-91, Dana 30 Reverse, 4.10 Ratio | 4.10 | 030410R |
| Wrangler [YJ] 87-95, Cherokee [XJ] 84-91, Dana 30 Reverse, 4.56 Ratio | 4.56 | 030456R |
| Wrangler [YJ] 87-95, Cherokee [XJ] 84-91, Dana 30 Reverse, 4.88 Ratio | 4.88 | 030488R |
| Wrangler [TJ] 97-06, Front Dana 30, 3.73 Ratio [Short] | 3.73 | 030373TJ |
| Wrangler [TJ] 97-06 Front Dana 30, 4.10 Ratio [Short] | 4.10 | 030410TJ |
| Wrangler [TJ] 97-06, Cherokee [XJ] 92-01, Dana 30, 4.56 Ratio [Short] | 4.56 | 030456TJ |
| Wrangler [TJ] 97-06, Cherokee [XJ] 92-01, Dana 30 4.88 Ratio [Short] | 4.88 | 030488TJ |
| Wrangler [TJ] Rubicon 03-06, Front/Rear Dana 44, 4.88 Ratio | 4.88 | 044488X |
| Wrangler [TJ] Rubicon 03-06, Front/Rear Dana 44, 5.13 Ratio | 5.13 | 044513X |
| Wrangler [JK] 07-12, Liberty [KK] 08-09 Front Dana 30, 3.73 Ratio NEW* | 3.73 | 030373RJK |
| Wrangler [JK] 07-12, Front Dana 30, 4.10, Ratio NEW* | 4.10 | 030410RJK |
| Wrangler [JK] 07-12, Front Dana 30, 4.88 Ratio NEW* | 4.88 | 030488RJK |
| Wrangler [JK] 07-12, Front Dana 30, 5.13 Ratio NEW* | 5.13 | 030513RJK |
| Wrangler [JK] 07 (w/ Trulock) 08-12 All, Front Dana 44, 4.10 Ratio NEW* | 4.10 | 044410RJK |
| Wrangler [JK] 07-12, Front Dana 44, 4.88 Ratio NEW* | 4.88 | 044488RJK |
| Wrangler [JK] 07-12, Front Dana 44, 5.13 Ratio NEW* | 5.13 | 044513RJK |
| Wrangler [JK] 07-12, Front Dana 44, 5.38 Ratio NEW* | 5.38 | 044538RJK |
| REAR | | |
| CJ5, CJ7, CJ8, 76-86, AMC 20, 3.73 Ratio | 3.73 | AMC373 |
| CJ5, CJ7, CJ8, 76-86, AMC 20, 4.10 Ratio | 4.10 | AMC410 |
| CJ5, CJ7, CJ8, 76-86, AMC 20, 4.56 Ratio | 4.56 | AMC456 |
| CJ5, CJ7, CJ8, 76-86, AMC 20, 4.88 Ratio | 4.88 | AMC488 |
| Wrangler [YJ, TJ] 87-06, Cherokee [XJ] 84-01, Dana 35 Rear, 3.73 Ratio | 3.73 | 035373 |
| Wrangler [YJ, TJ] 87-06, Cherokee [XJ] 84-01, Dana 35 Rear, 4.10 Ratio | 4.10 | 035410 |
| Wrangler [YJ,TJ] 87-06, Cherokee [XJ] 84-01, Dana 35 Rear, 4.56 Ratio | 4.56 | 035456 |
| Wrangler [YJ,TJ] 87-06, Cherokee [XJ] 84-01, Dana 35, 4.88 Ratio | 4.88 | 035488 |
| Wrangler [TJ] 97-06, Rear Dana 44, 3.73 Ratio | 3.73 | 044373 |
| Wrangler [TJ] 97-06, Rear Dana 44, 4.10 Ratio | 4.10 | 044410 |
| Wrangler [TJ] 97-06, Rear Dana 44, 4.56 Ratio | 4.56 | 044456 |
| Wrangler [TJ] 97-06, Rear Dana 44, 4.88 Ratio | 4.88 | 044488 |
| Wrangler [TJ] 97-06, Rear Dana 44, 5.13 Ratio | 5.13 | 044513 |
| Wrangler [TJ] Rubicon 03-06, Front/Rear Dana 44, 4.88 Ratio | 4.88 | 044488X |
| Wrangler [TJ] Rubicon 03-06, Front/Rear Dana 44, 5.13 Ratio | 5.13 | 044513X |
| Wrangler [JK] 07-12, Rear 7/16 Bolts, Dana 44, 4.10 Ratio NEW* | 4.10 | 044410JK |
| Wrangler [JK] 07-12, Rear Dana 44, 4.88 Ratio NEW* | 4.88 | 044488JK |
| Wrangler [JK] 07-12, Rear Dana 44, 5.13 Ratio NEW* | 5.13 | 044513JK |
| Cherokee [XJ] 91-01, Chrysler 8.25", 3.55 Ratio NEW | 3.55 | 083355 |

*2012 and up models may require an aftermarket programmer to sync the new gear ratio to the transmission controller

RING & PINION MASTER INSTALLATION & OVERHAUL KITS FOR JEEP®

These great kits offer all the components you will need to complete your differential rebuild or ring & pinion installation. Complete with bearings, pinion seals, pinion shims, crush sleeve, pinion nut, ring gear bolts and marking compound.



| Application | Part # |
|--|--------|
| CJ5, CJ7, CJ8 72-86, Dana 30, Front | 352065 |
| CJ5, CJ7, CJ8, 72-86, AMC Model 20 | 352025 |
| CJ5, CJ7, 72-75, Dana 44 Rear | 352033 |
| Wrangler [YJ] 87-95, Cherokee [XJ] 84-91, Dana 30 Front | 352032 |
| Wrangler [YJ, TJ] 87-06, Cherokee [XJ] 84-01, Dana 35 Rear | 352049 |
| Wrangler [TJ] 97-06, Cherokee [XJ] 92-01, Dana 30 Front | 352031 |
| Wrangler [TJ] 97-06, Dana 44 Rear | 352033 |
| Wrangler [TJ] Rubicon 03-06, Dana 44 Front/Rear | 352045 |
| Wrangler [JK] 07-12, Dana 30, Front [NEW] | 352050 |
| Wrangler [JK] 07-12, Dana 44, Front [NEW] | 352051 |
| Wrangler Rubicon [JK] 07-12, Dana 44, Rear [NEW] | 352052 |
| Wrangler X, Sahara [JK] 07-12, Dana 44, Rear [NEW] | 352053 |
| Grand Cherokee [WJ] 99-04, Dana 35, Rear | 352061 |
| Grand Cherokee [WJ] 99-00, Before 3/29/00, Dana 44, Rear | 352062 |
| Grand Cherokee [WJ] 00-04, After 3/29/00, Dana 44, Rear | 352063 |
| Grand Cherokee [XJ] 91-01, Chrysler 8.25, Rear | 352064 |
| Grand Cherokee [ZJ] 93-98, Dana 35 Rear | 352049 |
| Grand Cherokee [ZJ] 93-98, Dana 30 Front | 352031 |

HD DIFFERENTIAL COVERS

Indestructible! You won't break these covers, we guarantee it. Made from either 3/8" cast steel or 5/16" stamped steel, painted black inside and out, these heavy-duty covers are designed to protect your differential and all its working parts for as long as you own your vehicle. These indestructible covers have been ".44 caliber tested" - if they can take a bullet at point blank range (don't try this at home!), they can take all that the trail has to offer. Available for most popular Dana differential types and include extra reinforcement protection for the fill plug area. All mounting hardware and instructions are included for ease of installation.

| Differential Cover Application | Cast 3/8" Steel | | Stamped 5/16" Steel | |
|--------------------------------|-----------------|--------|---------------------|--------|
| | Part # | Part # | Part # | Part # |
| HD AMC 20 | 11205 | - | - | - |
| HD Dana 30 | 11206 | - | 11200 | - |
| HD Dana 35 | 11201 | - | - | - |
| HD Dana 44 | 11202 | - | - | - |
| HD Dana 60 | 11207 | - | 11203 | - |



11206



11200

All images are subject to be representative. More detailed information is available online.

WHEEL SPACERS

- Moves your wheels out to help fit wider tires-creates extra stability.
- Hub centric design to assure wheel balance.
- Constructed of durable 6061T6 aluminum for long life, extra strength and corrosion resistance.
- Available in 1.25" to 1.5" widths for today's most popular wheel sizes.
- Each pair includes pre-installed grade 8 wheel studs, 10 lug nuts and thread locker.
- Wheel adaptors convert current bolt patterns to alternate bolt patterns for use with different wheels.
- Wheel Spacers and Wheel adaptors are sold in pairs.



WHEEL SPACERS

| APPLICATION | Width | Bolt Pattern | Part # |
|------------------------------------|-------|--------------|--------|
| Jeep CJ 1945-1986 NEW | 1.25" | 5 on 5.5" | 11302 |
| Jeep Cherokee 1984-2001 NEW | 1.25" | 5 on 4.5" | 11301 |
| Jeep Wrangler 1987-2006 NEW | 1.25" | 5 on 4.5" | 11301 |
| Jeep Wrangler 2007-2012 NEW | 1.50" | 5 on 5.0" | 11300 |

WHEEL ADAPTORS

| APPLICATION | Width | Conversion | Part # |
|--|-------|------------------------|--------|
| Jeep Wrangler 1987-2006, Cherokee 1984-2001, Pair NEW | 1.25" | 5 on 4.5" to 5 on 5.5" | 11310 |



SLOTTED BRAKE ROTORS

Alloy USA® slotted & drilled brake rotors improve braking performance right out of the box. Slotted & drilled for maximum cooling! Slotted rotors improve brake pad bite & reduce brake fade.

| APPLICATION | Part # |
|--|--------|
| 1990-1999 Wrangler, 1990-1999 Cherokee (4WD Only), Disc Brake Rotor (Front) NEW | 11350 |
| 2000-2006 Wrangler, 2000-2001 Cherokee, Disc Brake Rotor (Front) NEW | 11351 |
| 2002-2007 Liberty, 2003-2006 Wrangler, Disc Brake Rotor (Rear) NEW | 11352 |

ALLOY USA® FRONT AXLE X-JOINT COLD FORGED · SERVICEABLE

| APPLICATION | Part # |
|--|--------|
| Heavy Duty Alloy X-joint, Complete U-joint With Bearings (760 Style) Replaces 5-297X/5-760X NEW | 11500 |

Now a serviceable U-joint for Dana 44 applications is available to you. Replace your 760X U-joint with Alloy USA's new X-joint!



OTHER U-JOINTS

Direct OE replacement



| APPLICATION | Part # |
|--|----------|
| U-Joint, Dana 44 Front, Jeep Wrangler (JK) Rubicon 07-12 NEW | 16525.08 |
| 1310-1330 Conversion U-Joint, 94-97 Wrangler for CV Driveshaft, 94-04 Mustang 4.6L | 5-134X |

Alloy USA & Precision Gear

DANA 60 / 70 YOKE 1410 SERIES

Genuine Dana Spicer NOS yoke for 1410 series U-Joint. Some oxidization may have occurred during shelf life.



| Application | Part # |
|--|-------------|
| Dana 60 / 70 Yoke 1410 Series NEW | 3-4-5711-1X |

YOKE CONVERSION KITS

These great Conversion Kits allow you to convert your old strap style yoke to the newer stronger u-bolt design. Not only it the U-bolt kit stronger, it makes changing out a failed U-joint a painless process. The kit includes a new yoke, pinion nut, pinion spacer, pinion seal, u-joint and u-bolts. Alloy USA uses premium Spicer U-joints in all their yoke kits.



YOKE CONVERSION KITS - Converts Strap To U-Bolt Design, Includes Spicer U-Joint & U-Bolts

| Application | Part # |
|---|--------|
| CJ5 76-81, CJ7, CJ8 76-86, AMC 20 | 380003 |
| CJ5, CJ7, CJ8, 72-86, Wrangler (YJ, TJ) 87-06, Cherokee (XJ) 84-01, Dana 30 | 380001 |
| Wrangler (YJ) 87-93, Wrangler (TJ) 97-02, Cherokee (XJ) 84-95, Dana 35 | 380002 |



DIFFERENTIAL CABLE LOCK KITS

The Alloy USA® Differential Cable Lock Kit is a permanent replacement for the failure prone OE vacuum disconnect system. The kit allows you to engage and lock the front axle from inside the cab. A 1inch pull of the cable ensures you will have four wheel drive when you need it for as long as the transfer case is engaged. The Differential Cable Lock Kit is more cost effective and easier to install than a locker or posi-trac system. Backed by a three year warranty.

| APPLICATION | Part # |
|---|--------|
| Shift Fork, Cast Iron, For Use w/ Alloy USA or Posi Lok Differential Cable Lock Kit, Jeep W/ Front Dana 30 Wrangler [YJ] 87-95, Cherokee [XJ] 84-91 NEW | 450100 |
| Differential Cable Lock Kit, With D44 or D60 Axle, Dodge 1500 1994-2001, 2500 1994-2004 NEW | 450400 |
| Differential Cable Lock Kit, Dodge Ramcharger 85-93 NEW | 450450 |
| Differential Cable Lock Kit, GM 83-99 S/T 10 & 15, Blazer, Jimmy w/ Vacuum Actuator NEW | 450500 |
| Differential Cable Lock Kit, GM 88-98 1500 / 2500 6-Lug, Chevrolet 92-98 Suburban / Tahoe / Yukon 6-Lug NEW | 450600 |
| Differential Cable Lock Kit, Ford F150 97-03 4X4 NEW | 450750 |
| Differential Cable Lock Kit, GM 88-98 2500 / 3500 8-Lug, Chevrolet 92-98 Suburban / Tahoe / Yukon 8-Lug NEW | 450800 |
| Differential Cable Lock Kit, With Front D30 Axle, Jeep Wrangler [YJ] 1987-1995, Cherokee [XJ] 1984-1991 NEW | 450900 |
| Differential Cable Lock Kit, For 3-In To 6-In Lift, With Front D30 Axle, Jeep Wrangler [YJ] 1987-1995, Cherokee [XJ] 1984-1991 NEW | 450920 |
| Differential Permanent Cable Lock Kit, GM 88-98 1500 / 2500 6-LUG, 88-98 1500 / 2500 8-Lug, Chevrolet 92-98 Suburban / Tahoe / Yukon 6-Lug, Chevrolet 92-98 Suburban / Tahoe / Yukon 8-Lug NEW | 451000 |
| Differential Permanent Cable Lock Kit, Jeep w/ Front D30 Wrangler [YJ] 87-95, Cherokee [XJ] 84-91; Dodge W/ D44 or D60 1500 94-01, 2500 94-04 NEW | 451100 |

TRANSFER CASE CHAIN



If you're servicing your transfer case and your OE chain has more than 60,000 miles on it, it is time for a replacement. Why replace your chain when can upgrade it? Our advanced Round Pin technology allows the chain to double back on itself and offer greater articulation than the standard rocker pin design. We use high tensile strength steel to ensure that your TC chain endures peak loads under heavy operating conditions repeatedly over time. Backed by an industry leading three year warranty.

| Transfer Case Chain | Part # |
|---|--------|
| Transfer Case Chain, NP231 and NP233, 1" Width w/ 30 Links, Jeep Wrangler [YJ] 87-95, [TJ] 97-06, Cherokee [XJ] 84-01, Grand Cherokee [ZJ] 93-97 NEW | 11650 |
| Quadratrac Transfer Case Chain, 2 5/8" Width w/ 48 Links, CJ7 76-79 w/ Automatic Transmission NEW | 11651 |

TRANSFER CASE SLIP YOKE ELIMINATOR KIT

This kit is a MUST if you installed a 2" or taller suspension lift in your 1988-2006 Wrangler (not needed for body lifted Jeeps®). The kit fits all 1988 and up NP 231 transfer cases. A Slip Yoke Eliminator Kit [SYE] will eliminate the need to drop your transfer case in order to avoid drive train vibrations that are caused by taller suspension lift. The purpose of this kit is to replace the slip yoke portion of the NP 231 with a fixed yoke and CV-style drive shaft assembly. This reduces drive shaft angle, improves bearing & U-joint life, reduces driveline vibrations. It also has a shorter and stronger main shaft design with improved oiling. Will not work with cable driven speedometers. Not for use with Rubicon models.



11400 Slip Yoke Eliminator Kit

WARNING:

WARNING: OEM slip yokes on 1988-2006 Jeep® Wrangler are not suitable for use with 2" or taller Rugged Ridge® or other vendors' suspension lifts. Failure of slip yoke may result in damage to transfer case and/or loss of vehicle control. Use of this slip yoke eliminator kit is required for all suspension lifts 2" or taller. See additional product safety information and WARNINGS at back of catalog.

| Transfer Case Slip Yoke Eliminator Kit | Part # |
|--|----------|
| 88-06 Wrangler, 88-01 Cherokee Slip Yoke Eliminator [with NP231 transfer case] *, Kit NEW | 11400 |
| Pinion Yoke | 18676.61 |
| Oil Seal | 18676.62 |
| Hardware Kit | 18676.64 |

* A CV Driveshaft is required for this conversion kit

ALLOY USA® AXLE TUBE SEALS

Keep water, mud and debris from entering your front axle housing. These CNC machined aluminum housings feature two seals to provide double protection from the crud.



| APPLICATION | Part # |
|--|------------------------------|
| 1984-06 Wrangler [YJ,TJ] Cherokee [XJ] Grand Cherokee [ZJ] Dana 30 (1) | 11102 (RED) 11103 (BLACK) |
| 1984-06 Wrangler [YJ,TJ] Cherokee [XJ] Grand Cherokee [ZJ] 2007-12 Wrangler w/ Grande Axles [JK] Dana 30 or 44 front axle (2) NEW | 11105 (RED) 11106 (BLACK) |
| Replacement Inner Seal For 11102 and 11103 NEW | 11108 |
| Replacement Inner Seal For 11105 and 11106 NEW | 11109 |

[1] Note: Will not fit 87-95 Wranglers with O.E. front disconnect axle. Must upgrade to one piece axle. Will not fit Grande 30 spine axles. For 27 Spline applications only.

[2] Note: Will not fit 87-95 Wranglers with O.E. front disconnect axle. Must upgrade to 1 pc 30 spline grand axle. For use with all grande 30 spline axle upgrades & Rubicon Dana 44's.

LOCK RIGHT® LOCKERS

The Powertrax® Lock-Right® Lockers performance is equal to a solid spool axle, yet automatically unlocks to allow full differentiation in turns. The locker also reduces the excessive noise, tire wear, and drivetrain damage associated with other lockers. Powertrax lockers replace the spider gears in your differential carrier without affecting your ring and pinion settings. The whole job can be done in your driveway with common hand tools in a couple of hours. A carrier is not included. Whether it be snow, sand, mud, ice, etc... the LOCK-RIGHT will give you the traction you need.

| Application | Part # |
|--|----------|
| Lock Right Rear 1945-49 CJ 'S With Dana-41 | LR2416 |
| Lock Right Rear 1945-62 CJ 'S With 10-Spline Dana-44 | LR2415 |
| Lock Right Front 1945-64 CJ 's Dana-25 & 1964-71 CJ Dana-27 | LR2115 |
| Lock Right Rear 1955-71 CJ 'S With 19-Spline Dana-44 | LR2413 |
| Lock Right Rear 1972-86 CJ 'S With 30-Spline Dana-44, Also 1997-02 TJ | LR2410 |
| Lock Right Front 1972-03 CJ, YJ, TJ | LR2210 |
| Lock Right Rear 1976-86 CJ 'S With AMC-20 | LR1710 |
| Lock Right Rear 1987-93 YJ Dana-35 [Except 1993 W/ 605528 BOM] [Plus Z-Shaft] | LR2310S |
| Lock Right Rear 1994-03 YJ & TJ Dana-35 [Also 1993 YJ 605528 BOM] [Plus Z-Shaft] | LR2311S |
| Lock Right Chrysler 8.25" 10-Bolt 27-Spline 1991-1996 Cherokees | LR1230 |
| Lock Right Chrysler 9.25" 12-Bolt 31-Spline | LR1220 |
| Lock Right Zytanium CrossShaft, Rear AMC-20 [1976-1986 CJ] | LRSA1710 |
| Lock Right Zytanium CrossShaft, Front Dana-30 [1972-03 CJ, YJ, TJ] | LRS02210 |
| Lock Right Zytanium CrossShaft, Rear Dana-44 [1972-86 CJ, 1997-02 TJ] | LRS02410 |

**DETROIT LOCKERS®**

| Application | Part # |
|--|-----------|
| Detroit Locker, Soft Locker, Locking Differential, AMC 20 3.08 to 4.88 Ratio, Jeep CJ 76-86 | 187SL47A |
| Detroit Locker, Truetrac, Limited Slip Differential, Dana 30 27 Spline 3.07 to 3.54 Gear Ratio, Jeep CJ 72-86, Wrangler [YJ] 87-95, [TJ] 97-06, Cherokee [XJ] 84-01, Grand Cherokee [ZJ] 93-98 | 912A584 |
| Detroit Locker, Truetrac, Limited Slip Differential, Dana 30 27 Spline 3.73 to 3.54 Gear Ratio, Jeep CJ 72-86, Wrangler [YJ] 87-95, [TJ] 97-06, Cherokee [XJ] 84-01, Grand Cherokee [ZJ] 93-98 | 912A585 |
| Detroit Locker, Soft Locker, Locking Differential, Dana 30 3.73 to 5.38 Ratio, Jeep CJ 72-86, Wrangler [YJ] 87-95, [TJ] 97-06, Cherokee [XJ] 84-01, Grand Cherokee [ZJ] 93-98, [WJ] 99-02, | 162SL60B |
| Detroit Locker, Truetrac, Limited Slip Differential, Dana 30 3.73 to 5.38 Ratio, Jeep CJ 72-86, Wrangler [YJ] 87-95, [TJ] 97-06, Cherokee [XJ] 84-01, Grand Cherokee [ZJ] 93-98, [WJ] 99-02, | 912A314 |
| Detroit Locker, Limited Slip Differential, Dana 35 27 Spline 3.54 to 5.38 Gear Ratio, Jeep Wrangler [YJ] 87-95, [TJ] 97-06, Cherokee [XJ] 90-01 | 162C56A |
| Detroit Locker, Truetrac, Limited Slip Differential, Dana 35 27 Spline 3.54 to 5.38 Gear Ratio, Jeep Wrangler [YJ] 87-95, [TJ] 97-06, Cherokee [XJ] 84-01, Grand Cherokee [ZJ] 93-98, [WJ] 99-04 | 912A569 |
| Detroit Locker, Limited Slip Differential, Dana 35 30 Spline 3.54 TO 5.38, Jeep Wrangler [YJ] 87-95, [TJ] 97-06, Cherokee [XJ] 90-01 | 162C66A |
| Detroit Locker, Differential, Super Dana 44 33 SPLINE 3.92 + Gear Ratio, Jeep 66-68 | 187SL192A |
| Detroit Locker, Truetrac, Limited Slip Differential, Dana 44 30 Spline 2.73 to 3.73 Gear Ratio, Jeep CJ5 72-75, CJ7 86, Wrangler [TJ] 97-06 | 913A589 |
| Detroit Locker, Soft Locker, Locking Differential, Dana 44 30 Spline 2.73 to 3.73 Gear Ratio, Jeep CJ5 72-75, CJ7 86, Wrangler [TJ] 97-06 | 187SL16D |
| Detroit Locker, Truetrac, Limited Slip Differential, Dana 44 30 Spline 3.92 to 5.38 Gear Ratio, Jeep CJ5 72-75, CJ7 86, Wrangler [TJ] 97-06 | 913A590 |
| Detroit Locker, Truetrac, Limited Slip Differential, Dana 44 Front 30 Spline 2.73 TO 3.73 Gear Ratio, Jeep Wrangler [TJ] 03-06 | 913A591 |
| Detroit Locker, Soft Locker, Locking Differential, Dana 44 3.92 to 5.38 Ratio, 30 Spline, Jeep CJ 72-75 & 86, Wrangler [TJ] 97-06, Cherokee [XJ] 84-01, Grand Cherokee [ZJ] 93-98, [WJ] 99-02 | 187SL16C |

ARB® LOCKERS

| Application | Part # |
|---|-----------|
| ARB Air Locker, 1970-03 CJ, MJ, TJ, ZJ, WJ, SJ Dana 44 30 Spline 3.92 & UP Ratio | ARB-RD06 |
| ARB Air Locker, 1970-03 CJ, MJ, TJ, ZJ, WJ, SJ Dana 44 30 Spline 3.73 & DOWN Ratio | ARB-RD07 |
| ARB Air Locker, 1972-03 CJ, XJ, YJ, TJ, ZJ, WJ Dana 30 27 Spline 3.73 & UP Ratio | ARB-RD100 |
| ARB Air Locker, 1972-03 CJ, XJ, YJ, TJ, ZJ, WJ Dana 30 27 Spline 3.54 & DOWN Ratio | ARB-RD101 |
| ARB Air Locker, 1976-86 CJ & SJ AMC 20 29 Spline 3.08 & Up Ratio | ARB-RD60 |
| ARB Air Locker, 1990-06 YJ, TJ, XJ, ZJ Dana 35 W/C-CLIP 27 Spline 2.73-3.31 Ratio | ARB-RD103 |
| ARB Air Locker, 1990-06 YJ, TJ, XJ, ZJ Dana 35 W/C-CLIP 27 Spline 3.54 & UP Ratio | ARB-RD102 |
| ARB Air Locker, 1997-04 Grand Cherokee, 02-07 Liberty, Chrysler 8.25" 29 Spline, All Ratios | ARB-RD93 |
| ARB Air Locker, Super Dana 30, 3.73 and Up Ratio | ARB-RD104 |
| ARB Air Locker, Super Dana 35, C-CLIP, 30 SPL, 3.54 and Up Ratio | ARB-RD105 |

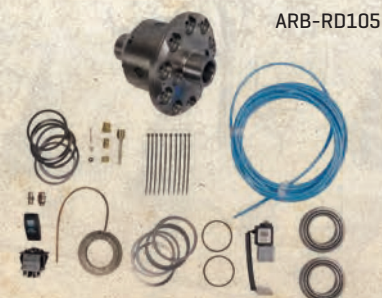



RING & PINION

Precision Gear® understands the rigors of racing. Horsepower is useless unless you can get it to the ground. Most companies providing ring and pinions today look for the cheapest source without consideration of quality. They “stand behind” their product until the day you buy it and install it on your car. At Precision Gear® each ring and pinion we sell is backed by an exclusive five year warranty! Our gears are made from high quality 8620 forgings and Gleason gear cutting technology because our gears are made to last!



For additional product listings and more information visit www.precisiongear.com.

Master Installation Kits:

Precision Gear® understands the complexity of rebuilding your differential. To help solve this difficulty and eliminate multiple trips to the parts store we have included everything you need to complete your ring & pinion installation and get you back on the road quick all in one great kit.

Master Install Kit Includes:

- Carrier Bearings
- Pinion Bearings
- Pinion Nut
- Pinion Seal
- Preload Shims or Crush Collar
- Pinion Shims
- Gasket or RTV
- Marking Compound
- Differential Shims (where applicable)
- Locktite
- Oil Slingers (where applicable)
- Ring Gear Bolts (where applicable)

* Ring & Pinions and Installation Kits are sold separately.

| Dana 30 | | Dana 44 | | Chrysler 9.25 | |
|-------------------------|-----------|-------------------------|-----------|-------------------------|----------|
| Ratio | Part # | Ratio | Part # | Ratio | Part # |
| 3.07 | 30D/307 | 3.23 | 44D/323 | 3.55 | CRY/355 |
| 3.54 | 30D/354 | 3.31 | 44D/331 | 4.10 | CRY/410 |
| 3.73 | 30D/373 | 3.42 | 44D/342 | | |
| 3.91 | 30D/391 | 3.54 | 44D/354 | | |
| 4.10 | 30D/410 | 3.73 | 44D/373 | | |
| 4.56 | 30D/456 | 4.09 | 44D/409 | | |
| Master Installation Kit | 352032 | 4.27 | 44D/427 | | |
| Spider Gear Kit (NEW) | 305D/SPGK | 4.56 | 44D/456 | | |
| | | 4.56 | 44D/456TH | | |
| | | 4.88 | 44D/488 | | |
| | | 4.88 | 44D/488TH | | |
| | | 5.13 | 44D/513 | | |
| | | Master Installation Kit | 352033 | | |
| | | | | | |
| Dana 35 | | Dana 44 Reverse | | Ford 8.8" | |
| Ratio | Part # | Ratio | Part # | Ratio | Part # |
| 3.55 | 35D/355 | 3.07 | 44D/307R | 3.55 | F88/355 |
| 3.73 | 35D/373 | 3.50 | 44D/350R | 3.73 | F88/373 |
| 4.10 | 35D/410 | 3.54 | 44D/354R | 4.10 | F88/410 |
| 4.56 | 35D/456 | 3.73 | 44D/373R | 4.10 | F88/410R |
| 4.88 | 35D/488 | 4.09 | 44D/409R | 4.30 | F88/430 |
| Master Installation Kit | 352049 | 4.56 | 44D/456R | 4.56 | F88/456 |
| | | 4.88 | 44D/488R | 4.88 | F88/488 |
| | | 5.13 | 44D/513R | Cross Shaft - Small | F88/XSM |
| | | Master Installation Kit | 352033A | Cross Shaft - Large | F88/XSLM |
| | | | | Master Installation Kit | 352013 |
| Dana 35 Reverse | | Dana 70 | | Ford 9" | |
| Ratio | Part # | Ratio | Part # | Ratio | Part # |
| 4.56 | 35D/456R | 4.10 | 706D/410 | 3.08 | F9/308 |
| 4.88 | 35D/488R | 5.86 | 706D/586 | 3.25 | F9/325 |
| 5.13 | 35D/513R | | | 3.50 | F9/350 |
| Master Installation Kit | 352049A | | | 3.70 | F9/370 |
| | | | | 3.89 | F9/389 |
| | | | | 4.11 | F9/411 |
| | | | | 4.30 | F9/430 |
| | | | | 4.57 | F9/457 |
| | | | | Master Installation Kit | 352011 |
| | | | | Master Installation Kit | 352011A |
| Dana 60 | | AMC 20 | | Ford 10.25" (1985-92) | |
| Ratio | Part # | Ratio | Part # | Ratio | Part # |
| 3.54 | 60D/354 | 3.08 | AMC/308 | 3.55 | F10/355S |
| 3.73 | 60D/373 | 3.54 | AMC/354 | 3.73 | F10/373E |
| 4.10 | 60D/410 | 3.73 | AMC/373 | 4.10 | F10/410S |
| 4.56 | 60D/456 | 4.10 | AMC/410 | 4.56 | F10/456S |
| 4.56 | 60D/456R | 4.56 | AMC/456 | Master Installation Kit | 352046 |
| 4.88 | 60D/488 | Master Installation Kit | 352025 | | |
| 5.13 | 60D/513 | | | | |
| 5.13 | 60D/513R | | | | |
| Master Installation Kit | 352034 | | | | |

All images are subject to be representative. More detailed information is available online.



PRECISION GEAR RING AND PINIONS:

Precision Gear® understands the rigors of racing. Horsepower is useless unless you can get it to the ground. Most companies providing ring and pinions today look for the cheapest source without consideration of quality. They “stand behind” their product until the day you buy it and install it on your car. At Precision Gear® each ring and pinion we sell is backed by an exclusive five year warranty! Our gears are made from high quality 8620 forgings and Gleason gear cutting technology because our gears are made to last!

For additional product listings and more information visit www.precisiongear.com.

| GM 8.5" | | GM 8-7/8" | | Ford 10.25 (1993-98) | |
|-------------------------|----------|-------------------------|----------|-------------------------|----------|
| Ratio | Part # | Ratio | Part # | Ratio | Part # |
| 3.08 | GM10/308 | 3.08 | GM12/308 | 3.55 | F10/355L |
| 3.42 | GM10/342 | 3.42 | GM12/342 | 3.73 | F10/373L |
| 3.73 | GM10/373 | 3.73 | GM12/373 | 4.10 | F10/410L |
| 3.90 | GM10/390 | 4.10 | GM12/410 | 4.56 | F10/456L |
| 4.10 | GM10/410 | 4.56 | GM12/456 | 4.88 | F10/488L |
| 4.56 | GM10/456 | 4.88 | GM12/488 | 5.13 | F10/513L |
| 4.88 | GM10/488 | Master Installation Kit | 352018 | Master Installation Kit | 352046 |
| Master Installation Kit | 352021 | | | | |

| GM 9.5" | | GM 10.5 | | GM 9.25" | |
|-------------------------|---------|------------------|-----------|-------------------------|----------|
| Ratio | Part # | Ratio | Part # | Ratio | Part # |
| 3.42 | GM9/342 | 3.73 | GM14/373 | 4.10 | GM9F/410 |
| 3.73 | GM9/373 | 4.10 | GM14/410 | 4.56 | GM9F/456 |
| 4.10 | GM9/410 | 4.56 | GM14/456 | 4.88 | GM9F/488 |
| 4.56 | GM9/456 | 4.56+ | GM14/456+ | 5.13 | GM9F/513 |
| 4.88 | GM9/488 | 4.88+ | GM14/488+ | Master Installation Kit | 352096 |
| 5.13 | GM9/513 | 5.13+ | GM14/513+ | | |
| Master Installation Kit | 352010 | Mini Spool | GM14/MSPL | | |
| | | 1987 and earlier | 352023 | | |
| | | 1988 and later | 352023A | | |

| Toyota 8" Tacoma | | Toyota 8" 200mm | | Toyota 8" V6/Turbo | |
|-------------------------|---------|-------------------------|---------|-------------------------|----------|
| Ratio | Part # | Ratio | Part # | Ratio | Part # |
| 4.56 | TAC/456 | 3.54 | TOY/354 | 4.11 | TOY/411T |
| 4.88 | TAC/488 | 4.11 | TOY/411 | 4.56 | TOY/456T |
| 5.29 | TAC/529 | 4.56 | TOY/456 | 4.88 | TOY/488T |
| Master Installation Kit | 352055 | 4.88 | TOY/488 | 5.29 | TOY/529T |
| | | 5.29 | TOY/529 | Master Installation Kit | 352043 |
| | | Master Installation Kit | 352041 | | |

| Toyota 7.5" Tacoma | | Toyota Landcruiser | |
|-------------------------|----------|--------------------|---------|
| Ratio | Part # | Ratio | Part # |
| 4.56 | TAC/456R | 4.88 | LC/488 |
| 4.88 | TAC/488R | 4.88 | LC/488R |
| 5.29 | TAC/529R | 5.29 | LC/529 |
| Master Installation Kit | 352056 | | |

Alloy USA & Precision Gear





The following section contain all the parts you need for restoring & repairing your Jeep®! From 1941 to current, Omix® has you covered. If you know Jeep, you know Omix®!



OFFICIAL LICENSED PRODUCT

MOPAR, JEEP, DODGE, HEMI, PLYMOUTH, RAM, and CHRYSLER vehicles, images and logos are trademarks of Chrysler Group LLC used under license to Omix-Ada®. © Chrysler Group LLC 2011



AUTHENTIC RESTORATION PRODUCT

MOPAR, JEEP, DODGE, HEMI, PLYMOUTH, RAM, and CHRYSLER vehicles, images and logos are trademarks of Chrysler Group LLC used under license to Omix-Ada®. © Chrysler Group LLC 2011

Look for the star to check out all the Mopar Licensed Products

This emblem is Mopar's "Seal Of Approval" that the product meets their standards and is truly a licensed product.

Parts identified with the Mopar Authentic Restoration Product emblem are the only parts in this catalog officially authorized and licensed by Chrysler Group LLC.

A Few Words About Product Safety: To help you make informed decisions about safety; this catalog and the instructions accompanying our products have provided certain information in the form of "Notices", "Warnings" and "Cautions". This information alerts you to potential hazards that could hurt you or others.

NOTICE

This is a caution against anything which may cause damage to the vehicle or its equipment if the caution is ignored. The Notice includes information about how you can avoid or reduce those risks.

WARNING

This is a signal telling you that **you CAN be KILLED or SERIOUSLY HURT if you don't follow the Warning.** The Warning includes information about what you must or must not do in order to reduce the risk of injury to yourself and others.

CAUTION

This is a signal telling you that **you or others CAN be HURT if you don't follow the instruction.** The Caution includes information about how you can avoid those risks.

! WARNING

Your safety and the safety of other motorists is very important. Your Jeep® is an off road capable vehicle that readily lends itself to restoration and customization. As the owner of a modified suspension vehicle you are the person choosing the combination of suspension, wheels, tires, drive train and accessories that best fit your intended use. Likewise, you are the person responsible for the safety and legality of the vehicle you modify. In modifying your vehicle's suspension, balance your off-road capabilities against how the vehicle may actually be used off-road and on-road.

It is not practical or possible to warn about all hazards associated with your Jeep® restoration or modifying your suspension for improved off road capabilities. Start by familiarizing yourself with all vehicle manufacturers' instructions and warnings and the instructions and warnings accompanying your aftermarket product. Follow recommended maintenance procedures and routinely inspect your vehicle components for unusual wear or off-road damage. Restoration parts are direct replacements of original components and are not designed or warranted as meeting current safety standards (including FMVSS).

Always wear seat belts and/or appropriate off-road restraints, reduce your speed, tread lightly® and safely enjoy your off-road vehicle.

A FEW WORDS ABOUT PARTS AVAILABLE FROM THIS CATALOG.

PARTS IDENTIFIED AS MOPAR® APPROVED AUTHENTIC RESTORATION PRODUCTS™ REFLECT THAT THE PRODUCT IS LICENSED BY MOPAR® FOR MANUFACTURE BY THIRD PARTIES AND MEETS MOPAR® STANDARDS. OMIX-ADA® AND ITS LICENSEES ARE NOT AFFILIATED WITH CHRYSLER GROUP LLC. ALL PARTS LISTED ARE AFTERMARKET ORIGIN AND PART NUMBERS ARE FOR PURPOSES OF CROSS-REFERENCE ONLY. THE RUGGED RIDGE®, OUTLAND®, ALLOY USA®, AND PRECISION GEAR® PARTS ARE OMIX-ADA® BRANDED PRODUCTS MANUFACTURED BY QUALIFIED THIRD PARTIES. PARTS LISTED OTHER THAN MOPAR® APPROVED RESTORATION PARTS, ARE SUPPLIED BY QUALIFIED OMIX-ADA® VENDORS WORLDWIDE. THIS CATALOG MAY BE REPRODUCED BY INDEPENDENT RETAILERS UNDER LICENSE FROM OMIX-ADA®.

THIS CATALOG REPRODUCED UNDER LICENSE FROM OMIX-ADA INC. PARTS IDENTIFIED WITH THE MOPAR AUTHENTIC RESTORATION PRODUCT EMBLEM ARE THE ONLY PARTS IN THIS CATALOG OFFICIALLY AUTHORIZED AND LICENSED BY CHRYSLER GROUP LLC.

ALL RIGHTS RESERVED. NO PART OF THIS CATALOG MAY BE REPRODUCED BY ANY MEANS, ELECTRONIC OR OTHERWISE, WITHOUT EXPLICIT WRITTEN AUTHORIZATION FROM OMIX-ADA, INC. © COPYRIGHT OMIX-ADA, INC.

BY ORDERING FROM THIS CATALOG THE PURCHASER AGREES TO THE FOLLOWING TERMS AND CONDITIONS: THIS CATALOG IS BEING DELIVERED AS IS AND OMIX-ADA®, INC. OR LICENSEE MAKE NO WARRANTIES, EXPRESSED OR IMPLIED, ON MERCHANTABILITY OR FITNESS FOR ANY PARTICULAR PURPOSE. OMIX-ADA®, INC. OR LICENSEE DISCLAIM ALL LIABILITY FOR DIRECT OR INDIRECT DAMAGES ARISING FROM THE USE OR PERFORMANCE OF THIS CATALOG OR THE PRODUCTS HEREIN. DEFECTIVE ITEMS WILL BE CREDITED OR REPLACED AT OMIX®'S SOLE DISCRETION. OMIX® IS NOT RESPONSIBLE FOR LABOR, CONSEQUENTIAL DAMAGES OR BODILY INJURIES ARISING FROM INSTALLING OR USING ITS PARTS, CATALOG OR LISTINGS. NO RETURNS ARE ALLOWED ON SPECIAL ORDERS, FACTORY DROPSHIPS, ELECTRICAL AND BODY PARTS. OMIX-ADA® OR LICENSEE ARE NOT RESPONSIBLE FOR TECHNICAL ERRORS, OMISSIONS OR PRINTING ERRORS. PRICES, AVAILABILITY AND BRAND NAMES ARE SUBJECT TO CHANGE WITHOUT NOTICE.

JEEP®, WILLYS®, AMC™, WRANGLER™, CHEROKEE™, GRAND CHEROKEE™, LIBERTY™, CJ™, YJ™, XJ™, TJ™, JK™, ZJ™, WJ™, SJ™, KJ™, JEEP® GRILLE DESIGN AND OTHER NAMES USED IN THIS CATALOG ARE TRADEMARKS OF CHRYSLER GROUP LLC. OMIX-ADA® OR ITS LICENSEES ARE NOT AFFILIATED WITH CHRYSLER GROUP LLC. ALL PARTS LISTED ARE AFTERMARKET REPLACEMENT PARTS. PART NUMBERS, ILLUSTRATIONS AND IMAGES USED FOR REFERENCE PURPOSE ONLY. NO IMPLICATION IS MADE THAT THESE ARE ORIGINAL EQUIPMENT PARTS, FROM THOSE SOURCES WHOSE PART NUMBERS ARE USED HERE FOR REFERENCE OR THAT THEY ARE APPROVED BY THOSE COMPANIES.

© OMIX-ADA®, INC. 2011. ALL RIGHTS RESERVED.

All images are subject to be representative. More detailed information is available online.

Table of Contents

| | |
|-------------------|------|
| Body | R1 |
| Axle | R24 |
| Driveshafts | R37 |
| Brakes | R38 |
| Clutch & Flywheel | R48 |
| Cooling | R52 |
| Electrical | R57 |
| Engine | R68 |
| Exhaust | R77 |
| Fuel | R80 |
| Heating & AC | R85 |
| Steering | R86 |
| Suspension | R91 |
| Transfer Case | R95 |
| Transmission | R100 |
| Wipers | R109 |
| Surplus | R111 |



Replacement Body Tubs, Panels & Parts for Jeep®

- » Replace Steel Body Tubs and Body Kits from 1941 - 1995
- » Replacement Body Panels from 1941 - 2012
- » Jeep®/Willys Licensed Body Tubs, Kits & Panels Available!
- » Body Tubs are completely assembled, and primed. Ready to be shipped to your door.
- » 16 gauge steel used on body tubs for all side and tail panels. In most cases it is thicker than original!
- » 18 Gauge steel used on body tubs in the front and rear flooring, all mounting brackets, top cowl assembly, and wheel housings.
- » Manufactured using a seven-step metal preparation process, including:
 - A 5 bath dip to totally eliminate rust, dirt and grease.
 - A phosphate and acid rinse step to ensure corrosion resistance and proper adhesion of the primer.
 - New primer formula and application method that is designed for a smooth and even finish.
- » Includes all major factory mounting locations, including channels for body mounting.
- » Dash and shifter tunnels left blank in some applications with varied OE locations.

REBUILT ENTIRELY FROM PARTS LISTED IN THE CATALOG!

Our body panels are more than just parts; they are built with a legacy and heritage in mind. No other supplier can match Omix's passion and dedication to quality. This is why we have been authorized to use the "MOPAR Authentic Restoration" and "MOPAR Official Licensed Product" logos for more than 30 licensed body tubs and panels we produce. We take pride in being one of the few manufacturers strong enough to stand behind the legendary Jeep® name.

Our Body Tub is a completely assembled body shell from the firewall to the tail light panel. Fitted, welded and assembled together with the cowl panel, rear wheel housings, dash panel, and glove box already in place. Or you can upgrade to a Body Tub Kit. It features the same great body tub, [2] front fenders, windshield frame, hood and tailgate. It is the ultimate restoration accessory, primed and shipped to your door.

No more grinding, welding, or cutting out rusty panels, just to struggle as you fight to line up the new part. All the hard work is done for you. Primed and nearly ready for paint. The hardest part will be picking out the new paint color. How quickly can you say Olive Drab?

Of course the body tubs are not completely finished, there will still be some fitting and working to make everything line up. Just the same; as if you were working with a 50 year old body tub. But our tubs are as close as you can get today to a body off the original Toledo assembly line. Why else would MOPAR authorize us to use the "Willys" and "Jeep" scripts on the officially licensed bodies and panels we produce?



[A] 12001.03

| A. Jeep® Body Kits | Part# |
|--|---------------|
| 1941-1942 MB [Before 3/1/42], Body With Fenders, Hood, Windshield & Tailgate | 12001.03 |
| 1942-1943 MB, [After 3/1/42], Body With Fenders, Hood, Windshield & Tailgate | 12001.20 |
| 1944-1945 MB, Body With Fenders, Hood, Windshield & Tailgate | 12001.02 |
| 1941-1945 Ford GPW, Body With Fenders, Hood, Windshield & Tailgate | 12001.04 |
| 1950-1952 M38, Body With Fenders, Hood, Windshield & Tailgate | 12001.05 |
| 1952-1971 M38A1, Body With Fenders, Hood, Windshield & Tailgate | 12001.15 |
| 1945-1949 CJ2A, Body With Fenders, Hood, Windshield & Tailgate | 12001.07 |
| 1945-1949 CJ2A, Willys Stamped, Body With Fenders, Hood W/ Willys Script, Windshield & Tailgate W/ Willys Script | DMC-673859-2A |
| 1948-1953 CJ3A, Body With Fenders, Hood, Windshield & Tailgate | 12001.08 |
| 1948-1953 CJ3A, Willys Stamped, Body With Fenders, Hood W/ Willys Script, Windshield & Tailgate W/ Willys Script | DMC-673859-3A |
| 1953-1967 CJ3B, Body With Fenders, Hood, Windshield & Tailgate | 12001.09 |
| 1953-1967 CJ3B, Willys Stamped, Body With Fenders, Hood W/ Willys Script, Windshield & Tailgate W/ Willys Script | DMC-693197 |
| 1955-1968 CJ5, Body With Fenders, Hood, Windshield & Tailgate | 12001.10 |
| 1969 CJ5, Body With Fenders, Hood, Windshield & Tailgate | 12001.11 |
| 1970-1971 CJ5, Body With Fenders, Hood, Windshield & Tailgate | 12001.12 |
| 1972-1975 CJ5, Body With Fenders, Hood, Windshield & Tailgate | 12001.13 |
| 1955-1968 CJ6, Body With Fenders, Hood, Windshield & Tailgate | 12001.14 |
| 1976-1983 CJ5, Body With Fenders, Hood, Windshield & Tailgate | 12001.16 |
| 1976-1986 CJ7, Body With Fenders, Hood, Windshield & Tailgate | 12001.17 |
| 1981-1986 CJ8 Scrambler, Body With Fenders, Hood, Windshield & Tailgate | 12001.18 |
| 1969-1971 CJ6, Body With Fenders, Hood, Windshield & Tailgate NEW | 12001.19 |

| B. Jeep® Body Tubs | Part# |
|---|---------------|
| 1941-1942 MB [Before 3/1/42] | 12002.02 |
| 1942-1945 MB [After 3/1/42] | 12002.01 |
| 1941-1945 Ford GPW | 12002.03 |
| 1950-1952 M38 | 12002.04 |
| 1945-1949 CJ2A | 12002.06 |
| 1948-1953 CJ3A | 12002.07 |
| 1953-1967 CJ3B | 12002.08 |
| 1955-1969 CJ5 | 12002.09 |
| 1955-1969 CJ5, With Jeep Script Stamped In Cowl Sides | DMC-680637 |
| 1970-1971 CJ5 | 12002.10 |
| 1970-1971 CJ5, With Jeep Script Stamped In Cowl Sides | DMC-680637-VC |
| 1972-1975 CJ5 | 12002.11 |
| 1972-1975 CJ5, With Jeep Script Stamped In Cowl Sides | DMC-680637-VD |
| 1955-1971 CJ6 | 12002.12 |
| 1976-1983 CJ5 | 12002.13 |
| 1976-1983 CJ5, With Jeep Script Stamped In Cowl Sides | DMC-5461335 |
| 1976-1986 CJ7 | 12002.14 |
| 1976-1986 CJ7, With Jeep Script Stamped In Cowl Sides | DMC-5464362 |
| 1981-1986 CJ8 Scrambler | 12002.15 |
| 1987-1995 Wrangler, With Jeep Script Stamped In Cowl Sides NEW | DMC-55050500 |



[B] 12002.06



[B] 12002.14

Body kits, body tubs and body parts are sold "As Is". See Limited Warranty Information inside back cover. Drilling, cutting and other modifications may be required for proper installation. Claims for freight damage must be placed with freight carriers.

Jeep® Licensed Items

Nothing represents a Jeep® more than its very name! It's just not the same unless, well, it says "Jeep"™! The visual appearance of the name stands for a legacy and history that no other vehicle in the world can match. Now you can return your Jeep® to its original markings with these stamped Hoods, Tailgates, Back Panels, Side Panels, Toolbox, Body Tubs, Valve Covers, Grilles and Dash Pads!



MOPAR, JEEP, DODGE, HEMI, PLYMOUTH, RAM, and CHRYSLER vehicles, images and logos are trademarks of Chrysler Group LLC used under license to Omix-Ada®. © Chrysler Group LLC 2011

WILLYS® & JEEP® MARKED ITEMS

| C. Hoods | Part# |
|--|------------|
| 1945-49 CJ2A, 1948-1953 CJ3A, With Willys Script | DMC-670969 |
| 1953-1967 CJ3B, With Willys Script | DMC-681334 |

| D. Grilles | Part# |
|----------------------------------|-------------|
| 1945-46 CJ2A | DMC-663536 |
| 1947-49 CJ2A | DMC-668124 |
| 1948-53 CJ3A | DMC-673149 |
| 1959-67 CJ3B, With Willys Script | DMC-681798 |
| 1955-71 CJ5 | DMC-815385 |
| 1955-71 CJ6 | DMC-815385 |
| 1972-1986 CJ5, CJ6, CJ7, CJ8 | DMC-5752656 |

| E. Jeep® Tailgates | Part# |
|--|-------------|
| 1941-1945 "Willys" Script Rear (Tail) Panel | DMC-2758 |
| 1945-1968 CJ2A, CJ3A, CJ5, Willys Script | DMC-663188 |
| 1969-1983 CJ5 With Jeep® Script | DMC-685459 |
| 1976-1986 CJ7, 1981-1986 CJ8 With Jeep® Script | DMC-5454025 |



[E] DMC-663188



OFFICIAL LICENSED PRODUCT

MOPAR, JEEP, DODGE, HEMI, PLYMOUTH, RAM, and CHRYSLER vehicles, images and logos are trademarks of Chrysler Group LLC used under license to Omix-Ada®. © Chrysler Group LLC 2011

Look for the star to check out all the Mopar Licensed Products



[E] DMC-5454025



[H] DMC-5760458



[I] DMC-6914

| H. Dash Pads | Part# |
|---|-------------|
| 1982-1986 CJ5, CJ7, CJ8, Jeep Script Dashpad, Black, With Moveable Vent Window | DMC-5760458 |
| 1982-1986 CJ5, CJ7, CJ8, Jeep Script Dashpad, Light Gray [Dyeable], With Moveable Vent Window | DMC-5760459 |

| I. Valve Covers | Part# | Price |
|---|----------|-------|
| 1981-1986 CJ5, CJ7, CJ8 and SJ Cherokee 4.2L 6 Cyl Engine, Aluminum Diecast With Jeep Script | DMC-6914 | |
| 1972-1991 CJ5, CJ7, CJ8 and SJ Cherokee AMC V8 304 CI, 360 CI, 390 CI Engine, Aluminum Diecast With Jeep Script | DMC-6920 | |



[G] DMC-5451627



[G] DMC-5457017



[G] DMC-5455179



[F] DMC-8133339



[D] DMC-5752656

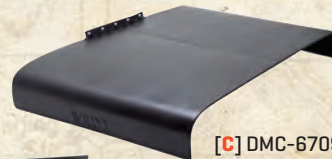

[C] DMC-670969



[F] DMC-3227K

| F. Jeep® Body Panels | Part# |
|---|-------------|
| 1945-1949 CJ2A, Windshield Frame With Willys Script | DMC-663628 |
| 1945-1975 CJ2A, CJ3A, CJ3B, CJ5, CJ6, Toolbox With Jeep® Script | DMC-3227K |
| 1976-1983 CJ5, Side Panel With Jeep® Script, Left NEW | DMC-8133112 |
| 1976-1983 CJ5, Side Panel With Jeep Script, Right NEW | DMC-8133337 |
| 1976-1986 CJ7, 1987-1995 Wrangler, Side Panel With Jeep® Script, Left NEW | DMC-8133339 |
| 1976-1986 CJ7, 1987-1995 Wrangler, Side Panel With Jeep® Script, Right NEW | DMC-8133338 |

| G. Exterior Emblems | Part# |
|---|-------------|
| 1976-1990 All Jeeps®, Jeep® AMC Flag Emblem, Self Adhesive NEW | DMC-5451627 |
| 1972-1983 CJ5, CJ5 Emblem, Self Adhesive NEW | DMC-5455179 |
| 1976-1986 CJ7, CJ7 Emblem, Self Adhesive NEW | DMC-5457017 |
| 1981-1986 CJ8, CJ8 Emblem, Self Adhesive NEW | DMC-5758601 |
| 1981-1986 CJ8, Scrambler Emblem, Self Adhesive NEW | DMC-5763509 |

Body kits, body tubs and body parts are sold "As Is". See Limited Warranty Information inside back cover. Drilling, cutting and other modifications may be required for proper installation. Claims for freight damage must be placed with freight carriers. All images are subject to be representative. More detailed information is available online.

[G] 12407.02



[E] 12420.03



[A] 12402.11



OMIX-ADA, Inc.

[D] 12021.49



[D] 12021.80



[F] 12419.19



[D] 12421.02



[B] 12409.03



[F] 12419.08



[C] 12409.05

**A. Headlight Assemblies**

| Part# | Part# |
|---|----------|
| 2007-2012 Wrangler, Left NEW | 12402.21 |
| 2007-2012 Wrangler, Right NEW | 12402.20 |
| 1993-1998 Grand Cherokee, Left | 12402.07 |
| 1993-1998 Grand Cherokee, Right | 12402.06 |
| 1999-2004 Grand Cherokee Laredo, Left | 12402.09 |
| 1999-2004 Grand Cherokee Laredo, Right | 12402.08 |
| 1999-2004 Grand Cherokee Limited, Left | 12402.11 |
| 1999-2004 Grand Cherokee Limited, Right | 12402.10 |
| 2005-2007 Grand Cherokee, Left | 12402.19 |
| 2005-2007 Grand Cherokee, Right | 12402.18 |
| 2008-2010 Grand Cherokee, w/o HID, Left NEW | 12402.23 |
| 2008-2010 Grand Cherokee, w/o HID, Right NEW | 12402.22 |
| 2002 Liberty (Before 11/5/02), Left | 12402.13 |
| 2002 Liberty (Before 11/5/02), Right | 12402.12 |
| 2002-2004 Liberty (After 11/6/02), Left | 12402.15 |
| 2002-2004 Liberty (After 11/6/02), Right | 12402.14 |
| 2005-2007 Liberty, Left | 12402.17 |
| 2005-2007 Liberty, Right | 12402.16 |
| 2008-2010 Liberty, Without Fog Lights, Left NEW | 12402.24 |
| 2008-2010 Liberty, Without Fog Lights, Right NEW | 12402.25 |

B. Round Sealed Beam Headlight Bulbs

| Part# | Part# |
|------------------------------------|----------|
| 1941-1945 MB, GPW, Sealed Beam, 6v | 12409.03 |
| 1945-1964 CJ, Sealed, 6v | 12409.02 |
| 1965-1986 CJ, Sealed, 12v | 12409.01 |
| 1965-1986 CJ, Halogen | 12409.04 |
| 1997-2006 Wrangler | 12409.04 |

C. Rectangular Sealed Beam Headlight Bulbs

| Part# | Part# |
|--------------------|----------|
| 1987-1995 Wrangler | 12409.05 |
| 1984-2001 Cherokee | 12409.05 |

D. Headlight Housings

| Part# | Part# |
|---|----------|
| 1941-1945 MB & Ford GPW | 12402.05 |
| 1941-1945 MB & Ford GPW, Headlight Housing Bracket, Right | 12021.50 |
| 1941-1945 MB & Ford GPW, Headlight Housing Bracket, Left | 12021.51 |
| 1941-1945 MB & Ford GPW, Blackout Light Housing, Fender Mounted, LH or RH | 12021.80 |
| 1941-1945 MB & Ford GPW, Blackout Light Bracket, LH or RH | 12021.49 |
| 1950-1952 M38, Headlight Brush Guard, LH or RH | 12023.21 |
| 1950-1952 M38, Blackout Light Bracket, LH or RH | 12023.23 |
| 1972-1986 CJ (Does One Side) With Bulb, LH or RH | 12402.01 |
| 1972-1986 CJ (Pair) With Bulb | 12402.02 |
| 1987-1995 Wrangler, Right | 12421.02 |
| 1987-1995 Wrangler, Left | 12421.01 |
| 1997-2006 Wrangler, With Bulb, Right | 12402.04 |
| 1997-2006 Wrangler, With Bulb, Left | 12402.03 |
| 1984-2001 Cherokee, Right | 12421.02 |
| 1984-2001 Cherokee, Left | 12421.01 |

E. Headlight Retaining Rings

| Part# | Part# |
|--------------------|----------|
| 1972-1986 CJ | 12420.01 |
| 1987-1995 Wrangler | 12420.03 |
| 1997-2006 Wrangler | 12420.02 |
| 1984-2001 Cherokee | 12420.03 |

F. Headlight Bezels

| Part# | Part# |
|--|----------|
| 1945-1949 CJ2A, Chrome (Each) | 12419.01 |
| 1948-1953 CJ3A, Chrome (Each) | 12419.01 |
| 1953-1967 CJ3B, Chrome (Each) | 12419.02 |
| 1955-1971 CJ5, Chrome (Each) | 12419.02 |
| 1955-1971 CJ6, Chrome (Each) | 12419.02 |
| 1972-1986 CJ, Chrome (Each) | 12419.03 |
| 1972-1986 CJ, Chrome (Pair) | 12419.04 |
| 1987-1995 Wrangler, Black (Pair) | 12419.24 |
| 1987-1995 Wrangler, Chrome, (Pair) | 12419.05 |
| 1987-1995 Wrangler, Chrome, Left | 12419.21 |
| 1987-1995 Wrangler, Chrome, Right | 12419.22 |
| 1997-2006 Wrangler, Black (Pair) | 12419.23 |
| 1997-2006 Wrangler, Pair, Chrome | 12419.08 |
| 1997-2006 Wrangler, Chrome, Left | 12419.07 |
| 1997-2006 Wrangler, Chrome, Right | 12419.06 |
| 1984-1990 Cherokee, Gray, Left | 12419.09 |
| 1984-1990 Cherokee, Gray, Right | 12419.10 |
| 1984-1990 Cherokee, Chrome, Left | 12419.11 |
| 1984-1990 Cherokee, Chrome, Right | 12419.12 |
| 1991-1996 Cherokee, Flat Black / Chrome, Left | 12419.13 |
| 1991-1996 Cherokee, Flat Black / Chrome, Right | 12419.14 |
| 1991-1996 Cherokee, Black, Left | 12419.15 |
| 1991-1996 Cherokee, Black, Right | 12419.16 |
| 1997-2001 Cherokee, Black, Left | 12419.17 |
| 1997-2001 Cherokee, Black, Right | 12419.18 |
| 1997-2001 Cherokee, Neutral (Paintable), Left | 12419.19 |
| 1997-2001 Cherokee, Neutral (Paintable), Right | 12419.20 |

G. Fog Lights

| Part# | Part# |
|---|----------|
| 2007-2010 Wrangler, LH or RH NEW | 12407.12 |
| 1997-2001 Cherokee, Left | 12407.01 |
| 1997-2001 Cherokee, Right | 12407.02 |
| 1993-1995 Grand Cherokee, RH or LH | 12407.09 |
| 1996 Grand Cherokee, Left NEW | 12407.13 |
| 1996 Grand Cherokee, Right NEW | 12407.14 |
| 1997-1998 Grand Cherokee, Left | 12407.05 |
| 1997-1998 Grand Cherokee, Right | 12407.06 |
| 1999-2003 Grand Cherokee, Left | 12407.03 |
| 1999-2003 Grand Cherokee, Right | 12407.04 |
| 2004 Grand Cherokee, LH or RH NEW | 12407.15 |
| 2005-2010 Grand Cherokee, LH or RH | 12407.11 |
| 2002-2004 Liberty, Left | 12407.07 |
| 2002-2004 Liberty, Right | 12407.08 |
| 2005-2007 Liberty (Except Renegade), LH or RH | 12407.10 |

Lighting



H. Parking & Turn Signal Lights Part#

| | |
|---|----------|
| 1955-1971 CJ, Assembly With Amber Lens, LH or RH | 12405.01 |
| 1955-1971 CJ, Lens, Amber, LH or RH | 12405.03 |
| 1955-1971 CJ, Assembly With Clear Lens, LH or RH | 12405.02 |
| 1955-1971 CJ, Lens, Clear, LH or RH | 12405.04 |
| 1976-1986 CJ, Assembly With Clear Lens, LH or RH | 12405.06 |
| 1976-1986 CJ, Lens, Clear, LH or RH | 12405.08 |
| 1976-1986 CJ, Assembly With Amber Lens [OE for Export Models], LH or RH | 12405.07 |
| 1976-1986 CJ, Lens, Amber [OE for Export Models], LH or RH | 12405.09 |
| 1987-1993 Wrangler, LH or RH | 12405.10 |
| 1997-2006 Wrangler, LH or RH | 12405.11 |
| 2007-2012 Wrangler, Left NEW | 12405.25 |
| 2007-2012 Wrangler, Right NEW | 12405.24 |
| 1984-1996 Cherokee, Left | 12405.13 |
| 1984-1996 Cherokee, Right | 12405.12 |
| 1997-2001 Cherokee, Left | 12405.15 |
| 1997-2001 Cherokee, Right | 12405.14 |
| 1993-1998 Grand Cherokee, Parking Light, Left | 12405.17 |
| 1993-1998 Grand Cherokee, Parking Light, Right | 12405.16 |
| 1993-1998 Grand Cherokee, Turn Signal, Clear, Left | 12401.13 |
| 1993-1998 Grand Cherokee, Turn Signal, Clear, Right | 12401.14 |
| 1993-1998 Grand Cherokee [Export Models], Turn Signal, Amber, Left | 12401.15 |
| 1993-1998 Grand Cherokee [Export Models], Turn Signal, Amber, Right | 12401.16 |
| 2002-2004 Liberty, Left | 12401.17 |
| 2002-2004 Liberty, Right | 12401.18 |
| 2005-2007 Liberty, Right | 12401.22 |
| 2005-2007 Liberty, Left | 12401.23 |
| 2008-2010 Liberty, Left NEW | 12405.27 |
| 2008-2010 Liberty, Right NEW | 12405.26 |

I. Side Marker Lights Part#

| | |
|---|----------|
| 1972-1986 CJ, Assembly [Includes Lens, Bulb and Wiring Pigtail], Amber, Front, LH or RH | 12401.02 |
| 1972-1986 CJ, Lens, Amber, Front, LH or RH | 12401.01 |
| 1972-1986 CJ, Assembly [Includes Lens, Bulb and Wiring Pigtail], Red, Rear, LH or RH | 12401.04 |
| 1976-1986 CJ, Lens, Red, Rear, LH or RH | 12401.03 |
| 1972-1986 CJ, Wiring Pigtail, Front or Rear, LH or RH | 12401.05 |
| 1987-1995 Wrangler, LH or RH | 12401.06 |
| 1997-2006 Wrangler, Left | 12401.07 |
| 1997-2006 Wrangler, Right | 12401.08 |
| 2007-2012 Wrangler, Left NEW | 12401.25 |
| 2007-2012 Wrangler, Right NEW | 12401.24 |
| 1984-1996 Cherokee, Left | 12401.09 |
| 1984-1996 Cherokee, Right | 12401.10 |
| 1997-2001 Cherokee, Left | 12401.11 |
| 1997-2001 Cherokee, Right | 12401.12 |
| 2005-2007 Liberty, Left | 12401.21 |
| 2005-2007 Liberty, Right | 12401.20 |
| 2008-2010 Liberty, Left NEW | 12402.23 |
| 2008-2010 Liberty, Right NEW | 12402.22 |

J. Back-Up Lights Part#

| | |
|---|----------|
| 1945-1975 CJ, Assembly [Includes Lens, Bulb and Wiring Pigtail], LH or RH | 12406.01 |
| 1946-1975 CJ, Lens, LH or RH | 12405.04 |

K. Tail Lights Part#

| | |
|--|----------|
| 1941-1945 MB and Ford GPW, Assembly, Left | 12403.51 |
| 1941-1945 MB and Ford GPW, Assembly, Right | 12403.52 |
| 1941-1945 MB and Ford GPW, Housing, LH or RH | 12403.50 |
| 1945-1975 CJ, Left | 12403.01 |
| 1945-1975 CJ, Right | 12403.02 |
| 1976-1980 CJ, With Black Housing, Left | 12403.03 |
| 1976-1980 CJ, With Black Housing, Right | 12403.04 |
| 1976-1980 CJ, With Chrome Housing, Left | 12403.05 |
| 1976-1980 CJ, With Chrome Housing, Right | 12403.06 |
| 1981-1986 CJ, With Black Housing, Left | 12403.07 |
| 1981-1986 CJ, With Black Housing, Right | 12403.08 |
| 1981-1986 CJ, With Chrome Housing, Left | 12403.09 |
| 1981-1986 CJ, With Chrome Housing, Right | 12403.10 |
| 1976-1986 CJ, Lens, LH or RH | 12404.01 |
| 1991-1997 Wrangler, With Black Housing, Left | 12403.13 |
| 1991-1997 Wrangler, With Black Housing, Right | 12403.14 |
| 1991-1997 Wrangler, With Chrome Housing, Left | 12403.15 |
| 1991-1997 Wrangler, With Chrome Housing, Right | 12403.16 |
| 1987-2006 Wrangler, Lens, LH or RH | 12404.01 |
| 2007-2012 Wrangler, Left NEW | 12403.37 |
| 2007-2012 Wrangler, Right NEW | 12403.36 |
| 1984-1996 Cherokee, Left | 12403.17 |
| 1984-1996 Cherokee, Right | 12403.18 |
| 1997-2001 Cherokee, Left | 12403.19 |
| 1997-2001 Cherokee, Right | 12403.20 |
| 1993-1998 Grand Cherokee, Left | 12403.21 |
| 1993-1998 Grand Cherokee, Right | 12403.22 |
| 1999-2004 Grand Cherokee, Left | 12403.23 |
| 1999-2004 Grand Cherokee, Right | 12403.24 |
| 2005-2006 Grand Cherokee, Left | 12403.33 |
| 2005-2006 Grand Cherokee, Right | 12403.32 |
| 2007-2010 Grand Cherokee, Left | 12403.35 |
| 2007-2010 Grand Cherokee, Right | 12403.34 |
| 2002-2004 Liberty, Left | 12403.25 |
| 2002-2004 Liberty, Right | 12403.26 |
| 2005-2007 Liberty, Without Air Dam, Left NEW | 12403.29 |
| 2005-2007 Liberty, Without Air Dam, Right NEW | 12403.28 |
| 2005-2007 Liberty, With Air Dam, Left NEW | 12403.31 |
| 2005-2007 Liberty, With Air Dam, Right NEW | 12403.30 |
| 2008-2010 Liberty, Left NEW | 12403.39 |
| 2008-2010 Liberty, Right NEW | 12403.38 |

L. Headlight Hardware Part#

| | |
|---|----------|
| 1972-1986 CJ, Headlight Adjusting Screw | 12410.01 |
|---|----------|

M. Replacement Bulbs Part#

| | |
|--|----------|
| 1972-1986 CJ, Front Parking Light Bulb, Amber, LH or RH | 12408.01 |
| 1972-1986 CJ, Side Marker Light Bulb, Clear, LH or RH | 12408.06 |
| 1976-1986 CJ, Back Up Light Bulb, Clear, LH or RH | 12408.04 |
| 1976-1986 CJ, Tail Light Bulb, Multi Function, Clear, LH or RH | 12408.05 |
| 1987-1993 Wrangler, Front Parking Light Bulb, Amber, LH or RH | 12408.02 |
| 1987-1993 Wrangler, Side Marker Light Bulb, Clear, LH or RH | 12408.06 |
| 1987-2006 Wrangler, Tail Light Bulb, Multi Function, Clear, LH or RH | 12408.04 |
| 1994-2006 Wrangler, Front Parking Light Bulb, Amber, LH or RH | 12408.03 |
| 1987-2006 Wrangler, Tail Light Bulb, Multi Function, Clear, LH or RH | 12408.05 |
| 1984-2001 Cherokee, 1997-2006 Wrangler, Interior Courtesy Light Bulb | 12408.07 |
| 2003-2006 Wrangler, Dome Light Bulb | 12408.08 |

All images are subject to be representative. More detailed information is available online.



A. Windshield Glass Seals

Part#

| | |
|--|----------|
| 1941-1945 MB and Ford GPW, 1945-1949 CJ2A, Windshield Weatherstrip, Inner to Outer Frame [1 Required] | 12301.01 |
| 1941-1945 MB and Ford GPW, 1945-1949 CJ2A, Windshield Glass Seal, Seals Glass to Inner Frame [2 Required] | 12301.02 |
| 1948-1953 CJ3A, 1950-1952 M38, 1953-1967 CJ3B, 1955-1975 CJ5 & CJ6, 1952-1971 M38A1, Windshield Weatherstrip | 12301.03 |
| 1976-1983 CJ5, 1976-1986 CJ7, 1981-1986 CJ8, Windshield Weatherstrip | 12301.04 |
| 1987-1995 Wrangler, Windshield Weatherstrip, Inner Glass Seal | 12301.05 |
| 1997-2006 Wrangler, 2004-2006 Wrangler Unlimited, Windshield Weatherstrip, Inner | 12301.09 |
| 1987-1995 Wrangler, Windshield Weatherstrip, Outer Glass Seal | 12301.06 |
| 1997-2006 Wrangler, 2004-2006 Wrangler Unlimited, Windshield Weatherstrip, Outer | 12301.08 |

B. Windshield Glass Hardware

Part#

| | |
|--|----------|
| 1987-95 Wrangler, Windshield Glass Seal Clip | 12301.07 |
|--|----------|

C. Cowl Rubber Seals

Part#

| | |
|--|----------|
| 1941-1945 MB, 1941-1945 Ford GPW, 1945-1949 CJ2A, 1948-1953 CJ3A, 1950-1952 M38, 1953-1967 CJ3B, Windshield to Cowl Weatherstrip | 12302.01 |
| 1955-1975 CJ5 & CJ6, 1952-1971 M38A1, Windshield to Cowl Weatherstrip | 12302.02 |
| 1976-1983 CJ5, 1976-1986 CJ7, 1981-1986 CJ8, Cowl Seal | 12302.03 |
| 1987-1995 Wrangler, Cowl Seal | 12302.04 |
| 1997-2002 Wrangler, Cowl Seal | 12302.05 |

D. Door Seals

Part#

| | |
|---|----------|
| 1976-1986 CJ7, 1981-1986 CJ8, 1987-1995 Wrangler, Door Seal [For Full Steel Doors], Right | 12303.02 |
| 1976-1986 CJ7, 1981-1986 CJ8, 1987-1995 Wrangler, Door Seal [For Full Steel Doors], Left | 12303.01 |
| 1997-2006 Wrangler, 2004-2006 Wrangler Unlimited, Door Seal [For Full Steel Doors], Right | 12303.12 |
| 1997-2006 Wrangler, 2004-2006 Wrangler Unlimited, Door Seal [For Full Steel Doors], Left | 12303.13 |
| 1987-1995 Wrangler Half Door Weather Seal [RH] | 12303.04 |
| 1987-1995 Wrangler Half Door Weather Seal [LH] | 12303.03 |
| 1997-2006 Wrangler RH, Half Door, Outer Seal | 12303.14 |
| 1997-2006 Wrangler LH, Half Door, Outer Seal | 12303.15 |

E. Door Seal Kits (Includes: D, F, G, H, I)

Part#

| | |
|--|----------|
| 1982-1983 CJ5, 1982-1986 CJ7, 1982-1986 CJ8, 1987-1995 Wrangler, Door Seal Kit, With Hardtop & Moveable Vent Windows, Left [5 Piece Kit] NEW | 12303.51 |
| 1976-1983 CJ5, 1976-1986 CJ7, 1981-1986 CJ8, 1987-1995 Wrangler, Door Seal Kit, With Hardtop & Moveable Vent Windows, Right [5 Piece Kit] NEW | 12303.50 |
| 1976-1981 CJ5, 1976-1981 CJ7, 1981 CJ8, Door Seal Kit, With Hardtop & Fixed Vent Windows, Left [5 Piece Kit] NEW | 12303.53 |
| 1976-1981 CJ5, 1976-1981 CJ7, 1981 CJ8, Door Seal Kit, With Hardtop & Fixed Vent Windows, Right [5 Piece Kit] NEW | 12303.52 |

F. Door Window Seals

Part#

| | |
|--|----------|
| 1976-1986 CJ, Door Window Rear Seal, LH=RH | 12303.05 |
| 1987-1995 Wrangler, Door Window Rear Seal, LH=RH | 12303.05 |

G. Door Glass Outer Seals

Part#

| | |
|---|----------|
| 1976-1986 CJ, Door Glass Outer Seal, RH | 12303.06 |
| 1976-1986 CJ, Door Glass Outer Seal, LH | 12303.07 |
| 1987-1995 Wrangler, Door Glass Outer Seal, RH | 12303.06 |
| 1987-1995 Wrangler, Door Glass Outer Seal, LH | 12303.07 |

H. Door Glass Inner Seals

Part#

| | |
|---|----------|
| 1976-1986 CJ, Door Glass Outer Seal, RH | 12303.08 |
| 1976-1986 CJ, Door Glass Outer Seal, LH | 12303.09 |
| 1987-1995 Wrangler, Door Glass Outer Seal, RH | 12303.08 |
| 1987-1995 Wrangler, Door Glass Outer Seal, LH | 12303.09 |

I. Door Glass Edge Seals

Part#

| | |
|---|----------|
| 1982-1986 CJ, Door Edge Seal w/ Moveable Vent Window, LH=RH | 12303.10 |
| 1987-1995 Wrangler, Door Edge Seal With Moveable Vent Window, LH=RH | 12303.10 |
| 1978-1981 CJ, Door Glass Edge Seal With Stationary Vent Window | 12303.11 |



| J. Hardtop, Tailgate & Liftgate Seals & Components | | Part# |
|--|--|----------|
| 1 | 1977-1986 CJ7 Liftgate Outer Seal With Plastic Locks | 12304.01 |
| | 1987-1995 Wrangler, Weatherstrip, Rear Lift-Gate Glass | 12304.08 |
| 2 | 1977-1986 CJ7 Liftgate Inner Glass Seal | 12304.02 |
| 3 | 1976-1986 CJ Hardtop Rear Side Window Seal, RH=LH | 12304.03 |
| 4 | 1977-1986 Hardtop To Windshield Frame Seal | 12304.04 |
| 4 | 1987-1995 Hardtop To Windshield Frame Seal | 12304.04 |
| 5 | 1977-1986 CJ Hardtop Liftgate Hinge | 11901.01 |
| 6 | 1977-1986 CJ Hardtop T-Handle | 11901.02 |
| 7 | 1976-1986 CJ7 & CJ8 Tailgate Seal | 12305.01 |
| 7 | 1987-1995 Wrangler Tailgate Seal | 12305.02 |
| 7 | 1997-2006 Wrangler Lower Tailgate Seal | 12305.03 |
| | 1987-1995 Wrangler Tailgate's Upper Weatherstrip [Between Liftgate & Tailgate] | 12304.09 |
| 8 | 1987-1995 Wrangler Corner Hardtop Seal, RH | 12304.06 |
| 8 | 1987-1995 Wrangler Corner Hardtop Seal, LH | 12304.05 |
| 9 | 1977-1986 Hardtop Seal Kit, CJ | 12304.07 |
| 9 | 1987-1995 Hardtop Seal Kit, Wrangler | 12304.07 |
| 10 | 1977-1986 Cam & Cable, CJ7 Hardtop | 11901.03 |
| 11 | 1977-1986 Latch Assembly, CJ7 Hardtop, Each | 11901.04 |
| | 1987-1995 Wrangler Hardtop Fastener Kit | 12215.11 |

| K. Soft Top Seals | | Part# |
|-------------------|---|----------|
| | 1987-1995 Wrangler With Factory Soft Top, Plastic Door Seal, RH | 12306.04 |
| | 1987-1995 Wrangler With Factory Soft Top, Plastic Door Seal, LH | 12306.03 |

| L. Soft Top Seal Hardware | | Part# |
|---------------------------|--|----------|
| | 1987-1995 Wrangler With Factory Soft Top, Door Seal Clip | 12306.08 |
| | 1987-1995 Wrangler Replacement Soft Top Snaps | 12306.07 |

All images are subject to be representative. More detailed information is available online.



Look for the star to check out all the Mopar Licensed Products



OFFICIAL LICENSED PRODUCT

MOPAR, JEEP, DODGE, HEMI, PLYMOUTH, RAM, and CHRYSLER vehicles, images and logos are trademarks of Chrysler Group LLC used under license to Omix-Ada™. © Chrysler Group LLC 2011



| A. Steel Body Kits | Part# |
|--|----------|
| 1941-1942 MB [Before 3/1/42], Body With Fenders, Hood, Windshield & Tailgate | 12001.03 |
| 1942-1943 MB, [After 3/1/42], Body With Fenders, Hood, Windshield & Tailgate | 12001.20 |
| 1944-1945 MB, Body With Fenders, Hood, Windshield & Tailgate | 12001.02 |
| 1941-1945 Ford GPW, Body With Fenders, Hood, Windshield & Tailgate | 12001.04 |
| Mini MB, For Use with ATV, UTV, Go Kart, Riding Lawn Mower Chassis. With Fenders, Hood, Top Bow, Windshield & Tailgate | 12001.01 |
| B. Steel Body Tubs | Part# |
| 1941-1942 MB [Before 3/1/42] | 12002.02 |
| 1942-1945 MB [After 3/1/42] | 12002.01 |
| 1941-1945 Ford GPW | 12002.03 |
| C. Body Mounting Hardware | Part# |
| 1941-1945 MB and Ford GPW, Body Mounting Kit, To Mount Body To Frame, Includes Washers, Rubber Spacers, and Bolts | 12201.01 |
| D. Hood & Components | Part# |
| 1941-1945 MB and Ford GPW, Hood | 12003.01 |
| 1941-1945 MB and Ford GPW, Hood Hinge, [1 Required] | 12021.01 |
| 1941-1945 MB and Ford GPW, Hood Catch Assembly, Primered, LH or RH | 12021.83 |
| 1941-1945 MB and Ford GPW, Hood Catch Assembly, Black Powdercoat, LH or RH | 11210.04 |
| 1941-1945 MB and Ford GPW, Hood Catch Bracket, LH or RH | 12021.77 |
| E. Fenders & Components | Part# |
| 1941-1945 MB and Ford GPW, Fender, Left | 12004.01 |
| 1941-1945 MB and Ford GPW, Fender, Right | 12004.02 |
| 1941-1945 MB and Ford GPW, Fender Brace, Left | 12021.03 |
| 1941-1945 MB and Ford GPW, Fender Brace, Right | 12021.02 |

| F. Body Panels | Part# |
|--|----------|
| 1941-1945 MB and Ford GPW, Grille, Stamped, 9 Slats NEW | 12021.99 |
| 1941-1945 MB and Ford GPW, Side [Quarter] Panel, With Axe Sheath, Left | 12009.01 |
| 1941-1945 MB and Ford GPW, Side [Quarter] Panel, Right | 12009.02 |
| 1941-1945 MB and Ford GPW, Cowl Side Panel, With Step, Left | 12010.01 |
| 1941-1945 MB and Ford GPW, Cowl Side Panel, With Step, Right | 12010.02 |
| 1941-1945 MB and Ford GPW, Cowl Side Step, Left | 12021.15 |
| 1941-1945 MB and Ford GPW, Cowl Side Step, Right | 12021.16 |
| 1941-1942 MB and Ford GPW, Gas Tank Well [Cover] | 12021.21 |
| 1943-1945 MB and Ford GPW, Gas Tank Well [Cover] | 12021.22 |

| G. Tail Panels | Part# |
|---|----------|
| 1941-1945 MB, "Willys" Script Rear [Tail] Panel | DMC-2758 |
| 1941-1945 MB and Ford GPW, Rear [Tail] Panel | 12005.01 |

| H. Floor Panel | Part# |
|---|----------|
| 1941-1945 MB and Ford GPW, Floor Pan, Front, One Piece | 12007.01 |
| 1941-1945 MB and Ford GPW, Floor Pan, Rear, One Piece | 12008.01 |
| 1941-1945 MB and Ford GPW, Floor Access Cover for Brake Master Cylinder | 12021.60 |
| 1941-1945 MB, Front Frame Rail Section [18.5"], Left | 12021.31 |
| 1941-1945 MB, Front Frame Rail Section [18.5"], Right | 12021.32 |
| 1941-1945 MB, Front Frame Rail Section [49"], Left | 12021.91 |
| 1941-1945 MB, Front Frame Rail Section [49"], Right | 12021.92 |
| 1941-1945 MB and Ford GPW, Rear Floor Bracket, Inner | 12021.55 |
| 1941-1945 MB and Ford GPW, Rear Floor Bracket, Outer | 12021.56 |
| 1941-1945 MB and Ford GPW, Frame to Crossmember V Bracket | 12021.64 |
| 1941-1945 MB and Ford GPW, Transmission & Transfer Case Crossmember | 12021.23 |

| I. Windshield Frame & Components | Part# |
|---|----------|
| 1941-1943 MB and Ford GPW, Windshield Frame Assembly, Includes Inner and Outer Frame | 12006.01 |
| 1941-1943 MB and Ford GPW, Inner Windshield Frame | 12021.07 |
| 1941-1943 MB and Ford GPW, Windshield Adjusting Arm, LH or RH [2 Required] Allows Inner Windshield Frame to Tilt. | 12021.05 |
| 1941-1943 MB and Ford GPW, Windshield Adjusting Knob [2 Required] | 12021.06 |
| 1941-1945 MB and Ford GPW, Windshield to Cowl Bracket | 12021.09 |
| 1941-1943 MB and Ford GPW, Windshield Interior Latch, LH or RH [2 Required] | 12021.04 |
| 1941-1945 MB and Ford GPW, Windshield Catch Assembly [Vertical Mount], Primered, LH or RH | 12021.84 |
| 1941-1945 MB and Ford GPW, Windshield Catch Assembly [Vertical Mount], Black, LH or RH | 11210.05 |
| 1941-1945 MB and Ford GPW, Windshield Catch Bracket, LH or RH | 12021.10 |
| 1941-1945 MB and Ford GPW, Windshield Hood Rest, Wooden | 12021.08 |



| J. Bumpers & Components | Part# |
|--|----------|
| 1941-1945 MB and Ford GPW, Front Bumper | 12021.26 |
| 1941-1945 MB, Front Bumper Wood Filler | 12021.69 |
| 1941-1945 Ford GPW, Front Bumper Wood Filler | 12021.70 |
| 1941-1945 Ford GPW, Front Bumper Gusset, Lower, Left | 12021.29 |
| 1941-1945 Ford GPW, Front Bumper Gusset, Lower, Right | 12021.30 |
| 1941-1945 Ford GPW, Front Bumper Gusset, Upper, Left | 12021.27 |
| 1941-1945 Ford GPW, Front Bumper Gusset, Upper, Right | 12021.28 |
| 1941-1945 MB and Ford GPW, Rear Bumper (Crossmember) | 12021.24 |
| 1941-1945 MB and Ford GPW, Front Bumperette (2 Required) | 12021.25 |
| 1941-1945 MB and Ford GPW, Windshield Hood Rest, Wooden | 12021.08 |

| K1. Body Accessories Mirrors | Part# |
|---|----------|
| 1941-1945 MB and Ford GPW, Round Mirrors, Black, Pair | 11001.01 |
| 1941-1945 MB and Ford GPW, Side Mirror Arm | 11001.10 |

| K2. Body Accessories Handles & Mounts | Part# |
|--|----------|
| 1941-1945 MB and Ford GPW, Footman Loop | 12021.43 |
| 1941-1945 MB and Ford GPW, Side Body Lift Handle (2 Required) | 12021.48 |
| 1941-1945 MB and Ford GPW, Rear Body Lift Handle (Mounts on Rear Corners) (2 Required) | 12021.47 |
| 1941-1945 MB and Ford GPW, Axe Sheath | 12021.41 |
| 1941-1945 MB and Ford GPW, Axe Clamp, Front | 12021.39 |
| 1941-1945 MB and Ford GPW, Axe Clamp, Rear | 12021.40 |
| 1941-1945 MB and Ford GPW, Jerry Can Carrier | 12021.62 |
| 1941-1945 MB and Ford GPW, Jerry Can Strap Bracket | 12021.79 |
| 1941-1945 MB and Ford GPW, Shovel Mounting Bracket | 12021.42 |
| 1941-1945 MB and Ford GPW, Oil Can Mounting Bracket | 12021.63 |
| 1941-1945 MB and Ford GPW, Machine Gun Mounting Plate | 12021.54 |
| 1941-1945 MB and Ford GPW, Pintle Hook | 11550.01 |

| K3. Body Accessories Battery Tray | Part# |
|--|----------|
| 1941-1945 Ford GPW, Battery Tray | 12021.61 |
| 1941-1945 MB and Ford GPW, Battery Tray Hold Down | 12021.85 |
| 1941-1945 MB and Ford GPW, Battery Tray Hold Down Strap | 12021.93 |
| 1941-1945 MB and Ford GPW, Battery Tray Hold Down J-Bolt | 12021.82 |

| L. Top Frame | Part# |
|---|----------|
| 1941-1945 MB and Ford GPW, Convertible Top Frame (Bow) Assembly | 12021.33 |
| 1941-1945 MB and Ford GPW, Top Bow Pivot Bracket (2 Required) | 12021.34 |
| 1941-1945 MB and Ford GPW, Top Bow Side Pivot (2 Required) | 12021.35 |
| 1941-1945 MB and Ford GPW, Top Bow Front Pivot, Right | 12021.36 |
| 1941-1945 MB and Ford GPW, Top Bow Front Pivot, Left | 12021.37 |

| M. Interior | Part# |
|--|----------|
| 1941-1945 MB and Ford GPW, Rear View Mirror | 11020.01 |
| 1941-1945 MB, Driver's Footrest | 12021.57 |
| 1941-1945 Ford GPW, Driver's Footrest | 12021.81 |
| 1941-1945 MB and Ford GPW, Glove Box Door | 12021.46 |
| 1941-1945 MB, Tool Box Lid | 12021.44 |
| 1941-1945 Ford GPW, Tool Box Lid | 12021.45 |
| 1941-1945 MB and Ford GPW, Tool Box Lock Set | 12021.76 |
| 1941-1945 MB and Ford GPW, Seat Frame, Front, Left | 12011.01 |
| 1941-1945 MB and Ford GPW, Seat Frame, Front, Right | 12011.02 |
| 1941-1945 MB, Seat Frame, Rear | 12011.03 |
| 1941-1945 Ford GPW, Seat Frame, Rear | 12011.15 |
| 1941-1945 MB and Ford GPW, Rear Seat Pivot Bracket | 12021.18 |
| 1941-1945 MB and Ford GPW, Rear Seat Pivot Retainer | 12021.19 |
| 1941-1945 MB and Ford GPW, Rear Seat Hook | 12021.20 |
| 1941-1945 MB and Ford GPW, Rear Seat to Wheelhouse Support | 12021.17 |
| 1941-1945 MB and Ford GPW, 60" Seat Belt (Lap Belt), Black | 13202.04 |
| 1941-1945 MB and Ford GPW, 60" Seat Belt (Lap Belt), Tan NEW | 13202.20 |
| 1941-1945 MB and Ford GPW, 60" Seat Belt (Lap Belt), Gray NEW | 13202.30 |
| 1941-1945 MB and Ford GPW, 60" Seat Belt (Lap Belt), Olive Drab NEW | 13202.40 |
| 1941-1945 MB and Ford GPW, 60" Seat Belt Retractable (Lap Belt), Black | 13202.02 |
| 1941-1945 MB and Ford GPW, 60" Seat Belt Retractable (Lap Belt), Tan NEW | 13202.21 |
| 1941-1945 MB and Ford GPW, 60" Seat Belt Retractable (Lap Belt), Gray NEW | 13202.31 |
| 1941-1945 MB and Ford GPW, 60" Seat Belt Retractable (Lap Belt), Olive Drab NEW | 13202.41 |

| N. Weatherstrip & Felt | Part# |
|---|----------|
| 1941-1945 MB and Ford GPW, Windshield Weatherstrip, Inner to Outer Frame (1 Required) | 12301.01 |
| 1941-1945 MB and Ford GPW, Windshield Glass Seal, Seals Glass to Inner Frame (2 Required) | 12301.02 |
| 1941-1945 MB and Ford GPW, Cowl Seal | 12302.01 |
| 1941-1945 MB and Ford GPW, Gas Tank Felt Kit | 12021.87 |
| 1941-1945 MB and Ford GPW, Tool Box Lid Felt Kit | 12021.89 |
| 1941-1945 MB and Ford GPW, Radiator Air Deflector Welting | 12021.86 |

| O. Wheels & Accessories | Part# |
|--|----------|
| 1941-1945 MB and Ford GPW, Steel Wheel, One Piece (Civilian Style) 16"x5.75" | 16725.01 |
| 1941-1945 MB and Ford GPW, Steel Wheel, Split (Military Style) 16"x5.75" | 16725.02 |
| 1941-1943 MB and Ford GPW, Tire Carrier, 2 Bolt Style | 12021.12 |
| 1941-1943 MB and Ford GPW, Tire Carrier Support Bracket | 12021.13 |
| 1941-1943 MB and Ford GPW, Tire Carrier Retainer Plate | 12021.14 |
| 1944-1945 MB and Ford GPW, Tire Carrier, 3 Bolt Style | 12021.11 |

Body kits, body tubs and body parts are sold "As Is". See Limited Warranty Information inside back cover. Drilling, cutting and other modifications may be required for proper installation. Claims for freight damage must be placed with freight carriers.

All images are subject to be representative. More detailed information is available online.



[A] 12001.07

[H] 12005.03

[F] 12004.05

[I] 12008.03

[H] DMC-663188

[G] 12009.05

[F] 12004.06

[D] DMC-681798

[E] DMC-670969

[B] 12002.06



AUTHENTIC RESTORATION PRODUCT

MOPAR, JEEP, DODGE, HEMI, PLYMOUTH, RAM, and CHRYSLER vehicles, images and logos are trademarks of Chrysler Group LLC used under license to Omix-Ada®. © Chrysler Group LLC 2011

Look for the star to check out all the Mopar Licensed Products



[C] 12201.01

| A. Steel Body Kits | Part# |
|--|---------------|
| 1945-1949 CJ2A, Body With Fenders, Hood, Windshield & Tailgate | 12001.07 |
| 1945-1949 CJ2A, Willys Stamped, Body With Fenders, Hood W/ Willys Script, Windshield & Tailgate W/ Willys Script | DMC-673859-2A |
| 1948-1953 CJ3A, Body With Fenders, Hood, Windshield & Tailgate | 12001.08 |
| 1948-1953 CJ3A, Willys Stamped, Body With Fenders, Hood W/ Willys Script, Windshield & Tailgate W/ Willys Script | DMC-673859-3A |
| 1953-1964 CJ3B, Body With Fenders, Hood, Windshield & Tailgate | 12001.09 |
| 1953-1967 CJ3B, Willys Stamped, Body With Fenders, Hood W/ Willys Script, Windshield & Tailgate W/ Willys Script | DMC-693197 |

| B. Steel Body Tubs | Part# |
|--------------------------|----------|
| 1945-1949 CJ2A, Body Tub | 12002.06 |
| 1948-1953 CJ3A, Body Tub | 12002.07 |
| 1953-1967 CJ3B, Body Tub | 12002.08 |

| C. Body Mounting Hardware | Part# |
|--|----------|
| 1945-1949 CJ2A, 1948-1953 CJ3A, 1953-1967 CJ3B, Body Mounting Kit, To Mount Body To Frame, Includes Washers, Rubber Spacers, and Bolts | 12201.01 |

| D. Grilles | Part# |
|---|------------|
| 1945-1946 CJ2A, Grille | DMC-663536 |
| 1947-1949 CJ2A, Grille | DMC-668124 |
| 1948-1953 CJ3A, Grille | DMC-673149 |
| 1959-1967 CJ3B, Grille With Willys Script | DMC-681798 |

| E. Hood & Components | Part# |
|---|------------|
| 1945-1949 CJ2A, 1948-1953 CJ3A, Hood With Willys Script | DMC-670969 |
| 1945-1949 CJ2A, 1948-1953 CJ3A, Hood | 12003.01 |
| 1953-1967 CJ3B Hood | 12003.03 |
| 1953-1967 CJ3B, Hood With Willys Script | DMC-681334 |
| 1945-1949 CJ2A, 1948-1953 CJ3A, 1953-1967 CJ3B, Hood Hinge [1 Required] | 12021.01 |

| F. Fenders & Components | Part# |
|--|----------|
| 1945-1949 CJ2A, Fender, Left | 12004.05 |
| 1945-1949 CJ2A, Fender, Right | 12004.06 |
| 1948-1953 CJ3A, 1953-1967 CJ3B, Fender Left | 12004.03 |
| 1948-1953 CJ3A, 1953-1967 CJ3B, Fender Right | 12004.04 |



| G. Body Panels | Part# |
|--|----------|
| 1945-1949 CJ2A, 1948-1953 CJ3A, Side (Quarter) Panel, Left | 12009.05 |
| 1945-1949 CJ2A, 1948-1953 CJ3A, Side (Quarter) Panel, Right | 12009.06 |
| 1945-1949 CJ2A, 1948-1953 CJ3A, Cowl Panel Top | 12025.11 |
| 1945-1949 CJ2A, 1948-1953 CJ3A, Cowl Side Panel, With Step, Left | 12010.05 |
| 1945-1949 CJ2A, 1948-1953 CJ3A, Cowl Side Panel, With Step, Right | 12010.06 |
| 1945-1949 CJ2A, 1948-1953 CJ3A, Cowl Side Step, Left | 12021.15 |
| 1945-1949 CJ2A, 1948-1953 CJ3A, Cowl Side Step, Right | 12021.16 |
| 1945-1949 CJ2A, 1948-1953 CJ3A, Firewall Panel | 12025.16 |
| 1945-1949 CJ2A, Wheel Well, Lower Rear, Left | 12025.43 |
| 1945-1949 CJ2A, Wheel Well, Lower Rear, Right | 12025.44 |
| 1945-1949 CJ2A, Wheel Well, Upper Rear, Left | 12025.41 |
| 1945-1949 CJ2A, Wheel Well, Upper Rear, Right | 12025.42 |
| 1948-1953 CJ3A, Wheel Well, Upper Rear, Left | 12025.19 |
| 1948-1953 CJ3A, Wheel Well, Upper Rear, Right | 12025.20 |
| 1948-1953 CJ3A, Wheel Well, Lower Rear, Left | 12025.21 |
| 1948-1953 CJ3A, Wheel Well, Lower Rear, Right | 12025.22 |
| 1945-1949 CJ2A, 1948-1953 CJ3A, 1953-1967 CJ3B, Fuel Filler Neck Housing | 12025.25 |
| 1945-1949 CJ2A, 1948-1953 CJ3A, Tail Light Panel, Left | 12025.17 |
| 1945-1949 CJ2A, 1948-1953 CJ3A, Tail Light Panel, Right | 12025.18 |

| H. Tailgates | Part# |
|---|------------|
| 1945-1949 CJ2A, 1948-1953 CJ3A, 1953-1967 CJ3B, Tailgate | 12005.03 |
| 1945-1949 CJ2A, 1948-1953 CJ3A, 1953-1967 CJ3B, Tailgate With Willys Script | DMC-663188 |
| 1945-1949 CJ2A, 1948-1953 CJ3A, 1953-1967 CJ3B, Tailgate Hinge [2 Required] | 12025.01 |

| I. Floor Pans & Frame Rails | Part# |
|--|----------|
| 1945-1949 CJ2A, 1948-1953 CJ3A, Floor Pan, Front, One Piece | 12007.03 |
| 1945-1949 CJ2A, 1948-1953 CJ3A, Floor Pan, Rear, One Piece | 12008.03 |
| 1945-1949 CJ2A, 1948-1953 CJ3A, 1953-1967 CJ3B, Rear Floor Bracket, Inner | 12021.55 |
| 1945-1949 CJ2A, 1948-1953 CJ3A, 1953-1967 CJ3B, Frame to Crossmember V Bracket | 12021.64 |
| 1945-1949 CJ2A, 1948-1953 CJ3A, 1953-1967 CJ3B, Body Outrigger [Frame] Mounts [6 Required] | 12025.31 |

Body kits, body tubs and body parts are sold "As Is". See Limited Warranty Information inside back cover. Drilling, cutting and other modifications may be required for proper installation. Claims for freight damage must be placed with freight carriers.



[J] 12006.04



[O] 16725.01



[N] 12301.02



OMIX-ADA®



[M] 12011.10



[K] 12025.35



[M] DMC-3227K



[L] 12025.34



[M] 12011.08

| J. Windshield Frame & Components | Part# |
|--|----------|
| 1945-1949 CJ2A, Windshield Frame Assembly, Includes Inner and Outer Frame | 12006.03 |
| 1948-1953 CJ3A, Windshield Frame | 12006.04 |
| 1945-1949 CJ2A, Inner Windshield Frame | 12025.03 |
| 1953-1967 CJ3B, Windshield Frame | 12006.05 |
| 1945-1949 CJ2A, Windshield Interior Latch, Center Mount | 12025.04 |
| 1945-1949 CJ2A, Windshield Adjusting Arm Assembly, Left | 12025.05 |
| 1945-1949 CJ2A, Windshield Adjusting Arm Assembly, Right | 12025.06 |
| 1945-1949 CJ2A, Windshield Adjusting Arm Thumb Bolt (Winged) [2 Required] | 12025.07 |
| 1945-1949 CJ2A, Windshield Ventilation Cover Kit, With Handle and Spring | 12025.08 |
| 1945-1949 CJ2A, Windshield Ventilation Handle & Spring Kit | 12025.09 |
| 1945-1949 CJ2A, 1948-1953 CJ3A, 1953-1967 CJ3B, Windshield Interior Latch, LH or RH [2 Required] | 12021.04 |
| 1945-1949 CJ2A, 1948-1953 CJ3A, 1953-1967 CJ3B, Windshield Pivot Bracket, Left | 12023.01 |
| 1945-1949 CJ2A, 1948-1953 CJ3A, 1953-1967 CJ3B, Windshield Pivot Bracket, Right | 12023.02 |
| 1945-1949 CJ2A, 1948-1953 CJ3A, 1953-1967 CJ3B, Windshield Tie Down Strap | 11825.20 |

| K. Top Frame | Part# |
|--|----------|
| 1945-1949 CJ2A, 1948-1953 CJ3A, Top Bow Bracket, Front, Center | 12025.37 |
| 1945-1949 CJ2A, 1948-1953 CJ3A, Top Bow Bracket, Front, Left | 12025.35 |
| 1945-1949 CJ2A, 1948-1953 CJ3A, Top Bow Bracket, Front, Right | 12025.36 |
| 1945-1949 CJ2A, 1948-1953 CJ3A, Top Bow Bracket, Rear, Left | 12025.39 |
| 1945-1949 CJ2A, 1948-1953 CJ3A, Top Bow Bracket, Rear, Right | 12025.38 |
| 1945-1949 CJ2A, 1948-1953 CJ3A, Top Bow Bracket, Rear | 12025.40 |

| L. Body Accessories | Part# |
|---|----------|
| 1945-1949 CJ2A, 1948-1953 CJ3A, 1953-1967 CJ3B, Round Mirrors, Black, Pair | 11001.01 |
| 1945-1949 CJ2A, 1948-1953 CJ3A, 1953-1967 CJ3B, Footman Loop, Chrome | 12023.28 |
| 1945-1949 CJ2A, 1948-1953 CJ3A, Battery Tray NEW | 12021.90 |
| 1945-1949 CJ2A, 1948-1953 CJ3A, Battery Tray Hold Down J-Bolt | 12021.82 |
| 1945-1949 CJ2A, 1948-1953 CJ3A, 1953-1967 CJ3B, Side Step (Pair), Later CJ5 Style | 12025.34 |
| 1945-1949 CJ2A, 1948-1953 CJ3A, 1953-1967 CJ3B, Jerry Can Carrier | 12021.62 |
| 1945-1949 CJ2A, 1948-1953 CJ3A, 1953-1967 CJ3B, Pintle Hook | 11550.01 |

| M. Interior | Part# |
|---|-----------|
| 1945-1949 CJ2A, 1948-1953 CJ3A, 1953-1967 CJ3B, Rear View Mirror | 11020.01 |
| 1945-1949 CJ2A, 1948-1953 CJ3A, Dash Panel, With Cutouts | 12025.15 |
| 1945-1949 CJ2A, 1948-1953 CJ3A, 1953-1967 CJ3B, Tool Box Lid | 12023.42 |
| 1945-1949 CJ2A, 1948-1953 CJ3A, 1953-1967 CJ3B, Tool Box Assembly With Lid | 12025.10 |
| 1945-1949 CJ2A, 1948-1953 CJ3A, 1953-1967 CJ3B, Toolbox With Jeep Script | DMC-3227K |
| 1945-1949 CJ2A, Seat Frame, Front, Left | 12011.09 |
| 1945-1949 CJ2A, Seat Frame, Front, Right | 12011.10 |
| 1945-1949 CJ2A, Seat Frame, Rear | 12011.08 |
| 1948-1953 CJ3A, 1953-1967 CJ3B, Seat Frame, Front, Left | 12011.13 |
| 1948-1953 CJ3A, 1953-1967 CJ3B, Seat Frame, Front, Right | 12011.14 |
| 1948-1953 CJ3A, 1953-1967 CJ3B, Seat Frame, Rear | 12011.12 |
| 1945-1949 CJ2A, 1948-1953 CJ3A, 1953-1967 CJ3B, 60" Seat Belt (Lap Belt), Black | 13202.04 |
| 1945-1949 CJ2A, 1948-1953 CJ3A, 1953-1967 CJ3B, 60" Seat Belt (Lap Belt), Tan NEW | 13202.20 |
| 1945-1949 CJ2A, 1948-1953 CJ3A, 1953-1967 CJ3B, 60" Seat Belt (Lap Belt), Gray NEW | 13202.30 |
| 1945-1949 CJ2A, 1948-1953 CJ3A, 1953-1967 CJ3B, 60" Seat Belt (Lap Belt), Olive Drab NEW | 13202.40 |
| 1945-1949 CJ2A, 1948-1953 CJ3A, 1953-1967 CJ3B, 60" Seat Belt Retractable (Lap Belt), Black | 13202.02 |
| 1945-1949 CJ2A, 1948-1953 CJ3A, 1953-1967 CJ3B, 60" Seat Belt Retractable (Lap Belt), Tan NEW | 13202.21 |
| 1945-1949 CJ2A, 1948-1953 CJ3A, 1953-1967 CJ3B, 60" Seat Belt Retractable (Lap Belt), Gray NEW | 13202.31 |
| 1945-1949 CJ2A, 1948-1953 CJ3A, 1953-1967 CJ3B, 60" Seat Belt Retractable (Lap Belt), Olive Drab NEW | 13202.41 |

| N. Weatherstrip | Part# |
|---|----------|
| 1945-1949 CJ2A, Windshield Weatherstrip, Inner to Outer Frame [1 Required] | 12301.01 |
| 1945-1949 CJ2A, Windshield Glass Seal, Seals Glass to Inner Frame [2 Required] | 12301.02 |
| 1945-1949 CJ2A, 1948-1953 CJ3A, 1953-1967 CJ3B, Windshield to Cowl Weatherstrip | 12302.01 |
| 1948-1953 CJ3A, 1953-1967 CJ3B, Windshield Weatherstrip | 12301.03 |
| 1945-1949 CJ2A, 1948-1953 CJ3A, 1953-1967 CJ3B, Fuel Filler Neck Grommet | 12025.23 |
| 1945-1949 CJ2A, 1948-1953 CJ3A, 1953-1967 CJ3B, Gas Tank Felt Kit (8 Piece Kit) | 12021.87 |
| 1945-1949 CJ2A, 1948-1953 CJ3A, 1953-1967 CJ3B, Radiator Air Deflector Welting | 12021.86 |

| O. Wheels & Accessories | Part# |
|---|----------|
| 1945-1949 CJ2A, 1948-1953 CJ3A, 1953-1967 CJ3B, Steel Wheel, One Piece (Civilian Style) 16"x5.75" | 16725.01 |
| 1945-1949 CJ2A, 1948-1953 CJ3A, 1953-1967 CJ3B, Spare Tire Carrier | 12025.27 |



AUTHENTIC RESTORATION PRODUCT

MOPAR, JEEP, DODGE, HEMI, PLYMOUTH, RAM, and CHRYSLER vehicles, images and logos are trademarks of Chrysler Group LLC used under license to Omix-Ada®, © Chrysler Group LLC 2011

Look for the star to check out all the Mopar Licensed Products

All images are subject to be representative. More detailed information is available online.



| A. Steel Body Kits | Part# |
|--|----------|
| 1955-1968 CJ5, Body With Fenders, Hood, Windshield & Tailgate | 12001.10 |
| 1969 CJ5, Body With Fenders, Hood, Windshield & Tailgate | 12001.11 |
| 1970-1971 CJ5, Body With Fenders, Hood, Windshield & Tailgate | 12001.12 |
| 1972-1975 CJ5, Body With Fenders, Hood, Windshield & Tailgate | 12001.13 |
| 1955-1968 CJ6, Body With Fenders, Hood, Windshield & Tailgate | 12001.14 |
| 1969-1971 CJ6, Body With Fenders, Hood, Windshield & Tailgate NEW | 12001.19 |
| 1952-1971 M38A1, Body With Fenders, Hood, Windshield & Tailgate | 12001.15 |

| B. Steel Body Tubs | Part# |
|---|---------------|
| 1955-1969 CJ5, Body Tub | 12002.09 |
| 1955-1969 CJ5, Body Tub, With Jeep Script Stamped In Cowl Sides | DMC-680637 |
| 1970-1971 CJ5, Body Tub | 12002.10 |
| 1970-1971 CJ5, Body Tub, With Jeep Script Stamped In Cowl Sides | DMC-680637-VC |
| 1972-1975 CJ5, Body Tub | 12002.11 |
| 1972-1975 CJ5, Body Tub, With Jeep Script Stamped In Cowl Sides | DMC-680637-VD |
| 1955-1971 CJ6, Body Tub | 12002.12 |

| C. Body Mounting Hardware | Part# |
|---|----------|
| 1955-1975 CJ5 & CJ6, 1952-1971 M38A1, To Mount Body To Frame, Includes Washers, Rubber Spacers, and Bolts | 12201.01 |
| 1972-1975 CJ5 & CJ6, Body Mounting Washer Kit [8 Pieces] | 12217.01 |
| 1955-1971, CJ5 & CJ6, Body Fastner Kit [405 Pieces] | 12215.01 |
| 1972-1975, CJ5 & CJ6, Body Fastner Kit, Without Tailgate [456 Pieces] | 12215.03 |
| 1955-1975, CJ5 & CJ6, Body Fastner Kit, With Tailgate [539 Pieces] | 12215.02 |

| D. Grilles | Part# |
|-----------------------------|-------------|
| 1955-1971 CJ5 & CJ6, Grille | DMC-815385 |
| 1972-1975 CJ5 & CJ6, Grille | DMC-5752656 |

| E. Hood & Components | Part# |
|--|----------|
| 1955-1975 CJ5 & CJ6, 1952-1971 M38A1, Hood | 12003.04 |
| 1972-1975 CJ5 & CJ6, Hood | 12003.05 |

| F. Fenders & Components | Part# |
|---|----------|
| 1955-1975 CJ5 & CJ6, 1952-1971 M38A1, Fender Left | 12004.07 |
| 1955-1975 CJ5 & CJ6, 1952-1971 M38A1, Fender Right | 12004.08 |
| 1969-1971 CJ5 & CJ6, Fender, With Side Marker Indent, Left | 12004.09 |
| 1969-1971 CJ5 & CJ6, Fender, With Side Marker Indent, Right | 12004.10 |
| 1972-1975 CJ5 & CJ6, Fender, With Side Marker Indent, Left | 12004.11 |
| 1972-1975 CJ5 & CJ6, Fender, With Side Marker Indent, Right | 12004.12 |

| G. Floor Pans & Frame Rails | Part# |
|---|----------|
| 1955-1969 CJ5 & CJ6, 1952-1971 M38A1, Floor Pan, Front [One Piece] | 12007.04 |
| 1970-1975 CJ5 & CJ6, Floor Pan, Front [One Piece] NEW | 12007.07 |
| 1955-1975 CJ5 & CJ6, 1952-1971 M38A1, Floor Pan, Rear [One Piece] | 12008.04 |
| 1955-1971 CJ5 & CJ6, 1952-1971 M38A1, Transmission Floor Access Cover, Center | 12027.02 |

| I. Windshield Frame & Components | Part# |
|--|----------|
| 1955-1968 CJ5 & CJ6, Windshield Frame, With Top Mounted Wipers | 12006.06 |
| 1967-1975 CJ5 & CJ6, Windshield Frame, With Bottom Mounted Wipers | 12006.07 |
| 1955-1975 CJ5 & CJ6, 1952-1971 M38A1, Windshield Hinge Set | 12027.07 |
| 1955-1975 CJ5 & CJ6, 1952-1971 M38A1, Windshield Hinge, Upper, Left | 12027.03 |
| 1955-1975 CJ5 & CJ6, 1952-1971 M38A1, Windshield Hinge, Upper, Right | 12027.04 |
| 1955-1975 CJ5 & CJ6, 1952-1971 M38A1, Windshield Hinge, Lower, Left | 12027.05 |
| 1955-1975 CJ5 & CJ6, 1952-1971 M38A1, Windshield Hinge, Lower, Right | 12027.06 |
| 1955-1975 CJ5 & CJ6, 1952-1971 M38A1, Windshield Tie Down Strap | 11825.20 |

| J. Tailgates | Part# |
|---|------------|
| 1955-1975 CJ5 & CJ6, Tailgate | 12005.03 |
| 1955-1968 CJ5 & CJ6, Tailgate, With Willys Script | DMC-663188 |
| 1969-1975 CJ5 & CJ6, Tailgate, With Jeep Script | DMC-685459 |
| 1952-1971 M38A1 Rear Tailgate Panel | 12005.04 |
| 1955-1975 CJ5 & CJ6, Tailgate Hinge [2 Required] | 12025.01 |

| K. Bumpers & Components | Part# |
|---|----------|
| 1955-1975 CJ5 & CJ6, 1952-1971 M38A1, Front Bumper | 12029.03 |
| 1955-1975 CJ5 & CJ6, 1952-1971 M38A1, Rear Bumper [Crossmember] | 12027.01 |

Body kits, body tubs and body parts are sold "As Is". See Limited Warranty Information inside back cover. Drilling, cutting and other modifications may be required for proper installation. Claims for freight damage must be placed with freight carriers.

1955-1975 CJ5, 1955-1975 CJ6, 1952-1971 M38A1



| L. Fender Flares | Part# |
|---|----------|
| 1955-1975 CJ5, Fender Flare Kit (Includes hardware) | 11601.01 |
| 1955-1975 CJ5 & CJ6, Fender Flare, Front, Left | 11601.03 |
| 1955-1975 CJ5 & CJ6, Fender Flare, Front, Right | 11601.02 |
| 1955-1975 CJ5, Fender Flare, Rear, Left | 11601.05 |
| 1955-1975 CJ5, Fender Flare, Rear, Right | 11601.04 |
| 1955-1975 CJ5 & CJ6, Fender Flare Hardware Kit | 11601.06 |

| M. Body Accessories | Part# |
|---|-------------|
| 1955-1964 CJ5 & CJ6, 1952-1964 M38A1, Round Mirrors, Black, Pair | 11001.01 |
| 1965-1975 CJ5 & CJ6, 1955-1971 M38A1, Square Mirrors, Black, Pair | 11001.02 |
| 1965-1975 CJ5 & CJ6, 1955-1971 M38A1, Square Mirrors, Convex, Black, Pair | 11001.03 |
| 1965-1975 CJ5 & CJ6, 1955-1971 M38A1, Square Mirrors, Stainless Steel, Pair | 11005.01 |
| 1965-1975 CJ5 & CJ6, 1955-1971 M38A1, Square Mirrors, Convex, Stainless Steel, Pair | 11005.02 |
| 1965-1975 CJ5 & CJ6, 1955-1971 M38A1, Square Mirrors, Chrome, Pair | 11010.01 |
| 1955-1971 CJ5 & CJ6, 1952-1971 M38A1, Side Steps (Pair) | 12025.34 |
| 1955-1971 CJ5 & CJ6, 1952-1971 M38A1, Jerry Can Carrier | 12021.62 |
| 1955-1971 CJ5 & CJ6, 1952-1971 M38A1, Pintle Hook | 11550.01 |
| 1955-1975 CJ5, CJ5 Emblem (Self Adhesive) [OE for 1972 & up] NEW | DMC-5455179 |
| 1955-1975 CJ5 & CJ6, Jeep Emblem (Self Adhesive) [OE for 1972 & up] NEW | DMC-5451627 |

| N. Interior | Part# |
|---|-----------|
| 1972-1975 CJ5 & CJ6, Torx Head Dash Bolt | 17258.01 |
| 1955-1975 CJ5 & CJ6, 1952-1971 M38A1, Grab Bar Handle, Stainless Steel | 11123.01 |
| 1955-1975 CJ5 & CJ6, 1952-1971 M38A1, Grab Bar Handle, Black | 11203.01 |
| 1955-1975 CJ5 & CJ6, Glove Box Door, Black | 11228.01 |
| 1955-1975 CJ5 & CJ6, Glove Box Door, Stainless Steel | 11125.01 |
| 1955-1971 CJ5 & CJ6, Glove Box Insert, Extra Large Capacity (Plastic) | 13316.03 |
| 1955-1971 CJ5 & CJ6, Glove Box Insert (Plastic) NEW | 13316.02 |
| 1972-1975 CJ5 & CJ6, Glove Box Insert (Plastic) NEW | 13316.01 |
| 1968-1975 CJ5 & CJ6, Heater & Wiper Switch Knob, Black | 13318.05 |
| 1973-1975 CJ5 & CJ6, Heater & Wiper Switch Knob, Black | 13318.06 |
| 1955-1971 CJ5 & CJ6, 1952-1971 M38A1, Rear View Mirror | 11020.01 |
| 1955-1971 CJ5 & CJ6, 1952-1971 M38A1, Tool Box Compartment, With Lid | 12025.10 |
| 1955-1975 CJ5 & CJ6, 1952-1971 M38A1, Toolbox With Jeep Script | DMC-3227K |
| 1955-1971 CJ5 & CJ6, 1952-1971 M38A1, Tool Box Compartment Lid | 12023.42 |
| 1972-1975 CJ5 & CJ6, Sun Visor, Black, LH or RH | 13301.01 |
| 1972-1975 CJ5 & CJ6, Sun Visor, Gray, LH or RH | 13301.09 |
| 1972-1975 CJ5 & CJ6, Sun Visor, Charcoal, LH or RH | 13301.15 |
| 1972-1975 CJ5 & CJ6, Sun Visor, Spice, LH or RH | 13301.37 |
| 1955-1971 CJ5 & CJ6, 1952-1971 M38A1, 60" Seat Belt (Lap Belt), Black | 13202.04 |
| 1955-1971 CJ5 & CJ6, 1952-1971 M38A1, 60" Seat Belt (Lap Belt), Tan NEW | 13202.20 |
| 1955-1971 CJ5 & CJ6, 1952-1971 M38A1, 60" Seat Belt (Lap Belt), Gray NEW | 13202.30 |
| 1955-1971 CJ5 & CJ6, 1952-1971 M38A1, 60" Seat Belt (Lap Belt), Olive Drab NEW | 13202.40 |
| 1955-1971 CJ5 & CJ6, 1952-1971 M38A1, 60" Seat Belt Retractable (Lap Belt), Black | 13202.02 |
| 1955-1971 CJ5 & CJ6, 1952-1971 M38A1, 60" Seat Belt Retractable (Lap Belt), Tan NEW | 13202.21 |
| 1955-1971 CJ5 & CJ6, 1952-1971 M38A1, 60" Seat Belt Retractable (Lap Belt), Gray NEW | 13202.31 |
| 1955-1971 CJ5 & CJ6, 1952-1971 M38A1, 60" Seat Belt Retractable (Lap Belt), Olive Drab NEW | 13202.41 |

| O. Weatherstrip & Felt | Part# |
|---|----------|
| 1955-1975 CJ5 & CJ6, 1952-1971 M38A1, Windshield Weatherstrip | 12301.03 |
| 1955-1975 CJ5 & CJ6, 1952-1971 M38A1, Windshield to Cowl Weatherstrip | 12302.02 |
| 1972-1975 CJ5 & CJ6, Grille to Hood Grommet (Bumper) [4 Required] | 12029.01 |
| 1955-1971 CJ5 & CJ6, 1952-1971 M38A1, Fuel Filler Neck Housing | 12025.25 |
| 1955-1969 CJ5 & CJ6, 1952-1971 M38A1, Gas Tank Felt Kit [8 Piece Kit] | 12021.87 |

| P. Wheels & Accessories | Part# |
|--|----------|
| 1955-1971 CJ5 & CJ6, 1952-1971 M38A1, One Piece Wheel [Civilian Style] 16"x5.75" | 16725.01 |
| 1955-1971 CJ5 & CJ6, 1952-1971 M38A1, Tire Carrier | 12025.27 |



All images are subject to be representative. More detailed information is available online.



Look for the star to check out all the Mopar Licensed Products



Body Parts

1950-1952 M38 Body Parts



| A. Steel Body Kits | Part# |
|---|----------|
| 1950-1952 M38, Body With Fenders, Hood, Windshield & Tailgate | 12001.05 |
| B. Steel Body Tubs | Part# |
| 1950-1952 M38, Body Tub | 12002.04 |
| C. Body Mounting Hardware | Part# |
| 1950-1952 M38, Body Mounting Kit, To Mount Body To Frame, Includes Washers, Rubber Spacers, and Bolts | 12201.01 |
| D. Hood & Components | Part# |
| 1950-1952 M38, Hood | 12003.02 |
| 1950-1952 M38, Hood Hinge, [1 Required] | 12021.01 |
| E. Fenders & Components | Part# |
| 1950-1952 M38, Fender, Left | 12004.03 |
| 1950-1952 M38, Fender, Right | 12004.04 |
| F. Body Panels | Part# |
| 1950-1952 M38, Side [Quarter] Panel, Left | 12009.03 |
| 1950-1952 M38, Side [Quarter] Panel, Right | 12009.04 |
| 1950-1952 M38, Cowl Side Panel, With Step, Left | 12010.03 |
| 1950-1952 M38, Cowl Side Panel, With Step, Right | 12010.04 |
| 1950-1952 M38, Cowl Side Panel Step, Left | 12021.15 |
| 1950-1952 M38, Cowl Side Panel Step, Right | 12021.16 |
| 1950-1952 M38, Cowl Panel Top | 12023.47 |
| 1950-1952 M38, Door Channel, Left | 12023.33 |
| 1950-1952 M38, Door Channel, Right | 12023.32 |
| 1950-1952 M38, Door Hinge Bracket, Left | 12023.35 |
| 1950-1952 M38, Door Hinge Bracket, Right | 12023.34 |
| G. Tailgates | Part# |
| 1950-1952 M38, Tailgate | 12005.02 |
| 1950-1952 M38, Tailgate Hine, LH or RH | 12023.22 |
| H. Floor Panel | Part# |
| 1950-1952 M38, Floor Pan, Front, One Piece | 12007.02 |
| 1950-1952 M38, Floor Pan, Rear, One Piece | 12008.02 |
| 1950-1952 M38, Floor Drain Hole Cover [2 Required] | 12023.38 |
| 1950-1952 M38, Floor Access Cover for Brake Master Cylinder | 12023.37 |
| 1950-1952 M38, Transmission Floor Access Cover, Center | 12023.39 |
| 1950-1952 M38, Transmission & Transfer Case Crossmember | 12023.18 |
| 1950-1952 M38, Intermediate Frame Crossmember | 12023.48 |
| I. Windshield Frame & Components | Part# |
| 1950-1952 M38, Windshield Frame | 12006.02 |
| 1950-1952 M38, Windshield Pivot Bracket, Right | 12023.02 |
| 1950-1952 M38, Windshield Pivot Bracket, Left | 12023.01 |
| 1950-1952 M38, Windshield Pivot Bolt [2 Required] | 12023.03 |
| 1950-1952 M38, Windshield Hood Rest [Wooden] | 12023.05 |
| 1950-1952 M38, Ventilator Cover [Windshield Mounted] | 12023.06 |
| 1950-1952 M38, Windshield Top Retainer Channel | 12023.46 |
| 1950-1952 M38, Windshield Interior Latch, LH or RH [2 Required] | 12023.04 |

| J. Bumpers & Components | Part# |
|--|----------|
| 1950-1952 M38, Front Bumper | 12023.19 |
| 1950-1952 M38, Rear Bumper [Crossmember] | 12023.20 |
| K. Body Accessories | Part# |
| 1950-1952 M38, Round Mirrors, Black, Pair | 11001.01 |
| 1950-1952 M38, Footman Loop, Olive Drab | 12023.27 |
| 1950-1952 M38, Footman Loop, Chrome | 12023.28 |
| 1950-1952 M38, Axe Sheath | 12023.25 |
| 1950-1952 M38, Axe Clamp, Front | 12023.24 |
| 1950-1952 M38, Shovel Bracket | 12023.26 |
| 1950-1952 M38, Radio Bracket | 12023.29 |
| 1950-1952 M38, First Aid Kit Mounting Bracket | 12023.40 |
| 1950-1952 M38, Machine Gun Mounting Bracket | 12023.31 |
| 1950-1952 M38, Fuel Filler Brush Guard | 12023.30 |
| 1950-1952, Jerry Can Carrier | 12021.62 |
| L. Top Frame | Part# |
| 1950-1952 M38, Convertible Top Frame [Bow] Assembly | 12023.12 |
| 1950-1952 M38, Top Bow Storage Bracket, Rear | 12023.14 |
| 1950-1952 M38, Top Bow Socket [2 Required] | 12023.13 |
| 1950-1952 M38, Top Bow Storage Bracket, Front | 12023.15 |
| M. Interior | Part# |
| 1950-1952 M38, Rear View Mirror | 11020.01 |
| 1950-1952 M38, Instrument Cluster | 12023.36 |
| 1950-1952 M38, Glove Box Door | 12023.41 |
| 1950-1952 M38, Tool Box Lid | 12023.42 |
| 1950-1952 M38, Seat Frame, Front, Left | 12011.05 |
| 1950-1952 M38, Seat Frame, Front, Right | 12011.06 |
| 1950-1952 M38, Seat Frame, Rear | 12011.07 |
| 1950-1952 M38, Rear Seat to Wheelhouse Support | 12023.07 |
| 1950-1952 M38, Rear Seat Pivot Bracket | 12023.08 |
| 1950-1952 M38, Rear Seat Pivot Retainer | 12023.09 |
| 1950-1952 M38, Rear Seat Frame Spring Retainer [2 Required] | 12023.10 |
| 1950-1952 M38, 60" Seat Belt [Lap Belt], Black | 13202.04 |
| 1950-1952 M38, 60" Seat Belt [Lap Belt], Tan NEW | 13202.20 |
| 1950-1952 M38, 60" Seat Belt [Lap Belt], Gray NEW | 13202.30 |
| 1950-1952 M38, 60" Seat Belt [Lap Belt], Olive Drab NEW | 13202.40 |
| 1950-1952 M38, 60" Seat Belt Retractable [Lap Belt], Black | 13202.02 |
| 1950-1952 M38, 60" Seat Belt Retractable [Lap Belt], Tan NEW | 13202.21 |
| 1950-1952 M38, 60" Seat Belt Retractable [Lap Belt], Gray NEW | 13202.31 |
| 1950-1952 M38, 60" Seat Belt Retractable [Lap Belt], Olive Drab NEW | 13202.41 |
| N. Weatherstrip & Felt | Part# |
| 1950-1952 M38, Windshield Weatherstrip | 12301.03 |
| 1950-1952 M38, Windshield to Cowl Weatherstrip | 12302.01 |
| 1950-1952 M38, Fuel Filler Neck Grommet | 12023.11 |
| 1950-1952 M38, Gas Tank Felt Kit | 12021.87 |
| 1950-1952 M38, Radiator Air Deflector Welting | 12021.86 |
| O. Wheels & Accessories | Part# |
| 1950-1952 M38, Steel Wheel, One Piece [Civilian Style] 16"x5.75" | 16725.01 |
| 1950-1952 M38, Spare Tire Carrier | 12023.16 |
| 1950-1952 M38, Tire Carrier Mounting Bracket Retainer | 12023.17 |

Body kits, body tubs and body parts are sold "As Is". See Limited Warranty Information inside back cover. Drilling, cutting and other modifications may be required for proper installation. Claims for freight damage must be placed with freight carriers.

1976-1983 CJ5, 1976-1986 CJ7, 1981-1986 CJ8 Body Parts



[E] 12003.05



[I] 12029.27



[I] 12005.03



[G] 12007.05



[H] 12006.08



[A] 12001.17



[H] 19135.01



[B] 12002.13



[C] 12201.02



[D] DMC-5752656



MOPAR, JEEP, DODGE, HEMI, PLYMOUTH, RAM, and CHRYSLER vehicles, images and logos are trademarks of Chrysler Group LLC used under license to Omix-Ada®, © Chrysler Group LLC 2011.

Look for the star to check out all the Mopar Licensed Products



[F] 12004.11



[F] 12004.12

A. Steel Body Kits

| | Part# |
|---|----------|
| 1976-1986 CJ7, Body With Fenders, Hood, Windshield & Tailgate | 12001.17 |
| 1981-1986 CJ8 Scrambler, Body With Fenders, Hood, Windshield & Tailgate | 12001.18 |

B. Steel Body Tubs

| | Part# |
|---|-------------|
| 1976-1983 CJ5, Body Tub | 12002.13 |
| 1976-1983 CJ5, Body Tub, With Jeep Script Stamped In Cowl Sides | DMC-5461335 |
| 1976-1986 CJ7, Body Tub | 12002.14 |
| 1976-1986 CJ7, Body Tub, With Jeep Script Stamped In Cowl Sides | DMC-5464362 |
| 1981-1986 CJ8 Scrambler, Body Tub | 12002.15 |

C. Body Mounting Hardware

| | Part# |
|--|----------|
| 1976-1983 CJ5, 1976-1986 CJ7, 1981-1986 CJ8, Body Mount Bushing Kit [Polyurethane] | 12201.02 |
| 1976-1986 CJ7, Body Mount Bushing Kit, For Fiberglass Bodies [Polyurethane] | 12201.03 |
| 1976-1983 CJ5, Body Fastener Kit, Without Tailgate [582 Pieces] | 12215.05 |
| 1976-1983 CJ5, Body Fastener Kit, With Tailgate [624 Pieces] | 12215.04 |
| 1976-1986 CJ7, Body Fastener Kit, With Soft Top [620 Pieces] | 12215.07 |
| 1976-1986 CJ7, Body Fastener Kit, With Hardtop [785 Pieces] | 12215.06 |
| 1981-1986 CJ8, Body Fastener Kit, With Soft Top [640 Pieces] | 12215.10 |
| 1981-1986 CJ8, Body Fastener Kit, With Hardtop [714 Pieces] | 12215.09 |

D. Grilles

| | Part# |
|---|-------------|
| 1976-1983 CJ5, 1976-1986 CJ7, 1981-1986 CJ8, Grille | DMC-5752656 |

E. Hood & Components

| | Part# |
|--|----------|
| 1976-1983 CJ5, 1976-1986 CJ7, 1981-1986 CJ8, Hood | 12003.05 |
| 1976-1983 CJ5, 1976-1986 CJ7, 1981-1986 CJ8, Hood Hinge Bolt | 12029.30 |

F. Fenders & Components

| | Part# |
|--|----------|
| 1976-1983 CJ5, 1976-1986 CJ7, 1981-1986 CJ8, Fender, Left | 12004.11 |
| 1976-1983 CJ5, 1976-1986 CJ7, 1981-1986 CJ8, Fender, Right | 12004.12 |

G. Floor Pans

| | Part# |
|--|----------|
| 1976-1983 CJ5, Floor Panel, One Piece, Front | 12007.05 |
| 1976-1986 CJ7, 1981-1986 CJ8, Floor Panel, One Piece, Front | 12007.06 |
| 1976-1983 CJ5, Floor Panel, One Piece, Rear | 12008.05 |
| 1976-1986 CJ7, Floor Panel, One Piece, Rear | 12008.06 |
| 1976-1983 CJ5, 1976-1986 CJ7, 1981-1986 CJ8, Floor Grommet [1" Diameter] | 12029.19 |

H. Windshield Frame & Components

| | Part# |
|---|----------|
| 1976-1983 CJ5, 1976-1986 CJ7, 1981-1986 CJ8, Windshield Frame | 12006.08 |
| 1976-1983 CJ5, 1976-1986 CJ7, 1981-1986 CJ8, Windshield Glass | 12029.10 |
| 1976-1983 CJ5, 1976-1986 CJ7, 1981-1986 CJ8, Windshield Hinge Set | 12029.07 |
| 1976-1983 CJ5, 1976-1986 CJ7, 1981-1986 CJ8, Windshield Hinge, Left | 12029.09 |
| 1976-1983 CJ5, 1976-1986 CJ7, 1981-1986 CJ8, Windshield Hinge, Right | 12029.08 |
| 1976-1983 CJ5, 1976-1986 CJ7, 1981-1986 CJ8, Windshield Hinge Screw [16 Required] | 12029.06 |
| 1976-1983 CJ5, 1976-1986 CJ7, 1981-1986 CJ8, Windshield Frame Wiper Access Hole Cover | 13318.02 |
| 1976-1983 CJ5, 1976-1986 CJ7, 1981-1986 CJ8, Windshield Frame Knob, Black | 13318.01 |
| 1976-1983 CJ5, 1976-1986 CJ7, 1981-1986 CJ8, Windshield Wiper Motor Cover | 19135.01 |
| 1976-1983 CJ5, 1976-1986 CJ7, 1981-1986 CJ8, Windshield Tie Down Strap | 11825.20 |

I. Tailgates

| | Part# |
|---|-------------|
| 1976-1983 CJ5, Tailgate | 12005.03 |
| 1976-1983 CJ5, Tailgate, With Jeep Script | DMC-685459 |
| 1976-1986 CJ7, 1981-1986 CJ8, Tailgate | 12005.05 |
| 1976-1986 CJ7, 1981-1986 CJ8, Tailgate, With Jeep Script | DMC-5454025 |
| 1976-1983 CJ5, Tailgate Hinge, LH or RH | 12023.22 |
| 1976-1986 CJ7, 1981-1986 CJ8, Tailgate Cable, [2 Required] | 12029.02 |
| 1976-1986 CJ7, 1981-1986 CJ8, Tailgate Latch Bracket Set [Bracket w/ Mounting Hardware] [Pair] | 12029.27 |
| 1976-1986 CJ7, 1981-1986 CJ8, Tailgate Latch Bracket Kit [Bracket w/ Mounting Hardware] [Does One Side] | 12029.26 |
| 1976-1986 CJ7, 1981-1986 CJ8, Tailgate Latch Bracket | 12029.25 |
| 1976-1986 CJ7, 1981-1986 CJ8, Tailgate Latch Bolt | 12029.28 |
| 1976-1986 CJ7, 1981-1986 CJ8, Tailgate Latch Wave Washer | 12029.29 |

Body kits, body tubs and body parts are sold "As Is". See Limited Warranty Information inside back cover. Drilling, cutting and other modifications may be required for proper installation. Claims for freight damage must be placed with freight carriers.

All images are subject to be representative. More detailed information is available online.



AUTHENTIC RESTORATION PRODUCT

MOPAR, JEEP, DODGE, HEMI, PLYMOUTH, RAM, and CHRYSLER vehicles, images and logos are trademarks of Chrysler Group LLC used under license to Omix-Ada®. © Chrysler Group LLC 2011

Look for the star to check out all the Mopar Licensed Products

[N] DMC-5457017

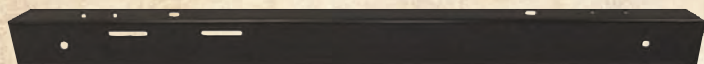
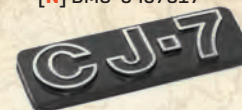

[K] 12029.03



[K] 12029.04



[K] 11215.01



[L] 11601.01



[J] 12029.13



[J] 12029.14



[J] 12009.09



[M] 11810.01



[M] 11901.04



[M] 11901.03

J. Body Panels

| Part# | Part# |
|--|-------------|
| 1976-1983 CJ5, Side [Quarter] Panel, Left | 12009.07 |
| 1976-1983 CJ5, Side [Quarter] Panel, Right | 12009.08 |
| 1976-1983 CJ5, Side Panel With Jeep Script, Left NEW | DMC-8133112 |
| 1976-1983 CJ5, Side Panel With Jeep Script, Right NEW | DMC-8133337 |
| 1976-1986 CJ7, Side [Quarter] Panel, Left | 12009.09 |
| 1976-1986 CJ7, Side [Quarter] Panel, Right | 12009.10 |
| 1976-1986 CJ7, Side Panel With Jeep Script, Left NEW | DMC-8133339 |
| 1976-1986 CJ7, Side Panel With Jeep Script, Right NEW | DMC-8133338 |
| 1976-1986 CJ7, Cowl Side, With Door Opening, Left | 12009.11 |
| 1976-1986 CJ7, Cowl Side, With Door Opening, Right | 12009.12 |
| 1981-1986 CJ8, Side [Quarter] Patch Panel, Left [Behind Door Opening] | 12009.13 |
| 1981-1986 CJ8, Side [Quarter] Patch Panel, Right [Behind Door Opening] | 12009.14 |
| 1976-1983 CJ5, 1976-1986 CJ7, 1981-1986 CJ8, Cowl Top Panel | 12029.17 |
| 1976-1983 CJ5, 1976-1986 CJ7, 1981-1986 CJ8, Firewall Panel | 12029.18 |
| 1976-1986 CJ7, Wheel Housing, Rear, Left | 12029.16 |
| 1976-1986 CJ7, Wheel Housing, Rear, Right | 12029.15 |
| 1981-1986 CJ8, Wheel Housing, Rear, Left | 12029.33 |
| 1981-1986 CJ8, Wheel Housing, Rear, Right | 12029.34 |
| 1981-1986 CJ8, Wheel Housing Inner Corner, Rear, Right | 12029.34 |
| 1981-1986 CJ8, Wheel Housing Inner Corner, Rear, Left | 12029.33 |
| 1976-1983 CJ5, Tail Light Panel, Left | 12029.11 |
| 1976-1983 CJ5, Tail Light Panel, Right | 12029.12 |
| 1976-1986 CJ7, Tail Light Panel, Left | 12029.13 |
| 1976-1986 CJ7, Tail Light Panel, Right | 12029.14 |

K. Bumpers & Components

| Part# | Part# |
|--|----------|
| 1976-1983 CJ5, 1976-1986 CJ7, 1981-1986 CJ8, Front Bumper | 12029.03 |
| 1976-1983 CJ5, 1976-1986 CJ7, 1981-1986 CJ8, Rear Bumper [Crossmember] | 12029.04 |
| 1976-1983 CJ5, 1976-1986 CJ7, 1981-1986 CJ8, Rear Bumperettes | 11215.01 |

L. Fender Flares

| Part# | Part# |
|---|----------|
| 1976-1983 CJ5, 1976-1986 CJ7 Fender Flare Kit [Includes hardware] | 11601.01 |
| 1976-1983 CJ5, 1976-1986 CJ7 Fender Flare, Front, Left | 11601.03 |
| 1976-1983 CJ5, 1976-1986 CJ7 Fender Flare, Front, Right | 11601.02 |
| 1976-1983 CJ5, 1976-1986 CJ7 Fender Flare, Rear, Left | 11601.05 |
| 1976-1983 CJ5, 1976-1986 CJ7 Fender Flare, Rear, Right | 11601.04 |
| 1976-1983 CJ5, 1976-1986 CJ7 Fender Flare Hardware Kit | 11601.06 |

M. Body Accessories

| Part# | Part# |
|---|----------|
| 1976-1980 CJ7, Door Handle With Key [For Full Steel Doors], Chrome, Pair [Keyed Alike] | 11812.02 |
| 1976-1980 CJ7, Door Handle With Key [For Full Steel Doors], LH or RH | 11812.01 |
| 1981-1986 CJ7, 1981-1986 CJ8, Door Paddle Handle [With Full Steel Doors], Black, Left | 11812.05 |
| 1981-1986 CJ7, 1981-1986 CJ8, Door Paddle Handle [With Full Steel Doors], Black, Right | 11812.06 |
| 1981-1986 CJ7, 1981-1986 CJ8, Door Paddle Handle [With Full Steel Doors], Chrome, Left | 11812.03 |
| 1981-1986 CJ7, 1981-1986 CJ8, Door Paddle Handle [With Full Steel Doors], Chrome, Right | 11812.04 |
| 1981-1986 CJ7, 1981-1986 CJ8, Door Latch Bracket [With Full Steel Doors], Black, Left | 11810.01 |
| 1981-1986 CJ7, 1981-1986 CJ8, Door Latch Bracket [With Full Steel Doors], Black, Right | 11810.02 |
| 1981-1986 CJ7, 1981-1986 CJ8, Door Latch Bracket Set [With Full Steel Doors], Stainless Steel, pair | 11810.05 |
| 1981-1986 CJ7, 1981-1986 CJ8, Door Latch Bracket [With Full Steel Doors], Stainless Steel, Left | 11810.03 |
| 1981-1986 CJ7, 1981-1986 CJ8, Door Latch Bracket [With Full Steel Doors], Stainless Steel, Right | 11810.04 |
| 1981-1986 CJ7, 1981-1986 CJ8, Door Latch Striker Plate [With Full Steel Doors], LH or RH | 11811.01 |
| 1981-1986 CJ7, 1981-1986 CJ8, Door Latch Striker Pin, LH or RH | 11811.02 |
| 1976-1986 CJ7, 1981-1986 CJ8, Hardtop Liftgate T-Handle | 11901.02 |
| 1976-1986 CJ7, 1981-1986 CJ8, Liftgate Latch [For Hardtop] [2 Required] | 11901.04 |
| 1976-1986 CJ7, 1981-1986 CJ8, Liftgate Cable Cam Assembly, With Cables [For Hardtop] | 11901.03 |
| 1976-1986 CJ7, 1981-1986 CJ8, Hardtop Liftgate Hinge, LH or RH | 11901.01 |
| 1976-1986 CJ7, 1981-1986 CJ8, Liftgate Latch [For Hardtop] [2 Required] NEW | 11813.01 |
| 1976-1986 CJ5, 1976-1986 CJ7, 1981-1986 CJ8 Footman Loop Kit, Stainless Steel | 11105.01 |
| 1965-1975 CJ5 & CJ6, 1955-1971 M38A1, Square Mirrors, Black, Pair | 11001.02 |
| 1965-1975 CJ5 & CJ6, 1955-1971 M38A1, Square Mirrors, Convex, Black, Pair | 11001.03 |
| 1965-1975 CJ5 & CJ6, 1955-1971 M38A1, Square Mirrors, Stainless Steel, Pair | 11005.01 |
| 1965-1975 CJ5 & CJ6, 1955-1971 M38A1, Square Mirrors, Convex, Stainless Steel, Pair | 11005.02 |
| 1965-1975 CJ5 & CJ6, 1955-1971 M38A1, Square Mirrors, Chrome, Pair | 11010.01 |

N. Exterior Emblems

| Part# | Part# |
|---|-------------|
| 1976-1983 CJ5, 1976-1986 CJ7, 1981-1986 CJ8, Jeep AMC Flag Emblem, Self Adhesive NEW | DMC-5451627 |
| 1976-1983 CJ5, "CJ5" Emblem, Self Adhesive NEW | DMC-5455179 |
| 1976-1986 CJ7, "CJ7" Emblem, Self Adhesive NEW | DMC-5457017 |
| 1981-1986 CJ8, "CJ8" Emblem, Self Adhesive NEW | DMC-5758601 |



AUTHENTIC RESTORATION PRODUCT

Look for the star to check out all the Mopar Licensed Products

MOPAR, JEEP, DODGE, HEMI, PLYMOUTH, RAM, and CHRYSLER vehicles, images and logos are trademarks of Chrysler Group LLC used under license to Omix-Ada®, © Chrysler Group LLC 2011

1976-1983 CJ5, 1976-1986 CJ7, 1981-1986 CJ8 Body Parts

[O] 13320.11



[O] 13319.05



[O] 13317.01



[O] 13318.06



[O] 11813.11



[P] 12305.01



[P] 12303.02

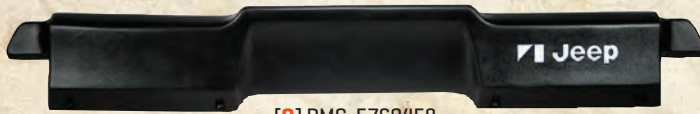

[O] DMC-5760458

O. Interior

Part#

| | |
|--|-------------|
| 1982-1983 CJ5, 1982-1986 CJ7, 1982-1986 CJ8, Jeep Script Dashpad, Black, With Moveable Vent Window | DMC-5760458 |
| 1982-1983 CJ5, 1982-1986 CJ7, 1982-1986 CJ8, Jeep Script Dashpad, Light Gray [Dyeable], With Moveable Vent Window | DMC-5760459 |
| 1976-1983 CJ5, 1976-1986 CJ7, 1981-1986 CJ8, Dashpad Screw Kit | 12029.32 |
| 1976-1983 CJ5, 1976-1986 CJ7, 1981-1986 CJ8, Dashpad Screw [8 Required] | 12029.31 |
| 1976-1983 CJ5, 1976-1986 CJ7, 1981-1986 CJ8, Dash Panel, Black, Blank [Without Holes] | 13320.10 |
| 1976-1983 CJ5, 1976-1986 CJ7, 1981-1986 CJ8, Dash Panel, Black, With Gauge Cutouts NEW | 13320.11 |
| 1976-1983 CJ5, 1976-1986 CJ7, 1981-1986 CJ8, Dash Panel, Black, With Gauge, Speaker & Radio Cutouts NEW | 13320.12 |
| 1976-1983 CJ5, 1976-1986 CJ7, 1981-1986 CJ8, Dash Panel, Stainless Steel, Blank [Without Holes] NEW | 11144.10 |
| 1976-1983 CJ5, 1976-1986 CJ7, 1981-1986 CJ8, Dash Panel, Stainless Steel, With Gauge Cutouts NEW | 11144.11 |
| 1976-1983 CJ5, 1976-1986 CJ7, 1981-1986 CJ8, Dash Panel, Stainless Steel, With Gauge, Speaker & Radio Cutouts NEW | 11144.12 |
| 1976-1983 CJ5, 1976-1986 CJ7, 1981-1986 CJ8, Dash Panel, Primered With Glove Box Hole | 13320.01 |
| 1976-1983 CJ5, 1976-1986 CJ7, 1981-1986 CJ8, Radio Delete Panel Hardware Kit | 13318.04 |
| 1976-1983 CJ5, 1976-1986 CJ7, 1981-1986 CJ8, Radio Delete Panel | 13318.03 |
| 1976-1983 CJ5, 1976-1986 CJ7, 1981-1986 CJ8, Torx Head Dash Bolt | 17258.01 |
| 1976-1983 CJ5, 1976-1986 CJ7, 1981-1986 CJ8, Dash Indicator Light Bezel Kit [6 Pieces] | 13319.01 |
| 1976-1983 CJ5, 1976-1986 CJ7, 1981-1986 CJ8, Dash Indicator Light Bezel "Lights" | 13319.02 |
| 1976-1983 CJ5, 1976-1986 CJ7, 1981-1986 CJ8, Dash Indicator Light Bezel "Wipers Washer" | 13319.03 |
| 1976-1983 CJ5, 1976-1986 CJ7, 1981-1986 CJ8, Dash Indicator Light Bezel "Air" | 13319.04 |
| 1976-1983 CJ5, 1976-1986 CJ7, 1981-1986 CJ8, Dash Indicator Light Bezel "Temp" | 13319.05 |
| 1976-1983 CJ5, 1976-1986 CJ7, 1981-1986 CJ8, Dash Indicator Light Bezel "Defrost" | 13319.06 |
| 1976-1983 CJ5, 1976-1986 CJ7, 1981-1986 CJ8, Dash Indicator Light Bezel "Fan" | 13319.07 |
| 1976-1983 CJ5, 1976-1986 CJ7, 1981-1986 CJ8, Heater & Wiper Switch Knob, Black | 13318.05 |
| 1976-1983 CJ5, 1976-1986 CJ7, 1981-1986 CJ8, Headlight Switch Knob, Black | 13318.06 |
| 1976-1983 CJ5, 1976-1986 CJ7, 1981-1986 CJ8, Turn Signal Lever | 13318.07 |
| 1976-1983 CJ5, 1976-1986 CJ7, 1981-1986 CJ8, Steering Column Cover, Black, Plastic | 13318.08 |
| 1976-1983 CJ5, 1976-1986 CJ7, 1981-1986 CJ8, Grab Bar Handle, Black | 11203.01 |
| 1976-1983 CJ5, 1976-1986 CJ7, 1981-1986 CJ8, Grab Bar Handle, Stainless Steel | 11123.01 |

O. Interior

Part#

| | |
|--|----------|
| 1976-1983 CJ5, 1976-1986 CJ7, 1981-1986 CJ8, Glove Box Door, Black | 11228.01 |
| 1976-1983 CJ5, 1976-1986 CJ7, 1981-1986 CJ8, Glove Box Door, Stainless Steel | 11125.01 |
| 1976-1983 CJ5, 1976-1986 CJ7, 1981-1986 CJ8, Glove Box Insert [Plastic] NEW | 13316.01 |
| 1976-1983 CJ5, 1976-1986 CJ7, 1981-1986 CJ8, Glove Box Release Button | 11813.11 |
| 1976-1983 CJ5, 1976-1986 CJ7, 1981-1986 CJ8, Glove Box Latch Bracket | 13317.01 |
| 1976-1986 CJ5, 1976-1986 CJ7, 1981-1986 CJ8, Rear View Mirror Kit [Includes Mirror, Button and Glue] | 11020.02 |
| 1976-1986 CJ5, 1976-1986 CJ7, 1981-1986 CJ8, Mirror Mounting Adhesive | 11021.01 |
| 1976-1986 CJ5, 1976-1986 CJ7, 1981-1986 CJ8 Window Crank Handle [With Full Steel Doors], LH or RH | 11814.01 |
| 1976-1983 CJ5, 1976-1986 CJ7, 1981-1986 CJ8, Door Handle Pull, Black LH or RH | 11801.01 |
| 1976-1986 CJ7, 1981-1986 CJ8, Sun Visor, Black, LH or RH | 13301.01 |
| 1976-1986 CJ7, 1981-1986 CJ8, Sun Visor, Gray, LH or RH | 13301.09 |
| 1976-1986 CJ7, 1981-1986 CJ8, Sun Visor, Charcoal, LH or RH | 13301.15 |
| 1976-1986 CJ7, 1981-1986 CJ8, 60" Seat Belt [Lap Belt], Black | 13202.04 |
| 1976-1986 CJ7, 1981-1986 CJ8, 60" Seat Belt [Lap Belt], Tan | 13202.20 |
| 1976-1986 CJ7, 1981-1986 CJ8, 60" Seat Belt [Lap Belt], Gray NEW | 13202.30 |
| 1976-1986 CJ7, 1981-1986 CJ8, 60" Seat Belt [Lap Belt], Olive Drab NEW | 13202.40 |
| 1976-1986 CJ7, 1981-1986 CJ8, 60" Seat Belt Retractable [Lap Belt], Black | 13202.02 |
| 1976-1986 CJ7, 1981-1986 CJ8, 60" Seat Belt Retractable [Lap Belt], Tan | 13202.21 |
| 1976-1986 CJ7, 1981-1986 CJ8, 60" Seat Belt Retractable [Lap Belt], Gray NEW | 13202.31 |
| 1976-1986 CJ7, 1981-1986 CJ8, 60" Seat Belt Retractable [Lap Belt], Olive Drab NEW | 13202.41 |
| 1976-1983 CJ5, 1976-1986 CJ7, 1981-1986 CJ8, 3-Point Seat Belt, Black | 13202.01 |
| 1976-1983 CJ5, 1976-1986 CJ7, 1981-1986 CJ8, 3-Point Seat Belt, Tan NEW | 13202.22 |
| 1976-1983 CJ5, 1976-1986 CJ7, 1981-1986 CJ8, 3-Point Seat Belt, Gray NEW | 13202.32 |
| 1976-1986 CJ7, 1981-1986 CJ8, Seatbelt Mount Round, For Lap Belt Floor Mount, 1/2-20 Bolt Hole | 13202.05 |
| 1976-1986 CJ7, 1981-1986 CJ8, Seatbelt Mount Oval, For Lap Belt Floor Mount, 1/2-20 Bolt Hole | 13202.06 |
| 1976-1986 CJ7, 1981-1986 CJ8, Seatbelt Mount Round, For Lap Belt Floor Mount, 7/16-20 Bolt Hole NEW | 13202.08 |
| 1976-1986 CJ7, 1981-1986 CJ8, Seat Belt Retractor [For Use With Lap Belts] | 13202.07 |
| 1976-1986 CJ7, Deluxe Carpet Kit, Black [6 Pieces, Includes Tailgate Carpet] | 13690.01 |
| 1976-1986 CJ7, Deluxe Carpet Kit, Gray [6 Pieces, Includes Tailgate Carpet] | 13690.09 |
| 1976-1986 CJ7, Deluxe Carpet Kit, Honey [6 Pieces, Includes Tailgate Carpet] | 13690.10 |

P. Weatherstrip

Part#

| | |
|--|----------|
| 1976-1983 CJ5, 1976-1986 CJ7, 1981-1986 CJ8, Windshield Weatherstrip | 12301.04 |
| 1976-1983 CJ5, 1976-1986 CJ7, 1981-1986 CJ8, Cowl Seal | 12302.03 |
| 1976-1986 CJ7, 1981-1986 CJ8, Hardtop Weatherstrip Kit [Hardtop to Body Seals] | 12304.07 |
| 1976-1986 CJ7, 1981-1986 CJ8, Hardtop to Windshield Frame Weatherstrip | 12304.04 |
| 1982-1983 CJ5, 1982-1986 CJ7, 1982-1986 CJ8, Door Seal Kit, With Hardtop & Moveable Vent Windows, Left [5 Piece Kit] NEW | 12303.51 |
| 1982-1983 CJ5, 1982-1986 CJ7, 1982-1986 CJ8, Door Seal Kit, With Hardtop & Moveable Vent Windows, Right [5 Piece Kit] NEW | 12303.50 |
| 1976-1981 CJ5, 1976-1981 CJ7, 1981 CJ8, Door Seal Kit, With Hardtop & Fixed Vent Windows, Left [5 Piece Kit] NEW | 12303.53 |
| 1976-1981 CJ5, 1976-1981 CJ7, 1981 CJ8, Door Seal Kit, With Hardtop & Fixed Vent Windows, Right [5 Piece Kit] | 12303.52 |
| 1976-1986 CJ7, 1981-1986 CJ8, Hardtop Side Window Seal, LH or RH | 12304.03 |
| 1976-1986 CJ7, 1981-1986 CJ8, Door Seal [For Full Steel Doors], Left | 12303.01 |
| 1976-1986 CJ7, 1981-1986 CJ8, Door Seal [For Full Steel Doors], Right | 12303.02 |
| 1976-1986 CJ7, Liftgate Outer Glass Seal | 12304.01 |
| 1976-1986 CJ7, Liftgate Inner Glass Seal | 12304.02 |
| 1976-1986 CJ7, 1981-1986 CJ8, Tailgate Seal | 12305.01 |
| 1976-1983 CJ5, 1976-1986 CJ7, 1981-1986 CJ8, Grille to Hood Grommet [Bumper] [4 Required] | 12029.01 |

All images are subject to be representative. More detailed information is available online.



[C] 12033.01

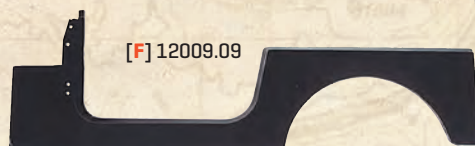

[F] 12009.09



[E] 12004.16



[B] 12217.03



AUTHENTIC RESTORATION PRODUCTS

MOPAR, JEEP, DODGE, RAM, PLYMOUTH, RAM, and CHRYSLER vehicles, images and logos are trademarks of Chrysler Group LLC used under license to Omix-Ada®. © Chrysler Group LLC 2011

Look for the star to check out all the Mopar Licensed Products



[G] 12006.09



[D] 12003.06

[D] 11210.08



A. Steel Body Tubs Part#

| | |
|---|--------------|
| 1987-1995 Wrangler, Body Tub, With Jeep Script Stamped In Cowl Sides NEW | DMC-55050500 |
|---|--------------|

B. Body Mounting Hardware Part#

| | |
|---|----------|
| 1987-1995 Wrangler, Body Mounting Washer Kit [8 Pieces] | 12217.03 |
| 1987-1995 Wrangler, Body Fastener Kit, With Soft Top [703 Pieces] | 12215.12 |
| 1987-1995 Wrangler, Body Fastener Kit, With Hardtop [754 Pieces] | 12215.11 |

C. Grille Covers (Genuine Mopar) Part#

| | |
|---|----------|
| 1987-1995 Wrangler, Grille Overlay [Applique], Chrome | 12033.06 |
| 1997-2006 Wrangler, 2004-2006 Wrangler Unlimited, Grille Overlay [Applique], Chrome | 12033.01 |
| 2007-2012 Wrangler & Wrangler Unlimited, Grille Overlay [Applique], Chrome | 12033.05 |

D. Hood & Components Part#

| | |
|---|----------|
| 1987-1995 Wrangler, Hood | 12003.06 |
| 1998-2000 Wrangler, Hood [Before 02/07/00], With Dual Wiper Nozzle Holes | 12003.07 |
| 2000-2006 Wrangler, 2004-2006 Wrangler Unlimited, Hood [After 02/07/00], With Single Wiper Nozzle Hole | 12003.08 |
| 2007-2012 Wrangler & Wrangler Unlimited, Hood NEW | 12040.01 |
| 1997-2006 Wrangler, 2004-2006 Wrangler Unlimited, Hood Catch Kit, Includes: Catch and Bracket [pair] | 11210.09 |
| 1997-2006 Wrangler, 2004-2006 Wrangler Unlimited, Hood Catch Kit, Includes: Catch and Bracket [Does One Side] | 11210.08 |
| 1997-2006 Wrangler, 2004-2006 Wrangler Unlimited, Hood Catch, Black, LH or RH | 11210.07 |
| 1987-1995 Wrangler, Hood Hinge Bolt | 12029.30 |

E. Fenders & Components Part#

| | |
|---|----------|
| 1987-1995 Wrangler, Fender, Left | 12004.13 |
| 1987-1995 Wrangler, Fender, Right | 12004.14 |
| 1997-2006 Wrangler, 2004-2006 Wrangler Unlimited, Fender, Left | 12004.15 |
| 1997-2006 Wrangler, 2004-2006 Wrangler Unlimited, Fender, Right | 12004.16 |
| 2007-2012 Wrangler & Wrangler Unlimited, Fender, Right NEW | 12040.02 |
| 2007-2012 Wrangler & Wrangler Unlimited, Fender, Left NEW | 12040.03 |

F. Body Panels Part#

| | |
|---|-------------|
| 1987-1995 Wrangler, Side [Quarter] Panel, Left | 12009.09 |
| 1987-1995 Wrangler, Side Panel With Jeep Script, Left NEW | DMC-8133339 |
| 1987-1995 Wrangler, Side [Quarter] Panel, Right | 12009.10 |
| 1987-1995 Wrangler, Side Panel With Jeep Script, Right NEW | DMC-8133338 |
| 1987-1995 Wrangler, Wheel Housing, Rear, Right | 12029.16 |
| 1987-1995 Wrangler, Wheel Housing, Rear, Left | 12029.15 |

G. Windshield Frame & Components Part#

| | |
|---|----------|
| 1987-1995 Wrangler, Windshield | 12006.09 |
| 1997-2002 Wrangler, Windshield | 12006.10 |
| 2003-2006 Wrangler, 2004-2006 Wrangler Unlimited Windshield | 12006.11 |
| 1987-1995 Wrangler, Windshield Hinge Screw [16 Required] | 12029.06 |
| 1987-2006 Wrangler, 2004-2006 Wrangler Unlimited, Windshield Tie Down Strap | 11825.20 |



[D] 11210.09



[I] 12031.10



[H] 12005.06



[I] 11215.01

H. Tailgates Part#

| | |
|--|----------|
| 1987-1995 Wrangler, Tailgate | 12005.06 |
| 1997-2006 Wrangler, 2004-2006 Wrangler Unlimited, Tailgate | 12005.07 |
| 1987-1995 Wrangler, Tailgate Handle, Black | 11812.08 |
| 1997-2006 Wrangler, 2004-2006 Wrangler Unlimited, Tailgate Handle, Black | 11812.10 |
| 1991-1994 Wrangler, Tailgate Lock Cylinder, With Key NEW | 11813.09 |
| 1995 Wrangler, Tailgate Lock Cylinder, With Key | 11813.10 |
| 1997 Wrangler, Tailgate Lock Cylinder, With Key | 11813.10 |
| 1998-2002 Wrangler, Tailgate Lock Cylinder, With Key | 11813.04 |
| 2003-2006 Wrangler, 2004-2006 Wrangler Unlimited, Tailgate Lock Cylinder, With Key | 11813.05 |

I. Bumpers & Components Part#

| | |
|--|----------|
| 1987-1995 Wrangler, Front Bumper, OE Style | 12031.03 |
| 1987-1995 Wrangler, Front Bumper Extensions [Pair] | 12031.04 |
| 1987-1995 Wrangler, Rear Bumperettes [Pair] | 11215.01 |
| 1997-2006 Wrangler, 2004-2006 Wrangler Unlimited, Front Bumper, OE Style | 12033.02 |
| 1997-2006 Wrangler, 2004-2006 Wrangler Unlimited, Front Bumper, Stainless Steel, OE Style | 11107.05 |
| 1997-2006 Wrangler, 2004-2006 Wrangler Unlimited, Front Bumper Extension, Left | 12031.07 |
| 1997-2006 Wrangler, 2004-2006 Wrangler Unlimited, Front Bumper Extension, Right | 12031.08 |
| 1997-2006 Wrangler, 2004-2006 Wrangler Unlimited, Rear Bumper, OE Style | 12033.03 |
| 1997-2006 Wrangler, 2004-2006 Wrangler Unlimited, Rear Bumper, Stainless Steel, OE Style | 11107.06 |
| 1997-2006 Wrangler, 2004-2006 Wrangler Unlimited, Rear Bumper Extension, Left | 12031.09 |
| 1997-2006 Wrangler, 2004-2006 Wrangler Unlimited, Rear Bumper Extension, Right | 12031.10 |
| 1997-2006 Wrangler, 2004-2006 Wrangler Unlimited, Bumper Extension Screw, Front or Rear [4 Required Per Extension] | 12032.01 |
| 2007-2012 Wrangler & Wrangler Unlimited, Front Bumper Cover, With Fog Light NEW | 12040.05 |



[J] 11602.01



[K] 11002.03



[K] 11813.03



[K] 11810.02



[L] 11251.02



[L] 12306.04



[L] 12012.17



J. Fender Flares

| Part# | Description |
|----------|--|
| 11602.01 | 1987-1995 Wrangler, Fender Flare Kit, Includes: 4 Flares, 2 Fender Extensions & Hardware Kit |
| 11602.02 | 1987-1995 Wrangler, Fender Flare Kit, Includes: 4 Flares & Hardware Kit |
| 11602.03 | 1987-1995 Wrangler, Fender Flare, Front, Left |
| 11602.04 | 1987-1995 Wrangler, Fender Flare, Front, Right |
| 11602.05 | 1987-1995 Wrangler, Fender Flare, Rear, Left |
| 11602.06 | 1987-1995 Wrangler, Fender Flare, Rear, Right |
| 11602.07 | 1987-1995 Wrangler, Fender Flare Extension, Front, Left |
| 11602.08 | 1987-1995 Wrangler, Fender Flare Extension, Front, Right |
| 11601.06 | 1987-1995 Wrangler, Fender Flare Hardware Kit |
| 11602.09 | 1987-1995 Wrangler, Fender Extension Bracket, Front, LH or RH |
| 11603.01 | 1997-2006 Wrangler, 2004-2006 Wrangler Unlimited, Fender Flare Kit, Includes: 4 Flares, 2 Fender Extensions & Hardware Kit |
| 11603.02 | 1997-2006 Wrangler, 2004-2006 Wrangler Unlimited, Fender Flare Kit, Includes: 4 Flares |
| 11603.03 | 1997-2006 Wrangler, 2004-2006 Wrangler Unlimited, Fender Flare, Front, Left |
| 11603.04 | 1997-2006 Wrangler, 2004-2006 Wrangler Unlimited, Fender Flare, Front, Right |
| 11603.05 | 1997-2006 Wrangler, 2004-2006 Wrangler Unlimited, Fender Flare, Rear, Left |
| 11603.06 | 1997-2006 Wrangler, 2004-2006 Wrangler Unlimited, Fender Flare, Rear, Right |
| 11603.07 | 1997-2006 Wrangler, 2004-2006 Wrangler Unlimited, Fender Flare Extension, Front, Left |
| 11603.08 | 1997-2006 Wrangler, 2004-2006 Wrangler Unlimited, Fender Flare Extension, Front, Right |
| 11603.09 | 1997-2006 Wrangler, 2004-2006 Wrangler Unlimited, Fender Flare Hardware Kit |
| 11609.01 | 2007-2012 Wrangler & Wrangler Unlimited, Fender Flare Kit* NEW |
| 11609.11 | 2007-2012 Wrangler & Wrangler Unlimited, Fender Flare, Front, Left* NEW |
| 11609.10 | 2007-2012 Wrangler & Wrangler Unlimited, Fender Flare, Front, Right* NEW |
| 11609.13 | 2007-2012 Wrangler & Wrangler Unlimited, Fender Flare, Rear, Left* NEW |
| 11609.12 | 2007-2012 Wrangler & Wrangler Unlimited, Fender Flare, Rear, Right* NEW |

* Except Sahara

K. Body Accessories

| Part# | Description |
|----------|---|
| 11002.03 | 1987-2002 Wrangler (With Half Doors), 1994-2002 Wrangler With Full Steel Doors, Mirrors, Black [Pair] |
| 11005.08 | 1987-2002 Wrangler (With Half Doors), 1994-2002 Wrangler With Full Steel Doors, Mirrors, Stainless Steel [Pair] |
| 11002.09 | 2003-2006 Wrangler, 2004-2006 Wrangler Unlimited, Mirrors, Black [Pair] |
| 11812.05 | 1987-1995 Wrangler, Door Paddle Handle (With Full Steel Doors), Black, Left |
| 11002.21 | 2007-2012 Wrangler & Wrangler Unlimited, Mirrors, Black [Pair] NEW |
| 11812.06 | 1987-1995 Wrangler, Door Paddle Handle (With Full Steel Doors), Black, Right |
| 11812.03 | 1987-1995 Wrangler, Door Paddle Handle (With Full Steel Doors), Chrome, Left |
| 11812.04 | 1987-1995 Wrangler, Door Paddle Handle (With Full Steel Doors), Chrome, Right |
| 11812.06 | 1997-2006 Wrangler, 2004-2006 Wrangler Unlimited, Door Paddle Handle (With Full Steel Doors), Black, Left |
| 11812.05 | 1997-2006 Wrangler, 2004-2006 Wrangler Unlimited, Door Paddle Handle (With Full Steel Doors), Black, Right |
| 11812.04 | 1997-2006 Wrangler, 2004-2006 Wrangler Unlimited, Door Paddle Handle (With Full Steel Doors), Chrome, Left |
| 11812.03 | 1997-2006 Wrangler, 2004-2006 Wrangler Unlimited, Door Paddle Handle (With Full Steel Doors), Chrome, Right |
| 11812.08 | 1987-2006 Wrangler, 2004-2006 Wrangler Unlimited, Door Handle, With Half Doors, Black, Right |
| 11812.09 | 1987-2006 Wrangler, 2004-2006 Wrangler Unlimited, Door Handle, With Half Doors, Black, Left |
| 11810.01 | 1987-1995 Wrangler, Door Latch Bracket (With Full Steel Doors), Black, Left |
| 11810.02 | 1987-1995 Wrangler, Door Latch Bracket (With Full Steel Doors), Black, Right |
| 11810.03 | 1987-1995 Wrangler, Door Latch Bracket (With Full Steel Doors), Stainless Steel, Left |
| 11810.04 | 1987-1995 Wrangler, Door Latch Bracket (With Full Steel Doors), Stainless Steel, Right |
| 11810.05 | 1987-1995 Wrangler, Door Latch Bracket Set (With Full Steel Doors), Stainless Steel, pair |
| 11811.01 | 1987-1995 Wrangler, Door Latch Striker Plate (With Full Steel Doors), LH or RH |
| 11811.02 | 1987-1995 Wrangler, Door Latch Striker Pin, LH or RH |
| 11813.03 | 1991-1994 Wrangler, Door Lock Cylinder, With Key, LH or RH NEW |
| 11813.04 | 1995-2002 Wrangler, Door Lock Cylinder, With Key, LH or RH |
| 11105.01 | 1987-2006 Wrangler, 2004-2006 Wrangler Unlimited, Footman Loop Kit, Stainless Steel |

L. Top Components

| Part# | Description |
|----------|--|
| 11251.01 | 1987-1995 Wrangler, Soft Top Spreader Bar, OE Replacement |
| 11251.02 | 1987-1995 Wrangler, Ultimate Adjustable Spreader Bar, OE Replacement |
| 12306.03 | 1987-1995 Wrangler, Soft Top Windshield Retainer, Left |
| 12306.04 | 1987-1995 Wrangler, Soft Top Windshield Retainer, Right |
| 12306.08 | 1987-1995 Wrangler, Soft Top Door Seal Clip, Left |
| 12306.07 | 1987-1995 Wrangler, Soft Top Snaps |
| 12012.01 | 1987-1995 Wrangler, Liftgate Support Strut (Shock), LH or RH |
| 12012.02 | 1997-2005 Wrangler, 2004-2005 Wrangler Unlimited, Liftgate Support Strut (Shock), LH or RH |
| 12012.17 | 2006-2012 Wrangler & Wrangler Unlimited, Liftgate Support Strut (Shock), LH or RH |

Body kits, body tubs and body parts are sold "As Is". See Limited Warranty Information inside back cover. Drilling, cutting and other modifications may be required for proper installation. Claims for freight damage must be placed with freight carriers.

All images are subject to be representative. More detailed information is available online.



[M] 13691.01



[M] 11816.01



[M] 13312.01



[M] 11818.09



[M] 13202.31



[N] 12304.05



[N] 12301.05

M. Interior

Part#

| | |
|---|----------|
| 1987-1995 Wrangler, Deluxe Carpet Kit, Black [6 Pieces, Includes Tailgate Carpet] | 13690.01 |
| 1987-1995 Wrangler, Deluxe Carpet Kit, Gray [6 Pieces, Includes Tailgate Carpet] | 13690.09 |
| 1987-1995 Wrangler, Deluxe Carpet Kit, Honey [6 Pieces, Includes Tailgate Carpet] | 13690.10 |
| 1997-2006 Wrangler, Deluxe Carpet Kit, Black [6 Pieces, Includes Tailgate Carpet] | 13691.01 |
| 1997-2006 Wrangler, Deluxe Carpet Kit, Gray [6 Pieces, Includes Tailgate Carpet] | 13691.09 |
| 1997-2006 Wrangler, Deluxe Carpet Kit, Honey [6 Pieces, Includes Tailgate Carpet] | 13691.10 |
| 1987-1995 Wrangler, Torx Head Dash Bolt | 17258.01 |
| 1987-1991 Wrangler, Window Crank Handle [With Full Steel Doors], LH or RH | 11814.01 |
| 1987-1995 Wrangler, Interior Door Handle Pull Kit, Black [Does One Side], Full or Half Doors | 11816.01 |
| 1987-1995 Wrangler, Interior Door Handle Pull Kit, Spice [Does One Side], Full or Half Doors | 11816.37 |
| 1987-1995 Wrangler, Interior Door Handle Pull Kit, Gray [Does One Side], Full or Half Doors | 11816.09 |
| 1987-1995 Wrangler, Interior Door Handle, Full or Half Doors, Left | 11812.13 |
| 1987-1995 Wrangler, Interior Door Handle, Full or Half Doors, Right | 11812.12 |
| 1987-1995 Wrangler, Door Limiting Strap, Black, LH or RH | 11817.01 |
| 1987-1995 Wrangler, Adjustable Door Limiting Straps, Black [Pair] | 12103.01 |
| 1987-2006 Wrangler, 2004-2006 Wrangler Unlimited, Door Panel Insert, With Half Doors, Black [6 Required] | 11818.01 |
| 1987-2006 Wrangler, 2004-2006 Wrangler Unlimited, Door Panel Insert, With Half Doors, Gray [6 Required] | 11818.09 |
| 1987-2006 Wrangler, 2004-2006 Wrangler Unlimited, Door Panel Insert, With Half Doors, Spice [6 Required] | 11818.37 |
| 1987-2012 Wrangler, 2004-2012 Wrangler Unlimited, Rear View Mirror Kit [Includes Mirror, Button & Adhesive] | 11020.02 |
| 1987-2012 Wrangler, 2004-2012 Wrangler Unlimited, Rear View Mirror Glue | 11021.01 |
| 1987-1995 Wrangler, 60" Seat Belt [Lap Belt], Black | 13202.04 |
| 1987-1995 Wrangler, 60" Seat Belt [Lap Belt], Tan NEW | 13202.20 |
| 1987-1995 Wrangler, 60" Seat Belt [Lap Belt], Gray NEW | 13202.30 |
| 1987-1995 Wrangler, 60" Seat Belt [Lap Belt], Olive Drab NEW | 13202.40 |
| 1987-1995 Wrangler, 60" Seat Belt Retractable [Lap Belt], Black | 13202.02 |
| 1987-1995 Wrangler, 60" Seat Belt Retractable [Lap Belt], Tan NEW | 13202.21 |
| 1987-1995 Wrangler, 60" Seat Belt Retractable [Lap Belt], Gray NEW | 13202.31 |
| 1987-1995 Wrangler, 60" Seat Belt Retractable [Lap Belt], Olive Drab NEW | 13202.41 |
| 1987-1995 Wrangler, 3-Point Seat Belt, Black | 13202.01 |
| 1987-1995 Wrangler, 3-Point Seat Belt, Tan NEW | 13202.22 |
| 1987-1995 Wrangler, 3-Point Seat Belt, Gray NEW | 13202.32 |
| Seat Belt 3Point Retrac Olive NEW | 13202.42 |
| 1987-1995 Wrangler, Seatbelt Mount Round, For Lap Belt Floor Mount, 1/2-20 Bolt Hole | 13202.05 |
| Seatbelt Mount Oval, For Lap Belt Floor Mount, 1/2-20 Bolt Hole | 13202.06 |
| 1987-1995 Wrangler, Seatbelt Mount Round, For Lap Belt Floor Mount, 7/16-20 Bolt Hole NEW | 13202.08 |
| 1987-1995 Wrangler, Sun Visor, Black, Pair | 13312.01 |
| 1987-1995 Wrangler, Sun Visor, Gray, Pair | 13312.09 |
| 1987-1995 Wrangler, Sun Visor, Charcoal, Pair | 13312.15 |
| 1987-1995 Wrangler, Sun Visor, Spice, Pair | 13312.37 |

N. Weatherstrip

Part#

| | |
|---|----------|
| 1987-1995 Wrangler, Windshield Weatherstrip, Inner Glass Seal | 12301.05 |
| 1987-1995 Wrangler, Windshield Weatherstrip, Outer Glass Seal | 12301.06 |
| 1987-1995 Wrangler, Windshield Weatherstrip Clip | 12301.07 |
| 1997-2006 Wrangler, 2004-2006 Wrangler Unlimited, Windshield Weatherstrip, Inner | 12301.09 |
| 1997-2006 Wrangler, 2004-2006 Wrangler Unlimited, Windshield Weatherstrip, Outer | 12301.08 |
| 1987-1995 Wrangler, Cowl Seal | 12302.04 |
| 1997-2002 Wrangler, Cowl Seal | 12302.05 |
| 1987-1995 Wrangler, Hood Grommet [2 Required] | 12031.01 |
| 1987-2006 Wrangler, 2004-2006 Wrangler Unlimited, Hood to Fender Grommet [2 Required] | 12031.02 |
| 1987-1995 Wrangler, Door Seal Kit, With Hardtop & Moveable Vent Windows, Left [5 Piece Kit] NEW | 12303.51 |
| 1987-1995 Wrangler, Door Seal Kit, With Hardtop & Moveable Vent Windows, Right [5 Piece Kit] NEW | 12303.50 |
| 1987-1995 Wrangler, Door Seal [For Half Doors], Left | 12303.03 |
| 1987-1995 Wrangler, Door Seal [For Half Doors], Right | 12303.04 |
| 1987-1995 Wrangler, Door Seal [For Full Steel Doors], Left | 12303.01 |
| 1987-1995 Wrangler, Door Seal [For Full Steel Doors], Right | 12303.02 |
| 1987-1995 Wrangler, Door Edge Seal [For Full Steel Doors], Front, LH or RH | 12303.10 |
| 1987-1995 Wrangler, Door Window Rear Seal [For Full Steel Doors], Rear, LH or RH | 12303.05 |
| 1987-1995 Wrangler, Door Inner Glass Seal [For Full Steel Doors], Left | 12303.09 |
| 1987-1995 Wrangler, Door Inner Glass Seal [For Full Steel Doors], Right | 12303.08 |
| 1987-1995 Wrangler, Door Outer Glass Seal [For Full Steel Doors], Left | 12303.07 |
| 1987-1995 Wrangler, Door Outer Glass Seal [For Full Steel Doors], Right | 12303.06 |
| 1997-2006 Wrangler, 2004-2006 Wrangler Unlimited, Door Seal [For Half Doors], Left | 12303.15 |
| 1997-2006 Wrangler, 2004-2006 Wrangler Unlimited, Door Seal [For Half Doors], Right | 12303.14 |
| 1997-2006 Wrangler, 2004-2006 Wrangler Unlimited, Door Seal [For Full Steel Doors], Left | 12303.13 |
| 1997-2006 Wrangler, 2004-2006 Wrangler Unlimited, Door Seal [For Full Steel Doors], Right | 12303.12 |
| 1987-1995 Wrangler, Hardtop to Windshield Frame Weatherstrip | 12304.04 |
| 1987-1995 Wrangler, Hardtop Weatherstrip Kit [Hardtop to Body Seals] | 12304.07 |
| 1987-1995 Wrangler, Hardtop Corner Seal, Left | 12304.05 |
| 1987-1995 Wrangler, Hardtop Corner Seal, Right | 12304.06 |
| 1987-1995 Wrangler, Rear Lift Gate Glass Weatherstrip | 12304.08 |
| 1987-1995 Wrangler, Tailgate Seal | 12305.02 |
| 1997-2006 Wrangler, 2004-2006 Wrangler Unlimited, Tailgate Seal | 12305.03 |
| 1997-2006 Wrangler, 2004-2006 Wrangler Unlimited, Tailgate Seal Upper | 12304.09 |
| 1987-1995 Wrangler, Floor Pan Grommet [11 Required] | 12031.05 |



1984-2001 Cherokee Body Parts



| A. Hoods | Part# |
|--------------------------|----------|
| 1984-1986 Cherokee, Hood | 12035.01 |
| 1987-1996 Cherokee, Hood | 12035.02 |
| 1997-2001 Cherokee, Hood | 12035.03 |

| B. Fenders | Part# |
|-----------------------------------|----------|
| 1984-1996 Cherokee, Fender, Right | 12035.04 |
| 1984-1996 Cherokee, Fender, Left | 12035.05 |
| 1997-2001 Cherokee, Fender, Right | 12035.06 |
| 1997-2001 Cherokee, Fender, Left | 12035.07 |

| C. Grilles | Part# |
|---|----------|
| 1984-1987 Cherokee, Grille, Black | 12035.28 |
| 1984-1987 Cherokee, Grille, Black With Paintable Accent | 12035.25 |
| 1984-1987 Cherokee, Grille, Black With Chrome Accent | 12035.26 |
| 1988-1990 Cherokee, Grille, Black With Black Accent | 12035.27 |
| 1991-1996 Cherokee, Grille, Black With Chrome Accent | 12035.30 |
| 1993-1996 Cherokee, Grille, Black | 12035.29 |
| 1997-2001 Cherokee Sport & SE, Grille, Black | 12035.32 |
| 1997-2001 Cherokee Country, Grille, Black | 12035.31 |
| 1984-1990 Cherokee, Header Panel | 12035.22 |
| 1991-1996 Cherokee, Header Panel | 12035.23 |
| 1997-2001 Cherokee, Header Panel | 12035.24 |

| D. Bumpers & Components | Part# |
|---|----------|
| 1984-1996 Cherokee, Front Bumper, Black | 12035.40 |
| 1984-1996 Cherokee, Front Bumper, Chrome | 12035.42 |
| 1984-1996 Cherokee, Front Bumper Guard, Left | 12035.35 |
| 1984-1996 Cherokee, Front Bumper Guard, Right | 12035.34 |
| 1984-1996 Cherokee, Front Bumper Extension [End Cap], Left | 12035.47 |
| 1984-1996 Cherokee, Front Bumper Extension [End Cap], Right | 12035.46 |
| 1984-1996 Cherokee, Rear Bumper, Black | 12035.41 |
| 1984-1996 Cherokee, Rear Bumper, Chrome | 12035.43 |
| 1984-1996 Cherokee, Rear Bumper Guard, Left | 12035.37 |
| 1984-1996 Cherokee, Rear Bumper Guard, Right | 12035.36 |
| 1984-1996 Cherokee, Rear Bumper Extension [End Cap], Left | 12035.49 |
| 1984-1996 Cherokee, Rear Bumper Extension [End Cap], Right | 12035.48 |
| 1984-1996 Cherokee, Rear Bumper Bracket, Front or Rear | 12035.55 |
| 1997-2001 Cherokee, Front Bumper, Black | 12035.44 |
| 1997-2001 Cherokee, Front Bumper, Chrome | 12035.61 |
| 1997-2001 Cherokee, Rear Bumper, Black | 12035.45 |
| 1997-2001 Cherokee, Rear Bumper, Chrome | 12035.62 |

| E. Fender Flares | Part# |
|--|----------|
| 1984-1996 Cherokee, Fender Flare Kit [4 Piece] | 11605.01 |
| 1984-1996 Cherokee, Fender Flare, Front, Left | 11605.03 |
| 1984-1996 Cherokee, Fender Flare, Front, Right | 11605.02 |
| 1984-1996 Cherokee, Fender Flare, Rear, Left | 11605.05 |
| 1984-1996 Cherokee, Fender Flare, Rear, Right | 11605.04 |

| F. Body Accessories | Part# |
|--|----------|
| 1984-1996 Cherokee, Outer Door Handle, Black, Front or Rear, left | 12035.39 |
| 1984-1996 Cherokee, Outer Door Handle, Black, Front or Rear, Right | 12035.38 |
| 1991-1994 Cherokee, Door Lock Cylinder, With Key, LH or RH NEW | 11813.03 |
| 1995-1997 Cherokee, Door Lock Cylinder, With Key, LH or RH | 11813.04 |
| 1997-2001 Cherokee, Door Lock Cylinder, With Key, LH or RH | 11813.05 |
| 1984-1996 Cherokee, Mirror, Black, Folding, Non-Remote, Non-Power, Left | 12035.09 |
| 1984-1996 Cherokee, Mirror, Black, Folding, Non-Remote, Non-Power, Right | 12035.08 |
| 1984-1996 Cherokee, Mirror, Black, Folding, Remote, Non-Power, Left | 12035.11 |
| 1984-1996 Cherokee, Mirror, Black, Folding, Remote, Non-Power, Right | 12035.10 |
| 1984-1996 Cherokee, Mirror, Black, Folding, Remote, Power, Left | 12035.13 |
| 1984-1996 Cherokee, Mirror, Black, Folding, Remote, Power, Right | 12035.12 |
| 1984-1996 Cherokee, Mirror, Chrome, Folding, Remote, Non-Power, Left | 12035.15 |
| 1984-1996 Cherokee, Mirror, Chrome, Folding, Remote, Non-Power, Right | 12035.14 |
| 1997-2001 Cherokee, Mirror, Black, Folding, Remote, Non-Power, Left | 12035.17 |
| 1997-2001 Cherokee, Mirror, Black, Folding, Remote, Non-Power, Right | 12035.16 |
| 1997-2001 Cherokee, Mirror, Black, Folding, Remote, Power, Left | 12035.19 |
| 1997-2001 Cherokee, Mirror, Black, Folding, Remote, Power, Right | 12035.18 |
| 1997-2001 Cherokee, Mirror, Black, Folding, Remote, Power, Heated, Left | 12035.21 |
| 1997-2001 Cherokee, Mirror, Black, Folding, Remote, Power, Heated, Right | 12035.20 |
| 1984-1994 Cherokee, Liftgate Support Strut [Shock] LH or RH | 12012.03 |
| 1995-1996 Cherokee, Liftgate Support Strut [Shock] LH or RH | 12012.04 |
| 1997-2001 Cherokee, Liftgate Support Strut [Shock] LH or RH | 12012.05 |

| G. Interior | Part# |
|---|----------|
| 1984-2001 Cherokee, Rear View Mirror Kit [Includes Mirror, Button and Glue] | 11020.02 |
| 1984-2001 Cherokee, Rear View Mirror Glue | 11021.01 |
| 1984-1986 Cherokee, Dual Cup Holder NEW | 12035.50 |
| 1984-1995 Cherokee, Floor Pan Grommet [11 Required] | 12031.05 |

| H. Crossmembers & Braces | Part# |
|--|----------|
| 1984-2001 Cherokee, Heavy Duty Transfer Case Crossmember | 12035.60 |
| 1984-2001 Cherokee, Heavy Duty Steering Box Brace | 18021.05 |

| I. Weatherstrip | Part# |
|---|----------|
| 1984-1996 Cherokee, Door Seal, Front or Rear Door, LH or RH | 12303.69 |
| 1984-1996 Cherokee, Inner Glass Seal, Front Door, Left | 12303.67 |
| 1984-1996 Cherokee, Inner Glass Seal, Front Door, Right | 12303.66 |
| 1984-1996 Cherokee, Outer Glass Seal, Front Door, Left | 12303.73 |
| 1984-1996 Cherokee, Outer Glass Seal, Front Door, Right | 12303.72 |
| 1984-1996 Cherokee, Door Glass Run Weatherstrip, Front Door, Left | 12303.75 |
| 1984-1996 Cherokee, Door Glass Run Weatherstrip, Front Door, Right | 12303.74 |
| 1984-1996 Cherokee, Door Belt Seal, Front Position, Rear Door, LH or RH | 12303.61 |
| 1984-1996 Cherokee, Door Belt Seal, Rear Position, Rear Door, LH or RH | 12303.64 |
| 1984-1996 Cherokee, Door Glass Run Weatherstrip, Rear Door, Left | 12303.63 |
| 1984-1996 Cherokee, Door Glass Run Weatherstrip, Rear Door, Right | 12303.62 |
| 1984-1996 Cherokee, Inner Glass Seal, Rear Door, Left | 12303.71 |
| 1984-1996 Cherokee, Inner Glass Seal, Rear Door, Right | 12303.70 |
| 1984-2001 Cherokee, Liftgate Weatherstrip | 12303.68 |

All images are subject to be representative. More detailed information is available online.



[A] 12037.01



[C] 12037.13



[F] 12037.23



[D] 12037.11

[E] 12037.08

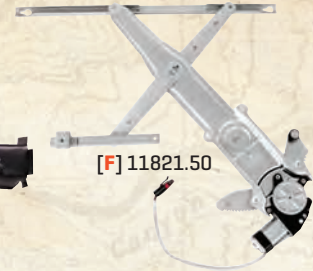

[F] 11821.50



[B] 12037.03



[F] 12039.08



[F] 11813.05



[A] 12012.11

| A. Hoods | Part# |
|--|----------|
| 1993-1998 Grand Cherokee, Hood | 12037.01 |
| 1999-2004 Grand Cherokee, Hood | 12039.01 |
| 2005-2010 Grand Cherokee, Hood NEW | 12041.01 |
| 1999-2003 Grand Cherokee, Hood Support Strut (Shock) LH or RH | 12012.11 |
| 2004 Grand Cherokee, Hood Support Strut (Shock) LH or RH | 12012.12 |
| 2005-2010 Grand Cherokee, Hood Support Strut (Shock) LH or RH NEW | 12012.14 |

| B. Fenders | Part# |
|--|----------|
| 1993-1998 Grand Cherokee, Fender, Left | 12037.03 |
| 1993-1998 Grand Cherokee, Fender, Right | 12037.02 |
| 1999-2004 Grand Cherokee, Fender, Left | 12039.03 |
| 1999-2004 Grand Cherokee, Fender, Right | 12039.02 |
| 2005-2010 Grand Cherokee, Fender, Left NEW | 12041.03 |
| 2005-2010 Grand Cherokee, Fender, Right NEW | 12041.02 |

| C. Grilles | Part# |
|---|----------|
| 1993-1995 Grand Cherokee, Grille, Black | 12037.13 |
| 1993-1995 Grand Cherokee, Grille, Chrome | 12037.12 |
| 1996-1998 Grand Cherokee, Grille, Dark Argent | 12037.15 |
| 1996-1998 Grand Cherokee, Grille, Chrome | 12037.14 |
| 1999-2003 Grand Cherokee, Grille, Black | 12039.05 |
| 1999-2003 Grand Cherokee, Grille, Chrome NEW | 12037.26 |
| 1993-1995 Grand Cherokee, Header Panel | 12037.04 |
| 1996-1998 Grand Cherokee, Header Panel | 12037.05 |
| 1999-2003 Grand Cherokee, Header Panel | 12039.04 |

| D. Bumpers & Components | Part# |
|--|----------|
| 1996-1996 Grand Cherokee Base, Laredo, Sport TSi, Front Bumper Cover, Without Fog Lights | 12037.28 |
| 1996-1996 Grand Cherokee Base, Laredo, Sport TSi, Front Bumper Cover, With Fog Lights | 12037.29 |
| 1993-1998 Grand Cherokee Laredo, Rear Bumper Cover | 12037.11 |
| 1993-1998 Grand Cherokee Limited, Rear Bumper Cover | 12037.10 |
| 1999-2003 Grand Cherokee Laredo, Front Bumper Cover, Without Fog Lights, Dark Gray | 12039.20 |
| 1999-2003 Grand Cherokee Laredo, Front Bumper Cover, With Fog Lights, Dark Gray | 12039.21 |
| 1999-2003 Grand Cherokee Laredo, Front Bumper Cover, With Fog Lights, Dark Brownstone | 12039.22 |
| 1999-2000 Grand Cherokee Limited, Front Bumper Cover | 12039.23 |
| 2001-2003 Grand Cherokee Limited, Front Bumper Cover | 12039.24 |
| 2005-2007 Grand Cherokee Limited & Overland, Front Bumper Cover, Without Chrome Insert | 12041.05 |
| 2005-2007 Grand Cherokee Limited & Overland, Front Bumper Cover, With Chrome Insert | 12041.06 |

| E. Crossmembers & Braces | Part# |
|--|----------|
| 1993-1998 Grand Cherokee, Front Crossmember | 12037.08 |
| 1993-1998 Grand Cherokee, Lower Radiator Support Crossmember | 12037.09 |

| F. Body Accessories | Part# |
|--|----------|
| 1993-1998 Grand Cherokee, Exterior Door Handle, Front, Left | 12037.23 |
| 1993-1998 Grand Cherokee, Exterior Door Handle, Front, Right | 12037.22 |
| 1993-1998 Grand Cherokee, Exterior Door Handle, Rear, Left | 12037.25 |
| 1993-1998 Grand Cherokee, Exterior Door Handle, Rear, Right | 12037.24 |
| 1991-1994 Grand Cherokee, Door Lock Cylinder, With Key, LH or RH | 11813.03 |
| 1995 Grand Cherokee, Door Lock Cylinder, With Key, LH or RH | 11813.04 |
| 1996-1998 Grand Cherokee, Door Lock Cylinder, With Key, LH or RH | 11813.05 |
| 1999-2004 Grand Cherokee, Door Lock Cylinder, With Key, LH or RH | 11813.06 |
| 1993-1998 Grand Cherokee, Power Window Motor, Front, Left NEW | 11821.51 |
| 1993-1998 Grand Cherokee, Power Window Motor, Front, Right NEW | 11821.50 |
| 1993-1998 Grand Cherokee, Window Regulator, Manual, Front, Left | 11821.01 |
| 1993-1998 Grand Cherokee, Window Regulator, Manual, Front, Right | 11821.02 |
| 1993-1998 Grand Cherokee, Window Regulator, Power, Front, Left | 11821.03 |
| 1993-1998 Grand Cherokee, Window Regulator, Power, Front, Right | 11821.04 |
| 1999-2000 Grand Cherokee, Window Regulator, Power, Front, Left | 11821.05 |
| 1999-2000 Grand Cherokee, Window Regulator, Power, Front, Right | 11821.06 |
| 2001-2004 Grand Cherokee, Window Regulator, Power, Front, Left | 11821.08 |
| 2001-2004 Grand Cherokee, Window Regulator, Power, Front, Right | 11821.07 |
| 1993-1996 Grand Cherokee, Mirror, Black, Folding, Power Remote, Left | 12037.17 |
| 1993-1996 Grand Cherokee, Mirror, Black, Folding, Power Remote, Right | 12037.16 |
| 1993-1995 Grand Cherokee, Mirror, Black, Folding, Power Remote, Heated, Left | 12037.19 |
| 1993-1995 Grand Cherokee, Mirror, Black, Folding, Power Remote, Heated, Right | 12037.18 |
| 1996-1998 Grand Cherokee, Mirror, Black, Folding, Power Remote, Heated, Left | 12037.21 |
| 1996-1998 Grand Cherokee, Mirror, Black, Folding, Power Remote, Heated, Right | 12037.20 |
| 1999-2004 Grand Cherokee, Mirror, Black, Folding, Power Remote, Left | 12039.07 |
| 1999-2004 Grand Cherokee, Mirror, Black, Folding, Power Remote, Right | 12039.06 |
| 1999-2004 Grand Cherokee, Mirror, Black, Folding, Power Remote, Heated, Left | 12039.09 |
| 1999-2004 Grand Cherokee, Mirror, Black, Folding, Power Remote, Heated, Right | 12039.08 |
| 2005-2010 Grand Cherokee, Mirror, Black, Folding, Power Remote, Left NEW | 12039.11 |
| 2005-2010 Grand Cherokee, Mirror, Black, Folding, Power Remote, Right NEW | 12039.10 |
| 2005-2010 Grand Cherokee, Mirror, Black, Folding, Power Remote, Heated, Left NEW | 12039.13 |
| 2005-2010 Grand Cherokee, Mirror, Black, Folding, Power Remote, Heated, Right NEW | 12039.12 |
| 1993-1998 Grand Cherokee, Liftgate Support Strut (Shock), Left | 12012.07 |
| 1993-1998 Grand Cherokee, Liftgate Support Strut (Shock), Right | 12012.06 |
| 1996-1998 Grand Cherokee, Liftgate Glass Support Strut (Shock), LH or RH | 12012.09 |
| 1999-2004 Grand Cherokee, Liftgate Support Strut (Shock), LH or RH | 12012.08 |
| 1999-2004 Grand Cherokee, Liftgate Glass Support Strut (Shock), LH or RH | 12012.10 |
| 2005-2010 Grand Cherokee, Liftgate Support Strut (Shock) LH or RH NEW | 12012.18 |
| 2005-2007 Grand Cherokee, Liftgate Glass Support Strut (Shock) LH or RH | 12012.16 |
| 2008-2010 Grand Cherokee, Liftgate Glass Support Strut (Shock) LH or RH | 12012.18 |

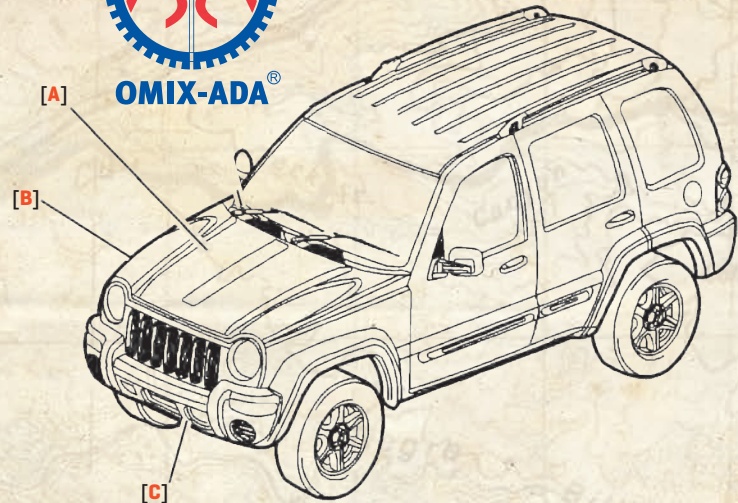

[A] 12042.01



| A. Hoods | Part# |
|--|----------|
| 2002-2004 Liberty, Hood | 12042.01 |
| 2002-2007 Liberty, Hood Support Strut (Shock) LH or RH | 12012.13 |

| B. Fenders | Part# |
|----------------------------------|----------|
| 2002-2004 Liberty, Fender, Left | 12042.03 |
| 2002-2004 Liberty, Fender, Right | 12042.02 |

| C. Bumpers & Components | Part# |
|--|----------|
| 2002-2004 Liberty Base, Limited, Sport, Front Bumper Cover, Primed for Paint | 12042.05 |
| 2002-2004 Liberty Base, Limited, Sport, Front Bumper Cover, Gray | 12042.06 |
| 2002-2004 Liberty Renegade, Front Bumper Cover | 12042.07 |

| D. Grilles | Part# |
|---------------------------------|----------|
| 2002-2004 Liberty, Header Panel | 12042.04 |



| E. Body Accessories | Part# |
|--|----------|
| 2002-2007 Liberty, Mirror, Black Textured, Folding, Non-power, Left | 12042.11 |
| 2002-2007 Liberty, Mirror, Black Textured, Folding, Non-power, Right | 12042.10 |
| 2002-2007 Liberty, Mirror, Black Textured, Folding, Power, Left | 12042.13 |
| 2002-2007 Liberty, Mirror, Black Textured, Folding, Power, Right | 12042.12 |
| 2002-2007 Liberty, Mirror, Black Textured, Folding, Power, Without Lock Hole, Front, Right | 12042.15 |
| 2002-2007 Liberty, Mirror, Black Textured, Folding, Power, Without Lock Hole, Front, Right | 12042.14 |
| 2002-2007 Liberty, Exterior Door Handle, Black Textured, Front, Left | 12042.31 |
| 2002-2007 Liberty, Exterior Door Handle, Black Textured, With Lock Hole, Front, Right | 12042.32 |
| 2002-2007 Liberty, Exterior Door Handle, Black Textured, Without Lock Hole, Front, Right | 12042.34 |
| 2002-2007 Liberty, Exterior Door Handle, Black Textured, Rear, Left | 12042.35 |
| 2002-2007 Liberty, Exterior Door Handle, Black Textured, Rear, Right | 12042.36 |
| 2004 Liberty, Door Lock Cylinder With Key, LH or RH | 11813.06 |
| 2002-2003 Liberty, 2005-2007 Liberty, Door Lock Cylinder With Key, LH or RH | 11813.07 |
| 2002-2007 Liberty, Liftgate Support Strut (Shock) LH or RH | 12012.15 |

All images are subject to be representative. More detailed information is available online.

Dana 25 - 1941-1945 MB, 1941-1945 Ford GPW, 1945-1949 CJ2A, 1946-1964 Truck, 1946-1964 Station Wagon, 1949-1953 CJ3A, 1952-1971 M38A1, 1953-1967 CJ3B, 1950-1952 M38, 1955-1971 CJ5, 1955-1971 CJ6

Dana 27 - 1966-1975 CJ5, 1966-1975 CJ6

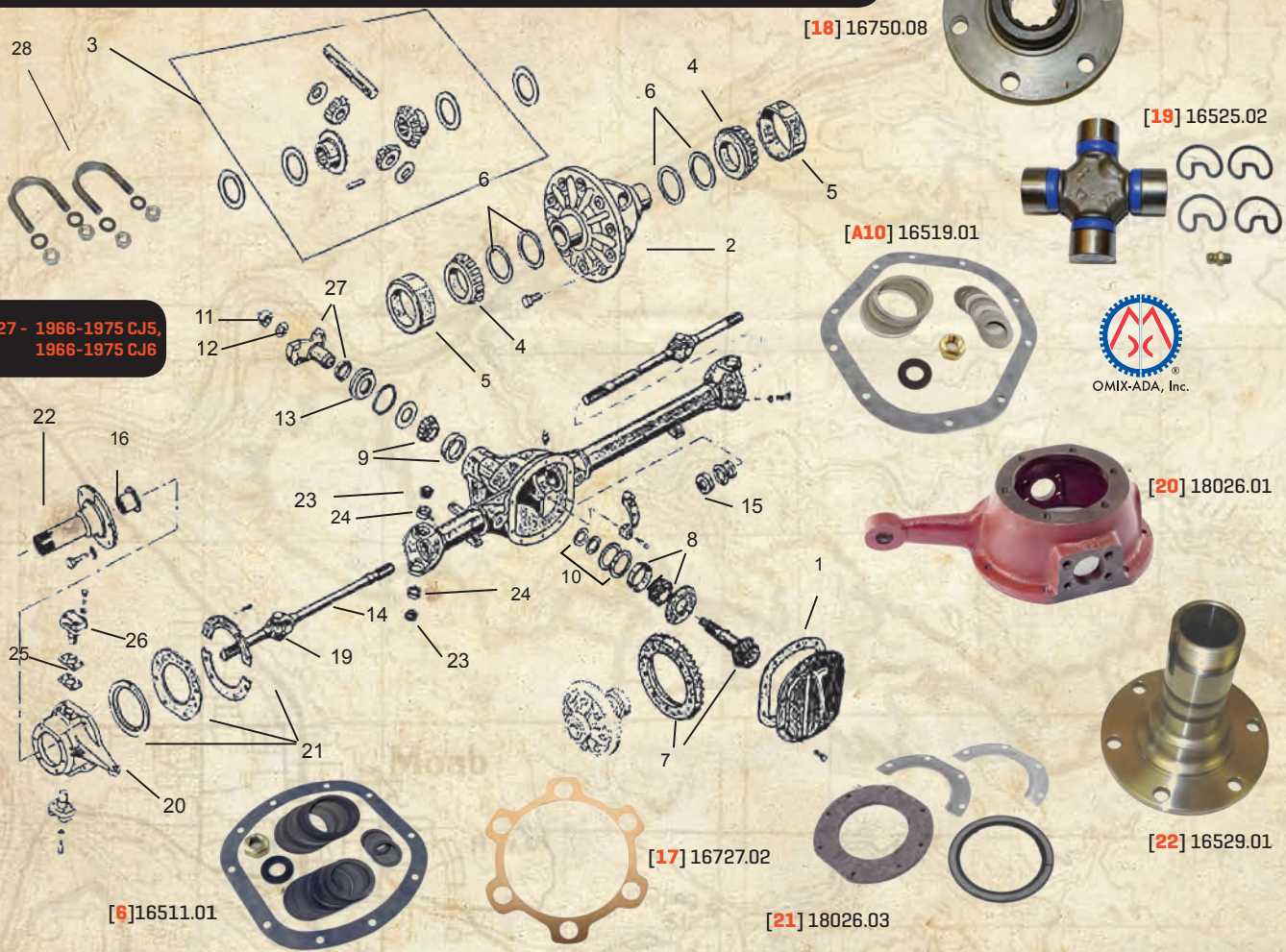

OMIX-ADA, Inc.

A. Dana 25 (Front) & Dana 27 (Front & Rear)

Part#

| | | |
|----|---|----------|
| 1 | 1941-1971 Models, Different Cover Gasket [Dana 25 & Dana 27] | 16502.01 |
| 2 | 1946-1971 Models, Standard Differential Case 3.31-3.73 Ratio [Dana 25 & Dana 27] | 16503.02 |
| 3 | 1941-71 Models, Spider Gear Kit for Standard Differential [Dana 27] | 16507.01 |
| 4 | 1941-71 Models, Differential Side Bearing [Dana 25 & Dana 27 Rear] [2 Required] | 16509.01 |
| 4 | 1941-71 Models, Differential Side Bearing [Dana 27 Front] [2 Required] | 16706.02 |
| 5 | 1941-71 Models, Differential Side Bearing Cup [Dana 25 & Dana 27 Rear] [2 Required] | 16509.03 |
| 5 | 1941-71 Models, Differential Side Bearing Cup [Dana 27 Front] [2 Required] | 16509.04 |
| 6 | 1941-71 Models, Differential Side Bearing Shim Kit [Dana 25 & Dana 27] | 16511.01 |
| 7 | 1941-1971 CJ, Ring & Pinion, 4.88 Ratio [Dana 25 & Dana 27 Rear], 39 x 8 Teeth | 16513.02 |
| 8 | 1941-71 Models, Inner Pinion Bearing [Dana 25 & Dana 27 Rear] | 16515.01 |
| 8 | 1941-71 Models, Inner Pinion Bearing [Dana 27 Front] | 16515.02 |
| 9 | 1941-71 Models, Outer Pinion Bearing [Dana 25 & Dana 27] | 16517.01 |
| 10 | 1941-71 Models, Pinion Bearing Shim Kit [Dana 25 & Dana 27] | 16519.01 |
| 11 | 1941-71 Models, Pinion Nut [Dana 25 & Dana 27] | 16584.01 |
| 12 | 1941-71 Models, Pinion Washer [Dana 25 & Dana 27] | 16584.02 |
| 13 | 1941-71 Models, Pinion Oil Seal [Dana 25 & Dana 27] | 16521.01 |
| 13 | 1941-71 Models, Pinion Oil Seal [Dana 25 & Dana 27], National Brand | 16521.02 |
| 14 | 1941-71 Models, Axle Shaft Assembly [Dana 25 & Dana 27 Front], Right | 16523.02 |
| 14 | 1941-71 Models, Axle Shaft Assembly [Dana 25 & Dana 27 Front], Left | 16523.01 |
| 15 | 1941-1945 MB, 1941-1945 Ford GPW, Inner Axle Oil Seal [Dana 27 Rear] | 16526.01 |
| 16 | 1941-71 Models, Spindle Bushing [Dana 25 & Dana 27 Front] | 16529.02 |
| 17 | 1941-71 Models, Drive Flange Gasket [Dana 25 & Dana 27 Front] | 16727.02 |

A. Dana 25 (Front) & Dana 27 (Front & Rear)

Part#

| | | |
|----|---|----------|
| 18 | 1941-71 Models, Drive Flange [Dana 25 & Dana 27 Front], LH or RH | 16750.08 |
| 19 | 1941-71 Models, U-Joint [Dana 25 & Dana 27 Front], LH or RH, Greasable UPGRADE | 16525.01 |
| 19 | 1941-71 Models, U-Joint [Dana 25 & Dana 27 Front], LH or RH, Greasable, Spicer Brand UPGRADE | 16525.02 |
| 19 | 1941-71 Models, U-Joint [Dana 25 & Dana 27 Front], LH or RH, Non-Greasable | 16525.03 |
| 20 | 1941-1945 MB, 1941-1945 Ford GPW, 1945-1949 CJ2A, 1948-1953 CJ3A, 1950-1952 M38, 1953-1967 CJ3B, 1953-1971 M38A1, 1955-1971 CJ5, 1955-1971, Steering Knuckle, Left | 18026.01 |
| 20 | 1941-1945 MB, 1941-1945 Ford GPW, 1945-1949 CJ2A, 1948-1953 CJ3A, 1950-1952 M38, 1953-1967 CJ3B, 1953-1971 M38A1, 1955-1971 CJ5, 1955-1971, Steering Knuckle, Right | 18026.02 |
| 21 | 1941-1945 MB, 1941-1945 Ford GPW, 1945-1949 CJ2A, 1948-1953 CJ3A, 1950-1952 M38, 1953-1967 CJ3B, 1953-1971 M38A1, 1955-1971 CJ5, 1955-1971, Steering Seal Kit, LH or RH | 18026.03 |
| 22 | 1941-71 Models, Spindle [Dana 25 & Dana 27 Front] | 16529.01 |
| 23 | 1941-71 Models, King Pin Bearing [Dana 25 & Dana 27 Front] | 18026.05 |
| 24 | 1941-71 Models, King Pin Bearing Cup [Dana 25 & Dana 27 Front] | 18026.06 |
| 25 | 1941-71 Models, King Pin Bearing Shim Kit [Dana 25 & Dana 27 Front] | 18026.07 |
| 26 | 1941-71 Models, King Pin Cap [Dana 25 & Dana 27 Front] | 18026.04 |
| 27 | 1941-71 Models, Pinion Shaft Yoke [Dana 25 & Dana 27 Front], 10 Spline | 16580.04 |
| 27 | 1941-71 Models, Transfer Case Output Yoke [Dana 25 & Dana 27 Rear], 10 Spline | 16580.01 |
| 28 | 1941-71 Models, Yoke [Dana 25 & Dana 27], 10 Spline | 16582.01 |
| 28 | 1941-71 Models, Yoke U-Bolts [Dana 25 & Dana 27], Pair | 16582.02 |

Axle - Front Dana Model 30

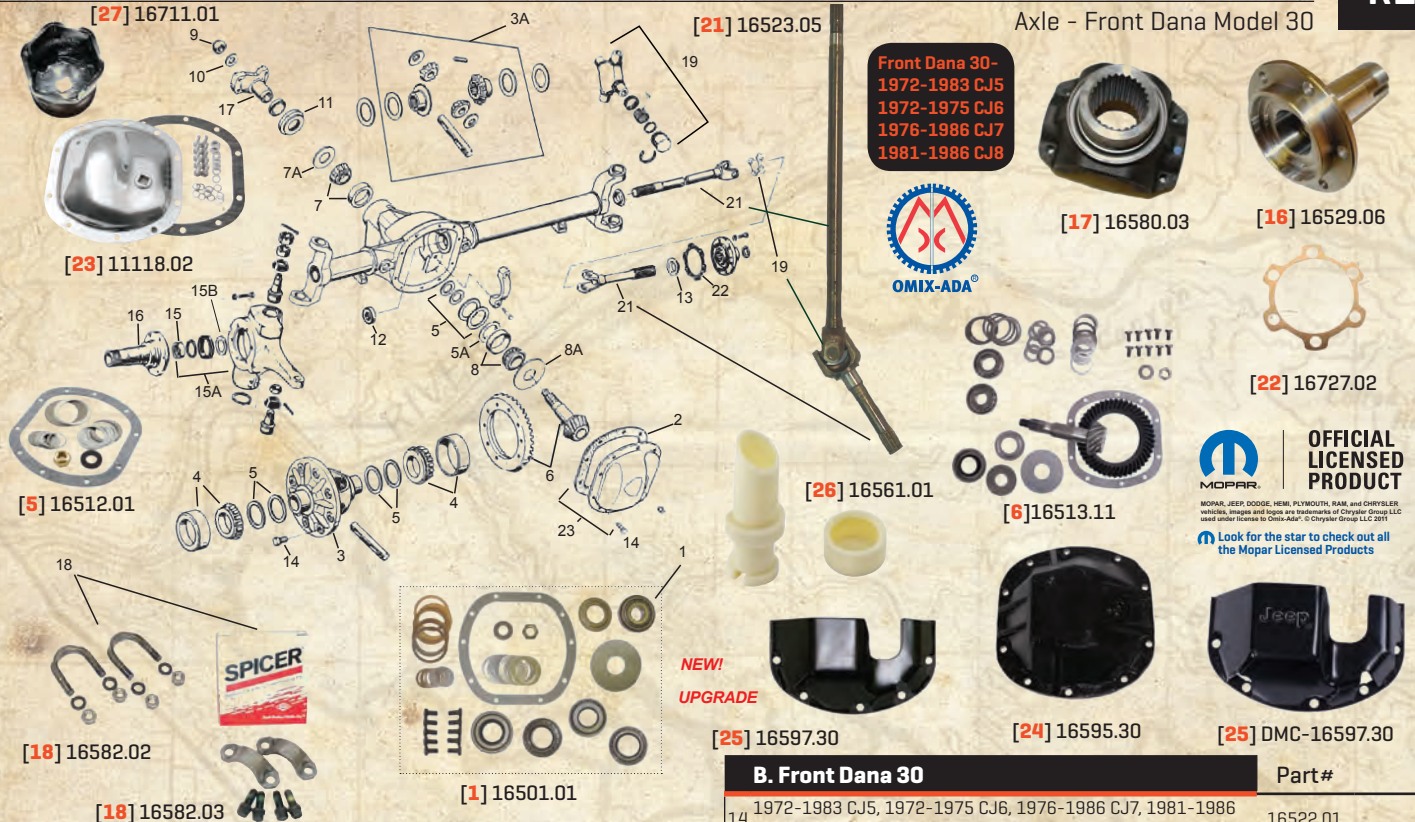

Front Dana 30-
1972-1983 CJ5
1972-1975 CJ6
1976-1986 CJ7
1981-1986 CJ8



MOPAR
OFFICIAL LICENSED PRODUCT
MOPAR, JEEP, DODGE, RAM, PLYMOUTH, RAM, and CHRYSLER vehicles, images and logos are trademarks of Chrysler Group LLC used under license by Omix-Ada. © Chrysler Group LLC 2015
Look for the star to check out all the Mopar Licensed Products

| B. Front Dana 30 | | Part# |
|------------------|---|----------|
| 1 | 1972-1983 CJ5, 1972-1975 CJ6, 1976-1986 CJ7, 1981-1986 CJ8, Master Rebuild Kit [Dana 30] | 16501.01 |
| 2 | 1972-1983 CJ5, 1972-1975 CJ6, 1976-1986 CJ7, 1981-1986 CJ8, Differential Cover Gasket [Dana 30] | 16502.01 |
| 3 | 1972-1983 CJ5, 1972-1975 CJ6, 1976-1986 CJ7, 1981-1986 CJ8, Standard Differential Case [Dana 30], 2.75-3.54 Ratio | 16503.04 |
| 3 | 1976-1983 CJ5, 1976-1986 CJ7, 1981-1986 CJ8, Standard Differential Case [Dana 30], 3.73 [1981], 4.09 to 4.10 [1976-1986] Ratio | 16503.49 |
| 3 | 1976-1983 CJ5, 1976-1986 CJ7, 1981-1986 CJ8, Standard Differential Case [Dana 30], 3.73 to 5.38 Ratio | 16503.05 |
| 3A | 1972-1983 CJ5, 1972-1975 CJ6, 1976-1986 CJ7, 1981-1986 CJ8, Spider Gear Kit [Dana 30] | 16507.02 |
| 4 | 1986 CJ8, Differential Side Bearing Kit [Dana 30], Includes: 2 Bearings & 2 Cups | 16509.05 |
| 5 | 1972-1983 CJ5, 1972-1975 CJ6, 1976-1986 CJ7, 1981-1986 CJ8, Carrier Shim Kit [Dana 30] | 16512.01 |
| 5A | 1972-1983 CJ5, 1972-1975 CJ6, 1976-1986 CJ7, 1981-1986 CJ8, Inner Pinion Bearing Baffle [Dana 30] | 16512.53 |
| 6 | 1972-1983 CJ5, 1972-1975 CJ6, 1976-1986 CJ7, 1981-1986 CJ8, Ring & Pinion Kit [Dana 30], 3.54 Ratio [46x13 Teeth] | 16513.11 |
| 6 | 1972-1983 CJ5, 1972-1975 CJ6, 1976-1986 CJ7, 1981-1986 CJ8, Ring & Pinion [Dana 30], 3.73 Ratio [41 x 11 Teeth] | 16513.12 |
| 6 | 1972-1983 CJ5, 1972-1975 CJ6, 1976-1986 CJ7, 1981-1986 CJ8, Ring & Pinion Kit [Dana 30], 4.10 Ratio [41 x 10 Teeth] | 16513.13 |
| 6 | 1972-1983 CJ5, 1972-1975 CJ6, 1976-1986 CJ7, 1981-1986 CJ8, Ring & Pinion Kit [Dana 30], 4.27 Ratio [47 x 11 Teeth] | 16513.14 |
| 6 | 1972-1983 CJ5, 1972-1975 CJ6, 1976-1986 CJ7, 1981-1986 CJ8, Ring & Pinion Kit [Dana 30], 4.56 Ratio [41 x 9 Teeth] | 16513.15 |
| 7 | 1972-1983 CJ5, 1972-1975 CJ6, 1976-1986 CJ7, 1981-1986 CJ8, Outer Pinion Bearing Kit [Dana 30], Includes: 1 Bearing Race & 1 Bearing Cup | 16517.01 |
| 7A | 1972-1983 CJ5, 1972-1975 CJ6, 1976-1986 CJ7, 1981-1986 CJ8, Outer Pinion Oil Slinger [Dana 30] | 16512.52 |
| 8 | 1972-1983 CJ5, 1972-1975 CJ6, 1976-1986 CJ7, 1981-1986 CJ8, Inner Pinion Bearing Kit [Dana 30], Includes: 1 Bearing Race & 1 Bearing Cup | 16515.02 |
| 8A | 1972-1983 CJ5, 1972-1975 CJ6, 1976-1986 CJ7, 1981-1986 CJ8, Inner Pinion Oil Slinger [Dana 30] | 16512.51 |
| 9 | 1972-1983 CJ5, 1972-1975 CJ6, 1976-1986 CJ7, 1981-1986 CJ8, Pinion Nut [Dana 30] | 16584.01 |
| 10 | 1972-1983 CJ5, 1972-1975 CJ6, 1976-1986 CJ7, 1981-1986 CJ8, Pinion Washer [Dana 30] | 16584.02 |
| 11 | 1972-1983 CJ5, 1972-1975 CJ6, 1976-1986 CJ7, 1981-1986 CJ8, Pinion Oil Seal [Dana 30] | 16521.01 |
| 11 | 1972-1983 CJ5, 1972-1975 CJ6, 1976-1986 CJ7, 1981-1986 CJ8, Pinion Oil Seal [Dana 30], National Brand | 16521.02 |
| 12 | 1972-1983 CJ5, 1972-1975 CJ6, 1976-1986 CJ7, 1981-1986 CJ8, Inner Axle Oil Seal [Dana 30], LH or RH | 16526.02 |
| 13 | 1972-1983 CJ5, 1972-1975 CJ6, 1976-1986 CJ7, 1981-1986 CJ8, Inner Axle Dust Shield [Dana 30] | 16527.04 |

| B. Front Dana 30 | | Part# |
|------------------|--|--------------|
| 14 | 1972-1983 CJ5, 1972-1975 CJ6, 1976-1986 CJ7, 1981-1986 CJ8, Ring Gear Bolt [Dana 30], [10 Required] | 16522.01 |
| 14 | 1972-1983 CJ5, 1972-1975 CJ6, 1976-1986 CJ7, 1981-1986 CJ8, Differential Cover Bolt [Dana 30] | 16522.02 |
| 15 | 1972-1983 CJ5, 1972-1975 CJ6, 1976-1986 CJ7, 1981-1986 CJ8, Spindle Bearing [Dana 30] | 16529.03 |
| 15A | 1972-1983 CJ5, 1972-1975 CJ6, 1976-1986 CJ7, 1981-1986 CJ8, Spindle Bearing Kit [Dana 30], With Seal & Washer | 16529.04 |
| 15B | 1972-1977 CJ5, 1972-1975 CJ6, 1976-1977 CJ7, Spindle Thrust Washer [Dana 30], With Drum Brakes | 16529.05 |
| 16 | 1972-1977 CJ5, 1972-1975 CJ6, 1976-1977 CJ7, Spindle [Dana 30], With Drum Brakes | 16529.06 |
| 16 | 1977-1986 CJ5, 1977-1986 CJ7, 1981-1986 CJ8, Spindle [Dana 30], With Disc Brakes | 16529.07 |
| 16 | 1972-1983 CJ5, 1972-1975 CJ6, 1976-1986 CJ7, 1981-1986 CJ8, Yoke [Dana 30], [U-Bolt Style] | 16580.02 |
| 17 | 1981-1983 CJ, 1981-1986 CJ7, 1981-1986 CJ8, Yoke [Strap & Bolt Style [Dana 30], With Dana 300 Transfer Case | 16580.03 |
| 17 | 1972-1983 CJ5, 1972-1975 CJ6, 1976-1986 CJ7, 1981-1986 CJ8, Yoke Kit , [U-Bolt Style [Dana 30]], Includes: Yoke, Pinion Spacer, Pinion Seals, U-Joints & Pinion Nut | 16580.27 |
| 18 | 1972-1983 CJ5, 1972-1975 CJ6, 1976-1986 CJ7, 1981-1986 CJ8, Yoke U-Bolts [Dana 30], Pair | 16582.01 |
| 18 | 1972-1983 CJ5, 1972-1975 CJ6, 1976-1986 CJ7, 1981-1986 CJ8, Yoke U-Bolts [Dana 30], Pair, Dana Spicer Brand | 16582.02 |
| 18 | 1981-1983 CJ, 1981-1986 CJ7, 1981-1986 CJ8, Yoke Strap & Bolt Kit [Dana 30], With Dana 300 Transfer Case | 16582.03 |
| 19 | 1972-1983 CJ5, 1972-1975 CJ6, 1976-1986 CJ7, 1981-1986 CJ8, U-Joint [Dana 30], LH or RH, Greasable UPGRADE | 16525.01 |
| 19 | 1972-1983 CJ5, 1972-1975 CJ6, 1976-1986 CJ7, 1981-1986 CJ8, U-Joint [Dana 30], LH or RH, Greasable UPGRADE | 16525.02 |
| 19 | 1972-1983 CJ5, 1972-1975 CJ6, 1976-1986 CJ7, 1981-1986 CJ8, U-Joint [Dana 30], LH or RH, Non-Greasable | 16525.03 |
| 19 | Axle Shaft Outer D30 72-86 NEW | 16523.03 |
| 21 | 1977-1981 CJ5, 1977-1981 CJ7, 1981 CJ8, Axle Shaft Assembly [Dana 30], LH With Disc Brakes [35-3/4"] | 16523.05 |
| 21 | 1977-1981 CJ5, 1977-1981 CJ7, 1981 CJ8, Axle Shaft Assembly [Dana 30], RH With Disc Brakes [22-7/8"] | 16523.04 |
| 21 | 1982-1986 CJ7, 1982-1986 CJ8, Axle Shaft Assembly [Dana 30], LH [37-11/32"] | 16523.06 |
| 21 | 1982-1986 CJ7, 1982-1986 CJ8, Axle Shaft Assembly [Dana 30], RH [24-9/16"] | 16523.06 |
| 22 | 1972-1983 CJ5, 1972-1975 CJ6, 1976-1986 CJ7, 1981-1986 CJ8, Drive Flange Gasket [Dana 30] | 16727.02 |
| 23 | 1972-1983 CJ5, 1972-1975 CJ6, 1976-1986 CJ7, 1981-1986 CJ8, Differential Cover Kit [Dana 30], Stainless Steel UPGRADE | 11118.02 |
| 24 | 1972-1983 CJ5, 1972-1975 CJ6, 1976-1986 CJ7, 1981-1986 CJ8, Differential Cover Kit [Dana 30], Heavy Duty, Cast Steel UPGRADE | 16595.30 |
| 25 | 1972-1983 CJ5, 1972-1975 CJ6, 1976-1986 CJ7, 1981-1986 CJ8, Differential Skid Plate [Dana 30], Heavy Duty, Cast Steel UPGRADE | 16597.30 |
| 25 | 1972-1983 CJ5, 1972-1975 CJ6, 1976-1986 CJ7, 1981-1986 CJ8, Differential Skid Plate [Dana 30] Heavy Duty, Cast Steel | DMC-16597.30 |
| 26 | 1972-1983 CJ5, 1972-1975 CJ6, 1976-1986 CJ7, 1981-1986 CJ8, Axle Breather [Dana 30] | 16561.01 |
| 27 | 1972-1983 CJ5, 1972-1975 CJ6, 1976-1986 CJ7, 1981-1986 CJ8, Spindle Nut Socket [Dana 30] | 16711.01 |

All images are subject to be representative. More detailed information is available online.

Axle

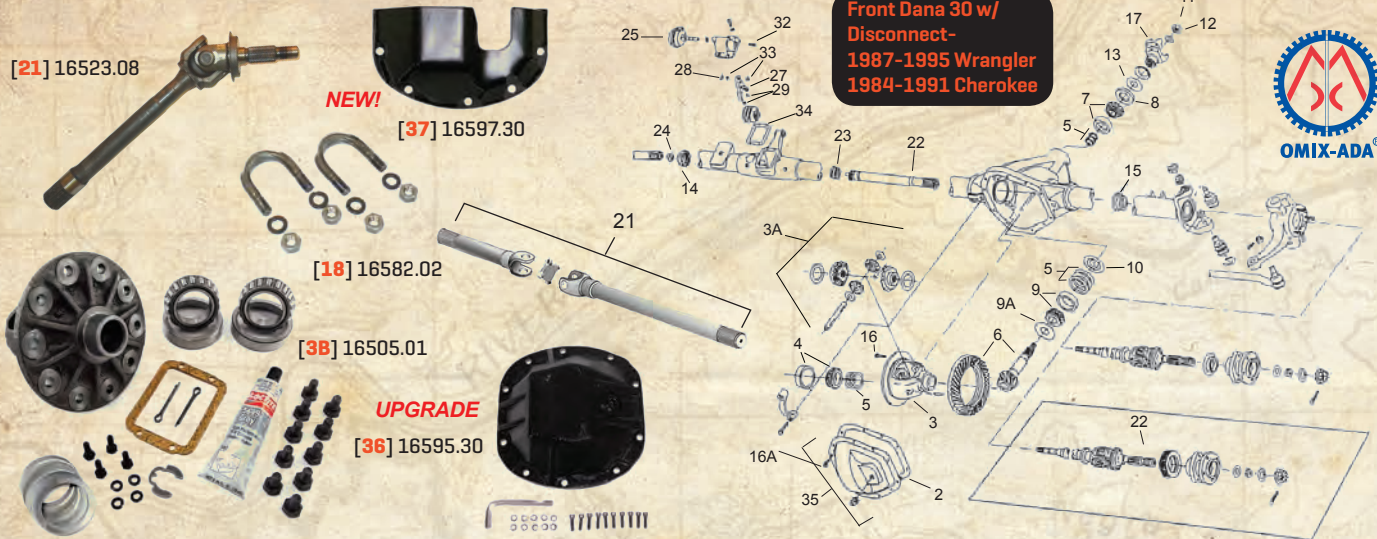

| C. Front Dana 30 With Disconnect | Part# |
|--|----------|
| 1 1984-1991 Cherokee, 1987-1995 Wrangler, <i>Differential Rebuild Kit</i> (Dana 30 w/ Disconnect) | 16501.02 |
| 2 1984-1991 Cherokee, 1987-1995 Wrangler, <i>Differential Cover Gasket</i> (Dana 30 w/ Disconnect) | 16502.01 |
| 3 1984-1991 Cherokee, 1987-1995 Wrangler, <i>Standard Differential Case</i> (Dana 30 w/ Disconnect), 2.75 to 3.54 Ratio | 16503.04 |
| 3 1984-1991 Cherokee, 1987-1995 Wrangler, <i>Standard Differential Case</i> (Dana 30 w/ Disconnect), 3.73 to 5.38 Ratio | 16503.05 |
| 3A 1984-1991 Cherokee, 1987-1995 Wrangler, <i>Spider Gear Kit, With Standard Differential</i> (Dana 30 w/ Disconnect) | 16507.03 |
| 3B 1990-1995 Wrangler, 1990-1991 Cherokee, <i>Standard Differential Case Assembly Kit</i> (Dana 30 w/ Disconnect), 3.07 to 3.55 Ratio, Includes: Case, Spider Gears, Shims, Ring Gear Bolts & Gasket | 16505.01 |
| 3B 1984-1989 Cherokee, 1987-1989 Wrangler, <i>Standard Differential Case Assembly Kit</i> (Dana 30 w/ Disconnect), 3.73 to 4.10 Ratio, Includes: Case, Spider Gears, Shims, Ring Gear Bolts & Gasket | 16505.02 |
| 3B 1984-1989 Cherokee, 1987-1989 Wrangler, <i>Standard Differential Case Assembly Kit</i> (Dana 30 w/ Disconnect), 3.07 to 3.55 Ratio, Includes: Case, Spider Gears, Shims, Ring Gear Bolts & Gasket | 16505.03 |
| 3B 1984-1989 Cherokee, 1987-1989 Wrangler, <i>Standard Differential Case Assembly Kit</i> (Dana 30 w/ Disconnect), 3.73 to 4.10 Ratio, Includes: Case, Spider Gears, Shims, Ring Gear Bolts & Gasket | 16505.04 |
| 4 1984-1991 XJ Cherokee, 1987-1995 Wrangler, <i>Differential Side Bearing Kit</i> (Dana 30 w/ Disconnect), Includes 2 Bearings & 2 Cups | 16509.05 |
| 5 1984-1991 Cherokee, 1987-1995 Wrangler, <i>Differential Side Bearing Shim Kit</i> (Dana 30 w/ Disconnect) | 16512.02 |
| 6 1984-1991 Cherokee, 1987-1995 Wrangler, <i>Ring & Pinion Kit</i> (Dana 30 w/ Disconnect), 3.07 Ratio (43 x 14 Teeth) | 16513.20 |
| 6 1984-1991 Cherokee, 1987-1995 Wrangler, <i>Ring & Pinion Kit</i> (Dana 30 w/ Disconnect), 3.54 Ratio (39 x 11 Teeth) | 16513.21 |
| 6 1984-1991 Cherokee, 1987-1995 Wrangler, <i>Ring & Pinion Kit</i> (Dana 30 w/ Disconnect), 3.73 Ratio (41 x 11 Teeth) | 16513.22 |
| 6 1984-1991 Cherokee, 1987-1995 Wrangler, <i>Ring & Pinion Kit</i> (Dana 30 w/ Disconnect), 4.10 Ratio (41 x 10 Teeth) | 16513.23 |
| 6 1984-1991 Cherokee, 1987-1995 Wrangler, <i>Ring & Pinion Kit</i> (Dana 30 w/ Disconnect), 4.56 Ratio (41 x 9 Teeth) | 16513.24 |
| 6 1984-1991 Cherokee, 1987-1995 Wrangler, <i>Ring & Pinion Kit</i> (Dana 30 w/ Disconnect), 4.88 Ratio (43 x 9 Teeth) | 16513.25 |
| 7 1984-1991 Cherokee, 1987-1995 Wrangler, <i>Outer Pinion Bearing Kit</i> (Dana 30 w/ Disconnect), Includes: 1 Bearing Race & 1 Bearing Cup | 16517.01 |
| 8 1984-1991 Cherokee, 1987-1995 Wrangler, <i>Outer Pinion Oil Slinger</i> (Dana 30 w/ Disconnect) | 16512.52 |
| 9 1984-1991 Cherokee, 1987-1995 Wrangler, <i>Inner Pinion Bearing Kit</i> (Dana 30 w/ Disconnect), Includes: 1 Bearing Race & 1 Bearing Cup | 16515.02 |
| 9A 1984-1991 Cherokee, 1987-1995 Wrangler, <i>Inner Pinion Oil Slinger</i> (Dana 30 w/ Disconnect) | 16512.51 |
| 10 1984-1991 Cherokee, 1987-1995 Wrangler, <i>Inner Pinion Bearing Baffle</i> (Dana 30 w/ Disconnect) | 16512.53 |
| 11 1984-1991 Cherokee, 1987-1995 Wrangler, <i>Pinion Nut</i> (Dana 30 w/ Disconnect) | 16584.01 |
| 12 1984-1991 Cherokee, 1987-1995 Wrangler, <i>Pinion Washer</i> (Dana 30 w/ Disconnect) | 16584.02 |
| 13 1984-1991 Cherokee, 1987-1995 Wrangler, <i>Pinion Oil Seal</i> (Dana 30 w/ Disconnect) | 16521.01 |
| 13 1984-1991 Cherokee, 1987-1995 Wrangler, <i>Pinion Oil Seal</i> (Dana 30 w/ Disconnect), National Brand | 16521.02 |
| 14 1984-1991 Cherokee, 1987-1995 Wrangler, <i>Inner Axle Oil Seal</i> (Dana 30 w/ Disconnect), RH (2.12" O.D.) | 16526.03 |
| 14 1984-1991 Cherokee, 1987-1995 Wrangler, <i>Inner Axle Oil Seal</i> (Dana 30 w/ Disconnect), RH (2.29" O.D.) | 16526.06 |
| 15 1984-1991 Cherokee, 1987-1995 Wrangler, <i>Inner Axle Oil Seal</i> (Dana 30 w/ Disconnect), LH | 16526.02 |

| C. Front Dana 30 With Disconnect | Part# |
|---|--------------|
| 16 1984-1991 Cherokee, 1987-1995 Wrangler, <i>Ring Gear Bolt</i> (Dana 30 w/ Disconnect), [10 Required] | 16522.01 |
| 16A 1984-1991 Cherokee, 1987-1995 Wrangler, <i>Differential Cover Bolt</i> (Dana 30 w/ Disconnect) | 16522.02 |
| 17 1984-1991 Cherokee, 1987-1995 Wrangler, <i>Yoke U-Bolt Style</i> (Dana 30 w/ Disconnect) | 16580.02 |
| 17 1984-1991 Cherokee, 1987-1995 Wrangler, <i>Yoke Strap & Bolt Style</i> (Dana 30 w/ Disconnect) | 16580.07 |
| 18 1984-1991 Cherokee, 1987-1995 Wrangler, <i>Yoke U-Bolts</i> (Dana 30 w/ Disconnect), Pair | 16582.01 |
| 18 1984-1991 Cherokee, 1987-1995 Wrangler, <i>Yoke U-Bolts</i> (Dana 30 w/ Disconnect), Pair, Dana Spicer Brand | 16582.02 |
| 19 1984-1991 Cherokee, 1987-1995 Wrangler, <i>Yoke Strap & Bolt Kit</i> (Dana 30 w/ Disconnect) | 16582.03 |
| 20 1984-1991 Cherokee, 1987-1994 Wrangler, <i>U-Joint</i> (Dana 30 w/ Disconnect), LH or RH, Greasable | 16525.01 |
| 20 1984-1991 Cherokee, 1987-1994 Wrangler, <i>U-Joint</i> (Dana 30 w/ Disconnect), LH or RH, Greasable, Spicer Brand | 16525.02 |
| 20 1984-1991 Cherokee, 1987-1994 Wrangler, <i>U-Joint</i> (Dana 30 w/ Disconnect), LH or RH, Non-Greasable | 16525.03 |
| 20 1995 Wrangler, <i>U-Joint</i> (Dana 30 w/ Disconnect), LH or RH, Greasable | 16525.04 |
| 20 1995 Wrangler, <i>U-Joint</i> (Dana 30 w/ Disconnect), LH or RH, Non-Greasable | 16525.05 |
| 20 1995 Wrangler, <i>U-Joint</i> (Dana 30 w/ Disconnect), LH or RH, Greasable, Spicer Brand | 16525.06 |
| 21 1987-1995 Wrangler, <i>Axle Shaft Assembly</i> (Dana 30 w/ Disconnect), RH Without ABS | 16523.08 |
| 21 1987-1995 Wrangler, <i>Axle Shaft Assembly</i> (Dana 30 w/ Disconnect), RH Without ABS | 16523.10 |
| 21 1987-1995 Wrangler, <i>Axle Shaft Assembly</i> (Dana 30 w/ Disconnect), LH Without ABS | 16523.09 |
| 21 1987-1995 Wrangler, <i>Axle Shaft Assembly</i> (Dana 30 w/ Disconnect), LH Without ABS | 16523.11 |
| 22 1987-1994 Wrangler, <i>Outer Axle (Stub) Shaft</i> (Dana 30 w/ Disconnect), LH or RH Without ABS | 16523.13 |
| 23 1987-1989 Wrangler, <i>Inner Bushing Bearing</i> (Dana 30 w/ Disconnect) | 16527.20 |
| 23 1990-1995 Wrangler, <i>Inner Bushing Bearing</i> (Dana 30 w/ Disconnect), Without ABS | 16527.06 |
| 24 1984-1989 Cherokee, 1987-1989 Wrangler, <i>Outer Axle Shaft Bearing</i> (Dana 30 w/ Disconnect) | 16527.07 |
| 24 1990-1995 Wrangler, 1990-1991 Cherokee, <i>Outer Axle Shaft Bearing</i> (Dana 30 w/ Disconnect) | 16527.08 |
| 25 1991-1995 Wrangler, <i>Axle Disconnect Motor Assembly</i> (Dana 30 w/ Disconnect) | 16527.10 |
| 27 1987-1995 Wrangler, <i>Axle Disconnect Shift Fork</i> (Dana 30 w/ Disconnect) | 16527.12 |
| 28 1987-1995 Wrangler, <i>Axle Disconnect Motor Retaining Clip</i> (Dana 30 w/ Disconnect) | 16527.13 |
| 29 1987-1995 Wrangler, <i>Axle Disconnect Shift Fork Insert</i> (Dana 30 w/ Disconnect) | 16527.14 |
| 33 1987-1995 Wrangler, <i>Axle Disconnect Shift Fork Snap Ring</i> (Dana 30 w/ Disconnect) | 16527.18 |
| 34 1984-1991 Cherokee, 1987-1995 Wrangler (Dana 30 w/ Disconnect), <i>Axle Disconnect Housing Cover Gasket</i> | 16527.19 |
| 35 1984-1991 Cherokee, 1987-1995 Wrangler, <i>Differential Cover Kit</i> (Dana 30 w/ Disconnect), Stainless Steel | 11118.01 |
| 36 1984-1991 Cherokee, 1987-1995 Wrangler, <i>Differential Cover Kit</i> (Dana 30 w/ Disconnect), Heavy Duty, Cast Steel | 16595.30 |
| 37 1984-1991 Cherokee, 1987-1995 Wrangler, <i>Differential Skid Plate</i> (Dana 30 w/ Disconnect), Heavy Duty, Cast Steel | 16597.30 |
| 37 1984-1991 Cherokee, 1987-1995 Wrangler, <i>Differential Skid Plate</i> (Dana 30 w/ Disconnect), Heavy Duty, Cast Steel | DMC-16597.30 |

All images are subject to be representative. More detailed information is available online.

| D. Front Dana 30 Without Disconnect | | Part# |
|-------------------------------------|--|----------|
| 1 | 1992-2001 Cherokee, 1993-1998 Cherokee, 1997-2011 Wrangler, <i>Rebuild Kit</i> [Dana 30] | 16501.03 |
| 2 | 1992-2001 Cherokee, 1993-1998 Cherokee, 1997-2011 Wrangler, <i>Differential Cover Gasket</i> [Dana 30] | 16502.01 |
| 3 | 1992-2001 Cherokee, 1993-1998 Cherokee, 1997-2011 Wrangler, <i>Standard Differential Case Kit, 2.75 to 3.54 Ratio</i> | 16503.04 |
| 3 | 1992-2001 Cherokee, 1993-1998 Cherokee, 1997-2011 Wrangler, <i>Standard Differential Case Kit (Dana 30), 3.73 to 5.38 Ratio</i> | 16503.05 |
| 3A | 1992-2001 Cherokee, 1993-1998 Cherokee, 1997-2011 Wrangler, <i>Spider Gear Kit</i> [Dana 30], With Standard Differential | 16507.04 |
| 3B | 1992-2001 Cherokee, 1993-1998 Cherokee, 1997-2011 Wrangler, <i>Cross Shaft</i> [Dana 30] | 16507.61 |
| 3B | 1999-2006 Wrangler, 1999 Cherokee, <i>Differential Case Assembly</i> [Dana 30], 3.07 to 3.55 Ratio | 16505.18 |
| 3B | 2002-2007 Liberty, <i>Differential Case Assembly</i> [Dana 30] 3.73 or 4.10 Ratio | 16503.52 |
| 3B | 2005-2006 Liberty, <i>Differential Case Assembly</i> [Dana 30], 3.55 Ratio | 16505.15 |
| 3B | 1999 Cherokee, <i>Differential Case Kit</i> [Dana 30], 3.07 to 3.55 Ratio | 16503.61 |
| 3C | 1992-2001 Cherokee, 1993-98 Grand Cherokee, 1997-2006 Wrangler, <i>Pinion Thrust Washer</i> [Dana 30] | 16584.06 |
| 4 | Wrangler, <i>Differential Side Bearing Kit</i> [Dana 30], Includes 2 Bearings & 2 Cups | 16509.05 |
| 4A | 1992-2001 Cherokee, 1993-1998 Cherokee, 1997-2011 Wrangler, <i>Differential Bearing Cap Bolt</i> [Dana 30] | 16584.11 |
| 5 | 1999-2001 Cherokee, <i>Differential Bearing Shim Set</i> [Dana 30] | 16512.05 |
| 5 | 1999-2006 Wrangler, <i>Differential Bearing Shim Set</i> [Dana 30] | 16512.06 |
| 5 | 1993-1998 Grand Cherokee, 1997-2006 Wrangler, <i>Side or Pinion Bearing Shim Kit</i> [Dana 30] | 16512.03 |
| 6 | 2007-2012 Wrangler, <i>Ring & Pinion</i> [Dana 30], 4.10 Ratio NEW | 16513.51 |
| 6 | 1992-2001 Cherokee, 1997-2006 Wrangler, <i>Ring & Pinion Kit</i> [Dana 30], 3.07 Ratio [34 x 14 Teeth] | 16513.30 |
| 6 | 1992-2001 Cherokee, 1997-2006 Wrangler, <i>Ring & Pinion Kit</i> [Dana 30], 3.55 Ratio [39 x 11 Teeth] | 16513.31 |
| 6 | 1992-2001 Cherokee, 1997-2006 Wrangler, <i>Ring & Pinion Kit</i> [Dana 30], 3.73 Ratio [41 x 11 Teeth] | 16513.32 |
| 6 | 1992-2001 Cherokee, 1997-2006 Wrangler, <i>Ring & Pinion Kit</i> [Dana 30], 4.10 Ratio [41 x 10 Teeth] | 16513.33 |
| 6 | 2001-2006 Wrangler, 2001 Cherokee, <i>Ring & Pinion Kit</i> [Dana 30], 3.07 Ratio [34 x 14] | 16514.36 |
| 6 | 1993-1996 Grand Cherokee, <i>Ring & Pinion Kit</i> [Dana 30], 3.55 Ratio [39 x 11] | 16513.38 |
| 6 | 1993-1996 Grand Cherokee, <i>Ring & Pinion Kit</i> [Dana 30], 3.55 Ratio [39 x 11] | 16513.39 |
| 6 | 1999-2003 Grand Cherokee, <i>Ring & Pinion</i> [Dana 30], 3.55 Ratio [39 x 11] | 16514.38 |
| 6 | 2000 Cherokee, <i>Ring & Pinion Kit</i> [Dana 30], 3.55 Ratio [41 x 11] | 16514.39 |
| 6 | 2001-2006 Wrangler, 2001 Cherokee, <i>Ring & Pinion Kit</i> [Dana 30], 3.55 Ratio [39 x 11] | 16514.47 |
| 6 | 2005-2006 Liberty, <i>Ring & Pinion</i> [Dana 30], 3.55 Ratio [39 x 11] | 16514.45 |
| 6 | 2000 Cherokee [2.5L Diesel], <i>Ring & Pinion Kit</i> [Dana 30], 3.73 Ratio [41 x 11], LHD or RHD | 16514.53 |
| 6 | 2002-2006 Wrangler, <i>Ring & Pinion</i> [Dana 30], 3.73 Ratio [41 x 11] | 16513.90 |
| 6 | 2002-2007 Liberty, <i>Ring & Pinion</i> [Dana 30], 3.73 Ratio [41 x 11] | 16514.50 |
| 6 | 2002-2006 Liberty, <i>Ring & Pinion</i> [Dana 30], 4.10 Ratio [41 x 10 Teeth] | 16514.44 |
| 6 | 2001-2004 Wrangler, <i>Ring & Pinion Kit</i> [Dana 30], 4.10 Ratio [41 x 10 Teeth] | 16514.42 |
| 6 | 1992-2001 Cherokee, 1997-2006 Wrangler, <i>Ring & Pinion</i> [Dana 30], 4.56 Ratio | 16513.34 |
| 6 | 1992-2001 Cherokee, 1997-2006 Wrangler, <i>Ring & Pinion</i> [Dana 30], 4.88 Ratio | 16513.35 |
| 7 | 1997-2011 Wrangler, 1992-2001 Cherokee, 1993-2004 Grand Cherokee 2002-2007 Liberty, <i>Outer Pinion Bearing Kit</i> [Dana 30], Includes: 1 Bearing & 1 Cup | 16517.02 |
| 8 | 1997-2011 Wrangler, 1992-2001 Cherokee, 1993-2004 Grand Cherokee 2002-2007 Liberty, <i>Outer Pinion Oil Slinger</i> [Dana 30] | 16512.52 |
| 8 | 2003-2011 Wrangler, <i>Inner & Outer Pinion Oil Slinger</i> [Dana 30] | 16512.61 |
| 8 | Pinion Slinger D30 KJ 02-06 JK NEW | 16512.66 |
| 9 | 1997-2011 Wrangler, 1992-2001 Cherokee, 1993-1998 Grand Cherokee, <i>Inner Pinion Bearing Kit</i> [Dana 30], Includes: 1 Bearing & 1 Cup | 16515.02 |
| 10 | 1997-2011 Wrangler, 1992-2001 Cherokee, 1993-1998 Grand Cherokee, <i>Inner Pinion Bearing Baffle</i> [Dana 30] | 16512.53 |
| 11 | 1997-2006 Wrangler, 1992-2001 Cherokee, 1996-1998 Grand Cherokee, <i>Collapsible Pinion Spacer</i> [Dana 30] | 16512.54 |
| 11 | 1997-2004 Wrangler, <i>Collapsible Pinion Spacer</i> [Dana 30] | 16512.63 |
| 11 | 2007-2011 Wrangler, <i>Pinion Crush Sleeve</i> [Dana 30] | 16512.65 |
| 12 | 1993-1998 Grand Cherokee, <i>Inner Oil Slinger</i> [Dana 30] | 16512.51 |
| 12 | 2003-2011 Wrangler, <i>Inner Pinion Oil Slinger</i> [Dana 30] | 16512.61 |
| 12 | 1999-2006 Wrangler, 1992-2001 Cherokee, <i>Inner Pinion Oil Slinger</i> [Dana 30] | 16512.58 |
| 13 | 1997-2011 Wrangler, 1992-2001 Cherokee, 1993-1998 Grand Cherokee, <i>Pinion Nut</i> [Dana 30] | 16584.01 |
| 13 | 2003-2006 Wrangler, <i>Pinion Nut</i> [Dana 30] | 16584.04 |
| 14 | 1997-2011 Wrangler, 1992-2001 Cherokee, 1993-1998 Grand Cherokee, <i>Pinion Washer</i> [Dana 30] | 16584.02 |
| 14 | 1997-2011 Wrangler, 1992-2001 Cherokee, 1993-1998 Grand Cherokee, <i>Pinion Oil Seal</i> [Dana 30] | 16521.01 |
| 15 | 1997-2011 Wrangler, 1992-2001 Cherokee, 1993-1998 Grand Cherokee, <i>Pinion Oil Seal</i> [Dana 30], National Brand | 16521.02 |
| 15 | 1997-2011 Wrangler, 1992-2001 Cherokee, 1993-1998 Grand Cherokee, <i>Flanged Pinion Oil Seal</i> [Dana 30] | 16521.12 |

Axle - Front Dana 30 Without Disconnect

1997-2011 Wrangler
1992-2001 Cherokee
1993-1998 Grand Cherokee

[1] 16501.03

[23] 16527.30

[25] 16595.30

[26] 16597.30

[20] 16523.09

You won't break this cover, we guarantee it. If you do, we'll replace it. Made of 3/8 inch cast steel, painted black inside and out, this heavy duty cover was designed to protect your differential and all its working parts for as long as you own your vehicle.

UPGRADE

| D. Front Dana 30 Without Disconnect | | Part# |
|-------------------------------------|---|----------|
| | Pinion Oil Seal Frt JK D30 D44 NEW | 16521.22 |
| 16 | 1992-2001 Cherokee, 1997-2006 TJ Wrangler, 1993-1998 Grand Cherokee, <i>Inner Axle Oil Seal</i> [Dana 30], LH or RH | 16526.02 |
| 17 | 1992-2001 Cherokee, 1993-1998 Grand Cherokee, 1997-2011 Wrangler, <i>Ring Gear Bolt</i> [Dana 30] | 16522.01 |
| 18 | 1992-2001 Cherokee, 1993-1998 Grand Cherokee, 1997-2006 Wrangler [Dana 30], <i>Yoke U-Bolt Style</i> [Dana 30 w/ Disconnect] | 16580.02 |
| 18 | 1992-2001 Cherokee, 1993-1998 Grand Cherokee, 1997-2006 Wrangler [Dana 30], <i>Yoke Strap & Bolt Style</i> [Dana 30 w/ Disconnect] | 16580.07 |
| 18A | 1992-2001 Cherokee, 1993-1998 Grand Cherokee, 1997-2006 Wrangler [Dana 30], <i>Yoke U-Bolt Pair</i> [Dana 30] | 16582.01 |
| 18A | 1992-2001 Cherokee, 1993-1998 Grand Cherokee, 1997-2006 Wrangler [Dana 30], <i>Yoke U-Bolt Pair</i> [Dana 30], Dana Spicer Brand | 16582.02 |
| 18B | 1992-2001 Cherokee, 1993-1998 Grand Cherokee, 1997-2006 Wrangler [Dana 30], <i>Yoke Strap & Bolt</i> [Dana 30] | 16582.03 |
| 19 | 1992-2001 Cherokee, 1993-1998 Grand Cherokee, 1997-2011 Wrangler [Dana 30], <i>U-Joint, Greasable, LH or RH</i> | 16525.04 |
| 19 | 1992-2001 Cherokee, 1993-1998 Grand Cherokee, 1997-2011 Wrangler [Dana 30], <i>U-Joint, Non-Greasable, LH or RH, Dana Spicer Brand</i> | 16525.05 |
| 19 | 1992-2001 Cherokee, 1993-1998 Grand Cherokee, 1997-2011 Wrangler [Dana 30], <i>U-Joint, Greasable, LH or RH, Dana Spicer Brand</i> | 16525.06 |
| 20 | 1997-2006 Wrangler, 1992-2001 Cherokee, <i>Axle Shaft Assembly</i> [Dana 30], RH Without ABS | 16523.16 |
| 20 | 1997-2006 Wrangler, 1992-2001 Cherokee, 1997-1998 Grand Cherokee, <i>Axle Shaft Assembly</i> [Dana 30], RH With ABS | 16523.18 |
| 20 | 1997-2006 Wrangler, 1992-2001 Cherokee, <i>Axle Shaft Assembly</i> [Dana 30], LH Without ABS | 16523.09 |
| 20 | 1997-2006 Wrangler, 1992-2001 Cherokee, 1997-1998 Grand Cherokee, <i>Axle Shaft Assembly</i> [Dana 30], RH With ABS | 16523.11 |
| 20 | 1993-1998 Grand Cherokee, <i>Axle Shaft Assembly</i> [Dana 30], RH, CV Style | 16523.20 |
| 20 | 1993-1998 Grand Cherokee, <i>Axle Shaft Assembly</i> [Dana 30], LH, CV Style | 16523.21 |
| 20 | 1993-1998 Grand Cherokee, <i>CV Axle (Stub) Shaft</i> [Dana 30], Outer LH or RH, CV Style | 16523.22 |
| 20 | 1997-2006 Wrangler, 1992-2001 Cherokee, 1997-1998 Grand Cherokee, <i>Axle Shaft Outer Dust Shield</i> [Dana 30], RH With ABS | 16527.21 |
| 21A | 1997-2006 Wrangler, 1992-2001 Cherokee, 1997-1998 Grand Cherokee, <i>Axle Tone Ring</i> [Dana 30], With ABS | 16527.42 |
| 22 | 1997-2006 Wrangler, 1992-2001 Cherokee, 1997-1998 Grand Cherokee, <i>Inner Axle Dust Shield</i> [Dana 30], LH or RH | 16527.22 |
| 22 | 1993-1998 Grand Cherokee, <i>Outer Axle Oil Slinger</i> [Dana 30] | 16512.57 |
| 23 | 1993-1998 Grand Cherokee, <i>CV Axle Boot Kit, LH or RH</i> [Dana 30] | 16527.30 |
| 24 | 1997-2011 Wrangler, 1992-2001 Cherokee, 1997-1998 Grand Cherokee, <i>Differential Cover Kit</i> [Dana 30] | 16595.81 |
| 24 | 2002-2007 Liberty, <i>Differential Cover Kit</i> [Dana 30] | 16595.82 |
| 25 | 1997-2011 Wrangler, 1992-2001 Cherokee, 1997-1998 Grand Cherokee, <i>Differential Cover Kit</i> [Dana 30], Heavy Duty, Cast Steel | 16595.30 |
| 26 | 1997-2011 Wrangler, 1992-2001 Cherokee, 1997-1998 Grand Cherokee, <i>Differential Skid Plate</i> [Dana 30], Heavy Duty, Cast Steel | 16597.30 |
| 26 | 1997-2011 Wrangler, 1992-2001 Cherokee, 1997-1998 Grand Cherokee, <i>Differential Skid Plate</i> [Dana 30], Heavy Duty, Cast Steel DMC | 16597.30 |
| 26 | 1997-2006 Wrangler, 1992-2001 Cherokee, 1997-1998 Grand Cherokee, <i>Differential Cover Drain Plug</i> [Dana 30] | 16595.95 |

Axle - Front Dana 30 & 44

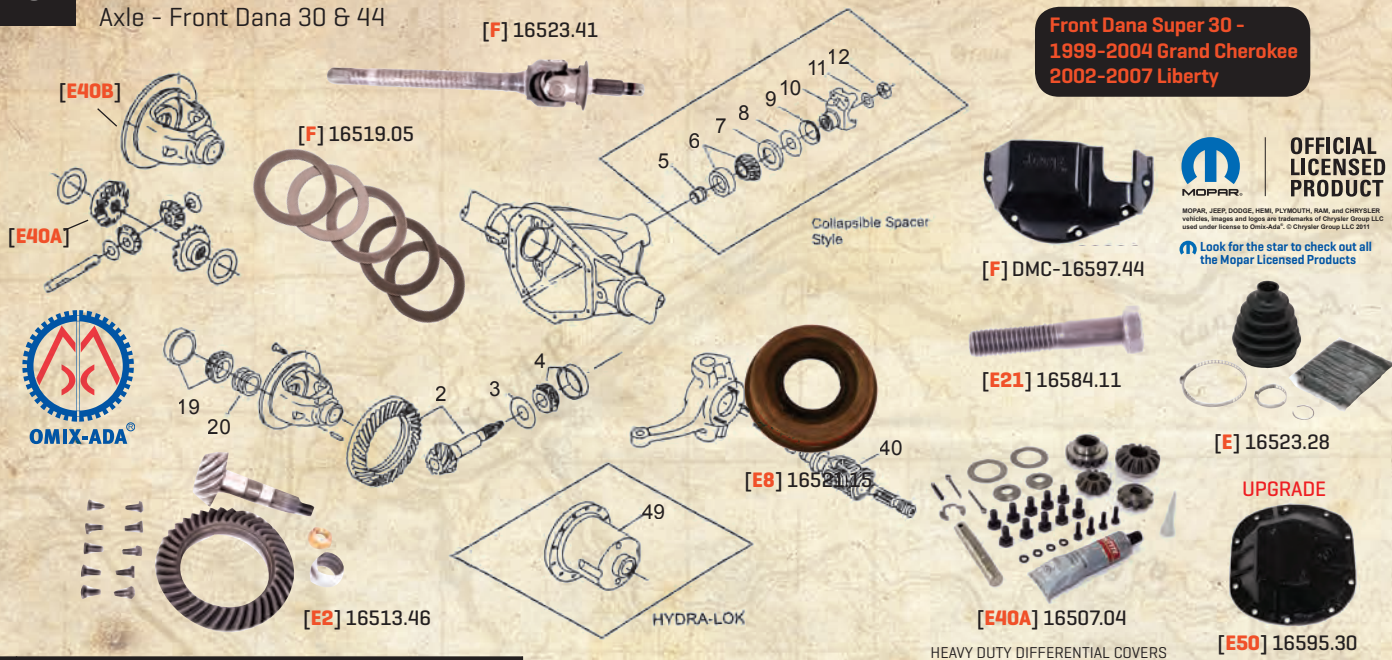

Front Dana Super 30 -
1999-2004 Grand Cherokee
2002-2007 Liberty

OFFICIAL LICENSED PRODUCT
MOPAR, JEEP, DODGE, RAM, PLYMOUTH, CHRYSLER, and CHRYSLER vehicles, images and logos are trademarks of Chrysler Group LLC used under license to Omix-Ada. © Chrysler Group LLC 2011
Look for the star to check out all the Mopar Licensed Products

E. Front Dana Super 30

| | Part# |
|---|----------|
| 2 1999-2004 Grand Cherokee, Ring & Pinion (Dana Super 30), 3.55 Ratio | 16513.45 |
| 2 1999-2004 Grand Cherokee, Ring & Pinion Kit (Dana Super 30), 3.73 Ratio | 16513.46 |
| 2 1999-2004 Grand Cherokee, Ring & Pinion (Dana Super 30), 3.91 Ratio | 16513.47 |
| 2 2005-2006 Liberty, Ring & Pinion (Dana 30), 3.55 Ratio [39 x 11] | 16514.45 |
| 2 2002-2007 Liberty, Ring & Pinion (Dana 30), 3.73 Ratio [41 x 11] | 16514.50 |
| 2 2002-2006 Liberty, Ring & Pinion (Dana 30), 4.10 Ratio [41 x 10 Teeth] | 16514.44 |
| 3 2002-2007 Liberty, Pinion Shim Kit (Dana Super 30) | 16512.08 |
| 3B 2002-2007 Liberty, Differential Case Assembly (Dana 30) 3.73 or 4.10 Ratio | 16503.52 |
| 3B 2005-2006 Liberty, Differential Case Assembly (Dana 30), 3.55 Ratio | 16505.15 |
| 4 1999-2004 Grand Cherokee, Inner Pinion Bearing Kit (Dana Super 30) | 16515.02 |
| 4 2002-2007 Liberty, Inner Pinion Bearing Kit (Dana Super 30) | 16512.68 |
| 5 1999-2000 Grand Cherokee, Collapsible Pinion Spacer (Dana Super 30) | 16512.54 |
| 5 2001-2004 Grand Cherokee, Collapsible Pinion Spacer (Dana Super 30) | 16512.63 |
| 6 1999-2004 Grand Cherokee 2002-2007 Liberty, Outer Pinion Bearing (Dana Super 30), Includes: 1 Bearing & 1 Cup | 16517.02 |
| 7 2002-2007 Liberty, Outer Pinion Oil Slinger (Dana Super 30) | 16512.52 |
| 7 2002-2006 Liberty, Pinion Bearing Slinger (Dana Super 30) NEW | 16512.66 |
| 8 1999-2000 Grand Cherokee, Inner Pinion Seal (Dana Super 30) | 16521.03 |
| 8 2001-2004 Grand Cherokee, Inner Pinion Oil Seal (Dana Super 30) | 16521.15 |
| 9 1999-2004 Grand Cherokee, Outer Pinion Seal (Dana Super 30) | 16521.04 |
| 10 1999-2004 Grand Cherokee, 2002-2007 Liberty, Yoke (Dana Super 30) | 16580.56 |
| 11 1999-2004 Grand Cherokee, 2002-2007 Liberty, Pinion Washer (Dana Super 30) | 16584.02 |
| 12 1999-2004 Grand Cherokee, 2002-2007 Liberty, Pinion Nut (Dana Super 30) | 16584.01 |
| 19 2002-2007 Liberty, Differential Side Bearing Kit (Dana Super 30), Includes: 2 Bearings & 2 Cups | 16509.05 |
| 20 1999-2004 Grand Cherokee, Differential Seal Kit (Dana Super 30) | 16511.02 |
| 21 1999-2004 Grand Cherokee, 2002-2007 Liberty, Differential Bearing Cap Bolt (Dana Super 30) | 16584.11 |
| 2002-2007 Liberty, Differential Parts Kit (Dana Super 30) | 16509.09 |
| 40 1999-2004 Grand Cherokee, CV Axle Shaft Assembly (Dana Super 30), Front LH With Vari-Lok & ABS | 16523.37 |
| 40 2002-2007 Liberty, Axle Shaft (Dana Super 30), Front Inner, LH or RH | 16523.43 |
| 40 1999-2004 Grand Cherokee, CV Axle Shaft Assembly (Dana Super 30), Front RH With ABS | 16523.32 |
| 40 1999-2004 Grand Cherokee, CV Axle Shaft Assembly (Dana Super 30), Front LH With ABS | 16523.33 |
| 40 1999-2004 Grand Cherokee, CV Axle Shaft Assembly (Dana Super 30), Front RH With Vari-Lok & ABS | 16523.34 |
| 40 1999-2004 Grand Cherokee, CV Joint (Dana Super 30), Front LH or RH | 16523.23 |
| 40 2002-2007 Liberty, Axle Bearing (Dana Super 30) | 16536.32 |
| 40 2002-2009 Liberty, Axle Shaft Oil Seal (Dana Super 30) | 16534.12 |
| 40 2002-2009 Liberty, Axle Snap Ring (Dana Super 30) | 16536.23 |
| 40A 2002-2009 Liberty, Spider Gear Set (Dana Super 30) | 16507.04 |
| 40B 1999-2004 Grand Cherokee, Standard Differential Case Assembly (Dana Super 30), 3.55 Ratio | 16505.07 |

You won't break these covers, we guarantee it, if you do, we'll replace them. Made of 3/8 inch cast steel, painted black inside and out, these heavy duty covers are designed to protect your differential and all its working parts for as long as you own your vehicle. These covers even have reinforced protection for the fill plug. All mounting hardware and instructions are included.

E. Front Dana Super 30

| | Part# |
|--|--------------|
| 40B 1999-2004 Grand Cherokee, Standard Differential Case Assembly (Dana Super 30), 3.73 to 3.91 Ratio | 16505.08 |
| 40B 1999-2004 Grand Cherokee, Differential Case Assembly (Dana Super 30), With Vari-Lok, 3.73 to 3.91 Ratio | 16503.62 |
| 49 1999-2004 Grand Cherokee, Vari-Lok 3.73 and UP Ratio (Dana Super 30) | 16505.09 |
| 49 1999-2004 Grand Cherokee, Vari-Lok Axle Plenum (Dana Super 30) | 16508.40 |
| 50 2002-2007 Liberty, Differential Cover Kit (Dana 30) | 16595.82 |
| 50 1999-2004 Grand Cherokee, 2002-2007 Liberty, Differential Cover Kit (Dana Super 30), Heavy Duty, Cast Steel UPGRADE | 16595.30 |
| 50 1999-2004 Grand Cherokee, 2002-2007 Liberty, Differential Skid Plate (Dana Super 30), Heavy Duty, Cast Steel UPGRADE | DMC-16597.30 |
| 51 1999-2004 Grand Cherokee, 2002-2007 Liberty, Differential Skid Plate (Dana Super 30), Heavy Duty, Cast Steel UPGRADE | 16597.30 |
| 2002-2007 Liberty, Pinion Oil Seal (Dana Super 30) NEW | 16521.17 |
| 2002-2007 Liberty, CV Axle Boot Kit (Dana Super 30), Inner NEW | 16523.24 |
| 40 2002-2007 Liberty, CV Axle Boot Kit (Dana Super 30), Outer NEW | 16523.25 |
| 40 2002-2007 Liberty, Axle Shaft Assembly (Dana Super 30), RH NEW | 16523.26 |
| 2002-2007 Liberty, Axle Shaft Assembly (Dana Super 30), LH NEW | 16523.27 |
| 2005-2010 Grand Cherokee, CV Axle Boot Kit (Dana Super 30), Inner NEW | 16523.28 |
| 2005-2010 Grand Cherokee, CV Axle Boot Kit (Dana Super 30), Outer NEW | 16523.29 |
| 2005-2010 Grand Cherokee, Axle Shaft Assembly (Dana Super 30), RH With or Without Limited Slip Differential NEW | 16523.50 |
| 2005-2010 Grand Cherokee, Axle Shaft Assembly (Dana Super 30), LH Without Limited Slip Differential NEW | 16523.51 |
| 40 2005-2010 Grand Cherokee, Axle Shaft Assembly (Dana Super 30), LH With Limited Slip Differential NEW | 16523.53 |

F. 2003-2011 Wrangler Front Dana 44

| | Part# |
|--|--------------|
| 2003-2006 Wrangler, Inner Pinion Oil Seal (Dana 44 Front) | 16521.15 |
| 2003-2006 Wrangler, Pinion Nut (Dana 44 Front) | 16584.04 |
| 2003-2012 Wrangler, Inner & Outer Pinion Oil Slinger (Dana 44 Front) | 16512.61 |
| 2003-2012 Wrangler, Pinion Shim Kit [0.050-0.054] (Dana 44 Front) | 16519.05 |
| 2003-2012 Wrangler, Pinion Shim Kit [0.035-0.039] (Dana 44 Front) | 16519.02 |
| 2003-2012 Wrangler, Pinion Shim Kit [0.040-0.044] (Dana 44 Front) | 16519.03 |
| 2003-2012 Wrangler, Pinion Shim Kit [0.045-0.049] (Dana 44 Front) | 16519.04 |
| 2007-2012 Wrangler, Pinion Crush Sleeve (Dana 44 Front) | 16512.65 |
| 2003-2006 Wrangler, Dana 44 with Trac Lok Air Locker, Ring and Pinion, 4.10 Ratio (Dana 44 Front) | 16514.43 |
| 2003-2006 Wrangler, Differential Case Assembly, 4.10-4.56 Ratio (Dana 44 Front) | 16505.26 |
| 1997-2012 Wrangler, Differential Bearing Cap Bolt (Dana 44 Front) | 16584.11 |
| 2001-2006 Wrangler, Differential Cover Gasket (Dana 44 Front) | 16502.05 |
| 2003-2006 Wrangler, Axle Shaft Assembly (Dana 44 Front), Left | 16523.41 |
| 2003-2006 Wrangler, Axle Shaft Assembly (Dana 44 Front), Right | 16523.46 |
| 2007-2012 Wrangler, Ring & Pinion (Front Dana 44), 4.10 Ratio NEW | 16513.50 |
| 1972-1983 CJ5, 1972-1975 CJ6, 1986 CJ7, 1987-2011 Wrangler, 1993-1998 Grand Cherokee, Differential Skid Plate (Rear Dana 44), Heavy Duty, Cast Steel | 16597.44 |
| Differential Skid Plate, Heavy Duty, Jeep Logo, Dana 44, Mopar Licensed | DMC-16597.44 |

All images are subject to be representative. More detailed information is available online.

Axle

Axle - Rear Dana 27 & Rear Dana 44 with Tapered Axles

Rear Dana 44 w/ Tapered Axles -
 1950-1953 CJ3A, 1950-1952 M38, 1952-1971 M38A1, 1946-1964 Truck,
 1946-1964 Station Wagon, 1953-1967 CJ3B, 1955-1971 CJ5, 1955-1971 CJ6



Rear Dana 27
 1941-1945 MB,
 1941-1945 GPW

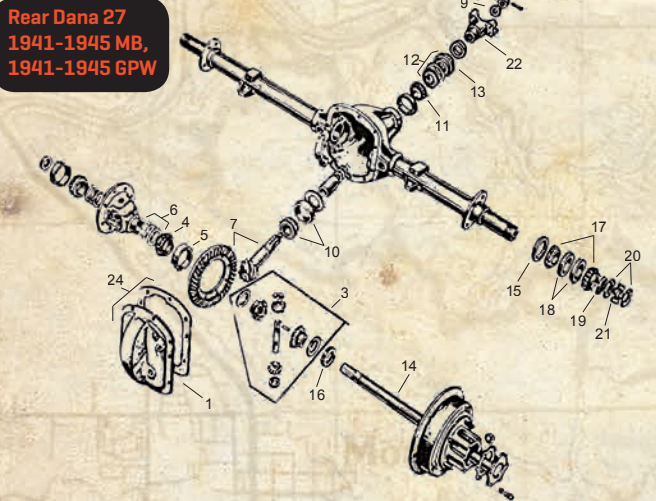

| G. Rear Dana 27 | | Part# |
|-----------------|---|----------|
| 1 | 1941-1945 MB, 1941-1945 Ford GPW, Differential Cover Gasket [Dana 27 Rear] | 16502.01 |
| 3 | 1941-1945 MB, 1941-1945 Ford GPW, Spider Gear Kit for Standard Differential [Dana 27 Rear] | 16507.01 |
| 4 | 1941-1945 MB, 1941-1945 Ford GPW, Differential Side Bearing [Dana 27 Rear], [2 Required] | 16509.01 |
| 5 | 1941-1945 MB, 1941-1945 Ford GPW, Differential Side Bearing Cup [Dana 27 Rear], [2 Required] | 16509.03 |
| 6 | 1941-1945 MB, 1941-1945 Ford GPW, Differential Side Bearing Shim Kit [Dana 27 Rear] | 16511.01 |
| 7 | 1941-1945 MB, 1941-1945 Ford GPW, Ring & Pinion, 4.88 Ratio [Dana 27 Rear], 39 x 8 Teeth | 16513.02 |
| 8 | 1941-1945 MB, 1941-1945 Ford GPW, Pinion Nut [Dana 27 Rear] | 16584.01 |
| 9 | 1941-1945 MB, 1941-1945 Ford GPW, Pinion Washer [Dana 27 Rear] | 16584.02 |
| 10 | 1941-1945 MB, 1941-1945 Ford GPW, Inner Pinion Bearing [Dana 27 Rear] | 16515.01 |
| 11 | 1941-1945 MB, 1941-1945 Ford GPW, Outer Pinion Bearing [Dana 27 Rear] | 16517.01 |
| 12 | 1941-1945 MB, 1941-1945 Ford GPW, Pinion Bearing Shim Kit [Dana 27 Rear] | 16519.01 |
| 13 | 1941-1945 MB, 1941-1945 Ford GPW, Pinion Oil Seal [Dana 27 Rear] | 16521.01 |
| 14 | 1941-1945 MB, 1941-1945 Ford GPW, Axle Shaft, RH [Dana 27 Rear] | 16530.02 |
| 15 | 1941-1945 MB, 1941-1945 Ford GPW, Outer Wheel Oil Seal [Dana 27 Rear] | 16708.01 |
| 16 | 1941-1945 MB, 1941-1945 Ford GPW, Inner Axle Oil Seal [Dana 27 Rear] | 16526.01 |
| 17 | 1941-1945 MB, 1941-1945 Ford GPW, Axle Shaft Hub Bearing [Dana 27 Rear], Inner or Outer | 16706.01 |
| 18 | 1941-1945 MB, 1941-1945 Ford GPW, Axle Shaft Hub Bearing Cap [Dana 27 Rear], Inner or Outer | 16707.01 |
| 19 | 1941-1945 MB, 1941-1945 Ford GPW, Wheel Bearing Lock Washer [Dana 27 Rear] | 16710.02 |
| 20 | 1941-1945 MB, 1941-1945 Ford GPW, Wheel Bearing Nut [Dana 27 Rear] | 16710.03 |
| 21 | 1941-1945 MB, 1941-1945 Ford GPW, Wheel Bearing Nut Washer [Dana 27 Rear] | 16710.04 |
| 21 | 1941-1945 MB, 1941-1945 Ford GPW, Spindle Nut and Washer Kit [Dana 27 Rear], Includes: 2 Nuts & 2 Washers | 16710.01 |
| 22 | 1941-1945 MB, 1941-1945 Ford GPW, Pinion Shaft Yoke [Dana 27 Rear], 10 Spline | 16580.04 |
| 25 | 1941-1945 MB, 1941-1945 Ford GPW, Yoke U-Bolts, [Dana 27 Rear], 10 Spline, Pair | 16582.01 |
| 25 | 1941-1945 MB, 1941-1945 Ford GPW, Yoke U-Bolts [Dana 27 Rear], Pair [Spicer] | 16582.02 |

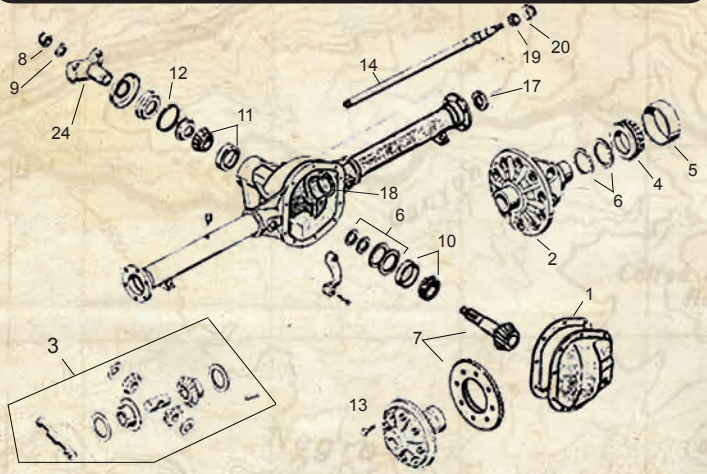

H. Rear Dana 44 With Tapered Axles Part#

| | | |
|----|--|----------|
| 1 | 1950-1971 Models, Differential Cover Gasket Rear [Dana 44 W/ Tapered Axles] | 16502.02 |
| 2 | 1950-1971 Models, Standard Differential Case [Dana 44 W/ Tapered Axles], 3.92 to 5.38 Ratio | 16503.20 |
| 3 | 1951 Truck, 1946-1951 Station Wagon, Differential Spider Gear Kit [Dana 44 W/ Tapered Axles], 10 Spline | 16507.15 |
| 3 | 1952-1964 Truck, 1952-1964 Station Wagon, 1953-1967 CJ3B, 1955-1971 C55, 1955-1971 CJ6, Differential Spider Gear Kit [Dana 44 W/ Tapered Axles], 19 Spline | 16507.16 |
| 4 | 1950-1971 Models, Rear Dana 44, Differential Side Bearing [Dana 44 W/ Tapered Axles], [2 Required] | 16509.20 |
| 5 | 1950-1971 Models, Rear Dana 44, Differential Cup [Dana 44 W/ Tapered Axles], [2 Required] | 16509.21 |
| 6 | 1950-1971 Models, Differential Side & Pinion Bearing Shim Kit [Dana 44 W/ Tapered Axles] | 16512.20 |
| 7 | 1950-1971 Models, Ring & Pinion [Dana 44 W/ Tapered Axles], 5.38 Ratio (43x8 Teeth), 10 Spline | 16513.60 |
| 7 | 1950-1971 Models, Ring & Pinion [Dana 44 W/ Tapered Axles], 4.27 Ratio (47x11 Teeth), 10 Spline | 16513.61 |
| 7 | 1950-1971 Models, Ring & Pinion [Dana 44 W/ Tapered Axles], 3.73 Ratio (41x11 Teeth), 26 Spline | 16513.62 |
| 8 | 1950-1971 Models, Pinion Nut [Dana 44 W/ Tapered Axles] | 16584.01 |
| 9 | 1950-1971 Models, Pinion Washer [Dana 44 W/ Tapered Axles] | 16584.02 |
| 10 | 1950-1971 Models, Inner Pinion Bearing and Cup Kit [Dana 44 W/ Tapered Axles] | 16515.01 |
| 11 | 1950-1971 Models, Outer Pinion Bearing and Cup Kit [Dana 44 W/ Tapered Axles] | 16517.01 |
| 12 | 1950-1971 Models, Pinion Oil Seal [Dana 44 W/ Tapered Axles] | 16521.01 |
| 13 | 1950-1971 Models, Ring Gear Bolt [Dana 44 W/ Tapered Axles] | 16522.01 |
| 14 | 1948-1969 CJ, Rear Dana 44, Axle Shaft [Dana 44 W/ Tapered Axles], Front RH, 10 Spline | 16530.04 |
| 14 | 1948-1969 CJ, Rear Dana 44, Axle Shaft [Dana 44 W/ Tapered Axles], Front RH, 19 Spline | 16530.06 |
| 14 | 1948-1969 CJ, Rear Dana 44, Axle Shaft [Dana 44 W/ Tapered Axles], Front LH, 10 Spline | 16530.03 |
| 14 | 1948-1969 CJ, Rear Dana 44, Axle Shaft [Dana 44 W/ Tapered Axles], Front LH, 19 Spline | 16530.05 |
| 15 | 1950-1971 Models, Axle Shaft Nut [Dana 44 W/ Tapered Axles] | 16533.01 |
| 16 | 1950-1971 Models, Axle Hub Key [Dana 44 W/ Tapered Axles] | 16533.02 |
| 16 | 1950-1971 Models, Oversized Axle Hub Key [Dana 44 W/ Tapered Axles], For Use with Worn Hub Key Area | 16533.12 |
| 17 | 1950-1971 Models, Rear Outer Axle Oil Seal [Dana 44 W/ Tapered Axles] | 16534.01 |
| 18 | 1948-1969 CJ, Rear Dana 44, Rear Inner Axle Oil Seal [Dana 44 W/ Tapered Axles] | 16535.01 |
| 19 | 1950-1971 Models, Inner Rear Output Shaft Bearing [Dana 44 W/ Tapered Axles] | 16536.01 |
| 20 | 1950-1971 Models, Inner Rear Output Shaft Cup [Dana 44 W/ Tapered Axles] | 16536.02 |
| 21 | 1950-1971 Models, Shim Kit Rear Axle Shaft Retainer [Dana 44 W/ Tapered Axles] | 16533.03 |
| 22 | 1950-1971 Models, Rear Axle Hub [Dana 44 W/ Tapered Axles] | 16537.01 |
| 24 | 1950-1971 Models, Yoke [Dana 44 W/ Tapered Axles], 10 Spline | 16580.04 |
| 24 | 1950-1971 Models, Yoke [Dana 44 W/ Tapered Axles], 26 Spline | 16580.02 |
| 25 | 1950-1971 Models, Yoke U-Bolt [Dana 44 W/ Tapered Axles], Pair | 16582.01 |
| 25 | 1950-1971 Models, Yoke U-Bolt [Dana 44 W/ Tapered Axles], Pair, Dana Spicer Brand | 16582.02 |

All images are subject to be representative. More detailed information is available online.

Axle

Rear Dana 44 w/
Flanged Axles -
1972-1975 CJ5,
1972-1975 CJ6, 1986 CJ7,
1987-2011 Wrangler,
1986-1993 Cherokee,
1993-1998 Grand Cherokee

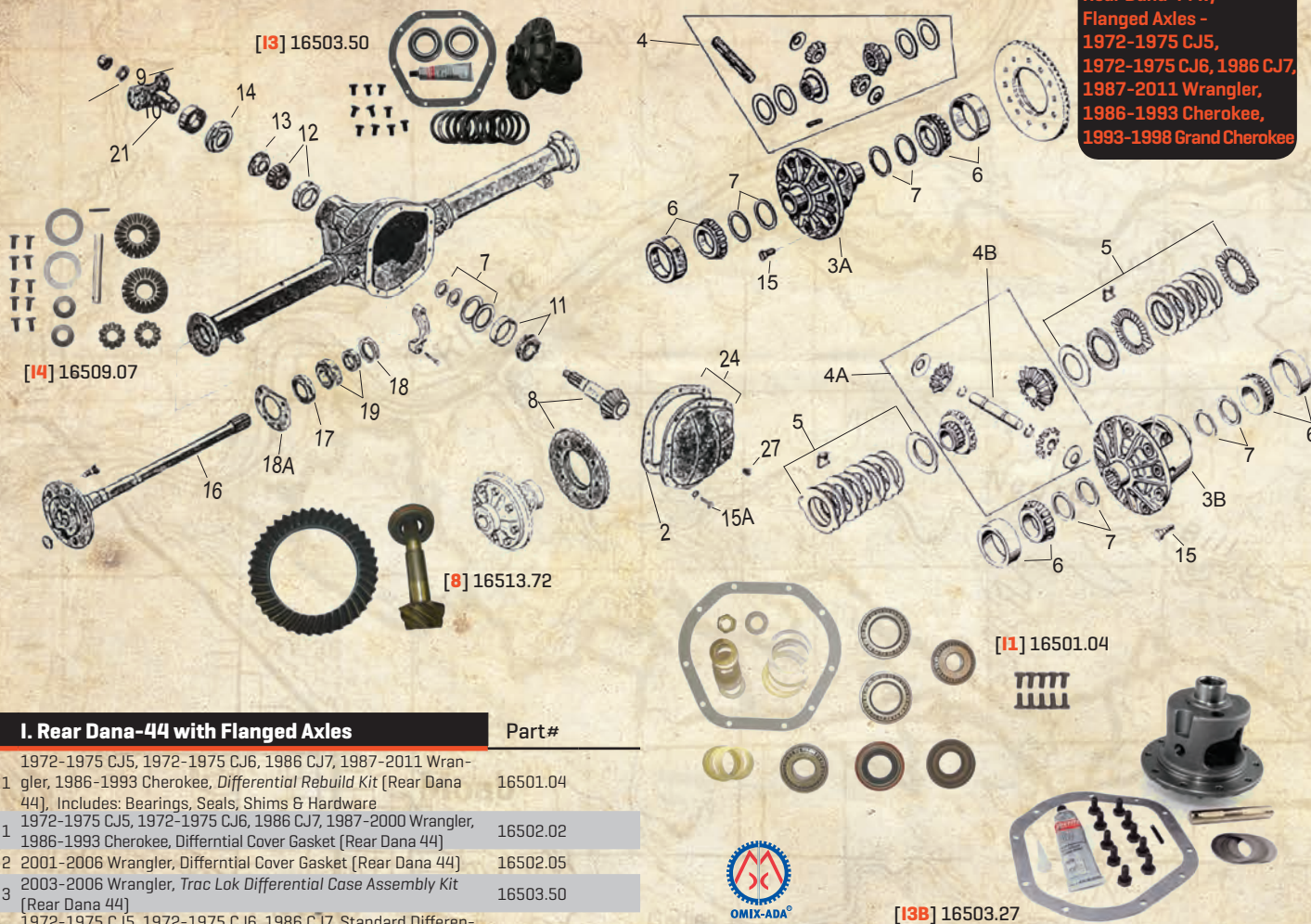

I. Rear Dana-44 with Flanged Axles

Part#

| | | |
|----|---|----------|
| 1 | 1972-1975 CJ5, 1972-1975 CJ6, 1986 CJ7, 1987-2011 Wrangler, 1986-1993 Cherokee, <i>Differential Rebuild Kit</i> [Rear Dana 44], Includes: Bearings, Seals, Shims & Hardware | 16501.04 |
| 1 | 1972-1975 CJ5, 1972-1975 CJ6, 1986 CJ7, 1987-2000 Wrangler, 1986-1993 Cherokee, <i>Differential Cover Gasket</i> [Rear Dana 44] | 16502.02 |
| 2 | 2001-2006 Wrangler, <i>Differential Cover Gasket</i> [Rear Dana 44] | 16502.05 |
| 3 | 2003-2006 Wrangler, <i>Trac Lok Differential Case Assembly Kit</i> [Rear Dana 44] | 16503.50 |
| 3A | 1972-1975 CJ5, 1972-1975 CJ6, 1986 CJ7, <i>Standard Differential Case</i> [Rear Dana 44], 2.87 to 3.73 Ratio | 16503.25 |
| 3A | 1972-1975 CJ5, 1972-1975 CJ6, 1986 CJ7, <i>Standard Differential Case</i> [Rear Dana 44], 3.92 to 5.38 Ratio | 16503.26 |
| 3A | 1987-1995 Wrangler, <i>Standard Differential Case</i> [Rear Dana 44], 3.07 to 3.54 Ratio | 16505.13 |
| 3A | 2001-2003 Wrangler, <i>Standard Differential Case Kit</i> [Rear Dana 44], 3.73 Ratio | 16503.65 |
| 3B | 2001-2003 Wrangler, <i>Trac Lok Differential Case Kit</i> [Rear Dana 44], 3.73 Ratio | 16503.27 |
| 3B | 1972-1975 CJ5, 1972-1975 CJ6, 1986 CJ7, <i>Trac Lok Differential Case Kit</i> [Rear Dana 44], 3.92 to 5.38 Ratio | 16503.28 |
| 3B | 1987-1995 Wrangler, <i>Trac Lok Differential Case Assembly Kit</i> [Rear Dana 44], 3.07 to 3.54 Ratio | 16505.10 |
| 3B | 1997-2006 Wrangler, <i>Trac Lok Differential Case Assembly Kit</i> [Rear Dana 44], 3.07 to 3.54 Ratio, Except Rubicon | 16503.27 |
| 3B | 1997-2006 Wrangler, <i>Trac Lok Differential Case</i> [Rear Dana 44], 3.07 to 3.54 Ratio | 16505.27 |
| 4 | 1972-1975 CJ5, 1972-1975 CJ6, 1986 CJ7, <i>Spider Gear Set</i> for Standard Differential [Rear Dana 44] | 16507.17 |
| 4 | 2001-2006 Wrangler, <i>Spider Gear Kit</i> for Standard Differential [Rear Dana 44] | 16509.07 |
| 4A | 1972-1975 CJ5, 1972-1975 CJ6, 1986 CJ7 [With Rear Disc Brakes], <i>Spider Gear Kit</i> for Standard Differential [Rear Dana 44] | 16507.18 |
| 4A | 1987-2006 Wrangler, <i>Spider Gear Kit with Disk Kit</i> [Rear Dana 44] | 16507.19 |
| 4A | 2001-2006 Wrangler, <i>Spider Gear Kit</i> for Trac Lok [Rear Dana 44] | 16509.08 |
| 4B | 1987-1995 Wrangler, <i>Differential Cross Shaft</i> [Rear Dana 44] NEW | 16507.60 |
| 5 | 1972-1975 CJ5, 1972-1975 CJ6, 1987-2006 Wrangler, <i>Trac Lok Disk Kit</i> [Rear Dana 44] | 16508.01 |
| 6 | 1972-1975 CJ5, 1972-1975 CJ6, 1986 CJ7, 1987-2010 Wrangler, 1986-1993 Cherokee, <i>Differential Side Bearing Kit</i> [Rear Dana 44], Includes: 2 Bearings & 2 Cups | 16509.22 |
| 7 | 2003-2011 Wrangler, <i>Pinion Shim Kit</i> [Rear Dana 44], [0.035-0.039"] | 16519.02 |
| 7 | 2003-2010 Wrangler, <i>Pinion Shim Kit</i> [Rear Dana 44], [0.040-0.044"] | 16519.03 |
| 7 | 2003-2010 Wrangler, <i>Pinion Shim Kit</i> [Rear Dana 44], [0.015-0.049"] | 16519.04 |
| 7 | 2003-2010 Wrangler, <i>Pinion Shim Kit</i> [Rear Dana 44], [0.050-0.054"] | 16519.05 |
| 7 | 2003-2006 Wrangler, <i>Pinion Bearing Shim Kit</i> [Rear Dana 44], 25 Pieces | 16519.06 |
| 7 | 2001-2003 Wrangler, <i>Differential Side Shim Kit</i> [Rear Dana 44] | 16512.07 |
| 7 | 1972-1975 CJ5, 1972-1975 CJ6, 1986 CJ7, 1987-2000 Wrangler, 1986-1993 Cherokee, <i>Differential Side & Pinion Bearing Shim Kit</i> [Rear Dana 44] | 16512.20 |
| 7 | 2003-2006 Wrangler Rubicon, <i>Differential Shim Kit</i> [Rear Dana 44] | 16519.08 |

I. Rear Dana-44 with Flanged Axles

Part#

| | | |
|----|--|----------|
| 8 | 1972-1975 CJ5, 1972-1975 CJ6, 1986 CJ7, <i>Ring & Pinion Kit</i> [Rear Dana 44], 3.31 Ratio | 16513.65 |
| 8 | 1972-1975 CJ5, 1972-1975 CJ6, 1986 CJ7, <i>Ring & Pinion Kit</i> [Rear Dana 44], 3.54 Ratio | 16513.66 |
| 8 | 1986-1993 Cherokee, <i>Ring & Pinion</i> [Rear Dana 44], 3.54 Ratio | 16514.32 |
| 8 | 1997-2006 Wrangler, <i>Ring & Pinion</i> [Rear Dana 44], 3.55 Ratio | 16513.67 |
| 8 | 1972-1975 CJ5, 1972-1975 CJ6, 1986 CJ7, 1987-2006 Wrangler, <i>Ring & Pinion</i> [Rear Dana 44], 3.73 Ratio | 16513.62 |
| 8 | 1972-1975 CJ, 1986 CJ7, <i>Ring & Pinion Kit</i> [Rear Dana 44], 4.09 Ratio | 16513.68 |
| 8 | 1991-1995 Wrangler, 1986-1993 Cherokee, <i>Ring & Pinion</i> [Rear Dana 44], 4.09 Ratio | 16514.31 |
| 8 | 1997-2003 Wrangler, <i>Ring & Pinion</i> [Rear Dana 44], 4.10 Ratio | 16513.69 |
| 8 | 1972-1975 CJ, 1986 CJ7, <i>Ring & Pinion</i> [Rear Dana 44], 4.27 Ratio | 16513.70 |
| 8 | 1972-1975 CJ, 1986 CJ7, <i>Ring & Pinion Kit</i> [Rear Dana 44], 4.55 Ratio | 16513.71 |
| 8 | 1972-1975 CJ, 1986 CJ7, <i>Ring & Pinion</i> [Rear Dana 44], 4.89 Ratio | 16513.72 |
| 8 | 2003-2006 Wrangler Rubicon, <i>Ring & Pinion</i> [Rear Dana 44], 4.89 Ratio | 16513.75 |
| 8 | 1972-1975 CJ, 1986 CJ7, <i>Ring & Pinion</i> [Rear Dana 44], 5.38 Ratio | 16513.73 |
| 8 | 2001-2003 Wrangler, <i>Ring & Pinion Kit</i> [Rear Dana 44], 3.07 Ratio | 16514.41 |
| 8 | 2003-2006 Wrangler, <i>Ring & Pinion Kit</i> [Rear Dana 44], 3.73 Ratio | 16514.55 |
| 8 | 2003-2006 Wrangler, <i>Ring & Pinion Kit</i> [Rear Dana 44], 4.10 Ratio | 16514.43 |
| 8 | 2007-2012 Wrangler, <i>Ring & Pinion Kit</i> [Rear Dana 44], 4.10 Ratio NEW | 16513.52 |
| 9 | 1972-1975 CJ5, 1972-1975 CJ6, 1986 CJ7, 1987-2000 Wrangler, 1986-1993 Cherokee, 1993-1998 Grand Cherokee, <i>Pinion Nut</i> [Rear Dana 44] | 16584.01 |
| 9 | 2003-2006 Wrangler, <i>Pinion Nut</i> [Rear Dana 44] | 16584.04 |
| 10 | 1972-1975 CJ5, 1972-1975 CJ6, 1986 CJ7, 1987-2011 Wrangler, 1986-1993 Cherokee, 1993-1998 Grand Cherokee, <i>Pinion Washer</i> [Rear Dana 44] | 16584.02 |
| 10 | 2001-2006 Wrangler, <i>Pinion Thrust Washer</i> [Rear Dana 44] | 16584.09 |
| 11 | 1986-1993 Cherokee, 1993-1998 Grand Cherokee, <i>Inner Pinion Bearing & Cup Kit</i> [Rear Dana 44] | 16515.01 |
| 12 | 1972-1975 CJ5, 1972-1975 CJ6, 1986 CJ7, 1987-2010 Wrangler, 1986-1993 Cherokee, 1993-1998 Grand Cherokee, <i>Outer Pinion Bearing & Cup Kit</i> [Rear Dana 44] | 16517.01 |

All images are subject to be representative. More detailed information is available online.

Rear Dana 44 w/ Flanged Axles -
1972-1975 CJ5, 1972-1975 CJ6, 1986 CJ7,
1987-2011 Wrangler, 1986-1993 Cherokee,
1993-1998 Grand Cherokee



OFFICIAL LICENSED PRODUCT

MOPAR, JEEP, DODGE, HEM, PLYMOUTH, RAM, and CHRYSLER vehicles, images and logos are trademarks of Chrysler Group LLC used under license to Omix-Ada®. © Chrysler Group LLC 2011

Look for the star to check out all the Mopar Licensed Products



[23] 16582.03



[22] 16582.01



[26] DMC-16597.44



[27] 16595.96



[17] 16534.02



[14] 16521.08

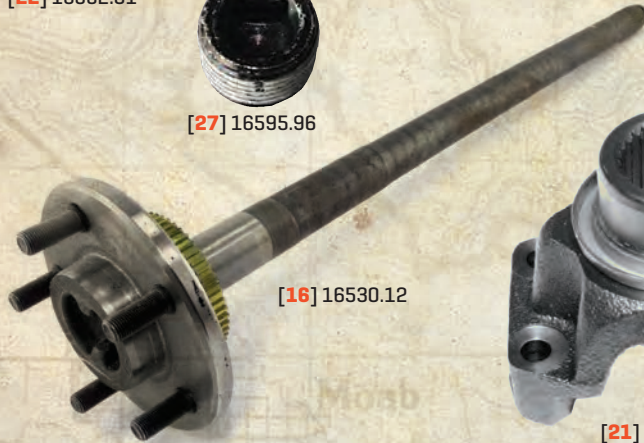

[16] 16530.12



[21] 16580.02



[25] 16595.44

I. Rear Dana-44 with Flanged Axles (Cont.)

Part#

| | | |
|-----|--|----------|
| 13 | 1972-1975 CJ5, 1972-1975 CJ6, 1986 CJ7, 1987-2006 Wrangler, 1986-1993 Cherokee, 1993-1998 Grand Cherokee, Outer Pinion Oil Slinger [Rear Dana 44] | 16512.52 |
| 13 | 2007-2011 Wrangler, Collapsible Pinion Spacer [Rear Dana 44] | 16512.67 |
| 14 | 1972-1975 CJ5, 1972-1975 CJ6, 1986 CJ7, 1987-1990 Wrangler, 1986-1993 Cherokee, 1993-1998 Grand Cherokee, Pinion Oil Seal [Rear Dana 44] | 16521.01 |
| 14 | 1972-1975 CJ5, 1972-1975 CJ6, 1986 CJ7, 1987-1990 Wrangler, 1986-1993 Cherokee, 1993-1998 Grand Cherokee, Pinion Oil Seal [Rear Dana 44], National Brand | 16521.02 |
| 14 | 1991-2000 Wrangler, 1986-1993 Cherokee, 1993-1998 Grand Cherokee, Pinion Oil Seal [Rear Dana 44] | 16521.08 |
| 14 | 2001-2011 Wrangler, Pinion Oil Seal [Rear Dana 44], Flanged | 16521.12 |
| 15 | 1972-1975 CJ5, 1972-1975 CJ6, 1986 CJ7, 1986-1993 Cherokee, 1987-2011 Wrangler, 1993-2004 Grand Cherokee, Ring Gear Bolt [Rear Dana 44] | 16522.01 |
| 15A | 1972-1986 CJ, 1987-2010 Wrangler, 1986-1993 Cherokee, 1993-2004 Grand Cherokee, Differential Cover Bolt [Rear Dana 44] | 16522.02 |
| 16 | 1972-1975 CJ5, 1972-1975 CJ6, Axle Shaft [Rear Dana 44] LH or RH | 16530.07 |
| 16 | 1972-1975 CJ5, 1972-1975 CJ6, Axle Shaft Kit [Rear Dana 44] LH or RH [Does one Side], Includes: 1 Shaft, Bearing & Seals | 16530.08 |
| 16 | 1997-2002 Wrangler, Axle Shaft [Rear Dana 44], LH Without ABS | 16530.09 |
| 16 | 1997-2002 Wrangler, Axle Shaft [Rear Dana 44], RH Without ABS | 16530.10 |
| 16 | 1994-1998 Grand Cherokee, Axle Shaft [Rear Dana 44], RH | 16530.12 |
| 16 | 1994-1998 Grand Cherokee, Axle Shaft [Rear Dana 44], LH | 16530.11 |
| 16 | 2003-2006 Wrangler, Axle Shaft [Rear Dana 44], LH With ABS & Rear Drums | 16523.47 |
| 16 | 2003-2006 Wrangler, Axle Shaft [Rear Dana 44], RH With ABS & Rear Drums | 16523.48 |
| 16 | 2003-2006 Wrangler, Axle Shaft [Rear Dana 44], LH With ABS & Rear Disc | 16530.15 |
| 16 | 2003-2006 Wrangler, Axle Shaft [Rear Dana 44], RH With ABS & Rear Disc | 16530.16 |
| 17 | 1972-1975 CJ, 1986 CJ7, 1987-2006 Wrangler, 1986-1993 Cherokee, Outer Axle Oil Seal [Rear Dana 44] | 16534.02 |
| 17 | 2007-2011 Wrangler, Outer Axle Oil Seal [Rear Dana 44] | 16534.14 |
| 18 | 1972-1975 CJ5, 1972-1975 CJ6, Inner Axle Oil Seal [Rear Dana 44] | 16535.02 |
| 18A | 1987-1995 Wrangler, Axle Shaft Retainer Plate [Rear Dana 44] | 16536.38 |

I. Rear Dana-44 with Flanged Axles (Cont.)

Part#

| | | |
|----|---|--------------|
| 19 | 1972-1975 CJ, 1986 CJ7, 1987-2011 Wrangler, 1986-1993 Cherokee, Axle Shaft Bearing & Cup with Retainer [Rear Dana 44] | 16536.05 |
| 21 | 1948-1969 CJ, 1972-1986 CJ, 1987-95 Wrangler, 1984-1991 Cherokee, Front Dana 30 Rear Dana 44 Axle, Dana 20/300 Transfer Case, Yoke 26 Spline [u-bolt style] | 16580.02 |
| 21 | 1987-2010 Wrangler, 1984-2001 Cherokee, 1993-1998 Grand Cherokee, 2002-2007 Liberty, Dana 30 Rear Dana 44 [97 Wrangler only], Strap & Bolt Style Yoke [26 Spline] | 16580.07 |
| 21 | 1998-2006 Wrangler, Rear Dana 44, Yoke [26 Spline] [Strap & Bolt Design] | 16580.15 |
| 22 | 1941-1969 CJ, 1972-1986 CJ, 1987-2010 Wrangler, 1984-2001 Cherokee, 1993-1998 Grand Cherokee, 2002-2007 Liberty, Dana 25/2730/44, AMC 20 Axle, Dana 20/300 & Quadratrac Transfer Case, U-bolt kit for Yoke part number 16580.02 Pair | 16582.01 |
| 22 | 1941-1969 CJ, 1972-1986 CJ, 1987-2010 Wrangler, 1984-2001 Cherokee, 1993-1998 Grand Cherokee, 2002-2007 Liberty, Dana 25/2730/44, AMC 20 Axle, Dana 20/300 & Quadratrac Transfer Case, U-bolt kit for Yoke part number 16580.02 Pair [Spicer Br&] | 16582.02 |
| 23 | 1981-1986 CJ, 1987-2010 Wrangler, 1981-2001 Cherokee, 1993-1998 Grand Cherokee, 2002-2007 Liberty, Front Dana 30, Rear Dana 35/44, AMC 20 Axle, Dana 300 Transfer Case, Yoke Strap & Bolt Kit | 16582.03 |
| 24 | 1972-1983 CJ5, 1972-1975 CJ6, 1986 CJ7, 1987-2011 Wrangler, 1993-1998 Grand Cherokee, Differential Cover Kit [Rear Dana 44], Includes: Cover, Gasket & Bolts | 16595.83 |
| 24 | 2002-2006 Wrangler, Differential Cover Kit [Rear Dana 44], With Air Locker, Includes: Cover, Gasket & Bolts | 16595.85 |
| 24 | 1972-1983 CJ5, 1972-1975 CJ6, 1986 CJ7, 1987-2011 Wrangler, 1993-1998 Grand Cherokee, Differential Cover [Rear Dana 44] | 16595.86 |
| 25 | 1972-1983 CJ5, 1972-1975 CJ6, 1986 CJ7, 1987-2011 Wrangler, 1993-1998 Grand Cherokee, Differential Cover Kit [Rear Dana 44], Heavy Duty, Cast Steel UPGRADE | 16595.44 |
| 26 | 1972-1983 CJ5, 1972-1975 CJ6, 1986 CJ7, 1987-2011 Wrangler, 1993-1998 Grand Cherokee, Differential Skid Plate [Rear Dana 44], Heavy Duty, Cast Steel UPGRADE | 16597.44 |
| 26 | 2002-2006 Wrangler, Differential Cover Drain Plug [Rear Dana 44], With Air Locker | DMC-16597.44 |
| 27 | 1987-1995 Wrangler, Differential Side Gear Set [Rear Dana 44] NEW | 16507.42 |

All images are subject to be representative. More detailed information is available online.

Axle - Rear Dana 35

Rear Dana 35:
 1987-2011 Wrangler,
 1984-2001 Cherokee,
 1993-2004 Grand
 Cherokee



**OFFICIAL
 LICENSED
 PRODUCT**

MOPAR, JEEP, DODGE, HEMI, PLYMOUTH, RAM, and CHRYSLER vehicles, images and logos are trademarks of Chrysler Group LLC used under license to Omix-Ada®. © Chrysler Group LLC 2011

Look for the star to check out all the Mopar Licensed Products

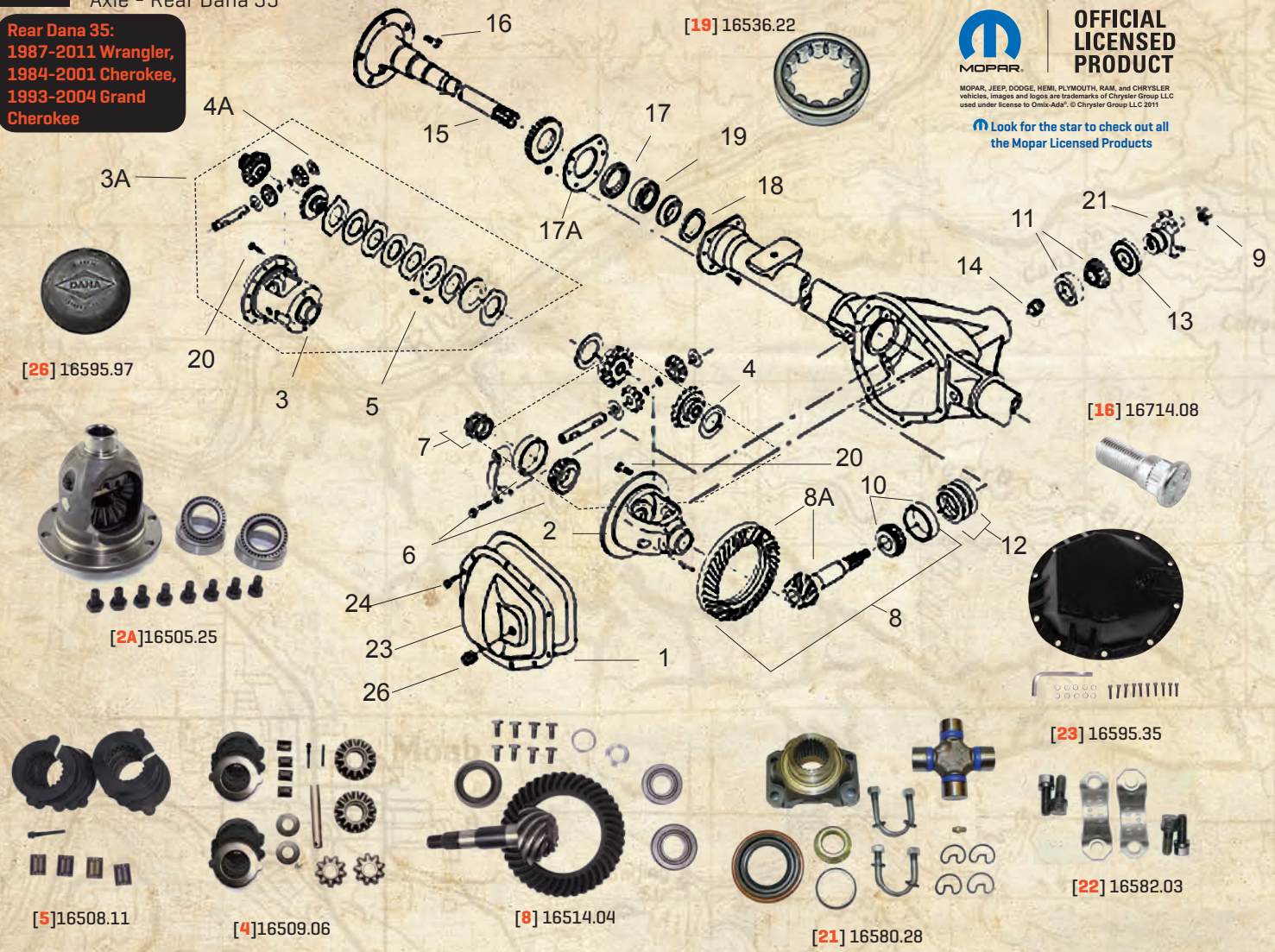

J. Rear Dana 35-1987-2011 Wrangler, 1984-2001 Cherokee, 1993-2004 Grand Cherokee

Part#

| | | |
|----|--|----------|
| 1 | RTV Silicon [3 oz] | 19201.01 |
| 1 | 1987-2011 Wrangler, 1984-2001 Cherokee, 1993-2004 Grand Cherokee, Dana 35, Differential Cover Gasket | 16502.04 |
| 1A | 1987-2011 Wrangler, 1984-2001 Cherokee, 1993-1999 Grand Cherokee, Dana 35, Rebuild Kit [Bearings, Seals, Shims, Hardware] | 16501.06 |
| 1A | 1999-2004 Grand Cherokee, Dana 35, Rebuild Kit [Bearings, Seals, Shims, Hardware] | 16501.09 |
| 2 | 1987-1993 Wrangler, Dana 35, Standard Differential Case 2.73-3.31 Ratio [Except 1993 BOM 605528] | 16503.40 |
| 2 | 1993-2001 Cherokee, 1993-1998 Grand Cherokee, Dana 35, Standard Differential Case 2.73-3.31 Ratio | 16503.41 |
| 2 | 1987-1989 Wrangler, Dana 35, Standard Differential Case 3.55-4.56 Ratio | 16503.42 |
| 2 | 1990-1993 Wrangler, Dana 35, Standard Differential Case 3.55-4.56 Ratio [Except 1993 with BOM 605528] | 16503.43 |
| 2 | 1993 Wrangler (with BOM 605528), 1994-2006 Wrangler, 1993-2001 Cherokee, 1993-1998 Grand Cherokee, Dana 35, Standard Differential Case 3.55-4.56 Ratio | 16503.44 |
| 2 | 2001-2002 Wrangler, Dana 35, Standard Differential Case 3.07 Ratio | 16503.66 |
| 2A | 1987-1995 Wrangler, 1984-2000 Cherokee, 1993-2004 Grand Cherokee, Dana 35, Standard Differential Kit 2.73-3.07 Ratio | 16505.23 |
| 2A | 2001-2002 Wrangler, 2001 Cherokee, Dana 35, Standard Differential Kit 3.07 Ratio | 16505.11 |
| 2A | 1987-1993 Wrangler, 1987-1993 Cherokee, Dana 35, Standard Differential Kit 3.31-4.56 Ratio | 16505.20 |
| 2A | 1992-1994 Cherokee, Dana 35, Standard Differential Kit 3.55-4.56 Ratio [Spicer] | 16505.21 |
| 2A | 1994-2006 Wrangler, 1994-2001 Cherokee, 1994-1998 Grand Cherokee, Dana 35, Standard Differential Kit 3.55-4.56 Ratio | 16505.24 |
| 2A | 1999-2004 Grand Cherokee, Dana 35, Standard Differential Kit 3.55-3.73 Ratio | 16505.25 |

J. Rear Dana 35-1987-2011 Wrangler, 1984-2001 Cherokee, 1993-2004 Grand Cherokee

Part#

| | | |
|----|--|----------|
| 2A | 2001-2002 Wrangler with 4.11/4.56 and without Trac Lok, 2001 Cherokee with 3.55 and Trac Lok, Dana 35, Standard Differential Kit | 16505.19 |
| 2A | 2001-2002 Wrangler, Dana 35, Standard Differential Kit 3.73 Ratio with Trac Lok | 16505.17 |
| 3 | 1997-2001 Wrangler and Cherokee, Dana 35, Trac-Loc Case Only 3.07 Ratio | 16503.60 |
| 3 | 1987-2000 Wrangler, Dana 35, Trac-Loc Case Only 3.55-4.56 Ratio [will not fit 1992-1993 Wrangler] | 16503.48 |
| 3 | 2001-2002 Wrangler with 3.73-4.56 Ratio, 2001 Cherokee with 4.55 Ratio, Dana 35, Trac-Loc Case Only | 16503.63 |
| 3A | 1987-2000 Wrangler, Dana 35, Trac-Loc Case Assembly with Gear Kit 2.73-3.31 ratio [will not fit 1992-1993 Wrangler] | 16505.29 |
| 3A | 1987-200 Wrangler, Dana 35, Trac-Loc Case Assembly with Gear Kit 3.55-4.56 ratio [will not fit 1992-1993 Wrangler] | 16505.30 |
| 3A | 1999-2004 Grand Cherokee, Dana 35, Trac-Loc Case Assembly Kit | 16505.31 |
| 3A | 2001-2002 Wrangler, 2001 Cherokee, Dana 35, Trac-Loc Case Assembly Kit 3.07 Ratio | 16503.51 |
| 4 | 1987-1993 Wrangler, Dana 35, Standard Differential Spider Gear Kit [Not for 1993 with BOM 605528] | 16507.30 |
| 4 | 1993 Wrangler with BOM 605528, Dana 35, Standard Differential Kit | 16507.31 |
| 4 | 1997-2002 Wrangler, Dana 35, Trac-Loc Differential Disc Kit | 16509.06 |
| 4A | 1999-2003 Wrangler, Dana 35, Differential Pinion Thrust Washer | 16584.06 |
| 5 | 1987-2006 Wrangler, Dana 35, Trac-Loc Differential Spider Gear Kit with Disc Kit | 16507.32 |
| 5 | 1990-2002 Wrangler, Dana 35, Trac-Loc Differential Disc Kit | 16508.11 |
| 6 | 1987-2011 Wrangler, 1984-2001 Cherokee, 1993-2004 Grand Cherokee, Dana 35, Differential Case Bearing and Cup Kit [2 Bearings and 2 Cups] | 16509.05 |
| 7 | 1987-2011 Wrangler, 1984-2001 Cherokee, 1993-2004 Grand Cherokee, Dana 35, Differential Side Shim Kit | 16511.10 |
| 8 | 1987-2006 Wrangler, 1987-2001 Cherokee, Dana 35, Ring and Pinion Kit 3.07 Ratio [43x14 Teeth] [Bearings, Cups, Shims, Seals, Hardware] | 16514.01 |

Axle



| J. Rear Dana 35-1987-2011 Wrangler, 1984-2001 Cherokee, 1993-2004 Grand Cherokee | | Part# |
|--|---|----------|
| 8 | 1987-1993 Wrangler, Ring and Pinion Kit 3.55 Ratio (39x11 Teeth) [Bearings, Cups, Shims, Seals, Hardware] | 16514.02 |
| 8 | 1994-2006 Wrangler, 1994-2001 Cherokee, 1994-1998 Grand Cherokee, Ring and Pinion Kit 3.55 Ratio (39x11 Teeth) [Bearings, Cups, Shims, Seals, Hardware] | 16514.03 |
| 8 | 1994-2006 Wrangler, 1994-2001 Cherokee, 1994-1998 Grand Cherokee, Ring and Pinion Kit 3.73 Ratio [Bearings, Cups, Shims, Seals, Hardware] | 16514.04 |
| 8 | 1997-2001 Wrangler, Ring and Pinion Kit 4.11 Ratio (37x9 Teeth) [Bearings, Cups, Shims, Seals, Hardware] | 16514.05 |
| 8 | 1990-2001 Wrangler, Ring and Pinion Kit 4.56 Ratio (41x9 Teeth) [Bearings, Cups, Shims, Seals, Hardware] | 16514.06 |
| 8 | 2002 Wrangler, Ring and Pinion Kit 4.56 Ratio (41x9 Teeth) [Bearings, Cups, Shims, Seals, Hardware] | 16514.37 |
| 8A | 2001-2002 Wrangler, 2001 Cherokee, Dana 35, Ring and Pinion Kit 3.07 Ratio | 16514.52 |
| 8A | 1999-2004 Grand Cherokee, Dana 35, Ring and Pinion Set 3.55 Ratio | 16514.08 |
| 8A | 2001 Cherokee Standard, 1999-2004 Grand Cherokee with Trac-Loc, Dana 35, Ring and Pinion Set 3.55 Ratio | 16514.46 |
| 8A | 1999-2003 Grand Cherokee with Trac-Loc, Dana 35, Ring and Pinion Only 3.73 Ratio | 16514.48 |
| 8A | 1999-2004 Grand Cherokee, Dana 35, Ring and Pinion Set 3.73 Ratio | 16514.09 |
| 8A | 2001-2002 Wrangler, 2001 Cherokee DIESEL, Dana 35, Ring and Pinion Set 3.73 Ratio | 16514.49 |
| 8A | 2001-2002 Wrangler, Dana 35, Ring and Pinion Set 4.11 Ratio | 16514.54 |
| 8A | 1990-2002 Wrangler, Dana 35, Ring and Pinion Set 4.88 Ratio | 16514.07 |
| 9 | 1976-1986 CJ, 1987-2011 Wrangler, 1984-2001 Cherokee, 1993-2004 Grand Cherokee, Dana 35/Rear AMC-20, Pinion Nut | 16584.03 |
| 10 | 1987-2011 Wrangler, 1984-2001 Cherokee, 1993-2004 Grand Cherokee, Dana 35, Inner Pinion Bearing and Cup Kit | 16515.15 |
| 11 | 1997-2010 Wrangler, 1992-2001 Cherokee, 1993-2004 Grand Cherokee 2002-2007 Liberty, Dana 30/Super 30 Rear Dana 35, Outer Pinion Bearing [1 Bearing and 1 Cup] | 16517.02 |
| 11 | 1999-2002 Wrangler, Dana 35, Pinion Thrust Washer | 16584.07 |
| 12 | 1987-2006 Wrangler, 1984-2001 Cherokee, 1993-2004 Grand Cherokee, Dana 35, Pinion Shim Set | 16519.10 |
| 12 | 2003-2011 Wrangler, 1999-2004 Grand Cherokee Dana 35/44, Pinion Shim Kit [0.035-0.039] | 16519.02 |
| 12 | 2003-2011 Wrangler, 1999-2004 Grand Cherokee Dana 35/44, Pinion Shim Kit [0.040-0.044] | 16519.03 |
| 12 | 2003-2011 Wrangler, 1999-2004 Grand Cherokee Dana 35/44, Pinion Shim Kit [0.045-0.049] | 16519.04 |
| 12 | 2003-2011 Wrangler, 1999-2004 Grand Cherokee Dana 35/44, Pinion Shim Kit [0.050-0.054] | 16519.05 |
| 13 | 1987-2006 Wrangler, Dana 35, Inner Pinion Oil Seal | 16521.10 |
| 13 | 1999-2001 Cherokee, 199-2003 Grand Cherokee, Dana 35, Inner Pinion Oil Seal | 16521.16 |
| 13 | 1999-2001 Cherokee, 199-2003 Grand Cherokee, Dana 35, Outer Pinion Oil Seal | 16521.13 |
| 14 | 1987-1995 Wrangler, 1984-2001 Cherokee, 1993-1998 Grand Cherokee, 2003-2004 Grand Cherokee with 3.55 Ratio, Dana 35, Collapsible Pinion Spacer | 16512.59 |
| 14 | 2007-2011 Wrangler, Rear Dana 35/44, Collapsible Pinion Spacer | 16512.67 |
| 14 | 1999-2002 Grand Cherokee with 3.55 Ratio, 1999-2004 Grand Cherokee, Dana 35, Collapsible Pinion Spacer | 16512.64 |
| 15 | 1984-1989 Cherokee, 1987-1989 Wrangler, Dana 35, Driver Side Axle Shaft | 16530.51 |
| 15 | 1984-1989 Cherokee, 1987-1989 Wrangler, Dana 35, Passenger Side Axle Shaft | 16530.50 |
| 15 | 1990-2002 Wrangler, 1990-2001 Cherokee, Dana 35, Passenger Side Axle Shaft without ABS [C-clip Style] | 16530.52 |
| 15 | 1990-2002 Wrangler, 1990-2001 Cherokee, Dana 35, Driver Side Axle Shaft without ABS [C-clip Style] | 16530.53 |
| 15 | 1990-1991 Wrangler and Cherokee, Dana 35, Passenger Side Axle Shaft with ABS | 16530.54 |
| 15 | 1990-1991 Wrangler and Cherokee, Dana 35, Driver Side Axle Shaft with ABS | 16530.55 |
| 15 | 1992-2002 Wrangler, 1992-2001 Cherokee, 1993-1998 Grand Cherokee, Dana 35, Passenger Side Axle Shaft with ABS and DRUM Brakes | 16530.56 |

| J. Rear Dana 35-1987-2011 Wrangler, 1984-2001 Cherokee, 1993-2004 Grand Cherokee [Cont.] | | Part# |
|--|--|--------------|
| 15 | 1992-2002 Wrangler, 1992-2001 Cherokee, 1993-1998 Grand Cherokee, Dana 35, Driver Side Axle Shaft with ABS and DRUM Brakes | 16530.57 |
| 15 | 1994-1998 Grand Cherokee, Dana 35, Passenger Side Axle Shaft with ABS and Rear DISC Brakes | 16530.58 |
| 15 | 1994-1998 Grand Cherokee, Dana 35, Driver Side Axle Shaft with ABS and Rear DISC Brakes | 16530.59 |
| 15 | 1999-2004 Grand Cherokee, Dana 35, Passenger Side Axle Shaft | 16530.60 |
| 15 | 1999-2004 Grand Cherokee, Dana 35, Driver Side Axle Shaft | 16530.61 |
| 15 | 2003-2006 Wrangler, Dana 35, Passenger Side Axle with ABS and DRUM Brakes NEW | 16530.62 |
| 15 | 2003-2006 Wrangler, Dana 35, Driver Side Axle with ABS and DRUM Brakes NEW | 16530.63 |
| 15 | 2003-2006 Wrangler, Dana 35, Passenger Side Axle with ABS and DISK Brakes NEW | 16530.64 |
| 15 | 2003-2006 Wrangler, Dana 35, Driver Side Axle with ABS and DISK Brakes NEW | 16530.65 |
| 16 | 1991-2000 Wrangler, Dana 35, C-Clip | 16533.20 |
| 16 | 1987-2006 Wrangler, 1984-2001 Cherokee, Rear Drum Brakes, Wheel Stud | 16714.08 |
| 16 | 1987-2006 Wrangler, 1984-2001 Cherokee, Disc Brakes, Wheel Stud | 16714.09 |
| 17 | 1987-1989 Wrangler, 1984-1986 Cherokee, Dana 35, Outer Axle Oil Seal | 16534.10 |
| 17 | 1990-2000 Wrangler, 1990-2000 Cherokee, 1993-2000 Grand Cherokee, Dana 35, Outer Axle Oil Seal [each] | 16534.11 |
| 17 | 2007-2011 Wrangler, Dana 35, Outer Axle Oil Seal [each] | 16534.14 |
| 17A | 1987-1989 Wrangler, 1984-1989 Cherokee, Dana 35, Retainer | 16536.20 |
| 18 | 1993-2004 Grand Cherokee, Dana 35, Retainer | 16536.39 |
| 18 | 1987-1989 Wrangler, 1984-1989 Cherokee, Dana 35, Inner Axle Oil Seal | 16535.10 |
| 19 | 1987-1989 Wrangler, 1984-1989 Cherokee, Dana 35, Bearing Cup and Retainer [each Side] | 16536.21 |
| 19 | 1990-2006 Wrangler, 1990-2001 Cherokee, 1993-2004 Grand Cherokee, Dana 35, Wheel Bearing [each side] | 16536.22 |
| 20 | 1948-69 CJ, 1972-1986 CJ, 1984-2001 XJ Cherokee, 1993-2004 Grand Cherokee, 2002-2007 Liberty, 1987-2010 Wrangler Rear Dana 44 with Flanged Axle, Front Dana 30 Rear Dana 35/44 Ring gear bolt | 16522.01 |
| 20 | 1948-69 CJ, 1972-1986 CJ, 1984-2001 XJ Cherokee, 1993-2004 Grand Cherokee, 2002-2007 Liberty, 1987-2010 Wrangler Rear Dana 44 with Flanged Axle, Front Dana 30 Rear Dana 35/44 Ring Gear Bolt Set | 16521.81 |
| 20 | 1972-1986 CJ, 1987-2010 Wrangler, 1984-01 Cherokee, 1993-2004 Grand Cherokee, Dana 30/35/44 AMC 20 | 16522.02 |
| 21 | 1987-1993 Wrangler, 1997 Wrangler, Dana 35, Yoke [Strap and Bolt Design] | 16580.20 |
| 21 | 1994-1995 Wrangler, Dana 35, Yoke [use with 3 5/8 inch U-Joints] | 16580.21 |
| 21 | 1997-2006 Wrangler, Dana 35, Yoke [use with 3 7/32 inch U-Joints] | 16580.22 |
| 21 | 1987-1993 Wrangler, 1997-2002 Wrangler, Dana 35, U-Bolt Design Yoke Kit | 16580.23 |
| 21 | 2001 Cherokee with ABS, Dana 35, Yoke | 16580.62 |
| 21 | 1987-1993 Wrangler, 1997-2002 Wrangler, 1984-1995 Cherokee, Dana 35, Yoke Kit | 16580.28 |
| 22 | 1981-1986 CJ, 1987-2010 Wrangler, 1981-2001 Cherokee, 1993-1998 Grand Cherokee, 2002-2007 Liberty, Front Dana 30, Rear Dana 35/44, AMC 20 Axle, Dana 300 Transfer Case, U-Bolt Kit for Yoke 16580.03 | 16582.03 |
| 22 | 1990-2006 Wrangler, 1990-2001 Cherokee, 1993-2004 Grand Cherokee, Dana 35, Cross Shaft Locking Bolt | 16507.33 |
| 23 | 1987-2011 Wrangler, 1984-2001 Cherokee, 1993-2004 Grand Cherokee, Dana 35, Heavy Duty 3/8 inch Thick Cast Steel Differential Cover [with Hardware] | 16595.35 |
| 24 | 1972-1986 CJ, 1987-2010 Wrangler, 1987-01 Cherokee, 1993-2004 Grand Cherokee, Dana 30/35/44 AMC 20, Differential Bolt Cover | 16522.02 |
| 25 | 1987-2011 Wrangler, 1984-2001 Cherokee, 1993-2004 Grand Cherokee, Dana 35, Heavy Duty 3/8 inch Thick Cast Steel Differential Skid Plate [with Hardware] | 16597.35 |
| 25 | Heavy Duty Differential Cover For Dana 35 | DMC-16595.35 |
| 26 | 1987-2011 Wrangler, 1984-2001 Cherokee, 1993-2004 Grand Cherokee, Dana 35, Differential Cover Plug | 16595.97 |

All images are subject to be representative. More detailed information is available online.



AMC 20:
Narrow Track: 1976-1983 CJ5, 1976-1981 CJ7, 1981 CJ8
Quadratrac: 1976-1979 CJ7
Wide Track: 1982-1986 CJ7 1982-1986 CJ8



[K] 16530.22



[K] 16535.03

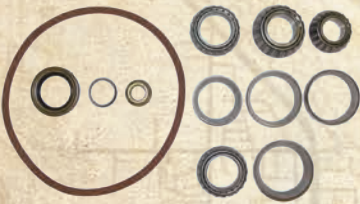

[K1] 16501.05

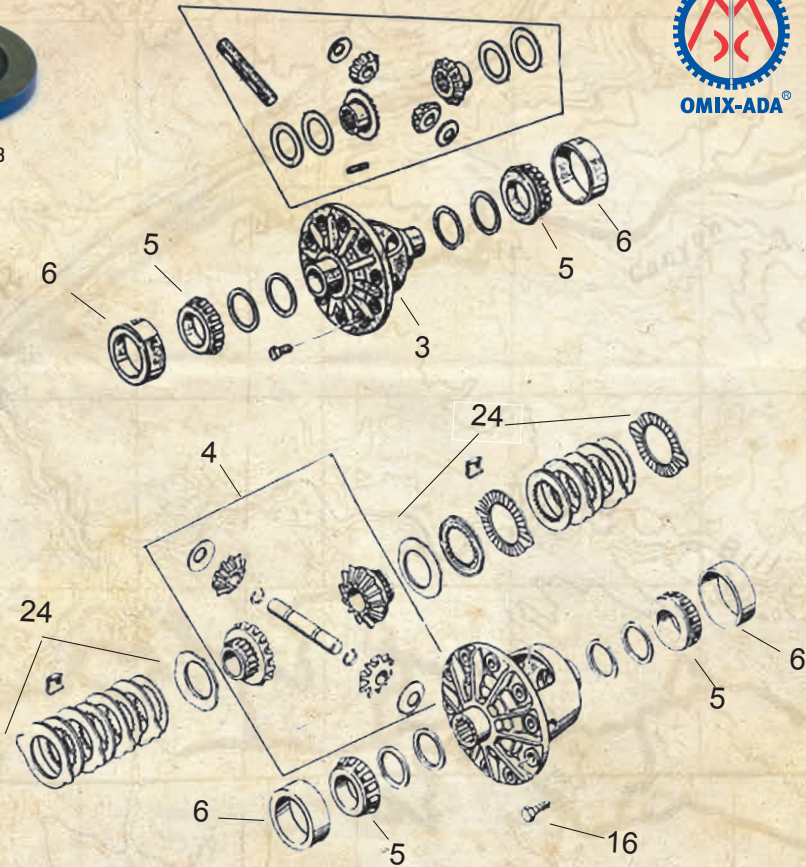

K. Rear AMC Model-20 (1 Pc Axles)

Part#

| | |
|--|----------|
| 1976-1983 CJ5, 1976-1981 CJ7, 1981 CJ8, One Piece Axle Conversion Kit [AMC 20 Narrow Track], Includes: Axles, Bearings, Retainers, Spacers, Inner and Outer Seals, Studs | 16530.20 |
| 1982-1986 CJ7, 1982-1986 CJ8, One Piece Axle Conversion Kit [AMC 20 Wide Track], Includes: Axles, Bearings, Retainers, Spacers, Inner and Outer Seals, Studs | 16530.21 |
| 1976-1979 CJ7, One Piece Axle Conversion Kit [AMC 20 Quadratrac], Includes: Axles, Bearings, Retainers, Spacers, Inner and Outer Seals, Studs | 16530.22 |
| 1976-1983 CJ5, 1976-1981 CJ7, 1981 CJ8, One Piece Axle Kit [AMC 20 Narrow Track], Left, Includes: LH Axle, Bearings, Retainers, Spacers, Inner and Outer Seals, Studs | 16530.37 |
| 1976-1983 CJ5, 1976-1981 CJ7, 1981 CJ8, One Piece Axle Kit [AMC 20 Narrow Track], Right, Includes: RH Axle, Bearings, Retainers, Spacers, Inner and Outer Seals, Studs | 16530.38 |
| 1976-1979 CJ7, One Piece Axle Kit [AMC 20 Quadratrac], Left, Includes: LH Axle, Bearings, Retainers, Spacers, Inner and Outer Seals, Studs | 16530.39 |
| 1976-1979 CJ7, One Piece Axle Kit [AMC 20 Quadratrac], Right, Includes: RH Axle, Bearings, Retainers, Spacers, Inner and Outer Seals, Studs | 16530.40 |
| 1976-1983 CJ5, 1976-1986 CJ7, 1981-1986 CJ8, Once Piece Axle Conversion Bearing & Hardware Kit [AMC 20], Does Both Sides | 16536.06 |
| 1976-1983 CJ5, 1976-1986 CJ7, 1981-1986 CJ8, Once Piece Axle Conversion Bearing & Hardware Kit [AMC 20], Does One Side, LH or RH | 16536.07 |
| 1976-1983 CJ5, 1976-1986 CJ7, 1981-1986 CJ8, Once Piece Axle Conversion Axle Bearing [AMC 20], LH or RH | 16536.08 |
| 1976-1983 CJ5, 1976-1986 CJ7, 1981-1986 CJ8, Once Piece Axle Conversion Axle Bearing Retainer [AMC 20], LH or RH | 16536.09 |
| 1976-1986 CJ, AMC-20, Once Piece Axle Conversion Axle Bearing Spacer [AMC 20], LH or RH | 16536.10 |
| 1976-1983 CJ5, 1976-1986 CJ7, 1981-1986 CJ8, Once Piece Axle Conversion Inner Axle Oil Seal [AMC 20] LH or RH | 16535.03 |
| 1976-1986 CJ, AMC-20, Once Piece Axle Conversion Spare Outer Axle Oil Seal [AMC 20], Each | 16534.03 |
| 1976-1983 CJ5, 1976-1986 CJ7, 1981-1986 CJ8, Once Piece Axle Conversion Sealed Wheel Bearing Kit [AMC 20] | 16560.59 |
| 1976-1983 CJ5, 1976-1981 CJ7, 1981 CJ8, Axle Shaft [AMC 20 Narrow Track], LH [26.25"] | 16530.25 |

K. Rear AMC Model-20

Part#

| | |
|--|----------|
| 1 1976-1983 CJ5, 1976-1986 CJ7, 1981-1986 CJ8, Differential Rebuild Kit [AMC 20], Includes: Bearings, Seals & Hardware | 16501.05 |
| 2 1976-1983 CJ5, 1976-1986 CJ7, 1981-1986 CJ8, Differential Cover Gasket [AMC 20] | 16502.03 |
| 3 1976-1983 CJ5, 1976-1986 CJ7, 1981-1986 CJ8, Standard Differential Case [AMC 20], [Except 2.73 Ratio] | 16503.31 |
| 4 1976-1983 CJ5, 1976-1986 CJ7, 1981-1986 CJ8, Spider Gear Kit With Trac-Loc [AMC 20] | 16507.23 |
| 5 1976-1983 CJ5, 1976-1986 CJ7, 1981-1986 CJ8, Differential Side Bearing [AMC 20], [2 Required] | 16509.25 |
| 6 1976-1983 CJ5, 1976-1986 CJ7, 1981-1986 CJ8, Differential Side Cup [AMC 20] [2 Required] | 16509.26 |
| 8 1976-1983 CJ5, 1976-1986 CJ7, 1981-1986 CJ8, Ring & Pinion [AMC 20], 3.31 Ratio [43x13 Teeth] | 16513.81 |
| 8 1976-1983 CJ5, 1976-1986 CJ7, 1981-1986 CJ8, Ring & Pinion [AMC 20], 3.54 Ratio [39x11 Teeth] | 16513.82 |
| 8 1976-1983 CJ5, 1976-1986 CJ7, 1981-1986 CJ8, Ring & Pinion [AMC 20], 3.73 Ratio [41x11 Teeth] | 16513.83 |
| 8 1976-1983 CJ5, 1976-1986 CJ7, 1981-1986 CJ8, Ring & Pinion [AMC 20], 4.10 Ratio [41x10 Teeth] | 16513.84 |
| 8 1976-1983 CJ5, 1976-1986 CJ7, 1981-1986 CJ8, Ring & Pinion [AMC 20], 4.56 Ratio [41x9 Teeth] | 16513.85 |
| 8 1976-1983 CJ5, 1976-1986 CJ7, 1981-1986 CJ8, Ring & Pinion [AMC 20], 4.88 Ratio | 16513.86 |
| 9 1976-1983 CJ5, 1976-1986 CJ7, 1981-1986 CJ8, Pinion Nut [AMC 20] | 16584.03 |
| 10 1976-1983 CJ5, 1976-1986 CJ7, 1981-1986 CJ8, Inner Pinion Bearing [AMC 20] | 16515.20 |
| 11 1976-1983 CJ5, 1976-1986 CJ7, 1981-1986 CJ8, Inner Pinion Cup [AMC 20] | 16515.21 |
| 12 1976-1983 CJ5, 1976-1986 CJ7, 1981-1986 CJ8, Outer Pinion Bearing [AMC 20] | 16517.20 |
| 13 1976-1983 CJ5, 1976-1986 CJ7, 1981-1986 CJ8, Outer Pinion Cup [AMC 20] | 16517.21 |
| 14A 1976-1983 CJ5, 1976-1986 CJ7, 1981-1986 CJ8, Collapsible Pinion Spacer [AMC 20] | 16512.60 |
| 15 1976-1983 CJ5, 1976-1986 CJ7, 1981-1986 CJ8, Pinion Oil Seal [AMC 20] | 16521.07 |
| 17 1976-1983 CJ5, 1976-1986 CJ7, 1981-1986 CJ8, Axle Shaft Bearing & Cup [AMC 20], With Retainer | 16536.15 |
| 18 1976-1983 CJ5, 1976-1986 CJ7, 1981-1986 CJ8, Wheel Stud [AMC 20], Right Hand Thread, Each | 16714.06 |

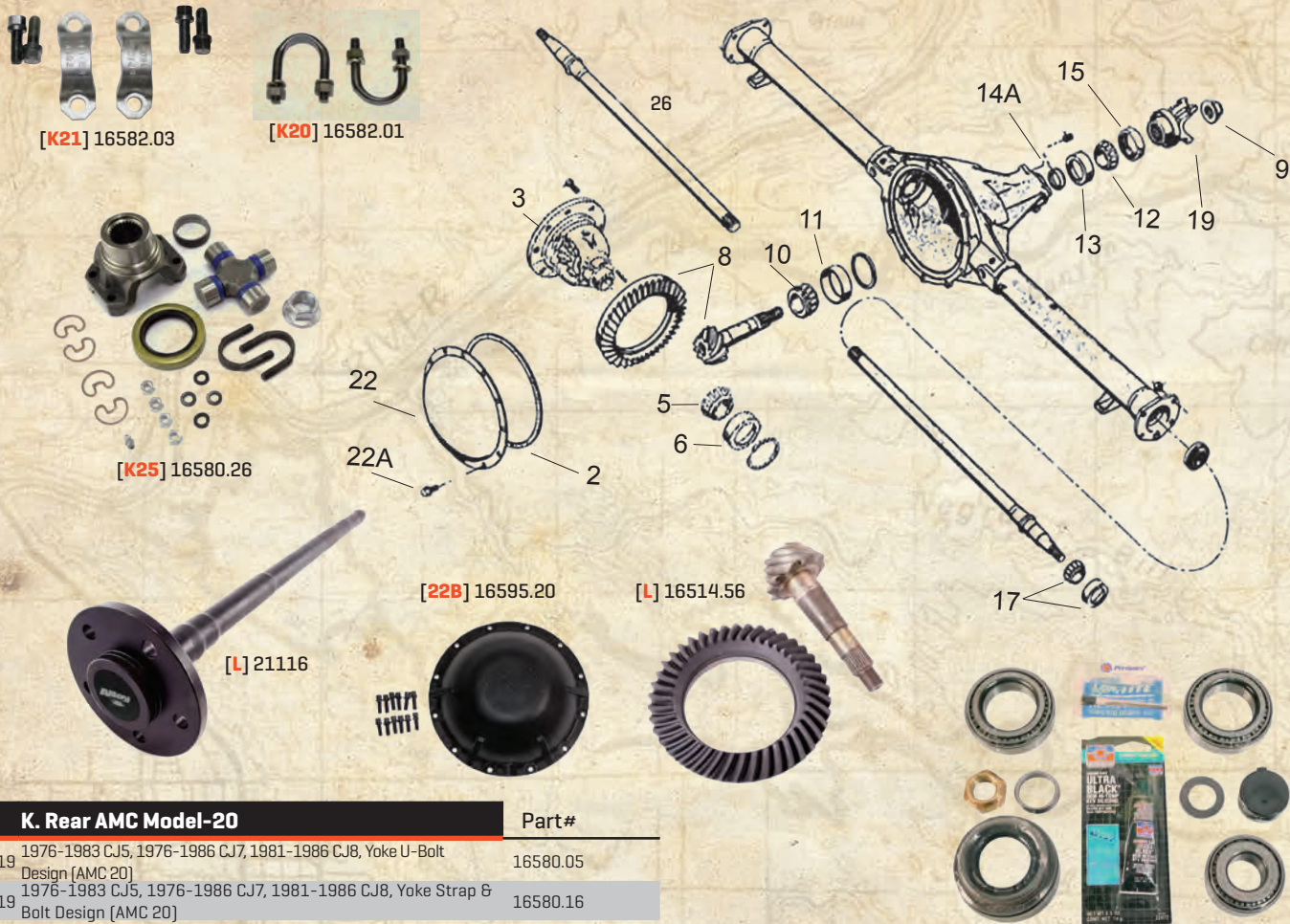

| K. Rear AMC Model-20 | | Part# |
|----------------------|---|----------|
| 19 | 1976-1983 CJ5, 1976-1986 CJ7, 1981-1986 CJ8, Yoke U-Bolt Design [AMC 20] | 16580.05 |
| 19 | 1976-1983 CJ5, 1976-1986 CJ7, 1981-1986 CJ8, Yoke Strap & Bolt Design [AMC 20] | 16580.16 |
| 20 | 1976-1983 CJ5, 1976-1986 CJ7, 1981-1986 CJ8, Yoke U-Bolt [AMC 20], Pair | 16582.01 |
| 21 | 1976-1983 CJ5, 1976-1986 CJ7, 1981-1986 CJ8, Yoke U-Bolt [AMC 20], Pair, Dana Spicer Brand | 16582.02 |
| 21 | 1976-1983 CJ5, 1976-1986 CJ7, 1981-1986 CJ8, Yoke Strap & Bolt Kit [AMC 20] | 16582.03 |
| 22 | 1976-1983 CJ5, 1976-1986 CJ7, 1981-1986 CJ8, Differential Cover Kit [AMC 20], Stainless Steel | 11118.04 |
| 22B | 1976-1983 CJ5, 1976-1986 CJ7, 1981-1986 CJ8, Heavy Duty Differential Cover 3/8" Thick Cast Steel with Hardware | 16595.20 |
| 22A | 1976-1983 CJ5, 1976-1986 CJ7, 1981-1986 CJ8, Differential Cover Bolt [AMC 20] | 16522.02 |
| 23 | 1976-1986 CJ, Rear AMC-20, Axle Housing Spring Pad [AMC 20], Pair | 16527.40 |
| 24 | 1976-1983 CJ5, 1976-1986 CJ7, 1981-1986 CJ8, Trac-Loc Disk Kit [AMC 20] | 16508.05 |
| 25 | 1976-1983 CJ5, 1976-1986 CJ7, 1981-1986 CJ8, Yoke Kit U-Bolt Design [AMC 20], Includes: Yoke & Spicer U-Joints | 16580.26 |
| 26 | 1976-1983 CJ5, 1976-1981 CJ7, 1981 CJ8, Axle Shaft Kit [AMC 20 Narrow Track], LH [26.25"], Includes: Axle, Hub, Bearing, Cup, Inner Seal Outer Seal, Nut, Washer, & Key | 16530.27 |
| 26 | 1976-1983 CJ5, 1976-1981 CJ7, 1981 CJ8, Axle Shaft [AMC 20 Narrow Track], LH [26.25"] | 16530.25 |
| 26 | 1976-1983 CJ5, 1976-1981 CJ7, 1981 CJ8, Axle Shaft [AMC 20 Narrow Track], RH [29.25"] | 16530.26 |
| 26 | 1976-1983 CJ5, 1976-1981 CJ7, 1981 CJ8, Axle Shaft Kit [AMC 20 Narrow Track], RH [29.25"], Includes: Axle, Hub, Bearing, Cup, Inner and Outer Seal, Nut, Washer & Key | 16530.28 |
| 26 | 1982-1986 CJ7, 1982-1986 CJ8, Axle Shaft [AMC 20 Wide Track], LH [28.5"] | 16530.29 |
| 26 | 1982-1986 CJ7, 1982-1986 CJ8, Axle Shaft [AMC 20 Wide Track], LH [28.5"], Includes: Axle, Hub, Bearing, Cup, Inner and Outer Seal, Nut, Washer & Key | 16530.31 |
| 26 | 1982-1986 CJ7, 1982-1986 CJ8, Axle Shaft [AMC 20 Wide Track], RH [31.5"] | 16530.30 |
| 26 | 1982-1986 CJ7, 1982-1986 CJ8, Axle Shaft [AMC 20 Wide Track], RH [31.5"], Includes: Axle, Hub, Bearing, Cup, Inner and Outer Seal, Nut, Washer & Key | 16530.32 |
| 26 | 1976-1979 CJ7, Axle Shaft [AMC 20 Quadratrak], LH [33.5"] | 16530.33 |
| 26 | 1976-1979 CJ7, Axle Shaft [AMC 20 Quadratrak], LH [33.5"], Includes: Axle, Hub, Bearing, Cup, Inner and Outer Seal, Nut, Washer & Key | 16530.35 |
| 26 | 1976-1979 CJ7, Axle Shaft [AMC 20 Quadratrak], RH [22"] | 16530.34 |
| 26 | 1976-1979 CJ7, Axle Shaft [AMC 20 Quadratrak], RH [22"], Includes: Axle, Hub, Bearing, Cup, Inner and Outer Seal, Nut, Washer & Key | 16530.36 |

| K. Rear AMC Model-20 | | Part# |
|----------------------|--|----------|
| 19 | 1976-1983 CJ5, 1976-1986 CJ7, 1981-1986 CJ8, Hub with Studs [AMC 20] | 16537.02 |
| 19 | 1976-1983 CJ5, 1976-1986 CJ7, 1981-1986 CJ8, Hub Kit [AMC 20], Includes: Hub, Bearing, Cup, Oil Seals, Nut, Washer & Key | 16537.03 |
| 19 | 1976-1986 CJ, Axle Bearing & Cup [AMC 20] | 16536.15 |
| 19 | 1976-1983 CJ5, 1976-1986 CJ7, 1981-1986 CJ8, Inner Axle Oil Seal [AMC 20] | 16535.03 |
| 19 | 1976-1983 CJ5, 1976-1986 CJ7, 1981-1986 CJ8, Outer Axle Oil Seal [AMC 20] | 16534.03 |
| 19 | 1976-1983 CJ5, 1976-1986 CJ7, 1981-1986 CJ8, Axle Nut, Washer, Key Kit [AMC 20], LH or RH | 16533.04 |
| 19 | 1976-1983 CJ5, 1976-1986 CJ7, 1981-1986 CJ8, Rear Axle Shim [AMC 20], [0.0003"] | 16533.05 |
| 19 | 1976-1983 CJ5, 1976-1986 CJ7, 1981-1986 CJ8, Rear Axle Shim [AMC 20], [0.0010"] | 16533.06 |
| 19 | 1976-1983 CJ5, 1976-1986 CJ7, 1981-1986 CJ8, Rear Axle Shim Kit [AMC 20], Includes: 1-0.0003", 1-0.0010" | 16533.07 |
| 19 | 1976-1983 CJ5, 1976-1986 CJ7, 1981-1986 CJ8, Outer Axle Dust Shield [AMC 20] | 16533.08 |
| 19 | 1976-1983 CJ5, 1976-1986 CJ7, 1981-1986 CJ8, Axle Hub Dust Cap [AMC 20], Metal | 16533.09 |
| 19 | 1976-1983 CJ5, 1976-1986 CJ7, 1981-1986 CJ8, Axle Hub Dust Cap [AMC 20], Plastic | 16533.10 |

| L. Miscellaneous Axle | | Part# |
|-----------------------|---|----------|
| 19 | 1968-1970 Jeep Pickup with Dana 44, J100, J2500, J2600 J3500 / Dana 60, Outer Axle Seal | 16534.35 |
| 19 | 1991-2001 Cherokee, Axle Bearing Kit [Chrysler 8.25"] | 16501.07 |
| 19 | 1991-2001 Cherokee, Axle Rebuild Kit [Chrysler 8.25"] | 16501.08 |
| 19 | 1991-2001 Cherokee, Ring & Pinion, 3.55 Ratio [Chrysler 8.25"] | 16514.56 |
| 19 | 1991-2001 Cherokee, Ring & Pinion, 4.10 Ratio [Chrysler 8.25"] | 16514.57 |
| 19 | 1991-1996 Cherokee, Axle Shaft [Chrysler 8.25"], Rear LH or RH [27 Spline] Upgrade | 21116 |
| 19 | 1997-2001 Cherokee, Axle Shaft [Chrysler 8.25"], Rear LH or RH [29 Spline] Upgrade | 21118 |

All images are subject to be representative. More detailed information is available online.

Axle - Rear Dana 44

Rear Dana 44:
1999-2010 Grand Cherokee

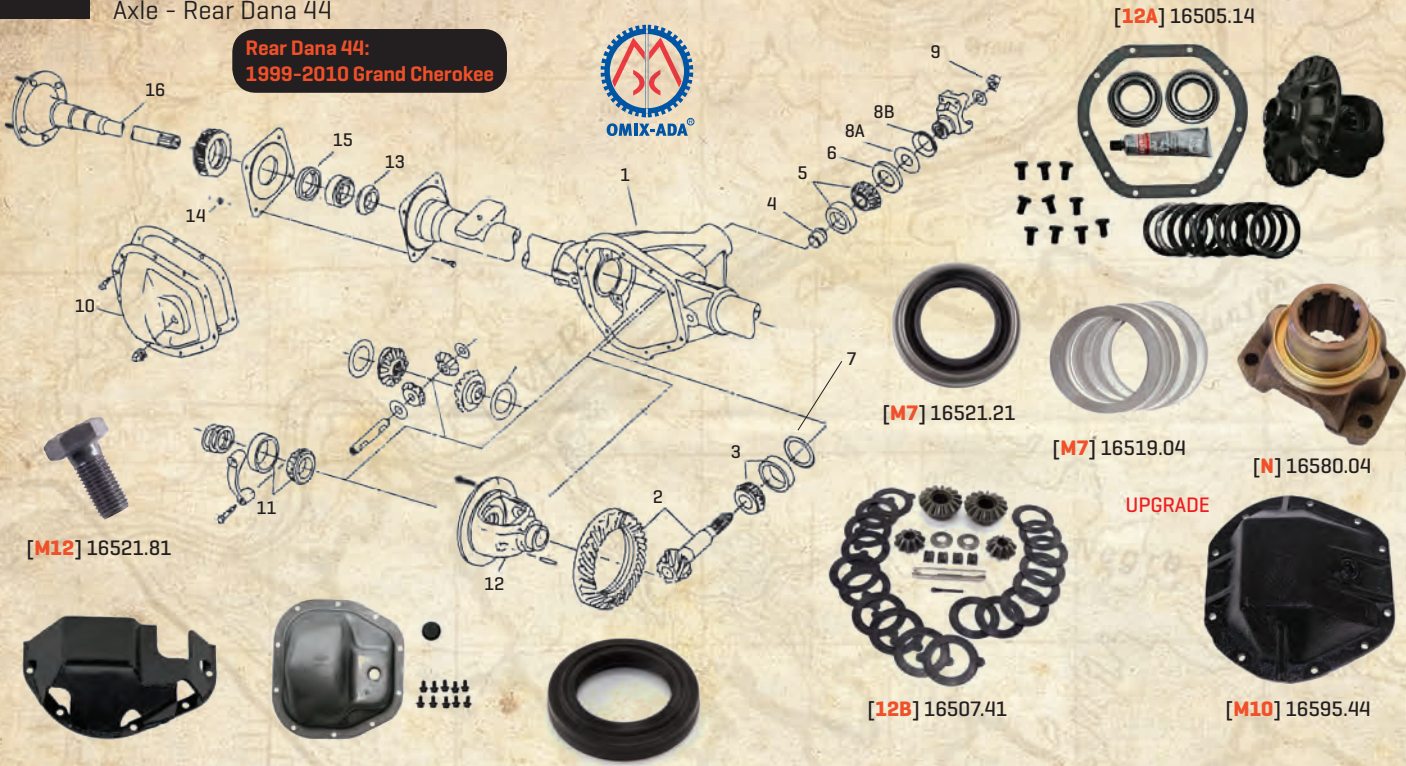

M. 1999-2010 Grand Cherokee Rear Dana-44

| Part# | Description | Part# |
|-------|---|----------|
| 1 | 1999-2000 Grand Cherokee, Rear Dana 44, Differential Rebuild Kit with 3/8 inch Ring Gear Bolts | 16501.10 |
| 1 | 1999-2004 Grand Cherokee, Rear Dana 44, Differential Rebuild Kit with 7/16 inch Ring Gear Bolts | 16501.11 |
| 2 | 1996-1998 Grand Cherokee, Rear Dana 44, Ring and Pinion Only 3.55 Ratio | 16514.20 |
| 2 | 1996-1998 Grand Cherokee, Rear Dana 44, Ring and Pinion Only 3.73 Ratio | 16514.21 |
| 2 | 1999-2004 Grand Cherokee, Rear Dana 44, Ring and Pinion Only 3.37 Ratio with 3/8 inch Ring Gear Bolts | 16514.25 |
| 2 | 1999-2004 Grand Cherokee, Rear Dana 44, Ring and Pinion Only 3.91 Ratio with 3/8 inch Ring Gear Bolts | 16514.26 |
| 2A | 1999-3/29/2000 Grand Cherokee, Rear Dana 44, Ring and Pinion Kit 3.73 Ratio with 3/8 inch Ring Gear Bolts | 16514.33 |
| 2A | 1999-2004 Grand Cherokee, Rear Dana 44, Ring and Pinion Kit 3.55 Ratio with 7/16 inch Ring Gear Bolts | 16514.34 |
| 2A | 1999-2004 Grand Cherokee, Rear Dana 44, Ring and Pinion Kit 3.91 Ratio with 7/16 inch Ring Gear Bolts | 16514.35 |
| 2A | 3/30/2000-2004 Grand Cherokee, Rear Dana 44, Ring and Pinion Kit 3.73 Ratio with 7/16 inch Ring Gear Bolts | 16514.40 |
| 3 | 1996-2004 Grand Cherokee, Rear Dana 44, Inner Pinion Bearing | 16515.26 |
| 4 | 1996-2004 Grand Cherokee, Rear Dana 44, Collapsible Spacer | 16512.62 |
| 5 | 1996-2004 Grand Cherokee, Rear Dana 44, Outer Pinion Bearing Set | 16517.30 |
| 6 | 1999-2004 Grand Cherokee, Rear Dana 44, Pinion Thrust Washer | 16584.08 |
| 7 | 1999-2000 Grand Cherokee, Rear Dana 44, Inner Pinion Oil Seal with 3/8 inch Ring Gear Bolts and Outer Pinion Oil Seal 1999-2004 2003-2010 Wrangler, 1999-2004 Grand Cherokee Dana 44, Pinion Shim Kit [0.035-0.039] | 16521.21 |
| 7 | 2003-2010 Wrangler, 1999-2004 Grand Cherokee Dana 44, Pinion Shim Kit [0.040-0.044] | 16519.02 |
| 7 | 2003-2010 Wrangler, 1999-2004 Grand Cherokee Dana 44, Pinion Shim Kit [0.045-0.049] | 16519.03 |
| 7 | 2003-2010 Wrangler, 1999-2004 Grand Cherokee Dana 44, Pinion Shim Kit [0.050-0.054] | 16519.04 |
| 7 | 2003-2010 Wrangler, 1999-2004 Grand Cherokee Dana 44, Pinion Shim Kit [0.050-0.054] | 16519.05 |
| 8A | 1996-1998 Grand Cherokee, Rear Dana 44, Inner Pinion Oil Seal | 16521.30 |
| 8A | 1999-2004 Grand Cherokee, Rear Dana 44, Inner Pinion Oil Seal | 16521.31 |
| 8A | 2001-2003 Grand Cherokee, Rear Dana 44, Standard Differential Inner Pinion Oil Seal | 16521.14 |
| 8B | 1999-2004 Grand Cherokee, Rear Dana 44, Outer Pinion Seal Only | 16521.32 |
| 9 | 1999-2004 Grand Cherokee, Rear Dana 44, Pinion Nut | 16584.10 |
| 10 | 1999-2004 Grand Cherokee, Rear Dana 44, Differential Cover with Hardware | 16595.84 |
| 10 | 1972-1975 CJ, 1986 CJ, 1987-2011 Wrangler, 1987-2001 Cherokee, 1999-2004 Grand Cherokee, Rear Dana 44, Heavy Duty Differential Cover 3/8" Thick Cast Steel [with Gasket and hardware] | 16595.44 |
| 10 | 1972-1975 CJ, 1986 CJ, 1987-2011 Wrangler, 1987-2001 Cherokee, 1999-2004 Grand Cherokee, Rear Dana 44, Heavy Duty Differential Skid Plate 3/8" Thick Cast Steel [with Gasket and hardware] | 16597.44 |

M. 1999-2010 Grand Cherokee Rear Dana-44

| Part# | Description | Part# |
|-------|---|----------|
| 11 | 1996-2004 Grand Cherokee, Rear Dana 44, Differential Bearing Kit | 16525.30 |
| 11 | 1999-2004 Grand Cherokee, Rear Dana 44, 3/8 Ring Gear Bolt [10 Required] | 16521.80 |
| 12 | 1948-69 CJ, 1972-1986 CJ, 1984-2001 XJ Cherokee, 1993-2004 Grand Cherokee, 2002-2007 Liberty, 1987-2010 Wrangler Rear Dana 44 with Flanged Axle, Front Dana 30 Rear Dana 35/44 Ring Gear Bolt Set [7/16 inch Bolts] | 16521.81 |
| 12 | 2000-2003 Grand Cherokee, Rear Dana 44, Standard Differential Case [with 7/16 inch Ring Gear Bolts] | 16503.64 |
| 12 | 3/30/2000-2003 Grand Cherokee, Rear Dana 44, Hydra-Loc Differential Case | 16505.39 |
| 12 | 2000-2003 Grand Cherokee, Differential Case Assembly Kit, [Rear Dana 44], 3.31 to 3.91 Ratio with Hydra Lok & ABS | 16505.37 |
| 12A | 1996-3/29/2000 Grand Cherokee, Rear Dana 44, Standard Differential Case Assembly Kit | 16505.35 |
| 12A | 3/30/2000-2003 Grand Cherokee, Rear Dana 44, Standard Differential Case Assembly Kit with Hydra-Loc | 16505.14 |
| 12A | 3/30/2000-2003 Grand Cherokee, Rear Dana 44, Hydra-Loc Differential Case Assembly | 16505.37 |
| 12A | 1996-3/29/2000 Grand Cherokee, Rear Dana 44, Trac-Lok Differential Case Assembly Kit 3.73 Ratio and Down | 16505.36 |
| 12A | 3/29/2000-2001 Grand Cherokee, Rear Dana 44, Trac-Lok Differential Case Assembly Kit | 16505.12 |
| 12B | 1996-2004 Grand Cherokee, Rear Dana 44, Trac-Loc Spider Gear Kit | 16507.41 |
| 13 | 1999-2004 Grand Cherokee, Rear Dana 44, Axle Shaft Retainer | 16534.21 |
| 14 | 1999-2004 Grand Cherokee, Rear Dana 44, Axle Shaft Bearing | 16536.31 |
| 15 | 1999-2004 Grand Cherokee, Rear Dana 44, Axle Shaft Oil Seal | 16534.22 |
| 15 | 1999-2001 Grand Cherokee, Rear Dana 44, Axle Plenum [with 3/8 inch Ring Gear Bolts] | 16508.41 |
| 16 | 1996-1998 Grand Cherokee, Rear Dana 44, Passenger Side Axle Shaft [without Hydra-Loc] | 16530.12 |
| 16 | 1999-2004 Grand Cherokee, Rear Dana 44, Passenger Side Axle Shaft [without Hydra-Loc] | 16530.72 |
| 16 | 1996-1998 Grand Cherokee, Rear Dana 44, Driver Side Axle Shaft [without Hydra-Loc] | 16530.11 |
| 16 | 1999-2004 Grand Cherokee, Rear Dana 44, Driver Side Axle Shaft [with Hydra-Loc] | 16530.73 |
| 16 | 1999-2004 Grand Cherokee, Rear Dana 44, Passenger Side Axle Shaft [with Hydra-Loc] | 16530.14 |
| 16 | 1999-2004 Grand Cherokee, Rear Dana 44, Driver Side Axle Shaft [with Hydra-Loc] | 16530.13 |
| | 1996-1998 Grand Cherokee, Rear Dana 44, Trac-Lok Disk Kit | 16508.21 |
| | 1999-2004 Grand Cherokee, Rear Dana 44, Trac-Lok Disk Kit | 16508.20 |

N. Yokes

| Part# | Description | Part# |
|-------|---|----------|
| | 1941-1971 CJ, Front Dana 25/27, Rear Dana 27, Yoke [10 Spline] | 16580.04 |
| | 1946-1971 CJ, Front Dana 27 Axle, Dana 18/20 and Quadratrax Transfer case, Yoke [10 Spline] | 16580.01 |
| | 1946-1971 CJ, Dana 18, Yoke | 18670.27 |
| | 1972-1986 CJ, Dana 30, Yoke [u-bolt style] [with Larger Dust Shield] | 16580.40 |

Axle



OMIX-ADA, Inc.

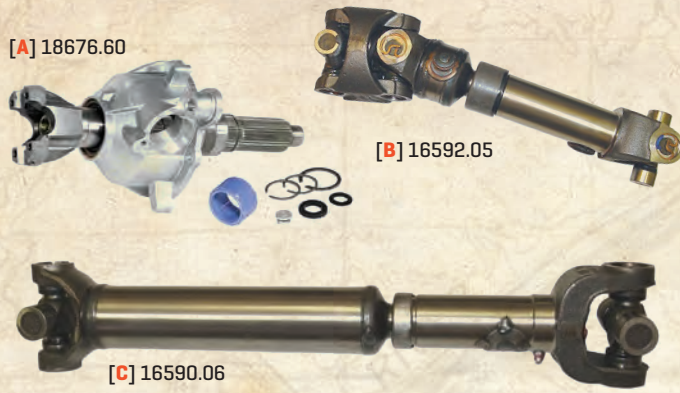

| A. Slip Yoke Eliminators | Part# |
|--|----------|
| 1988-2006 Wrangler [Except Rubicon], 1988-2001 Cherokee, SYE Kit for NP231 | 18676.60 |
| Pinion Yoke For SYE Kit | 18676.61 |
| Seal For SYE Kit | 18676.62 |
| Hardware For SYE Kit | 18676.64 |
| 1988-2006 Wrangler [Except Rubicon], 1988-2001 Cherokee, Mega Short SYE Kit for NP231* | 18676.72 |

| B. CV Drive Shaft for 1987-2011 Wrangler | Part# |
|---|----------|
| 1987-1993 Wrangler with Up to 3" Lift | 16592.01 |
| 1987-1995 Wrangler with Over 3" Lift | 16592.02 |
| 1994-1995 Wrangler with Up to 3" Lift* | 16592.03 |
| 1994-1995 Wrangler with Over 3" Lift* | 16592.04 |
| 1997-2006 Wrangler with 2" to 6" Lift | 16592.05 |
| 1997-2006 Wrangler with 3.5" to 6" Lift [Use with Mega Short SYE] | 16592.06 |
| 2007-2011 Wrangler 2 or 4 Door Front CV Style | 16592.22 |
| 2007-2011 Wrangler 2 Door Rear CV Style | 16592.21 |
| 2007-2011 Wrangler 4 Door Rear CV Style | 16592.20 |

| C. CJ Front Drive Shaft | Part# |
|---|----------|
| 1946-1966 CJ, 1950-1966 M38 and M38A1, Front Drive Shaft | 16590.01 |
| 1976-1979 CJ7 with 6 or 8 Cylinder and Automatic Transmission, Front Drive Shaft [36 3/8 inch] | 16590.02 |
| 1976-1976 CJ7 and CJ5 with 6 or 8 Cylinder and T150, Front Drive Shaft [26.5 inches] | 16590.03 |
| 1976-1976 CJ7 and CJ5 with 6 or 8 Cylinder and T18, 1981 CJ7 and CJ8 with 4 Cylinder and Automatic, Front Drive Shaft [30.25 inches] | 16590.04 |
| 1980-1981 CJ7 and CJ8 with 4 or 6 cylinder and SR4, 1982-1986 CJ5, CJ7 and CJ8 with 6 Cylinder and T4 or T5, Front Drive Shaft [31.75 inch] | 16590.06 |
| 1980-1986 CJ5, CJ7 and CJ8 with 6 or 8 Cylinder and T170, 1983-1986 CJ with 4 Cylinder and T4 or T5, Front Drive Shaft [29.5 inch] | 16590.07 |
| 1982-1986 CJ5 and CJ7 with 4 Cylinder and T176, Front Drive Shaft [27.25 inch] | 16590.08 |

| D. CJ Rear Drive Shafts | Part# |
|--|----------|
| 1976-1979 CJ7 with 6 or 8 Cylinder and T150, Rear Drive Shaft [26.5 inch] | 16591.01 |
| 1980 CJ7 with 4,6 or 8 Cylinder, and Automatic, 1981 CJ7 with 4,6 or 8 Cylinder and SR4, 1982-1986 CJ7 with 6 Cylinder and T4 or T5, Rear Drive Shaft [20.75 inch] | 16591.02 |
| 1980 CJ7 with 4,6 or 8 Cylinder with T170 or SR4, Rear Drive Shaft [23 5/8 inch] | 16591.03 |
| 1981-1986 CJ7 4, 6 or 8 Cylinder with T4, T5, or T170, Rear Drive Shaft [23 inch] | 16591.04 |
| 1981-1986 CJ8 7 6 or 8 Cylinder with Automatic, Rear Drive Shaft | 16591.05 |
| 1976-1979 CJ5 6 or 8 Cylinder with T150, Rear Drive Shaft [18.25 inch] | 16591.06 |
| 1980 CJ5 4 or 6 Cylinder with SR4, Rear Drive Shaft [13 7/8 inch] | 16591.07 |
| 1981-1986 CJ5 4 or 6 Cylinder with SR4, T4 or T5, Rear Drive Shaft [13 inch] | 16591.08 |
| 1981-1986 CJ8 4 or 6 Cylinder with T170, T4 or T5, Rear Drive Shaft [33 inch] | 16591.09 |
| 1981-1986 4 or 6 Cylinder with SR4, T4 or T5, Rear Drive Shaft [30.75 inch] | 16591.10 |
| 1946-1966 CJ, 1950-1966 M38 and M38A1, Rear Drive Shaft | 16591.11 |

| E. Wrangler Driveshafts | Part# |
|--|------------|
| 1987-1995 Wrangler with 6 Cylinder with Automatic, Front Drive Shaft | S-52088028 |
| 1993-1995 Wrangler 6 Cylinder, AX15 Manual, Rear Drive Shaft | 16591.21 |
| 1994-1995 Wrangler with Manual and 3" Slip Yoke, Rear Drive Shaft | S-52098221 |
| 1997-2002 Wrangler with 2.5L, AX15 Manual, Front Drive Shaft | 16590.22 |
| 1997-2002 Wrangler with 4.0L, AX15 Manual, Front Drive Shaft | 16590.23 |
| 2001-2002 Wrangler with 2.5L, Automatic, Front Drive Shaft | 16590.25 |
| 2001-2006 Wrangler with 4.0L, Manual, Dana 35, Rear Drive Shaft | 16591.24 |
| 2003-2006 Wrangler with 4 Cylinder, Automatic, Front Drive Shaft | 16590.27 |
| 2003-2006 Wrangler with 4.0L, Manual, Front Drive Shaft | 16590.24 |
| 2003-2006 Wrangler with 4 Cylinder, Manual, Front Drive Shaft | 16590.28 |
| 2003-2006 Wrangler with 4 Cylinder, Automatic, Dana 35, Rear Drive Shaft | 16591.25 |
| 2003-2006 Wrangler with 4 Cylinder, Manual, Dana 35, Rear Drive Shaft | 16591.26 |
| 2007-2012 Wrangler 2 or 4 Door, Front CV Style Drive Shaft NEW | 16592.22 |
| 2007-2012 Wrangler 2 Door, Rear CV Style Drive Shaft NEW | 16592.21 |
| 2007-2012 Wrangler 4 Door, Rear CV Style Drive Shaft NEW | 16592.20 |

| F. Cherokee Drive Shafts | Part# |
|--|----------|
| 1989-2000 Cherokee with 4.0L, Manual, Front Drive Shaft | 16590.30 |
| 1989-2000 Cherokee with 4.0L, Automatic, Front Drive Shaft | 16590.31 |
| 1995-2000 Cherokee [Export] with 2.5L Diesel, Front Drive Shaft | 16590.32 |
| 1982-1992 Cherokee [Export] with 4.0L, Manual, Front Drive Shaft | 16590.33 |
| 1987-1996 Cherokee with 4.0L, 4WD, Automatic and Dana 35, Rear Drive Shaft | 16591.30 |

| G. Grand Cherokee Drive Shafts | Part# |
|---|----------|
| 1992-1993 Grand Cherokee with 6 Cylinder, Automatic, Front Drive Shaft | 16590.40 |
| 1992-1996 Grand Cherokee with 6 Cylinder, 4WD, Ax15 Manual, Front Drive Shaft | 16590.41 |
| 1993 Grand Cherokee with 6 Cylinder, 4WD, AX15 Manual, Front Drive Shaft | 16591.40 |
| 1993-1995 Grand Cherokee with V8, Automatic, Front Drive Shaft | 16590.43 |
| 1994 Grand Cherokee with 6 Cylinder, A500 Automatic, Front Drive Shaft | 16590.42 |
| 1984-1995 Grand Cherokee with V8, A500 Automatic, Front Drive Shaft | 16590.44 |

| H. Misc. Drive Shaft Components | Part# |
|---|----------|
| 1994-1999 Cherokee, Dana 30, Front CV Boot Kit [Boot and Clamp] | 16527.30 |
| 1941-1999 CJ and Wrangler [Except 1967-1971 CJ], Front and Rear Drive Shaft U Joint 3 7/32 inch | 16585.01 |
| 1941-1999 CJ and Wrangler [Except 1967-1971 CJ], Front and Rear Drive Shaft U Joint 3 7/32 inch [Spicer] | 16585.02 |
| 1967-1971 CJ, Front Drive Shaft U-Joint | 16585.03 |
| 1967-1992 Wagoneer, Grand Cherokee U-Joint | 16585.04 |
| 1955-1999 CJ and Wrangler, Drive Shaft Greasable U-Joint Kit 3 7/32 inch [Spicer] | 16585.05 |
| 1994-1997 Wrangler, Rear Drive Shaft 3 5/8 inch U-Joint | 16585.06 |
| 1941-1969 CJ, 1972-1986 CJ, 1987-2010 Wrangler, 1984-2001 Cherokee, 1993-1998 Grand Cherokee, 2002-2007 Liberty, Dana 25/2730/44, AMC 20 Axle, Dana 20/300 and Quadtrac Transfer Case, U-bolt kit for Yoke part number 16580.02 Pair | 16582.01 |
| 1941-1969 CJ, 1972-1986 CJ, 1987-2010 Wrangler, 1984-2001 Cherokee, 1993-1998 Grand Cherokee, 2002-2007 Liberty, Dana 25/2730/44, AMC 20 Axle, Dana 20/300 and Quadtrac Transfer Case, U-bolt kit for Yoke part number 16580.02 Pair [Spicer Brand] | 16582.02 |
| 1981-1986 CJ, 1987-2010 Wrangler, 1981-2001 Cherokee, 1993-1998 Grand Cherokee, 2002-2007 Liberty, Front Dana 30, Rear Dana 35/44, AMC 20 Axle, Dana 300 Transfer Case, U-Bolt Kit for Yoke 16580.03 | 16582.03 |
| 1946-1971 CJ, Front or Rear Drive Shaft Sliding Yoke | 16580.51 |
| 1974-1986 CJ, Front or Rear Drive Shaft Sliding Yoke | 16580.52 |
| 1987-1995 Wrangler, Sliding Yoke | 16580.53 |
| 1975-1986 CJ and SJ, Front Drive Shaft Constant Velocity Yoke Thread Locker [5 ML], Red | 16580.54 |
| | 19201.02 |

All images are subject to be representative. More detailed information is available online.



OMIX-ADA, Inc.

[A] 16719.22



[B] 16720.01



[C] 16721.09



[D] S-52008647



[E] 16721.10

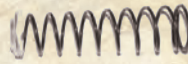

[E] 16718.02



A. Master Cylinders

Part#

| | |
|---|----------|
| 1941-1945 MB, 1941-1945 Ford GPW, 1945-1948 CJ2A, Brake Master Cylinder * | 16719.01 |
| 1948-1949 CJ2A, 1948-1953 CJ3A, 1953-1967 CJ3B, 1950-1952 M38, 1952-1971 M38A1, 1955-1966 CJ5, 1955-1966 CJ6, 1946-1964 Truck, 1946-1964 Station Wagon, 1948-1951 Jeepster, Brake Master Cylinder [Drum Brakes] * | 16719.03 |
| 1950-1952 M38, 1952-1971 M38A1, 1948-1964 Truck, 1948-1964 Station Wagon, 1948-1951 Jeepster, Master Cylinder [Drum Brakes] | 16719.03 |
| 1962-1965 Galdiator, 1962-1965 Wagon, Brake Master Cylinder, With 230 CI NEW | 16719.24 |
| 1972-1976 CJ5, 1972-1975 CJ6, 1976 CJ7, Brake Master Cylinder [Drum Brakes] | 16719.06 |
| 1974-1990 Cherokee / Grand Wagoneer [SJ], Brake Master Cylinder, With Power Brakes | 16719.18 |
| 1976-1978 CJ5, 1976-1978 CJ7, Master Cylinder [Disc Brakes], With Manual Brakes [For 6-Bolt Calipers] | 16719.09 |
| 1976-1978 CJ5, 1976-1978 CJ7, Master Cylinder [Disc Brakes], With Power Brakes [For 6-Bolt Calipers] | 16719.08 |
| 1977-1978 CJ5, 1977-1978 CJ7, Master Cylinder [Drum Brakes] | 16719.07 |
| 1978-1981 CJ5, 1978-1986 CJ7, 1981-1986 CJ8, Brake Master Cylinder [Disc Brake], With Manual Brakes [For 2-Bolt Calipers] | 16719.10 |
| 1978-1981 CJ5, 1978-1986 CJ7, 1981-1986 CJ8, Master Cylinder [Disc Brake], With Power Brakes [For 2-Bolt Calipers] | 16719.11 |
| 1981-1990 Grand Wagoneer [SJ], Brake Master Cylinder [All Models] | 16719.19 |
| 1982-1984 DJ5-M [Postal], Brake Master Cylinder | 16719.12 |
| 1987-1989 Wrangler, 1984-1989 Cherokee, Brake Master Cylinder | 16719.13 |
| 1990-1994 Wrangler, Brake Master Cylinder [Without ABS] | 16719.14 |
| 1990-1994 Cherokee, Brake Master Cylinder [Without ABS] | 16719.20 |
| 1990-1994 Cherokee [Export Models], Brake Master Cylinder | 16719.21 |
| 1992-1993 Cherokee, 1993 Grand Cherokee, Brake Master Cylinder [With ABS] | 16719.22 |
| 1993-1994 Grand Cherokee, 1994 Wrangler [With Rear Disc Brakes], 1994 Cherokee, Brake Master Cylinder [With ABS] | 16719.15 |
| 1995 Wrangler, Brake Master Cylinder [All Models] | 16719.16 |
| 1995-2001 Cherokee, 1995-1998 Grand Cherokee, Brake Master Cylinder [All Models] | 16719.23 |
| 1997-2006 Wrangler, Brake Master Cylinder [All Models] | 16719.17 |

B. Master Cylinder Repair Kits

Part#

| | |
|--|----------|
| 1941-1945 MB, 1941-1945 Ford GPW, 1945-1948 CJ2A, 1948-1953 CJ3A, 1953-1967 CJ3B, 1950-1952 M38, 1952-1971 M38A1, 1955-1966 CJ5, 1955-1966 CJ6, 1946-1964 Truck, 1946-1964 Station Wagon, 1948-1951 Jeepster, Brake Master Cylinder Repair Kit | 16720.01 |
| 1967-1971 CJ5, 1967-1971 CJ6, Brake Master Cylinder Repair Kit | 16720.02 |
| 1974-1980 Cherokee [SJ], Brake Master Cylinder Repair Kit | 16720.03 |
| 1978-1981 CJ5, 1978-1986 CJ7, 1981-1986 CJ8, Brake Master Cylinder Repair Kit [Disc Brake], With Manual Brakes [For 2-Bolt Calipers] NEW | 16720.06 |
| 1987-1989 Wrangler, 1984-1989 Cherokee, Brake Master Cylinder Repair Kit | 16720.04 |

C. Master Cylinder Components

Part#

| | |
|---|----------|
| 1941-1945 MB, 1941-1945 Ford GPW, 1945-1949 CJ2A, 1948-1953 CJ3A, 1953-1967 CJ3B, 1950-1952 M38, 1952-1971 M38A1, 1955-1966 CJ5, 1955-1966 CJ6, 1946-1964 Truck, 1946-1964 Station Wagon, 1948-1951 Jeepster, Brake Master Cylinder Fitting Bolt Kit, With Washers [3 Pieces] | 16721.09 |
| 1941-1945 MB, 1941-1945 Ford GPW, 1945-1949 CJ2A, 1948-1953 CJ3A, 1953-1967 CJ3B, 1950-1952 M38, 1952-1971 M38A1, 1955-1966 CJ5, 1955-1966 CJ6, 1946-1964 Truck, 1946-1964 Station Wagon, 1948-1951 Jeepster, Brake Master Cylinder Fitting Bolt | 16721.08 |
| 1941-1945 MB, 1941-1945 Ford GPW, 1945-1949 CJ2A, 1948-1953 CJ3A, 1953-1967 CJ3B, 1950-1952 M38, 1952-1971 M38A1, 1955-1966 CJ5, 1955-1966 CJ6, 1946-1964 Truck, 1946-1964 Station Wagon, 1948-1951 Jeepster, Brake Master Cylinder Washer, Between Master Cylinder & Fitting | 16721.06 |
| 1941-1945 MB, 1941-1945 Ford GPW, 1945-1949 CJ2A, 1948-1953 CJ3A, 1953-1967 CJ3B, 1950-1952 M38, 1952-1971 M38A1, 1955-1966 CJ5, 1955-1966 CJ6, 1946-1964 Truck, 1946-1964 Station Wagon, 1948-1951 Jeepster, Brake Master Cylinder Washer, Between Fitting & Bolt | 16721.07 |

D. Power Brake Booster & Master Cylinder Kits

Part#

| | |
|---|------------|
| 1976-1978 CJ5, 1976-1978 CJ7, Power Brake Booster Kit, With Master Cylinder [For 6-Bolt Calipers] NEW | 16718.21 |
| 1978-1981 CJ5, 1978-1986 CJ7, 1981-1986 CJ8, Power Brake Booster Kit, With Master Cylinder [For 2-Bolt Calipers] NEW | 16718.20 |
| 1995-1996 Cherokee [With 2.5L or 4.0L Engine], Power Brake Booster Kit, With Master Cylinder | S-52008647 |

E. Power Brake Booster

Part#

| | |
|---|----------|
| 1976-1983 CJ5, 1976-1986 CJ7, 1981-1986 CJ8, Power Brake Booster Bracket NEW | 16721.10 |
| 1982-1983 CJ5, 1982-1986 CJ7, 1982-1986 CJ8, Power Brake Booster | 16718.01 |
| 1984-1990 Cherokee [With 2.5L, 2.8L or 4.0L Engine], 1991-1994 Cherokee [Export Models] Power Brake Booster | 16718.04 |
| 1987-1990 Wrangler, Power Brake Booster | 16718.02 |
| 1995-1996 Cherokee [With 2.5L or 4.0L Engine], Power Brake Booster | 16718.05 |
| 1995-1998 Grand Cherokee, Power Brake Booster | 16718.06 |
| 1997-2001 Cherokee, Power Brake Booster | 16718.07 |

* CJ2A Before Serial #215649 + CJ2A After Serial #215849

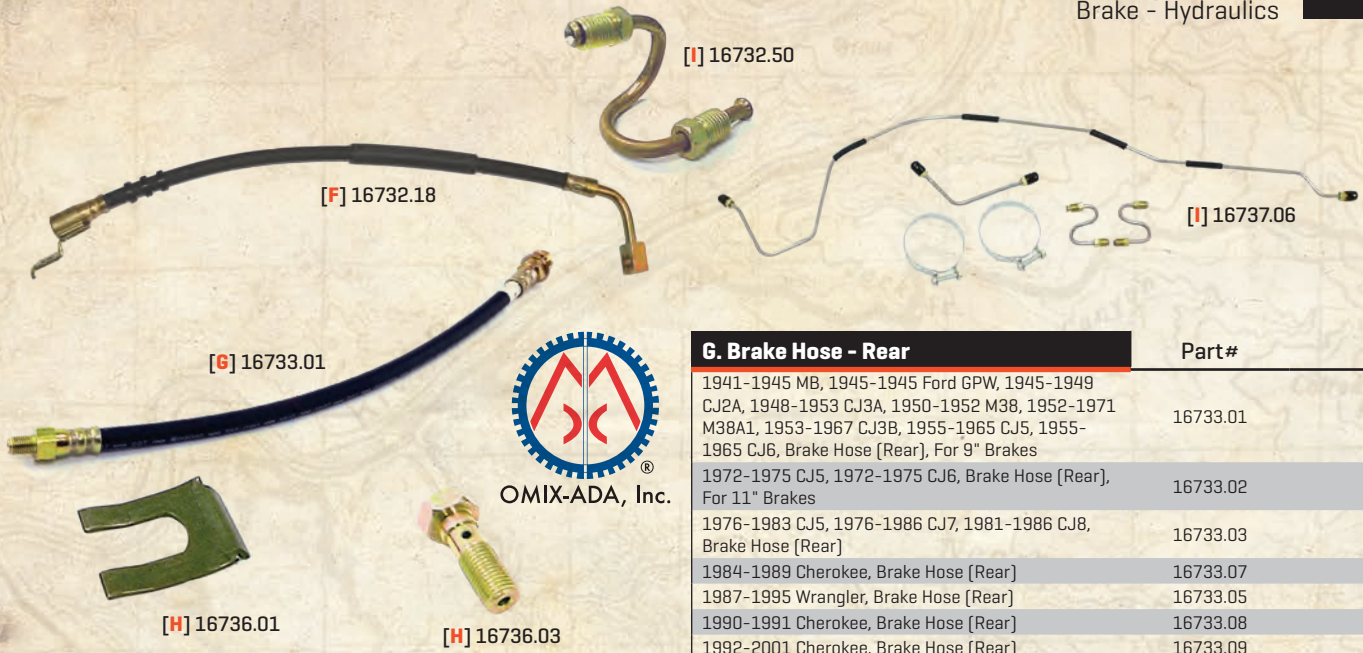

OMIX-ADA, Inc.

| F. Brake Hose - Front | Part# |
|--|----------|
| 1941-1945 MB, 1945-1945 Ford GPW, 1945-1949 CJ2A, 1948-1953 CJ3A, 1950-1952 M38, 1952-1971 M38A1, 1953-1967 CJ3B, 1955-1965 CJ5, 1955-1965 CJ6, Brake Hose [Front], For 9" Brakes | 16732.01 |
| 1941-1945 MB, 1945-1945 Ford GPW, 1945-1949 CJ2A, 1948-1953 CJ3A, 1950-1952 M38, 1952-1971 M38A1, 1953-1967 CJ3B, 1955-1965 CJ5, 1955-1965 CJ6, Brake Hose [Front Center], For 9" Brakes | 16732.02 |
| 1966-1971 CJ5, 1966-1971 CJ6, 1967-1970 Jeepster, Brake Hose [Front], For 10" Brakes | 16732.03 |
| 1972-1973 CJ5, 1972-1973 CJ6, Brake Hose [Front], For 11" Brakes | 16732.04 |
| 1974-1977 CJ5, 1974-1975 CJ6, 1976-1977 Brake Hose [Front], For 11" Drum Brakes | 16732.05 |
| 1974-1978 Cherokee / Grand Wagoneer [SJ], Brake Hose [Front] | 16732.19 |
| 1976-1978 CJ5, 1976-1978 CJ7, Brake Hose [Front], For Disc Brakes With 6-Bolt Calipers | 16732.06 |
| 1978-1981 CJ5, 1978-1981 CJ7, 1981 CJ8, Brake Hose [Front], For Disc Brakes With 2-Bolt Calipers | 16732.07 |
| 1982-1983 CJ5, Brake Hose [Front], For Disc Brakes | 16732.08 |
| 1982-1986 CJ7, 1982-1986 CJ8, Brake Hose [Front], For Disc Brakes, Left | 16732.09 |
| 1982-1986 CJ7, 1982-1986 CJ8, Brake Hose [Front], For Disc Brakes, Right | 16732.10 |
| 1984-1989 Cherokee, Brake Hose [Front], Left | 16732.17 |
| 1984-1989 Cherokee, Brake Hose [Front], Right | 16732.18 |
| 1987-1989 Wrangler, Brake Hose [Front], For Disc Brakes, Left | 16732.11 |
| 1987-1989 Wrangler, Brake Hose [Front], For Disc Brakes, Right | 16732.12 |
| 1990-1995 Wrangler, Brake Hose [Front], Without ABS, Left | 16732.13 |
| 1990-1995 Wrangler, Brake Hose [Front], Without ABS, Right | 16732.14 |
| 1990-2001 Cherokee, Brake Hose [Front], Left | 16732.21 |
| 1990-2001 Cherokee, Brake Hose [Front], Right | 16732.24 |
| 1997-2006 Wrangler, Brake Hose [Front], With or Without ABS, Left | 16732.15 |
| 1997-2006 Wrangler, Brake Hose [Front], With or Without ABS, Right | 16732.16 |
| 1999-2004 Grand Cherokee, Brake Hose [Front], Left NEW | 16732.25 |
| 1999-2004 Grand Cherokee, Brake Hose [Front], Right NEW | 16732.26 |
| 2005-2010 Grand Cherokee, 2006-2010 Commander, Brake Hose [Front], Left NEW * | 16732.27 |
| 2005-2010 Grand Cherokee, 2006-2010 Commander, Brake Hose [Front], Left NEW * | 16732.28 |

| G. Brake Hose - Rear | Part# |
|--|----------|
| 1941-1945 MB, 1945-1945 Ford GPW, 1945-1949 CJ2A, 1948-1953 CJ3A, 1950-1952 M38, 1952-1971 M38A1, 1953-1967 CJ3B, 1955-1965 CJ5, 1955-1965 CJ6, Brake Hose [Rear], For 9" Brakes | 16733.01 |
| 1972-1975 CJ5, 1972-1975 CJ6, Brake Hose [Rear], For 11" Brakes | 16733.02 |
| 1976-1983 CJ5, 1976-1986 CJ7, 1981-1986 CJ8, Brake Hose [Rear] | 16733.03 |
| 1984-1989 Cherokee, Brake Hose [Rear] | 16733.07 |
| 1987-1995 Wrangler, Brake Hose [Rear] | 16733.05 |
| 1990-1991 Cherokee, Brake Hose [Rear] | 16733.08 |
| 1992-2001 Cherokee, Brake Hose [Rear] | 16733.09 |
| 1993-1998 Grand Cherokee, Brake Hose [Rear] | 16733.10 |
| 1997-2006 Wrangler, Brake Hose [Rear], With Rear Drums | 16733.06 |

| H. Brake Hose Hardware | Part# |
|--|----------|
| 1976-1983 CJ5, 1976-1986 CJ7, 1981-1986 CJ8, 1974-1991 Cherokee / Grand Wagoneer [SJ], Brake Hose Clip | 16736.01 |
| 1976-1981 CJ5, 1976-1981 CJ7, 1981 CJ8, Brake Hose to Caliper Bolt [Front], For 2 or 6 Bolt Calipers | 16736.02 |
| 1976-1981 CJ5, 1976-1981 CJ7, 1981 CJ8, Brake Hose to Caliper Washer [Front], For 2 or 6 Bolt Calipers | 16751.09 |
| 1982-1983 CJ5, 1982-1986 CJ7, 1982-1986 CJ8, Brake Hose to Caliper Bolt [Front] | 16736.03 |
| 1982-1983 CJ5, 1982-1986 CJ7, 1982-1986 CJ8, Brake Hose to Caliper Washer [Front] | 16751.10 |
| 1987-2006 Wrangler, 1990-2001 Cherokee, Brake Hose to Caliper Washer [Front] | 16751.10 |

| I. Brake Lines - Standard Steel | Part# |
|---|----------|
| 1941-1945 MB, 1941-1945 Ford GPW, 1945-1949 CJ2A, 1948-1953 CJ3A, 1953-1967 CJ3B, 1950-1952 M38, 1952-1971 M38A1, 1955-1966 CJ5, 1955-1966 CJ6, Wheel Cylinder Brake Line | 16732.50 |
| 1941-1942 MB, 1941-1942 Ford GPW, Full Brake Line Set | 16737.01 |
| 1943-1945 MB, 1943-1945 Ford GPW, Full Brake Line Set | 16737.02 |
| 1945-1949 CJ2A, 1948-1953 CJ3A, Brake Line Set, Front, For Model 25 Axle | 16737.06 |
| 1945-1949 CJ2A, Brake Line Set, Rear, For Model 41 Axle | 16737.07 |
| 1945-1947 CJ2A, Brake Line Set, Frame Lines | 16737.09 |
| 1948-1949 CJ2A, 1949-1953 CJ3A, 1953-1955 CJ3B, Brake Line Set, Frame Lines | 16737.10 |
| 1949-1953 CJ3A, 1953-1967 CJ3B, Brake Line Set, Rear, For Dana 44 Axle | 16737.08 |
| 1950-1952 M38, Full Brake Line Set | 16737.03 |
| 1953-1971 M38A1, Full Brake Line Set | 16737.04 |
| 1955-1964 CJ5, Full Brake Line Set, For 9" Rear Brakes | 16737.05 |
| 1955-1964 CJ5, Full Brake Line Set, For 10" Rear Brakes | 16737.12 |
| 1956-1967 CJ3B, Brake Line Set, Frame Lines | 16737.11 |
| Universal Brake Line, 25' Coil, 13/16" X .028", With 16 Fittings | 16737.80 |
| Universal Brake Line, 25' Coil, 1/4" X .028", With 14 Fittings | 16737.81 |
| Universal Brake Line, 25' Coil, 5/16" X .028", With 10 Fittings | 16737.82 |
| Universal Brake Line, 25' Coil, 3/8" X .028", With 6 Fittings | 16737.83 |

* Except SRT8

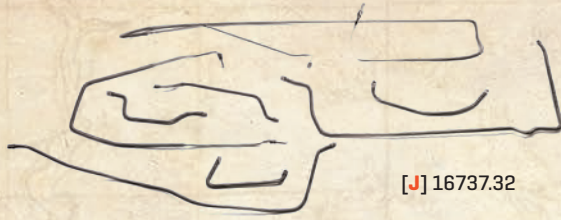

[J] 16737.32



[K] 16722.09

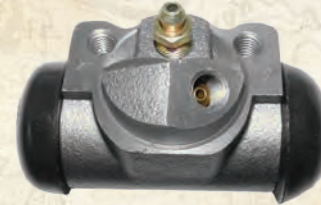

[L] 16723.10



OMIX-ADA, Inc.

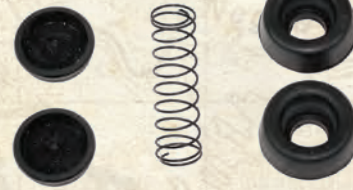

[M] 16724.04

J. Brake Lines - Stainless Steel

Part#

| | |
|--|----------|
| 1967-1968 CJ5, Full Brake Line Set [12 Pieces], With Drums, Stainless Steel | 16737.30 |
| 1977-1980 CJ5, Full Brake Line Set, With Manual Disc, Stainless Steel UPGRADE | 16737.36 |
| 1969-1971 CJ5, Full Brake Line Set [12 Pieces], With Drums, Stainless Steel UPGRADE | 16737.31 |
| 1972-1973 CJ5, Full Brake Line Set, With Drums, Stainless Steel UPGRADE | 16737.32 |
| 1974-1975 CJ5, Full Brake Line Set, With Drums, Stainless Steel UPGRADE | 16737.33 |
| 1976-1978 CJ5, Full Brake Line Set, With Drums, Stainless Steel UPGRADE | 16737.34 |
| 1976-1978 CJ5, Full Brake Line Set, With Power Drums, Stainless Steel UPGRADE | 16737.35 |
| 1976-1978 CJ7, Full Brake Line Set, With Drums, Stainless Steel UPGRADE | 16737.40 |
| 1976-1978 CJ7, Full Brake Line Set, With Power Drums, Stainless Steel UPGRADE | 16737.41 |
| 1976-1980 CJ7, Full Brake Line Set, With Manual Disc, Stainless Steel UPGRADE | 16737.42 |
| 1976-1980 CJ7, Full Brake Line Set, With Power Disc, Stainless Steel UPGRADE | 16737.43 |
| 1976-1979 CJ7 (With Quadratrac), Full Brake Line Set, With Drums, Stainless Steel UPGRADE | 16737.46 |
| 1976-1979 CJ7 (With Quadratrac), Full Brake Line Set, With Power Drums, Stainless Steel UPGRADE | 16737.47 |
| 1976-1979 CJ7 (With Quadratrac), Full Brake Line Set, With Disc, Stainless Steel UPGRADE | 16737.48 |
| 1976-1979 CJ7 (With Quadratrac), Full Brake Line Set, With Power Disc, Stainless Steel UPGRADE | 16737.49 |
| 1977-1980 CJ5, Full Brake Line Set, With Power Disc, Stainless Steel UPGRADE | 16737.37 |
| 1981-1983 CJ5, Full Brake Line Set, With Drums, Stainless Steel UPGRADE | 16737.38 |
| 1981-1983 CJ5, Full Brake Line Set, With Power Disc, Stainless Steel UPGRADE | 16737.39 |
| 1981-1986 CJ7, Full Brake Line Set, With Drums, Stainless Steel UPGRADE | 16737.44 |
| 1981-1986 CJ7, Full Brake Line Set, With Power Disc, Stainless Steel UPGRADE | 16737.45 |
| 1987-1995 Wrangler, Full Brake Line Set, With Disc, Stainless Steel UPGRADE | 16737.50 |
| 1997-2006 Wrangler, Full Brake Line Set, With Disc, Stainless Steel UPGRADE | 16737.51 |

K. Wheel Cylinders Front

Part#

| | |
|---|----------|
| 1941-1945 MB, 1945-1945 Ford GPW, 1945-1949 CJ2A, 1948-1953 CJ3A, Wheel Cylinder, (Front), LH or RH | 16722.01 |
| 1946-1964 Truck, 1946-1964 Station Wagon, Brake Shoes (Front), 11" x 2", LH | 16722.11 |
| 1946-1964 Truck, 1946-1964 Station Wagon, Brake Shoes (Front), 11" x 2", RH | 16722.12 |
| 1953-1967 CJ3B, 1952-1971 M38A1, 1955-1965 CJ5, 1955-1965 CJ6, Wheel Cylinder (Front), Without Angled Hose Connection, LH or RH | 16722.03 |
| 1963-1967 CJ3B, 1963-1966 CJ5, 1963-1966 CJ6, Wheel Cylinder (Front), With Angled Hose Connection, LH | 16722.05 |
| 1963-1967 CJ3B, 1963-1966 CJ5, 1963-1966 CJ6, Wheel Cylinder (Front), With Angled Hose Connection, RH | 16722.06 |
| 1966-1971 CJ5, 1966-1971 CJ6, 1967-1970 Jeepster, Wheel Cylinder (Front), For 10" x 2" Brakes, 1" Bore | 16722.07 |
| 1966-1971 CJ5, 1966-1971 CJ6, 1967-1970 Jeepster, Wheel Cylinder (Front), For 10" x 2" Brakes, 1-1/8" Bore | 16722.08 |
| 1972-1977 CJ5, 1972-1977 CJ6, 1976-1977 CJ7, Wheel Cylinder (Front), 11" x 2", LH | 16722.09 |
| 1972-1977 CJ5, 1972-1977 CJ6, 1976-1977 CJ7, Wheel Cylinder (Front), 11" x 2", RH | 16722.10 |
| 1979-1988 J20 Truck, Wheel Cylinder (Front), LH or RH | 16723.22 |
| 1982-1984 DJ5-M (Postal), Wheel Cylinder (Front), LH | 16723.21 |
| 1982-1984 DJ5-M (Postal), Wheel Cylinder (Front), RH | 16723.20 |

L. Wheel Cylinders Rear

Part#

| | |
|--|----------|
| 1941-1945 MB, 1945-1945 Ford GPW, 1945-1949 CJ2A, 1948-1953 CJ3A, Wheel Cylinder, (Rear), LH or RH, 3/4" Bore | 16723.01 |
| 1946-1964 Truck, 1946-1964 Station Wagon, Wheel Cylinders (Rear), 11" x 2", LH | 16723.13 |
| 1946-1964 Truck, 1946-1964 Station Wagon, Wheel Cylinders (Rear), 11" x 2", RH | 16723.14 |
| 1953-1967 CJ3B, 1952-1971 M38A1, 1955-1965 CJ5, 1955-1965 CJ6, Wheel Cylinders (Rear), 9" x 1-3/4", LH or RH | 16723.03 |
| 1955-1964 DJ3A (Postal), Wheel Cylinder (Rear), 1" Bore NEW | 16722.14 |
| 1966-1971 CJ5, 1966-1971 CJ6, 1967-1970 Jeepster, Wheel Cylinder (Rear), For 10" x 2" Brakes, LH | 16723.05 |
| 1966-1971 CJ5, 1966-1971 CJ6, 1967-1970 Jeepster, Wheel Cylinder (Rear), For 10" x 2" Brakes, RH | 16723.06 |
| 1972-1974 CJ5, 1972-1974 CJ6, Wheel Cylinder (Rear), For 11" x 2" Unfinned Drums, LH | 16723.07 |
| 1972-1974 CJ5, 1972-1974 CJ6, Wheel Cylinder (Rear), For 11" x 2" Unfinned Drums, RH | 16723.08 |
| 1976-1983 CJ5, 1978-1986 CJ7, 1981-1986 CJ8, 1984-1989 Cherokee, 1987-1989 Wrangler, Wheel Cylinder (Rear), 10" or 11" Brakes, Left | 16723.09 |
| 1976-1983 CJ5, 1978-1986 CJ7, 1981-1986 CJ8, 1984-1989 Cherokee, 1987-1989 Wrangler, Wheel Cylinder (Rear), 10" or 11" Brakes, Right | 16723.10 |
| 1978-1991 Cherokee / Grand Cherokee, Wheel Cylinder (Rear), LH or RH | 16723.12 |
| 1979-1988 J20 Truck, Wheel Cylinder (Rear), LH or RH | 16723.22 |
| 1990-2000 Wrangler, 1990-2001 Cherokee, 1993-1998 Grand Cherokee, Wheel Cylinder (Rear), 9" x 2.5" Without ABS, LH or RH * | 16723.11 |
| 2000-2006 Wrangler, 1991-2001 Cherokee, 1993-1998 Grand Cherokee, Wheel Cylinders (Rear), 10" x 1-3/4", With ABS, LH or RH * | 16723.18 |
| 2002 Liberty, Wheel Cylinder (Rear), For 10" x 1-3/4" Drum | 16723.19 |

M. Wheel Cylinder Repair Kits

Part#

| | |
|--|----------|
| Wheel Cylinder Repair Kit, For All 3/4" Bore Wheel Cylinders | 16724.01 |
| Wheel Cylinder Repair Kit, For All 13/16" Bore Wheel Cylinders | 16724.02 |
| Wheel Cylinder Repair Kit, For All 7/8" Bore Wheel Cylinders | 16724.03 |
| Wheel Cylinder Repair Kit, For All 15/16" Bore Wheel Cylinders | 16724.06 |
| Wheel Cylinder Repair Kit, For All 1" Bore Wheel Cylinders | 16724.04 |
| Wheel Cylinder Repair Kit, For All 1-1/8" Bore Wheel Cylinders | 16724.05 |



[N] 16745.01



[O] 16748.01



OMIX-ADA, Inc.



[Q] 16749.01

[P] 16747.03



[R] 16706.01

N. Disc Brake Calipers - Front Part#

| | |
|---|----------|
| 1976-1978 CJ5, 1976-1978 CJ7, Disc Brake Calipers (Front), For 6-Bolt Bracket, Left NEW | 16744.01 |
| 1976-1978 CJ5, 1976-1978 CJ7, Disc Brake Calipers (Front), For 6-Bolt Bracket, Right NEW | 16744.02 |
| 1978-1981 CJ5, 1978-1981 CJ7, 1981 CJ8, Disc Brake Calipers (Front), For 2-Bolt Bracket, Left NEW | 16744.03 |
| 1978-1981 CJ5, 1978-1981 CJ7, 1981 CJ8, Disc Brake Calipers (Front), For 2-Bolt Bracket, Right NEW | 16744.04 |
| 1982-1983 CJ5, 1982-1986 CJ7, 1982-1986 CJ8, 1984-1989 Cherokee, 1987-1989 Wrangler, Disc Brake Caliper, Left NEW | 16744.07 |
| 1982-1983 CJ5, 1982-1986 CJ7, 1982-1986 CJ8, 1984-1989 Cherokee, 1987-1989 Wrangler, Disc Brake Caliper, Right NEW | 16744.06 |
| 1990-2006 Wrangler, 1990-2001 Cherokee (4WD), 1993-1998 Grand Cherokee, Disc Brake Caliper (Front), Left | 16745.01 |
| 1990-2006 Wrangler, 1990-2001 Cherokee (4WD), 1993-1998 Grand Cherokee, Disc Brake Caliper (Front), Right | 16745.02 |
| 1999-2004 Grand Cherokee, Disc Brake Caliper (Front), Akebono Style, Left * | 16745.07 |
| 1999-2004 Grand Cherokee, Disc Brake Caliper (Front), Akebono Style, Right * | 16745.06 |
| 2002-2007 Liberty, Disc Brake Caliper (Front), Left | 16745.05 |
| 2002-2007 Liberty, Disc Brake Caliper (Front), Right | 16745.04 |

O. Disc Brake Caliper Hardware Kit Part#

| | |
|--|----------|
| 1976-1978 CJ5, 1976-1978 CJ7, Disc Brake Caliper Hardware Kit (Front), For 6-Bolt Caliper, LH or RH | 16748.01 |
| 1978-1981 CJ5, 1978-1981 CJ7, 1981 CJ8, Disc Brake Caliper Hardware Kit (Front), For 2-Bolt Caliper, LH or RH | 16748.02 |
| 1982-1983 CJ5, 1982-1986 CJ7, 1982-1986 CJ8, 1984-1989 Cherokee, 1987-1989 Wrangler, Disc Brake Caliper Hardware Kit (Front), LH or RH | 16748.03 |
| 1990-2006 Wrangler, 1990-2001 Cherokee (4WD), 1993-1998 Grand Cherokee, Disc Brake Caliper Hardware Kit (Front), LH or RH | 16748.04 |
| 1999-2004 Grand Cherokee, Disc Brake Caliper Hardware Kit (Front), Akebono Style, LH or RH | 16748.05 |

P. Disc Brake Caliper Pistons & Seals Part#

| | |
|---|----------|
| 1976-1978 CJ5, 1976-1978 CJ7, Disc Brake Caliper Piston & Seal Kit (Front), For 6-Bolt Caliper, LH or RH | 16747.01 |
| 1978-1981 CJ5, 1978-1981 CJ7, 1981 CJ8, Disc Brake Caliper Piston & Seal Kit (Front), For 2-Bolt Caliper, LH or RH | 16747.02 |
| 1982-1983 CJ5, 1982-1986 CJ7, 1982-1986 CJ8, 1984-1989 Cherokee, 1987-1989 Wrangler, Disc Brake Caliper Seal Kit (Front), LH or RH | 16746.01 |
| 1982-1983 CJ5, 1982-1986 CJ7, 1982-1986 CJ8, 1984-1989 Cherokee, 1987-1989 Wrangler, Disc Brake Caliper Piston & Seal Kit (Front), LH or RH | 16747.03 |
| 1990-2006 Wrangler, 1990-2001 Cherokee (4WD), 1993-1998 Grand Cherokee, Disc Brake Caliper Seal Kit (Front), LH or RH | 16747.04 |
| 1999-2002 Grand Cherokee, Disc Brake Caliper Piston & Seal Kit (Front), Teves Style, LH or RH | 16747.05 |
| 2002-2007 Liberty, Disc Brake Caliper Seal (Front), LH or RH | 16746.02 |
| 2002-2007 Liberty, Disc Brake Caliper Piston (Front), LH or RH | 16746.50 |

Q. Disc Brake Caliper Bolts & Pins Part#

| | |
|--|----------|
| 1976-1981 CJ5, 1976-1981 CJ7, 1981 CJ8, Disc Brake Caliper Bolt (Front), For 2 or 6 Bolt Calipers, LH or RH | 16749.01 |
| 1982-1983 CJ5, 1982-1986 CJ7, 1982-1986 CJ8, 1984-1989 Cherokee, 1987-1989 Wrangler, Disc Brake Caliper Bolt (Front), LH or RH | 16749.02 |
| 1990-2006 Wrangler, 1990-2001 Cherokee (4WD), 1993-1998 Grand Cherokee, Disc Brake Caliper Pin (Front), LH or RH | 16749.09 |
| 2007-2011 Wrangler, Disc Brake Caliper Pin Set (Front) NEW | 16749.10 |
| 2007-2011 Wrangler, Disc Brake Caliper Pin Set (Rear) NEW | 16749.11 |
| 1982-1983 CJ5, 1982-1986 CJ7, 1982-1986 CJ8, 1984-1989 Cherokee, 1987-1989 Wrangler, Disc Brake Caliper Bushing (Front), LH or RH | 16749.05 |
| 1990-2006 Wrangler, 1990-2001 Cherokee (4WD), 1993-1998 Grand Cherokee, Disc Brake Caliper Bushing (Front), LH or RH | 16749.06 |
| 1982-1983 CJ5, 1982-1986 CJ7, 1982-1986 CJ8, 1984-1989 Cherokee, 1987-1989 Wrangler, Disc Brake Caliper Sleeve (Front), LH or RH | 16749.07 |
| 1990-2006 Wrangler, 1990-2001 Cherokee (4WD), 1993-1998 Grand Cherokee, Disc Brake Caliper Sleeve (Front), LH or RH | 16749.08 |
| 1982-1983 CJ5, 1982-1986 CJ7, 1982-1986 CJ8, 1984-2001 Cherokee, 1987-2006 Wrangler, 1993-1998 Grand Cherokee, Disc Brake Caliper Anti-Rattle Clip (Front), LH or RH | 16749.04 |
| 1982-1983 CJ5, 1982-1986 CJ7, 1982-1986 CJ8, 1984-2001 Cherokee, 1987-2006 Wrangler, 1993-1998 Grand Cherokee, Disc Brake Caliper Bleeder Screw (Front), LH or RH | 16749.03 |

R. Wheel Bearings Part#

| | |
|---|----------|
| 1941-1945 MB (Front & Rear), 1945-1945 Ford GPW (Front & Rear), 1945-1949 CJ2A, 1948-1953 CJ3A, 1953-1967 CJ3B, 1950-1952 M38, 1952-1971 M38A1, 1955-1966 CJ5, 1955-1966 CJ6, Wheel Bearing Cone (Front), Inner and Outer, With Dana 25 | 16706.01 |
| 1941-1945 MB (Front & Rear), 1945-1945 Ford GPW (Front & Rear), 1945-1949 CJ2A, 1948-1953 CJ3A, 1953-1967 CJ3B, 1950-1952 M38, 1952-1971 M38A1, 1955-1966 CJ5, 1955-1966 CJ6, Wheel Bearing Cup (Front), Inner and Outer, With Dana 25 | 16707.01 |
| 1960-1967 CJ3B, 1960-1983 CJ5, 1960-1966 CJ6, 1976-1986 CJ7, 1981-1986 CJ8 Wheel Bearing Cone (Front), Inner & Outer With Dana 27, Outer With Dana 30 | 16706.02 |
| 1960-1967 CJ3B, 1960-1983 CJ5, 1960-1966 CJ6, 1976-1986 CJ7, 1981-1986 CJ8 Wheel Bearing Cup (Front), Inner & Outer With Dana 27, Outer With Dana 30 | 16707.02 |
| 1976-1983 CJ5, 1976-1986 CJ7, 1981-1986 CJ8 Wheel Bearing Cone (Front), Inner, With Dana 30 | 16706.03 |
| 1976-1983 CJ5, 1976-1986 CJ7, 1981-1986 CJ8 Wheel Bearing Cup (Front), Inner, With Dana 30 | 16707.03 |
| 1984-1989 Cherokee, 1987-1989 Wrangler, Wheel Bearing Assembly (Front), Inner or Outer, With Dana 30 | 16709.01 |

* Replaces Teves Style Caliper



[S] 16705.01



[T] 16708.01

[U] 16712.01



[V] 16710.01

[Y] 16715.01



OMIX-ADA, Inc.



[W] 16714.01

S. Wheel Hubs

Part#

| | |
|--|----------|
| 1941-1945 MB [Front & Rear], 1945-1945 Ford GPW [Front & Rear], 1945-1949 CJ2A, 1948-1953 CJ3A, 1953-1967 CJ3B, 1950-1952 M38, 1952-1971 M38A1, 1955-1968 CJ5, 1955-1968 CJ6, Wheel Hub [Front] | 16705.03 |
| 1941-1945 MB [Front & Rear], 1945-1945 Ford GPW [Front & Rear], 1945-1949 CJ2A, 1948-1953 CJ3A, 1953-1967 CJ3B, 1950-1952 M38, 1952-1971 M38A1, 1955-1968 CJ5, 1955-1968 CJ6, Wheel Hub Assembly [Front], With LH Threaded Wheel Studs | 16705.01 |
| 1941-1945 MB [Front & Rear], 1945-1945 Ford GPW [Front & Rear], 1945-1949 CJ2A, 1948-1953 CJ3A, 1953-1967 CJ3B, 1950-1952 M38, 1952-1971 M38A1, 1955-1968 CJ5, 1955-1968 CJ6, Wheel Hub Assembly [Front], With RH Threaded Wheel Studs | 16705.02 |
| 1966-1981 CJ5, 1966-1975 CJ6, 1976-1981 CJ7, Wheel Hub [Front], For Models With 6 Bolt Locking Hubs, LH or RH | 16705.04 |
| 1981-1983 CJ5, 1981-1986 CJ7, 1981-1986 CJ8, Wheel Hub [Front], For Models With 5 Bolt Locking Hubs, LH or RH | 16705.05 |
| 1984-1989 Cherokee, 1987-1989 Wrangler, Wheel Hub Assembly [Front], LH or RH | 16705.06 |
| 1990-1999 Wrangler, 1990-1999 Cherokee, 1993-1998 Grand Cherokee, Wheel Hub Assembly [Front], LH or RH | 16705.07 |
| 1999-2004 Grand Cherokee, Wheel Hub Assembly [Front], LH or RH | 16705.09 |
| 2000-2006 Wrangler, 2000-2001 Cherokee, Wheel Hub Assembly [Front], LH or RH | 16705.08 |
| 2002-2007 Liberty, Wheel Hub Assembly [Front], With 4 Wheel Disc & ABS, Left NEW | 16705.11 |
| 2002-2007 Liberty, Wheel Hub Assembly [Front], With 4 Wheel Disc & ABS, Right NEW | 16705.12 |
| 2002-2005 Liberty, Wheel Hub Assembly [Front], Without ABS, LH or RH | 16705.10 |
| 2005-2010 Grand Cherokee, Wheel Hub Assembly [Front] NEW | 16705.16 |
| 2005-2010 Grand Cherokee, Wheel Hub Assembly [Rear] NEW | 16705.60 |
| 2007-2011 Wrangler, Wheel Hub Assembly [Front] NEW | 16705.14 |
| 2008-2011 Liberty, Wheel hub Assembly [Front] NEW | 16705.15 |

T. Hub Bearing Oil Seals

Part#

| | |
|--|----------|
| 1941-1945 MB [Front & Rear], 1945-1945 Ford GPW [Front & Rear], 1945-1949 CJ2A, 1948-1953 CJ3A, 1953-1967 CJ3B, 1950-1952 M38, 1952-1971 M38A1, 1955-1966 CJ5, 1955-1966 CJ6, Wheel Hub Bearing Seal [Front], With Dana 25 | 16708.01 |
| 1960-1967 CJ3B, 1960-1976 CJ5, 1960-1975 CJ6, 1976 CJ7, Wheel Hub Bearing Seal [Front], With Dana 27 or Dana 30 | 16708.02 |
| 1974-1991 Cherokee / Grand Wagoneer [SJ], Wheel Hub Bearing Seal [Front] | 16708.05 |
| 1976-1983 CJ5, 1976-1986 CJ7, 1981-1986 CJ8, Wheel Hub Bearing Seal [Front], With Dana 30 | 16708.03 |
| 1984-1989 Cherokee, 1987-1989 Wrangler, Wheel Hub Bearing Seal [Front], Inner, With Dana 30 | 16708.04 |
| 1984-1989 Cherokee, 1987-1989 Wrangler, Wheel Hub Bearing Seal [Front], Center, With Dana 30 | 16708.06 |

U. Bearing Cap

Part#

| | |
|--|----------|
| 1941-1945 MB [Front & Rear], 1945-1945 Ford GPW [Front & Rear], 1945-1949 CJ2A, 1948-1953 CJ3A, 1953-1967 CJ3B, 1950-1952 M38, 1952-1971 M38A1, 1955-1968 CJ5, 1955-1968 CJ6, Wheel Hub Bearing Cap, With Dana 25 or dana 27 | 16712.01 |
|--|----------|

V. Spindle Nuts

Part#

| | |
|--|----------|
| 1941-1945 MB [Front & Rear], 1945-1945 Ford GPW [Front & Rear], 1945-1949 CJ2A, 1948-1953 CJ3A, 1953-1967 CJ3B, 1950-1952 M38, 1952-1971 M38A1, 1955-1966 CJ5, 1955-1966 CJ6, Spindle Nut Kit [Front], With Dana 25, Dana 27 & Dana 30 * | 16710.01 |
| 1941-1945 MB [Front & Rear], 1945-1945 Ford GPW [Front & Rear], 1945-1949 CJ2A, 1948-1953 CJ3A, 1953-1967 CJ3B, 1950-1952 M38, 1952-1971 M38A1, 1955-1966 CJ5, 1955-1966 CJ6, Spindle Nut Socket, With Dana 25, Dana 27 & Dana 30 | 16711.01 |

W. Wheel Studs

Part#

| | |
|---|----------|
| 1941-1945 MB [Front & Rear], 1945-1945 Ford GPW [Front & Rear], 1945-1949 CJ2A, 1948-1953 CJ3A, Wheel Stud [Front or Rear], LH Thread | 16714.01 |
| 1941-1945 MB [Front & Rear], 1945-1945 Ford GPW [Front & Rear], 1945-1949 CJ2A, 1948-1953 CJ3A, Wheel Stud [Front or Rear], RH Thread | 16714.02 |
| 1965-1978 CJ5, 1965-1975 CJ6, 1976-1978 CJ7, Wheel Stud, Front [With Drum Brakes] | 16714.03 |
| 1972-1983 CJ5, 1972-1975 CJ6, 1976-1986 CJ7, 1981-1986, Wheel Stud, Front [With AMC 20 or Dana 44] | 16714.06 |
| 1977-1981 CJ5, 1977-1986 CJ7, 1981-1986 CJ8, Wheel Stud, Front [With Disc Brakes] | 16714.04 |
| 1990-1999 Wrangler, 1993-1999 Cherokee, 1993-1998 Grand Cherokee, Wheel Stud [Front] NEW | 16714.07 |
| 2001-2002 Wrangler, Wheel Stud, Rear | 16714.10 |
| 2003-2006 Wrangler, Wheel Stud, Rear | 16714.11 |

Y. Lug Nuts

Part#

| | |
|--|----------|
| 1941-1945 MB [Front & Rear], 1945-1945 Ford GPW [Front & Rear], 1945-1946 CJ2A, Lug Nut [Front or Rear], LH Thread | 16715.01 |
| 1941-1945 MB [Front & Rear], 1945-1945 Ford GPW [Front & Rear], 1945-1946 CJ2A, Lug Nut [Front or Rear], RH Thread | 16715.02 |
| 1946-1949 CJ2A, 1948-1953 CJ3A, 1953-1967 CJ3B, 1950-1952 M38, 1952-1971 M38A1, 1955-1971 CJ5, 1955-1971 CJ6, Lug Nut [Front or Rear], LH Thread | 16715.03 |
| 1946-1949 CJ2A, 1948-1953 CJ3A, 1953-1967 CJ3B, 1950-1952 M38, 1952-1971 M38A1, 1955-1983 CJ5, 1955-1975 CJ6, 1976-1986 CJ7, 1981-1986 CJ8, Lug Nut [Front or Rear], RH Thread | 16715.04 |
| 1946-1949 CJ2A, 1948-1953 CJ3A, 1953-1967 CJ3B, 1950-1952 M38, 1952-1971 M38A1, 1955-1983 CJ5, 1955-1975 CJ6, 1976-1986 CJ7, 1981-1986 CJ8, Lug Nut [Front or Rear], RH Thread, Chrome | 16715.05 |
| 1987-2011 Wrangler, 1984-2001 Cherokee, 1993-2010 Grand Cherokee, 2002-2010 Liberty, Lug Nut, RH Thread, Chrome NEW | 16715.06 |

* Includes 2 Spindle Nuts & 2 Washers



[Z-1] 16701.01



[Z-3] 16738.01



[Z-2] 16726.09

| Z. Drum Brake Kits | Part# |
|--|----------|
| 1941-1945 MB, 1945-1945 Ford GPW, 1945-1949 CJ2A, 1948-1953 CJ3A, Brake Drum Rebuild Kit (Front or Rear), 9" x 1-3/4" NEW * | 16767.01 |
| 1948-1949 CJ2A, 1948-1953 CJ3A, Brake Drum Rebuild Kit (Front or Rear), 9" x 1-3/4" NEW + | 16767.02 |
| 1953-1967 CJ3B, 1952-1971 M38A1, 1955-1965 CJ5, 1955-1965 CJ6, Brake Drum (Front or Rear), 9" x 1-3/4" NEW | 16767.03 |
| 1978-1983 CJ5, 1978-1986 CJ7, 1981-1986 CJ8, Brake Drum Rebuild Kit (Rear), 10" x 2" NEW | 16766.04 |
| 1984-1989 Cherokee, 1987-1989 Wrangler, Brake Drum Rebuild Kit (Rear), 10" x 1-3/4" With Dana 35 NEW | 16766.02 |
| 1986-1989 Cheokee, 1987-1993 Wrangler, Brake Drum Rebuild Kit (Rear), 10" x 2.5" With Dana 44 NEW | 16766.03 |
| 1990-2006 Wrangler, 1990-2001 Cherokee, 1993-1998 Grand Cherokee, Brake Drum Rebuild Kit (Rear), 9" x 2.5" With Dana 35 NEW | 16766.01 |
| 1974-1978 CJ5, 1974-1975 CJ6, 1976-1978 CJ7, Brake Drum Rebuild Kit (Front or Rear), 11" x 2", Finned NEW | 16765.01 |

| Z-1. Brake Drums | Part# |
|--|----------|
| 1941-1945 MB, 1945-1945 Ford GPW, 1945-1949 CJ2A, 1948-1953 CJ3A, Brake Drum (Front or Rear), 9" x 1-3/4" | 16701.01 |
| 1946-1955 Station Wagon (2WD with Planar Suspension), 1948-1951 Jeepster, Brake Drum (Front or Rear), 10" x 1-3/4" | 16701.11 |
| 1946-1964 Truck, 1946-1964 Station Wagon, Brake Drum (Front or Rear), 11" x 2" | 16701.10 |
| 1953-1967 CJ3B, 1952-1971 M38A1, 1955-1965 CJ5, 1955-1965 CJ6, Brake Drum (Front or Rear), 9" x 1-3/4" | 16701.02 |
| 1966-1971 CJ5, 1966-1971 CJ6, 1967-1970 Jeepster, Brake Drum (Front or Rear), 10" x 2" | 16701.03 |
| 1972-1974 CJ5, 1972-1974 CJ6, Brake Drum (Front or Rear), 11" x 2", Unfinned | 16701.04 |
| 1974-1978 CJ5, 1974-1975 CJ6, 1976-1978 CJ7, Brake Drum (Front or Rear), 11" x 2", Finned | 16701.05 |
| 1974-1978 Cherokee / Grand Cherokee, Brake Drum (Front or Rear), Unfinned | 16701.12 |
| 1978-1983 CJ5, 1978-1986 CJ7, 1981-1986 CJ8, Brake Drum (Rear), 10" x 2" | 16701.06 |
| 1978-1991 Cherokee / Grand Cherokee, Brake Drum (Rear), Finned | 16701.13 |
| 1982-1984 DJ5-M (Postal), Brake Drum (Front), 10.31" OD | 16701.14 |
| 1982-1984 DJ5-M (Postal), Brake Drum (Rear), 10.625" OD | 16701.15 |
| 1984-1989 Cherokee, 1987-1989 Wrangler, Brake Drum (Rear), 10" x 1-3/4" With Dana 35 | 16701.07 |
| 1986-1989 Cheokee, 1987-1993 Wrangler, Brake Drum (Rear), 10" x 2.5" With Dana 44 | 16701.09 |
| 1990-2006 Wrangler, 1990-2001 Cherokee, 1993-1998 Grand Cherokee, Brake Drum (Rear), 9" x 2.5" With Dana 35 | 16701.08 |
| 1991-2001 Cherokee, 1993-1998 Grand Cherokee, Brake Drum (Rear), 10" x 1-3/4" | 16701.16 |
| 2002 Liberty, Brake Drum (Rear), 10" x 1-3/4" | 16701.17 |

| Z-2. Brake Shoes | Part# |
|--|----------|
| 1941-1945 MB, 1945-1945 Ford GPW, 1945-1949 CJ2A, 1948-1953 CJ3A, Brake Shoes (Front or Rear), 9" x 1-3/4" | 16726.01 |
| 1941-1945 MB, 1945-1945 Ford GPW, 1945-1949 CJ2A, 1948-1953 CJ3A, Brake Shoe Linings, (Front or Rear), With Rivets, 9" x 1-3/4" | 16727.01 |
| 1946-1964 Truck, 1946-1964 Station Wagon, Brake Shoes (Front or Rear), 11" x 2" | 16726.11 |
| 1953-1967 CJ3B, 1952-1971 M38A1, 1955-1965 CJ5, 1955-1965 CJ6, Brake Shoes (Front or Rear), 9" x 1-3/4" | 16726.02 |
| 1966-1971 CJ5, 1966-1971 CJ6, 1967-1970 Jeepster, Brake Shoes (Front), 10" x 2" | 16726.03 |
| 1972-1974 CJ5, 1972-1974 CJ6, Brake Shoes (Front or Rear), 11" x 2" | 16726.04 |
| 1974-1978 Cherokee / Grand Cherokee, Brake Shoes (Front or Rear), For Unfinned Drums | 16726.13 |
| 1978-1983 CJ5, 1978-1986 CJ7, 1981-1986 CJ8, Brake Shoes (Rear), 10" x 2" | 16726.05 |
| 1978-1983 CJ5, 1978-1986 CJ7, 1981-1986 CJ8, Brake Shoes (Rear), 10" x 2", Genuine Bendix Brand UPGRADE | 16726.16 |
| 1978-1991 Cherokee / Grand Cherokee, Brake Shoes (Rear), For Finned Drum | 16726.12 |
| 1982-1984 DJ5-M (Postal), Brake Shoes (Front), 10.31" OD | 16726.09 |
| 1982-1984 DJ5-M (Postal), Brake Shoes (Rear), 10.625" OD | 16726.10 |
| 1984-1989 Cherokee, 1987-1989 Wrangler, Brake Shoes (Rear), 10" x 1-3/4" With Dana 35 | 16726.05 |
| 1984-1989 Cherokee, 1987-1989 Wrangler, Brake Shoes (Rear), 10" x 1-3/4" With Dana 35, Genuine Bendix Brand UPGRADE | 16726.16 |
| 1986-1989 Cheokee, 1987-1993 Wrangler, Brake Shoes (Rear), 10" x 2.5" With Dana 44 | 16726.08 |
| 1990-2006 Wrangler, 1990-2001 Cherokee, 1993-1998 Grand Cherokee, Brake Shoes (Rear), 9" x 2.5" With Dana 35 | 16726.06 |
| 1990-2006 Wrangler, 1990-2001 Cherokee, 1993-1998 Grand Cherokee, Brake Shoes (Rear), 9" x 2.5" With Dana 35, Genuine Bendix Brand | 16726.17 |
| 1991-2001 Cherokee, 1993-1998 Grand Cherokee, Brake Shoes (Rear), 10" x 1-3/4" | 16726.14 |
| 1991-2001 Cherokee, 1993-1998 Grand Cherokee, Brake Shoes (Rear), 10" x 1-3/4", Genuine Bendix Brand UPGRADE | 16726.18 |
| 2002 Liberty, Brake Shoes (Rear), 10" x 1-3/4" | 16726.15 |

| Z-3. Brake Shoe Hold Down Kits | Part# |
|--|----------|
| 1953-1967 CJ3B, 1952-1971 M38A1, 1955-1965 CJ5, 1955-1965 CJ6, Brake Shoe Hold Down Kit, With 9" Drums | 16750.03 |
| 1972-1977 CJ5, 1972-1977 CJ6, 1976-1977 CJ7, Brake Shoe Hold Down Kits, For 11" x 2", Fits Front or Rear | 16738.01 |
| 1978-1983 CJ5, 1978-1986 CJ7, 1981-1986 CJ8, 1993-1998 Grand Cherokee, Brake Shoe Hold Down Kits, With 10" Brakes, Front or Rear | 16738.02 |
| 1984-1989 Cherokee, 1987-1989 Wrangler, Brake Shoe Hold Down Kits, With 10" Brakes, Front or Rear | 16738.02 |
| 1990-2000 Wrangler, 1990-2001 Cherokee, 1993-1998 Grand Cherokee, Brake Shoe Hold Down Kits, With 10" Brakes, Front or Rear | 16738.03 |

* CJ2A Before Serial 215469 + CJ2A After Serial 215469 • TJ Before 3/9/00

Brake Components

[Z-4] 16739.01



[Z-6] 16752.02



[Z-6] 16750.01



[Z-5] 16750.13

[Z-7] 16752.24



OMIX-ADA, Inc.

Z-4. Drum Brake Self Adjusting Hardware Kits

Part#

| | |
|---|----------|
| 1978-1983 CJ5, 1979-1986 CJ7, 1981-1986 CJ8, Drum Brake Self Adjusting Screw w 9" Brakes NEW | 16752.24 |
| 1972-1977 CJ5, 1972-1977 CJ6, 1976-1977 CJ7, Drum Brake Self Adjusting Hardware Kits, For 11" x 2", Fits Front or Rear, LH | 16739.01 |
| 1972-1977 CJ5, 1972-1977 CJ6, 1976-1977 CJ7, Drum Brake Self Adjusting Hardware Kits, For 11" x 2", Fits Front or Rear, RH | 16739.02 |
| 1978-1983 CJ5, 1978-1986 CJ7, 1981-1986 CJ8, 1984-2001 Cherokee, 1993-1998 Grand Cherokee, 2000-2006 Wrangler, Drum Brake Self Adjusting Hardware Kit, With 10" Brakes, Front or Rear, LH | 16739.03 |
| 1978-1983 CJ5, 1978-1986 CJ7, 1981-1986 CJ8, 1984-2001 Cherokee, 1993-1998 Grand Cherokee, 2000-2006 Wrangler, Drum Brake Self Adjusting Hardware Kit, With 10" Brakes, Front or Rear, RH | 16739.04 |
| 1990-2000 Wrangler, 1990-2001 Cherokee, 1993-1998 Grand Cherokee, Drum Brake Self Adjusting Hardware Kit, With 9" Brakes, LH | 16739.05 |
| 1990-2000 Wrangler, 1990-2001 Cherokee, 1993-1998 Grand Cherokee, Drum Brake Self Adjusting Hardware Kit, With 9" Brakes, RH | 16739.06 |

[Z-4] 16739.02



Z-5. Brake Shoe Return Springs

Part#

| | |
|--|----------|
| 1941-1945 MB [Front & Rear], 1945-1945 Ford GPW [Front & Rear], 1945-1949 CJ2A, 1948-1953 CJ3A, 1950-1952 M38, Upper Brake Shoe Return Spring [Front or Rear], 2 Required Per Drum | 16750.13 |
| 1953-1967 CJ3B, 1952-1971 M38A1, 1955-1965 CJ5, 1955-1965 CJ6, Brake Show Return Spring [Lower] | 16750.14 |
| 1978-1983 CJ5, 1978-1986 CJ7, 1981-1986 CJ8, 1984-2001 Cherokee, 1993-1998 Grand Cherokee, 2000-2006 Wrangler, Brake Shoe Return Spring, With 10" Brakes | 16752.04 |
| 1990-2000 Wrangler, 1990-2001 Cherokee, 1993-1998 Grand Cherokee, Brake Shoe Return Spring, With 9" Brakes | 16752.14 |

Z-6. Brake Hold Down Hardware

Part#

| | |
|---|----------|
| 1941-1945 MB [Front & Rear], 1945-1945 Ford GPW [Front & Rear], 1945-1949 CJ2A, 1948-1953 CJ3A, 1950-1952 M38, Brake Show Adjusting Anchor Cam [Front or Rear], 2 Required Per Drum | 16750.01 |
| 1941-1945 MB [Front & Rear], 1945-1945 Ford GPW [Front & Rear], 1945-1949 CJ2A, 1948-1953 CJ3A, 1950-1952 M38, Brake Show Adjusting Anchor Pin [Front or Rear], 2 Required Per Drum | 16750.02 |
| 1978-1983 CJ5, 1978-1986 CJ7, 1981-1986 CJ8, 1984-2001 Cherokee, 1993-1998 Grand Cherokee, 2000-2006 Wrangler, Brake, Shoe Retaining Plate, With 10" Brakes, Front or Rear, RH | 16751.01 |
| 1982-1983 CJ5, 1982-1986 CJ7, 1982-1986 CJ8, 1987-1989 Wrangler, Brake Shoe Hold Down Cups | 16752.01 |
| 1982-1983 CJ5, 1982-1986 CJ7, 1982-1986 CJ8, Brake Shoe Equalizer Spring | 16752.03 |
| 1982-1983 CJ5, 1982-1986 CJ7, 1982-1986 CJ8, 1987-1989 Wrangler, Brake Shoe Hold Down Spring | 16752.02 |
| 1990-2000 Wrangler, 1990-2001 Cherokee, 1993-1998 Grand Cherokee, Brake Shoe Hold Down Spring, With 9" Drums | 16752.12 |
| 1990-2000 Wrangler, 1990-2001 Cherokee, 1993-1998 Grand Cherokee, Brake Shoe Equalizer Spring, With 9" Drums | 16752.20 |

Z-7. Drum Brake Self Adjusting Hardware

Part#

| | |
|---|----------|
| 1978-1983 CJ5, 1978-1986 CJ7, 1981-1986 CJ8, Drum Brake Self Adjusting Screw, With 9" Brakes NEW | 16752.24 |
| 1978-1983 CJ5, 1978-1986 CJ7, 1981-1986 CJ8, 1984-2001 Cherokee, 1993-1998 Grand Cherokee, 2000-2006 Wrangler, Brake, Wheel Cylinder Link, With 10" Brakes, Front or Rear, RH | 16751.02 |
| 1982-1983 CJ5, 1982-1986 CJ7, 1982-1986 CJ8, 1984-1989 Cherokee, 1987-1989 Wrangler, Drum Brake Self Adjusting Screw, LH | 16752.09 |
| 1982-1983 CJ5, 1982-1986 CJ7, 1982-1986 CJ8, 1984-1989 Cherokee, 1987-1989 Wrangler, Drum Brake Self Adjusting Screw, RH | 16752.10 |
| 1982-1983 CJ5, 1982-1986 CJ7, 1982-1986 CJ8, 1984-1989 Cherokee, 1987-1989 Wrangler, Brake Shoe Hold Down Spring, LH | 16752.05 |
| 1982-1983 CJ5, 1982-1986 CJ7, 1982-1986 CJ8, 1984-1989 Cherokee, 1987-1989 Wrangler, Drum Brake Self Adjusting Lever, LH or RH | 16752.06 |
| 1982-1983 CJ5, 1982-1986 CJ7, 1982-1986 CJ8, 1984-1989 Cherokee, 1987-1989 Wrangler, Brake Drum Adjuster Spring, LH or RH | 16752.11 |
| 1982-1983 CJ5, 1982-1986 CJ7, 1982-1986 CJ8, 1984-1989 Cherokee, 1987-1989 Wrangler, Drum Brake Self Adjusting Cable Guide, LH or RH | 16752.08 |
| 1982-1983 CJ5, 1982-1986 CJ7, 1982-1986 CJ8, 1984-1989 Cherokee, 1987-1989 Wrangler, Drum Brake Self Adjusting Cable, LH or RH | 16752.07 |
| 1990-2000 Wrangler, 1990-2001 Cherokee, 1993-1998 Grand Cherokee, Drum Brake Self Adjusting Screw, With 9" Brakes, LH | 16752.16 |
| 1990-2000 Wrangler, 1990-2001 Cherokee, 1993-1998 Grand Cherokee, Drum Brake Self Adjusting Screw, With 9" Brakes, RH * | 16752.15 |
| 1990-2000 Wrangler, 1990-2001 Cherokee, 1993-1998 Grand Cherokee, Drum Brake Self Adjusting Lever, With 9" Brakes, LH or RH * | 16752.18 |
| 1990-2000 Wrangler, 1990-2001 Cherokee, 1993-1998 Grand Cherokee, Drum Brake Self Adjusting Cable Guide, With 9" Brakes, LH or RH * | 16752.13 |
| 1990-2000 Wrangler, 1990-2001 Cherokee, 1993-1998 Grand Cherokee, Drum Brake Self Adjusting Cable, With 9" Brakes, LH or RH * | 16752.17 |
| 1990-2000 Wrangler, 1990-2001 Cherokee, 1993-1998 Grand Cherokee, Brake Drum Adjuster Spring, With 9" Brakes, LH or RH | 16752.19 |
| 1991-2001 Cherokee, 1993-1998 Grand Cherokee, Drum Brake Self Adjusting Lever, With 10" Brakes, LH | 16752.23 |
| 1991-2001 Cherokee, 1993-1998 Grand Cherokee, Drum Brake Self Adjusting Lever, With 10" Brakes, RH | 16752.22 |
| 1991-2001 Cherokee, 1993-1998 Grand Cherokee, Drum Brake Self Adjusting Cable, With 10" Brakes, LH or RH | 16752.21 |

* TJ Before 3/9/00



OMIX-ADA, Inc.



[Z-9] 16704.01



[Z-11] 16702.03



[Z10] 11212.01



[Z-12] 16703.01



[Z-8] 16760.07

Z-8. Disc Brake Kits

Kits Include: Rotors, Pad & Caliper Hardware Kit

| | Part# |
|---|----------|
| 1976-1978 CJ5, 1976-1978 CJ7, Disc Brake Rebuild Kit (Front), For 6-Bolt Calipers NEW | 16760.07 |
| 1978-1981 CJ5, 1978-1981 CJ7, 1981 CJ8, Disc Brake Rebuild Kit (Front), For 2-Bolt Calipers NEW | 16760.06 |
| 1982-1983 CJ5, 1982-1986 CJ7, 1982-1986 CJ8, Disc Brake Rebuild Kit (Front) NEW | 16760.05 |
| 1987-1989 Wrangler, 1984-1989 Cherokee (4WD), Disc Brake Rebuild Kit (Front) NEW | 16760.03 |
| 1990-1999 Wrangler, 1990-1999 Cherokee (4WD), 1993-1998 Grand Cherokee, Disc Brake Rebuild Kit (Front) NEW | 16760.02 |
| 1999-2002 Grand Cherokee, Disc Brake Rebuild Kit (Front) NEW | 16760.04 |
| 2000-2006 Wrangler, 2000-2001 Cherokee, Disc Brake Rebuild Kit (Front) NEW | 16760.01 |

Z-9. Rotor & Hub Assemblies

| | Part# |
|--|----------|
| 1976-1978 CJ5, 1976-1978 CJ7, Disc Brake Rotor & Hub Kit (Front), Unassembled (For 6-Bolt Calipers) | 16704.01 |
| 1978-1981 CJ5, 1978-1981 CJ7, 1981 CJ8, Disc Brake Rotor & Hub Kit (Front), Unassembled (For 2-Bolt Calipers with 6 Bolt Hub) | 16704.03 |
| 1978-1981 CJ5, 1978-1981 CJ7, 1981 CJ8, Disc Brake Rotor & Hub Assembly (Front), (For 2-Bolt Calipers with 6 Bolt Hub) | 16704.02 |
| 1981-1983 CJ5, 1981-1986 CJ7, 1981-1986 CJ8, Disc Brake Rotor & Hub Kit (Front), Unassembled (For 2-Bolt Calipers with 5 Bolt Hub) | 16704.04 |
| 1981-1983 CJ5, 1981-1986 CJ7, 1981-1986 CJ8, Disc Brake Rotor & Hub Assembly (Front), (For 2-Bolt Calipers with 5 Bolt Hub) | 16704.05 |

Z-10. Disc Brake Rotor Splash Shields

| | Part# |
|--|----------|
| 1976-1978 CJ5, 1976-1978 CJ7, Disc Brake Rotor Splash Shields (Front), For 6-Bolt Calipers, Black Powder Coated UPGRADE | 11212.01 |
| 1976-1978 CJ5, 1976-1978 CJ7, Disc Brake Rotor Splash Shields (Front), For 6-Bolt Calipers, Stainless Steel UPGRADE | 11121.01 |
| 1978-1983 CJ5, 1978-1986 CJ7, 1981-1986 CJ8, Disc Brake Rotor (Front), For 2-Bolt Calipers, Black Powder Coated UPGRADE | 11212.02 |
| 1978-1983 CJ5, 1978-1986 CJ7, 1981-1986 CJ8, Disc Brake Rotor (Front), For 2-Bolt Calipers, Stainless Steel UPGRADE | 11121.02 |

Z-11. Disc Brake Rotors - Front

| | Part# |
|---|----------|
| 1974-1991 Cherokee / Grand Wagoneer, Disc Brake Rotor (Front) | 16702.06 |
| 1976-1978 CJ5, 1976-1978 CJ7, Disc Brake Rotor (Front), For 6-Bolt Calipers | 16702.01 |
| 1978-1981 CJ5, 1978-1981 CJ7, 1981 CJ8, Disc Brake Rotor (Front), For 2-Bolt Calipers | 16702.02 |
| 1984-1989 Cherokee (4WD Only), 1987-1989 Wrangler, Disc Brake Rotor (Front) | 16702.03 |
| 1986-1992 Cherokee (2WD), Disc Brake Rotor (Front) | 16702.07 |
| 1990-1999 Wrangler, 1990-1999 Cherokee (4WD Only), Disc Brake Rotor (Front) | 16702.04 |
| 1999-2004 Grand Cherokee, Disc Brake Rotor (Front) | 16702.08 |
| 2000-2006 Wrangler, 2000-2001 Cherokee, Disc Brake Rotor (Front) | 16702.05 |
| 2002-2007 Liberty, Disc Brake Rotor (Front) | 16702.09 |
| 2005-2010 Grand Cherokee, Disc Brake Rotor (Front) + | 16702.10 |
| 2006-2010 Grand Cherokee SRT8, Disc Brake Rotor (Front) NEW | 16702.11 |
| 2007-2011 Wrangler, Disc Brake Rotor (Front), With Dana 30 NEW | 16702.12 |

Z-12. Disc Brake Rotors - Rear

| | Part# |
|---|----------|
| 1993-1998 Grand Cherokee, Disc Brake Rotor (Rear) | 16703.01 |
| 1999-2004 Grand Cherokee, Disc Brake Rotor (Rear) | 16703.02 |
| 2002-2007 Liberty, 2003-2006 Wrangler, Disc Brake Rotor (Front) | 16703.03 |
| 2005-2010 Grand Cherokee, Disc Brake Rotor (Rear) NEW + | 16703.04 |
| 2007-2011 Wrangler, Disc Brake Rotor (Rear) NEW | 16703.05 |

* TJ Before 3/9/00 + Except SRT8

Brake Components



[Z-13] 16728.01



[Z-14] 16729.06

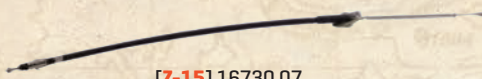

[Z-15] 16730.07



[Z-15] 16730.04

Z-13. Disc Brake Pads - Front

Part#

| | |
|---|----------|
| 1974-1991 Cherokee / Grand Wagoneer, Disc Brake Pads [Front] | 16728.05 |
| 1976-1978 CJ5, 1976-1978 CJ7, Disc Brake Pads [Front], For 6-Bolt Caliper | 16728.01 |
| 1978-1981 CJ5, 1978-1981 CJ7, 1981 CJ8, Disc Brake Pads [Front], For 2-Bolt Calipers | 16728.02 |
| 1978-1981 CJ5, 1978-1981 CJ7, 1981 CJ8, Disc Brake Pads [Front], For 2-Bolt Calipers, Ceramic, Riveted, Genuine Bendix Brand UPGRADE | 16728.11 |
| 1982-1983 CJ5, 1982-1986 CJ7, 1982-1986 CJ8, 1984-1989 Cherokee, 1987-1989 Wrangler, Disc Brake Pads [Front], Semi-Metallic | 16728.03 |
| 1982-1983 CJ5, 1982-1986 CJ7, 1982-1986 CJ8, 1984-1989 Cherokee, 1987-1989 Wrangler, Disc Brake Pads [Front], Titanium | 16728.07 |
| 1982-1983 CJ5, 1982-1986 CJ7, 1982-1986 CJ8, 1984-1989 Cherokee, 1987-1989 Wrangler, Disc Brake Pads [Front], Semi-Metallic, Riveted, Genuine Bendix Brand UPGRADE | 16728.12 |
| 1990-2006 Wrangler, 1990-2001 Cherokee [4WD], 1993-1998 Grand Cherokee, Disc Brake Pads [Front], Semi-Metallic | 16728.04 |
| 1990-2006 Wrangler, 1990-2001 Cherokee [4WD], 1993-1998 Grand Cherokee, Disc Brake Pads [Front], Titanium | 16728.08 |
| 1990-2006 Wrangler, 1990-2001 Cherokee [4WD], 1993-1998 Grand Cherokee, Disc Brake Pads [Front], Semi-Metallic, Genuine Bendix UPGRADE | 16728.14 |
| 1999-2002 Grand Cherokee, Disc Brake Pads [Front], Teves Style, Semi-Metallic | 16728.06 |
| 1999-2002 Grand Cherokee, Disc Brake Pads [Front], Teves Style, Semi-Metallic, Genuine Bendix | 16728.13 |
| 2002-2007 Liberty, Disc Brake Pads [Front] | 16728.09 |
| 2002-2007 Liberty, Disc Brake Pads [Front], Genuine Bendix NEW UPGRADE | 16728.17 |
| 2006-2009 Grand Cherokee [SRT8], Disc Brake Pads [Front] NEW | 16728.16 |
| 2007-2011 Wrangler, Disc Brake Pads [Front] NEW | 16728.15 |

Z-14. Disc Brake Pads - Rear

Part#

| | |
|--|----------|
| 1994 Grand Cherokee, Disc Brake Pads [Rear] Semi-Metallic | 16729.02 |
| 1994 Grand Cherokee, Disc Brake Pads [Rear] Semi-Metallic, Genuine Bendix UPGRADE | 16729.08 |
| 1995-1998 Grand Cherokee, Disc Brake Pads [Rear] Semi-Metallic | 16729.01 |
| 1995-1998 Grand Cherokee, Disc Brake Pads [Rear] Titanium | 16729.05 |
| 1995-1998 Grand Cherokee, Disc Brake Pads [Rear] Semi-Metallic, Genuine Bendix UPGRADE | 16729.08 |
| 1999-2004 Grand Cherokee, Disc Brake Pads [Rear] Titanium | 16729.04 |
| 1999-2004 Grand Cherokee, Disc Brake Pads [Rear] Semi-Metallic, Genuine Bendix UPGRADE | 16729.09 |
| 2003-2006 Wrangler, Disc Brake Pads [Rear] Semi-Metallic | 16729.06 |
| 2003-2006 Wrangler, Disc Brake Pads [Rear] Semi-Metallic, Genuine Bendix UPGRADE | 16729.10 |
| 2003-2007 Liberty, Disc Brake Pads [Rear] Semi-Metallic | 16729.07 |
| 2005-2010 Grand Cherokee, 2006-2009 Commander, Disc Brake Pads [Rear] Semi-Metallic NEW * | 16279.08 |
| 2006-2010 Grand Cherokee SRT8, Disc Brake Pads [Rear] Semi-Metallic NEW | 16279.09 |
| 2008-2011 Wrangler, 2008-2011 Liberty, Disc Brake Pads [Rear], Semi-Metallic NEW | 16279.11 |

Z-15. Emergency Brake Cables

Part#

| | |
|--|----------|
| 1942-1945 MB, 1942-1945 Ford GPW, 1945-1948 CJ2A, Emergency Brake Cable (42.25") * | 16730.01 |
| 1948-1949 CJ2A, 1948-1953 CJ3A, 1953-1967 CJ3B, Emergency Brake Cable (44.5") * | 16730.02 |
| 1952-1964 Truck, Emergency Brake Cable (120") NEW | 16730.14 |
| 1952-1964 Station Wagon, Emergency Brake Cable (120") NEW | 16730.15 |
| 1955-1971 CJ5, Emergency Brake Cable (63-5/8") | 16730.03 |
| 1972-1975 CJ5, Emergency Brake Cable [Front], To Equalizer NEW | 16730.04 |
| 1972-1975 CJ5, Emergency Brake Cable [Rear], LH or RH NEW | 16730.05 |
| 1976-1983 CJ5, Emergency Brake Cable [Front], To Equalizer | 16730.10 |
| 1976-1986 CJ7, Emergency Brake Cable [Front], To Equalizer | 16730.11 |
| 1976-1978 CJ5, 1976-1978 CJ7, Emergency Brake Cable [Rear], With 11" Brakes, Left | 16730.07 |
| 1976-1978 CJ5, 1976-1978 CJ7, Emergency Brake Cable [Rear], With 11" Brakes, Right | 16730.06 |
| 1976-1978 CJ5, 1976-1978 CJ7, Emergency Brake Cable [Rear], With 11" Brakes, Left | 16730.09 |
| 1976-1978 CJ5, 1976-1978 CJ7, Emergency Brake Cable [Rear], With 11" Brakes, Right | 16730.08 |
| 1981-1986 CJ8, Emergency Brake Cable [Front], To Equalizer | 16730.12 |
| 1982-1984 DJ5-M (Postal), Emergency Brake Cable [Rear], LH or RH | 16730.13 |
| 1984-1986 Cherokee, Emergency Brake Cable [Rear], LH or RH | 16730.32 |
| 1987-1990 Wrangler, Emergency Brake Cable [Front], To Equalizer | 16730.17 |
| 1987-1989 Wrangler, Emergency Brake Cable [Rear], Left | 16730.19 |
| 1987-1989 Wrangler, Emergency Brake Cable [Rear], Right | 16730.18 |
| 1987-1989 Cherokee, Emergency Brake Cable [Rear], LH or RH | 16730.27 |
| 1990 Wrangler, Emergency Brake Cable [Rear], Left | 16730.21 |
| 1990 Wrangler, Emergency Brake Cable [Rear], Right | 16730.20 |
| 1990-1991 Cherokee, Emergency Brake Cable [Rear], LH or RH | 16730.28 |
| 1991-1995 Wrangler, Emergency Brake Cable [Front], To Equalizer | 16730.22 |
| 1992-1996 Cherokee, Emergency Brake Cable [Rear], LH or RH | 16730.29 |
| 1991-1995 Wrangler, Emergency Brake Cable [Rear], Left | 16730.25 |
| 1991-1995 Wrangler, Emergency Brake Cable [Rear], Right | 16730.24 |
| 1993-1998 Grand Cherokee, Emergency Brake Cable [Front], To Equalizer | 16730.31 |
| 1993-1998 Grand Cherokee, Emergency Brake Cable [Rear], With Drums Brakes, Left NEW | 16730.49 |
| 1993-1998 Grand Cherokee, Emergency Brake Cable [Rear], With Drums Brakes, Left NEW | 16730.56 |
| 1994-1998 Grand Cherokee, Emergency Brake Cable [Rear], With Disc Brakes, Left NEW | 16730.50 |
| 1994-1998 Grand Cherokee, Emergency Brake Cable [Rear], With Disc Brakes, Left NEW | 16730.51 |
| 1997-2006 Wrangler, Emergency Brake Cable [Front], To Equalizer | 16730.33 |
| 1997-2006 Wrangler, Emergency Brake Cable [Rear], With Rear Drums, Without ABS, LH or RH | 16730.26 |
| 1997-2001 Cherokee, Emergency Brake Cable [Rear], LH or RH | 16730.30 |
| 1999-2004 Grand Cherokee, Emergency Brake Cable [Front], To Equalizer | 16730.34 |
| 1999-2001 Grand Cherokee, Emergency Brake Cable [Rear], Left | 16730.39 |
| 1999-2001 Grand Cherokee, Emergency Brake Cable [Rear], Right | 16730.40 |
| 2002 Liberty, Emergency Brake Cable [Rear], Left | 16730.41 |
| 2002 Liberty, Emergency Brake Cable [Rear], Right | 16730.42 |
| 2003-2006 Wrangler, Emergency Brake Cable [Rear], With Rear Drums, With ABS, LH or RH | 16730.26 |
| 2003-2006 Wrangler, Emergency Brake Cable [Rear] [Rear], With Rear Disc, With ABS, Left | 16730.47 |
| 2003-2006 Wrangler, Emergency Brake Cable [Rear] [Rear], With Rear Disc, With ABS, Right | 16730.48 |
| 2003-2005 Liberty, Emergency Brake Cable [Rear], Left | 16730.45 |
| 2003-2005 Liberty, Emergency Brake Cable [Rear], Right | 16730.46 |
| 2004-2006 Wrangler Unlimited, Emergency Brake Cable [Rear], With Rear Disc, With ABS, Left NEW | 16730.53 |
| 2004-2006 Wrangler Unlimited, Emergency Brake Cable [Rear], With Rear Disc, With ABS, Right NEW | 16730.52 |
| 2005-2009 Grand Cherokee, Emergency Brake Cable [Front], To Equalizer NEW | 16730.35 |
| 2005-2009 Grand Cherokee, Emergency Brake Cable [Rear], LH or RH NEW | 16730.36 |

* Except SRT8 + CJ2A Before Serial #183498 • CJ2A After Serial #183498



OMIX-ADA, Inc.



[Z-16] 16756.01



[Z-20] 16753.03



[Z-20] 16750.12

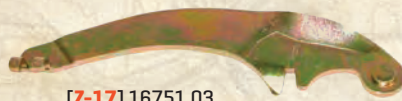

[Z-17] 16751.03



[Z-21] 16750.07



[Z-18] 16755.01



[Z-21] 16750.04



[Z-19] 16731.02



[Z-19] 16731.01

Z-16. Emergency Brake Equalizer

| Part# | Part# |
|---|----------|
| 1976-1983 CJ5, 1976-1986 CJ7, 1981-1986 CJ8, Emergency Brake Equalizer | 16756.01 |
| 1987-1992 Wrangler, 1987-1990 Cherokee, Emergency Brake Equalizer | 16751.14 |
| 1987-1995 Wrangler, Emergency Brake Equalizer Retainer Clip (Front), To Front Cable | 16751.11 |

Z-17. Emergency Brake Levers

| Part# | Part# |
|---|----------|
| 1972-1978 CJ5, 1972-1975 CJ6, 1976-1978 CJ7, Emergency Brake Lever, With 11" Brakes, Left | 16751.03 |
| 1972-1978 CJ5, 1972-1975 CJ6, 1976-1978 CJ7, Emergency Brake Lever, With 11" Brakes, Right | 16751.04 |
| 1978-1983 CJ5, 1978-1986 CJ6, 1978-1986 CJ7, 1987-1989 Wrangler, Emergency Brake Lever Bar, With 10" Brakes, LH or RH | 16751.06 |
| 1972-1978 CJ5, 1972-1975 CJ6, 1976-1978 CJ7, Emergency Brake Lever Bar, With 11" Brakes, LH or RH | 16751.05 |
| 1984-1989 Cherokee, 1987-1989 Wrangler, Emergency Brake Lever, Left | 16751.13 |
| 1984-1989 Cherokee, 1987-1989 Wrangler, Emergency Brake Lever, Right | 16751.12 |

Z-18. Emergency Brake Return Springs

| Part# | Part# |
|--|----------|
| 1941-1945 MB, 1945-1945 Ford GPW, 1945-1949 CJ2A, 1948-1953 CJ3A, 1950-1952 M38, 1952-1971 M38A1, 1953-1967 CJ3B, 1955-1965 CJ5, 1955-1965 CJ6, Emergency Brake Return Spring (Anchor Side) | 16755.01 |
| 1941-1945 MB, 1945-1945 Ford GPW, 1945-1949 CJ2A, 1948-1953 CJ3A, 1950-1952 M38, 1952-1971 M38A1, 1953-1967 CJ3B, 1955-1965 CJ5, 1955-1965 CJ6, Emergency Brake Return Spring (Adjusting Side) | 16755.02 |

Z-19. Emergency Brake Shoes

| Part# | Part# |
|---|----------|
| 1941-1945 MB, 1945-1945 Ford GPW, 1945-1949 CJ2A, 1948-1953 CJ3A, 1950-1952 M38, 1952-1971 M38A1, 1953-1967 CJ3B, 1955-1971 CJ5, 1955-1971 CJ6, Emergency Brake Shoes | 16731.01 |
| 1994 Grand Cherokee, Emergency Brake Shoes NEW * | 16731.07 |
| 1994-1998 Grand Cherokee, Emergency Brake Shoes + | 16731.02 |
| 1999-2004 Grand Cherokee, Emergency Brake Shoes | 16731.05 |
| 2003-2006 Liberty, 2004-2006 Wrangler, Emergency Brake Shoes NEW | 16731.03 |
| 2005-2010 Grand Cherokee, 2005-2010 Commander, Emergency Brake Shoes NEW | 16731.06 |

Z-20. Brake Pedal Pads

| Part# | Part# |
|---|----------|
| 1941-1945 MB, 1945-1945 Ford GPW, Brake Pedal (Steel) | 16750.12 |
| 1945-1949 CJ2A, 1948-1953 CJ3A, 1950-1952 M38, 1952-1971 M38A1, 1953-1967 CJ3B, 1955-1983 CJ5, 1955-1975 CJ6, 1976-1986 CJ7, 1981-1986 CJ8, Brake Pedal / Clutch Pad (With Manual Transmission) | 16753.01 |
| 1972-1983 CJ5, 1972-1975 CJ6, 1976-1986 CJ7, 1981-1986 CJ8, 1987-1995 Wrangler, Emergency Brake Pedal Pad | 16751.07 |
| 1987-2006 Wrangler, 1987-2001 Cherokee, Brake Pedal / Clutch Pad (With Manual Transmission) | 16753.03 |
| 1987-2006 Wrangler, 1987-2001 Cherokee, 1993-1998 Grand Cherokee, Brake Pedal (With Automatic Transmission) | 16753.02 |

Z-21. Brake Pedal Components

| Part# | Part# |
|---|----------|
| 1941-1945 MB, 1945-1945 Ford GPW, 1945-1949 CJ2A, 1948-1953 CJ3A, 1950-1952 M38, 1952-1971 M38A1, 1953-1967 CJ3B, 1955-1965 CJ5, 1955-1965 CJ6, Brake Pedal Arm | 16750.04 |
| 1941-1945 MB, 1945-1945 Ford GPW, 1945-1949 CJ2A, 1948-1953 CJ3A, 1950-1952 M38, 1952-1971 M38A1, 1953-1967 CJ3B, 1955-1965 CJ5, 1955-1965 CJ6, Brake Pedal Return Spring | 16750.06 |
| 1941-1945 MB, 1945-1945 Ford GPW, 1945-1949 CJ2A, 1948-1953 CJ3A, 1950-1952 M38, 1952-1971 M38A1, 1953-1967 CJ3B, 1955-1965 CJ5, 1955-1965 CJ6, Brake / Clutch Pedal Cross Shaft | 16750.07 |
| 1941-1945 MB, 1945-1945 Ford GPW, 1945-1949 CJ2A, 1948-1953 CJ3A, 1950-1952 M38, 1952-1971 M38A1, 1953-1967 CJ3B, 1955-1965 CJ5, 1955-1965 CJ6, Brake / Clutch Pedal Rod Seal Kit (Draft Kit) | 16750.09 |

* Before VIN #358321 + After VIN # 358321



OMIX-ADA, Inc.

Regular Clutch Kit

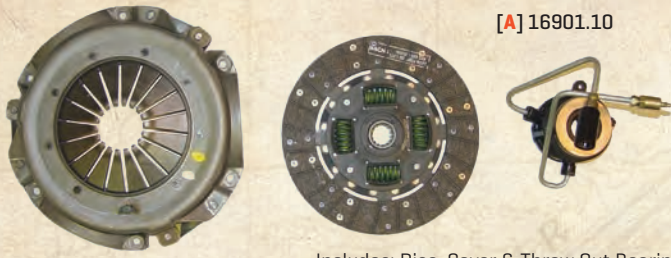

[A] 16901.10

Includes: Disc, Cover & Throw Out Bearing

Master Clutch Kit

Includes: Disc, Cover, Throw Out Bearing, Fork & Pilot Bearing



[B] 16902.03

Junior Clutch Kit

Includes: Disc & Cover



[C] 16903.02



[D] 16904.01

| B. Master Clutch Kits | | Part# |
|---|--|----------|
| 1946-1967 CJ (134 CI L-Head & F-Head), 8 1/2 inch Master Clutch Kit | | 16902.01 |
| 1967-1971 CJ (134 CI F-Head), 9 1/4 inch Master Clutch Kit | | 16902.02 |
| 1972-1975 CJ (3.8L, 4.2L & 5.0L), 11 inch Master Clutch Kit | | 16902.05 |
| 1972-1975 CJ (3.8L, 4.2L & 5.0L), 10.5 inch Master Clutch Kit | | 16902.06 |
| 1976-1979 CJ (3.8L, 4.2L & 5.0L), 10.5 inch Master Clutch Kit (Includes: Cover, Disc, Throw Out Bearing, Fork and Pilot Bearing) | | 16902.07 |
| 1980-1981 CJ (4.2L), 10.5 inch Master Clutch Kit (Includes: Cover, Disc, Throw Out Bearing, Fork and Pilot Bearing) | | 16902.08 |
| 1980-1983 CJ (2.5L GM), Master Clutch Kit (Includes: Cover, Disc, Throw Out Bearing, Fork and Pilot Bearing) | | 16902.03 |
| 1982-1986 CJ (4.2L), 10.5 inch Master Clutch Kit (Includes: Cover, Disc, Throw Out Bearing, Fork and Pilot Bearing) | | 16902.09 |
| 1983-1986 CJ (2.5L AMC), Master Clutch Kit (Includes: Cover, Disc, Throw Out Bearing, Fork and Pilot Bearing) | | 16902.04 |
| 1987-1989 Wrangler Cherokee (4.0L & 4.2L), Peugeot Transmission, Master Clutch Kit (Includes: Cover, Disc, Throw Out Bearing, Fork and Pilot Bearing) | | 16902.15 |
| 1987-1990 Wrangler, Cherokee (2.5L), Master Clutch Kit (Includes: Cover, Disc, Throw Out Bearing, Fork and Pilot Bearing) | | 16902.10 |
| 1989-1991 Wrangler, Cherokee (4.0L), Master Clutch Kit (Includes: Cover, Disc, Throw Out Bearing, Fork and Pilot Bearing) | | 16902.16 |
| 1991-1992 Wrangler, Cherokee (2.5L), Master Clutch Kit (Includes: Cover, Disc, Throw Out Bearing, Fork and Pilot Bearing) | | 16902.11 |
| 1992 Wrangler, Cherokee (4.0L), Master Clutch Kit (Includes: Cover, Disc, Throw Out Bearing, Fork and Pilot Bearing) | | 16902.17 |
| 1993 Wrangler, Cherokee (2.5L), Master Clutch Kit (Includes: Cover, Disc, Throw Out Bearing, Fork and Pilot Bearing) | | 16902.12 |
| 1993 Wrangler, Cherokee (4.0L), Master Clutch Kit (Includes: Cover, Disc, Throw Out Bearing, Fork and Pilot Bearing) | | 16902.18 |
| 1994-2002 Wrangler (2.5L), 1994-2000 Cherokee (2.5L), Master Clutch Kit (Includes: Cover, Disc, Throw Out Bearing, Fork and Pilot Bearing) | | 16902.13 |
| 1994-1999 Wrangler, Cherokee, 1993-1998 Grand Cherokee (4.0L), Master Clutch Kit (Includes: Cover, Disc, Throw Out Bearing, Fork and Pilot Bearing) | | 16902.19 |
| C. Junior Clutch Kits | | Part# |
| 1987-2006 Wrangler, 1994-1997 Cherokee, 1993-1994 Grand Cherokee (4.0L & 4.2L), Junior Clutch Kit (Includes: Cover and Disc Only) | | 16903.03 |
| 1991-2001 Wrangler, 1991-1996 Cherokee (2.5L), Junior Clutch Kit (Includes: Cover and Disc Only) | | 16903.01 |
| 2005-2006 Wrangler (2.4L), 2005 Liberty (2.4L), Junior Clutch Kit (Includes: Cover and Disc Only) | | 16903.07 |
| 1991-1996 Cherokee (2.1L Diesel), Junior Clutch Kit (Includes: Cover and Disc Only) | | 16903.02 |
| 2002-2004 Liberty (2.4L), 2003-2004 Wrangler (2.4L), Junior Clutch Kit (Includes: Cover and Disc) | | 16903.06 |
| 2002-2004 Liberty (3.7L), Junior Clutch Kit (Includes: Cover and Disc) | | 16903.05 |
| D. Clutch Cover | | Part# |
| 1946-1967 CJ (134 CI L-Head & F-Head), 8 1/2 inch Clutch Cover | | 16904.01 |
| 1967-1971 CJ (134 CI F-Head), 9 1/4 inch Clutch Cover | | 16904.02 |
| 1972-1975 and 1980-1983 CJ (3.8L, 4.2L & 5.0L), 11 inch Clutch Cover | | 16904.05 |
| 1972-1981 CJ (3.8L, 4.2L & 5.0L), 10.5 inch Clutch Cover | | 16904.06 |
| 1980-1983 CJ (2.5L GM), Clutch Cover | | 16904.03 |
| 1982-1986 CJ (4.2L), 10.5 inch Clutch Cover | | 16904.07 |
| 1983-1986 CJ (2.5L AMC), Clutch Cover | | 16904.04 |
| 1987-1999 Wrangler and Cherokee, 1993-1998 Grand Cherokee (4.0L & 4.2L), Clutch Cover | | 16904.12 |
| 1987-1990 Wrangler and Cherokee (2.5L), Clutch Cover | | 16904.08 |
| 1991-2002 Wrangler (2.5L), 1991-2000 Cherokee (2.5L), Clutch Cover | | 16904.09 |
| 2002-2006 Wrangler, 2000-2001 Cherokee (4.0L), Clutch Cover | | 16904.13 |
| 2005-2006 Wrangler (2.4L), 2005 Liberty (2.4L), 2007-2011 Wrangler (3.8L), Clutch Cover | | 16904.18 |
| 1991-1996 Cherokee (2.1L) Diesel, Clutch Cover | | 16904.10 |
| 2002-2006 Liberty (3.7L), Clutch Cover | | 16904.14 |
| 2002-2004 Liberty (2.4L), 2003-2004 Wrangler (2.4L), Clutch Cover | | 16904.11 |

| A. Regular Clutch Kits | Part# |
|---|----------|
| 1946-1967 CJ (134 CI L-Head & F-Head), 8 1/2 inch Regular Clutch Kit | 16901.01 |
| 1967-1971 CJ (134 CI F-Head), 9 1/4 inch Regular Clutch Kit | 16901.02 |
| 1972-1975 CJ (3.8L, 4.2L & 5.0L), 11 inch Regular Clutch Kit | 16901.05 |
| 1972-1975 CJ (3.8L, 4.2L & 5.0L), 10.5 inch Regular Clutch Kit | 16901.06 |
| 1976-1979 CJ (3.8L, 4.2L & 5.0L), 10.5 inch Regular Clutch Kit | 16901.07 |
| 1980-1981 CJ (4.2L), 10.5 inch Regular Clutch Kit | 16901.08 |
| 1980-1983 CJ (2.5L GM), Regular Clutch Kit | 16901.03 |
| 1982-1986 CJ (4.2L), 10.5 inch Regular Clutch Kit | 16901.09 |
| 1983-1986 CJ (2.5L AMC), Regular Clutch Kit | 16901.04 |
| 1987-1989 Wrangler (4.2L), Peugeot Transmission, Regular Clutch Kit | 16901.15 |
| 1987-1990 Wrangler, Cherokee (2.5L), Regular Clutch Kit | 16901.10 |
| 1989-1992 Wrangler, Cherokee (4.0L & 4.2L), Regular Clutch Kit | 16901.16 |
| 1991-1992 Wrangler, Cherokee (2.5L), Regular Clutch Kit | 16901.11 |
| 1993 Wrangler, Cherokee (2.5L), Regular Clutch Kit | 16901.12 |
| 1993 Wrangler, Cherokee (4.0L), Regular Clutch Kit | 16901.17 |
| 1994-2002 Wrangler (2.5L), 1994-2000 Cherokee (2.5L), Regular Clutch Kit | 16901.13 |
| 1994-1999 Wrangler, Cherokee, 1993-1998 Grand Cherokee (4.0L), Regular Clutch Kit | 16901.18 |
| 1994-2006 Wrangler, 1994-1997 Cherokee, 1993-1994 Grand Cherokee (4.0L), Regular Clutch Kit | 16901.19 |
| 2002-2004 Liberty (2.4L), 2003-2004 Wrangler (2.4L), Master Clutch Kit | 16901.21 |
| 2002-2004 Liberty (3.7L), Master Clutch Kit | 16901.20 |

| E. Clutch Disc | Part# |
|--|----------|
| 1946-1967 CJ [134 CI L-Head & F-Head], 8 1/2 inch Clutch Disc | 16905.01 |
| 1967-1971 CJ [134 CI F-Head], 9 1/4 inch Clutch Disc | 16905.02 |
| 1972-1975 and 1980-1983 CJ [3.8L, 4.2L & 5.0L], 11 inch Clutch Disc | 16905.05 |
| 1972-1975 and 1980-1986 CJ [3.8L, 4.2L & 5.0L], 1987-1999 Wrangler, Cherokee and Grand Cherokee [4.0L & 4.2L], 10.5 inch Clutch Disc | 16905.06 |
| 1976-1979 CJ [3.8L, 4.2L & 5.0L], 10.5 inch Clutch Disc | 16905.13 |
| 1980-1983 CJ [2.5L GM], Clutch Disc | 16905.03 |
| 1983-1986 CJ [2.5L AMC], 1987-1990 Wrangler and Cherokee [2.5L], Clutch Disc | 16905.04 |
| 1991-2002 Wrangler [2.5L], 1991-2000 Cherokee [2.5L], Clutch Disc | 16905.07 |
| 2002-2006 Wrangler, 2000-2001 Cherokee [4.0L], Clutch Disc | 16905.10 |
| 1991-1996 Cherokee [2.1L] Diesel, Clutch Disc | 16905.08 |
| 2002-2006 Liberty [3.7L], Clutch Disc | 16905.11 |
| 2003-2004 Wrangler, 2002-2004 Liberty [2.4L], Clutch Disc | 16904.15 |

| F. Clutch Bearing | Part# |
|---|----------|
| 1946-1971 CJ [134 CI L-Head & F-Head], 8 1/2 or 9 1/4 inch Clutch Bearing | 16906.01 |
| 1966-1971 CJ [225 CI], Clutch Bearing | 16906.10 |
| 1976-1986 CJ, 1987-1990 Wrangler, 1987-1990 Cherokee [3.8L, 4.0L, 4.2L & 5.0L], Clutch Bearing | 16906.04 |
| 1972-1975 CJ [3.8L, 4.2L & 5.0L], Clutch Bearing | 16906.05 |
| 1980-1983 CJ [2.5L GM], Clutch Bearing | 16906.02 |
| 1983-1986 CJ [2.5L AMC], Clutch Bearing | 16906.03 |
| 1987-1989 Wrangler and Cherokee [4.2L] and Peugeot Transmission, Clutch Bearing | 16909.03 |
| 1990-1992 Wrangler and Cherokee [4.0L & 4.2L] and Aisin Transmission, Clutch Bearing | 16909.05 |
| 1993 Wrangler and Cherokee [2.5L & 4.0L], Clutch Bearing | 16909.06 |
| 1987-1992 Wrangler [2.5L], 1987-1992 Cherokee [2.5L], Clutch Bearing | 16909.04 |
| 1994-2011 Wrangler [2.4L, 2.5L, 3.8L & 4.0L], 1994-2001 Cherokee [2.5L & 4.0L], 2002-2008 Liberty [3.7], Clutch Bearing | 16906.06 |

| G. Clutch Master & Slave Cylinder Kits | Part# |
|--|----------|
| 1994-1995 Wrangler [2.5L & 4.0L], Master and Slave Cylinder Kit | 16907.01 |
| 1997-2004 Wrangler [2.5L & 4.0L], Master and Slave Cylinder Kit | 16907.02 |
| 1997-1999 Wrangler Right Hand Drive, Master and Slave Cylinder Kit | 16907.03 |
| 2001-2001 Wrangler Right Hand Drive, Master and Slave Cylinder Kit | 16907.04 |
| 1994-1996 Cherokee [2.5L & 4.0L], Master and Slave Cylinder Kit | 16907.05 |
| 1994-1996 Cherokee [2.5L & 4.0L] Right Hand Drive, Master and Slave Cylinder Kit | 16907.06 |
| 1998-1999 Cherokee [2.5L & 4.0L], Master and Slave Cylinder Kit | 16907.08 |
| 2000-2001 Cherokee [2.5L & 4.0L], Master and Slave Cylinder Kit | 16907.09 |
| 1997-2001 Cherokee Right Hand Drive, Diesel, Master and Slave Cylinder Kit | 16907.10 |
| 2000-2001 Cherokee [2.5L & 4.0L] Right Hand Drive, Master and Slave Cylinder Kit | 16907.11 |
| 1993-1998 Grand Cherokee [4.0L, 5.2L & 5.9L], Master and Slave Cylinder Kit | 16907.12 |

| H. Clutch Master Cylinders | Part# |
|---|----------|
| 1980-1986 CJ [4.2L], Clutch Master Cylinder | 16908.01 |
| 1987-1990 Wrangler [2.5L & 4.2L], Clutch Master Cylinder | 16908.02 |
| 1991-1995 Wrangler [2.5L & 4.0L], Clutch Master Cylinder | 16908.03 |
| 1994-1996 Wrangler [2.5L & 4.0L], Clutch Master Cylinder | 16908.04 |
| 1997-2004 Wrangler, 1997-2001 Cherokee, Clutch Master Cylinder | 16908.11 |
| 1984-1985 Cherokee [2.5L], 1984 Cherokee [2.8L], Clutch Master Cylinder | 16908.05 |
| 1986 Cherokee [2.5L], 1985-1986 Cherokee [2.8L & 2.1L Diesel], Clutch Master Cylinder | 16908.06 |
| 1987-1990 Cherokee [2.5L, 4.0L & 2.1L Diesel], Clutch Master Cylinder | 16908.07 |
| 1991-1993 Cherokee, Clutch Master Cylinder | 16908.08 |
| 1994-1996 Cherokee, Clutch Master Cylinder | 16908.09 |
| 1993-1996 Grand Cherokee, Clutch Master Cylinder | 16908.10 |

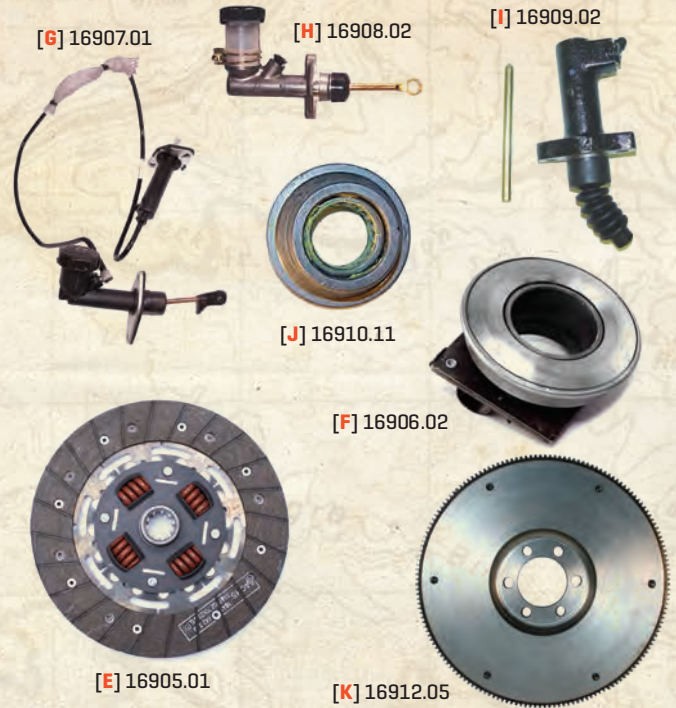

| I. Clutch Slave Cylinders | Part# |
|--|----------|
| 1976-1983 CJ [2.5L GM & 2.4L Diesel], 1980-1986 CJ [4.2L], 1984-1996 Cherokee [2.1L Diesel], Clutch Slave Cylinder | 16909.01 |
| 1983-1986 CJ AMC 150, 1984-1986 Cherokee [2.5L, 4.0L & 4.2L], Clutch Slave Cylinder | 16909.02 |
| 1987-1992 Wrangler and Cherokee [2.5L], Clutch Slave Cylinder | 16909.04 |
| 1987-1989 Wrangler and Cherokee [4.0L & 4.2L] with Peugeot Transmission, Clutch Slave Cylinder | 16909.03 |
| 1989-1992 Wrangler and Cherokee [4.0L & 4.2L] with Aisin Transmission, Clutch Slave Cylinder | 16909.05 |
| 1993 Wrangler and Cherokee [2.5L & 4.0L], Clutch Slave Cylinder | 16909.06 |
| 1994-1999 Wrangler and Cherokee, 1994-1998 Grand Cherokee, Clutch Slave Cylinder | 16909.07 |
| 1997-2001 Wrangler Right Hand Drive, Clutch Slave Cylinder | 16909.08 |

| J. Pilot Bushings & Bearing | Part# |
|---|----------|
| 1941-1971 CJ [134 CI L-Head & F-Head], Pilot Bushing | 16910.01 |
| 1965-1971 CJ [225 CI], Pilot Bushing | 16910.09 |
| 1980-1983 CJ [2.5L GM], Pilot Bearing | 16910.02 |
| 1983-1986 CJ [2.5L AMC], 1987-1999 Wrangler and Cherokee [2.5L], Pilot Bearing | 16910.03 |
| 1972-1975 CJ [3.8L, 4.2L & 5.0L], Pilot Bearing | 16910.04 |
| 1976-1979 CJ [3.8L, 4.2L & 5.0L], Pilot Bearing | 16910.05 |
| 1982-1986 CJ [4.2L], Pilot Bushing | 16910.06 |
| 1987-1991 Wrangler [4.2L], Pilot Bearing | 16910.07 |
| 1992-2000 Wrangler and Cherokee, 1993-1998 Grand Cherokee [4.0L], Pilot Bearing | 16910.08 |
| 2003-2004 Wrangler, 2002-2004 Liberty [2.4L], Pilot Bearing | 16910.11 |
| 2001-2006 Wrangler [4.0L], 2000-2002 Wrangler [2.5L], 2002-2007 Liberty [3.7L], Pilot Bearing | 16910.12 |
| 1993-1998 Grand Cherokee [5.2L & 5.9L] with Manual Transmission, Pilot Bearing | 16910.10 |

| K. Flywheels | Part# |
|--|----------|
| 1991-2002 2.5L, Manual Transmission Flywheel | 16912.02 |
| 1972-1979 [3.8L & 4.2L], Manual Transmission Flywheel | 16912.03 |
| 1982-1987 4.2L CJ and Wrangler, Manual Transmission Flywheel | 16912.05 |
| 1988-1990 4.2L Wrangler, Manual Transmission Flywheel | 16912.06 |
| 1991-1999 4.0L Wrangler and Cherokee, Manual Transmission Flywheel | 16912.07 |
| 1972-1997 AMC V8 360, Manual Transmission Flywheel | 16912.08 |
| 1972-1979 AMC V8 401, Manual Transmission Flywheel | 16912.09 |
| 1972-1986 CJ with GM V8 Conversion, Manual Transmission Flywheel [168 Teeth] | 16912.10 |



OMIX-ADA, Inc.



[L] 16911.02



[N] 16916.01



[S] 16920.15



[T] 16920.04



[M] 16913.05



[Q] 16953.01



[V] 16920.03

[R] 16920.01

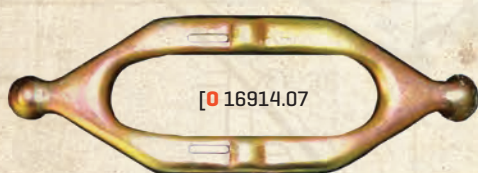

[O] 16914.07



[P] 16918.01



[R] 16920.18

L. Flywheel Ring Gears

| Part# | Part# |
|---|----------|
| 1941-1949 MB and CJ2A with 134, Flywheel Ring Gear | 16911.01 |
| 1953-1971 CJ with 134, Flywheel Ring Gear | 16911.02 |
| 1983-1986 CJ, 1997-2002 Wrangler, 1984-1996 Cherokee (2.5L AMC), Flywheel Ring Gear | 16911.03 |
| 1967-1971 CJ V6 225, Flywheel Ring Gear | 16911.04 |
| 1695-1971 SJ (4.2L), Flywheel Ring Gear | 16911.05 |
| 1972-1986 CJ, 1987-06 Wrangler, 1987-1998 Grand Cherokee (3.8L, 4.0L & 4.2L), 1972-1981 CJ and SJ (5.0L & 5.9L), Flywheel Ring Gear | 16911.06 |

M. Flexplates

| Part# | Part# |
|---|----------|
| 1976-1979 CJ (4.2L), Automatic Transmission Flex Plate | 16913.01 |
| 1976-1979 CJ 304 V8, Automatic Transmission Flex Plate | 16913.02 |
| 1976-1979 CJ 360 V8, Automatic Transmission Flex Plate | 16913.03 |
| 1976-1979 CJ 401 V8, Automatic Transmission Flex Plate | 16913.04 |
| 1980-1986 CJ 258 (4.2L), Automatic Transmission Flex Plate | 16913.05 |
| 1980-1986 CJ and SJ 304 and 360 V8, Automatic Transmission Flex Plate | 16913.06 |
| 1972-1974 DJ Postal Jeeps, Automatic Transmission Flex Plate | 16913.07 |
| 1972-1986 CJ with GM V8 Conversion, Automatic Transmission Flex Plate | 16913.08 |
| 1987-1990 Cherokee 4.0L, Automatic Transmission Flex Plate | 16913.11 |
| 1991-2000 Cherokee 4.0L, Automatic Transmission Flex Plate | 16913.10 |

N. Bellhousings & Components

| Part# | Part# |
|--|----------|
| 1976-1986 CJ (3.8L, 4.2L & 5.0L) and T150 or T176, Bellhousing | 16916.01 |
| 1980-1986 CJ with SR4, T4, T5, Bellhousing | 16916.02 |
| 1974-1986 CJ (3.8L, 4.2L & 5.0L), Clutch Housing Cover | 16917.01 |
| 1974-1986 CJ (3.8L, 4.2L & 5.0L), Clutch Engine Spacer | 16917.02 |

O. Clutch Forks

| Part# | Part# |
|---|----------|
| 1941-1945 MB, 1950-1952 M38, M38A1, 1945-1971 CJ with 4 Cylinder 134, Clutch Fork | 16914.01 |
| 1946-1953 Station Wagon, 1946-1953 Truck, 1948-1951 Jeepster, Clutch Fork | 16914.02 |
| 1980-1983 CJ (2.5L GM), Clutch Fork | 16914.03 |
| 1972-1975 CJ (3.8L, 4.2L & 5.0L), Clutch Fork | 16914.05 |
| 1976-1986 CJ (3.8L, 4.2L & 5.0L), Clutch Fork | 16914.06 |
| 1994-2011 Wrangler, 1994-1999 Cherokee (2.5L & 4.0L), 1994-1998 Grand Cherokee (4.0L, 5.2L & 5.9L), 2002-2007 Liberty (3.7L), Clutch Fork | 16914.07 |

P. Clutch Fork Boots

| Part# | Part# |
|---|----------|
| 1972-1975 CJ (3.8L, 4.2L & 5.0L), Clutch Boot | 16918.01 |
| 1976-1979 CJ (3.8L, 4.2L & 5.0L), Clutch Boot | 16918.02 |
| 1980-1986 CJ (4.2L & 5.0L), Clutch Boot | 16918.03 |

Q. Clutch Pedal Covers

| Part# | Part# |
|---|----------|
| 1946-1986 CJ Clutch Pedal Cover | 16953.01 |
| 1972-1986 CJ Clutch Pedal Cover | 16753.01 |
| 1987-2006 Wrangler, 1987-2001 Cherokee Clutch Pedal Cover | 16753.03 |

R. 1941-1971 CJ Clutch Pedal

| Part# | Part# |
|---|----------|
| 1941-1971 CJ, Clutch Pedal | 16920.01 |
| 1941-1971 CJ, Clutch Pedal Return Spring | 16750.06 |
| 1941-1971 CJ, Pedal Draft Pad Kit | 16750.09 |
| 1941-45MB, 1941-1945 Ford GPW, Clutch Pedal | 16920.18 |

S. 1941-1971 Clutch Rods

| Part# | Part# |
|--|----------|
| 1941-1945 MB, Clutch Rod | 16920.14 |
| 1946-1971 CJ 134 "L" or "F" Head Motor, Clutch Rod | 16920.15 |

T. 1941-1971 CJ Idler Cross Shaft

| Part# | Part# |
|---------------------------------------|----------|
| 1941-1971 CJ Cross Shaft | 16920.04 |
| 1941-1971 CJ Cross Shaft Hold Bracket | 16920.07 |
| 1941-1971 CJ Idler Cross Shaft Felt | 16920.08 |
| 1941-1971 CJ Idler Cross Shaft Plate | 16920.09 |
| 1941-1971 CJ Idler Cross Shaft Spring | 16920.10 |
| 1941-1971 CJ Idler Cross Shaft Boot | 16920.11 |

U. 1941-1971 CJ Clutch Bellcrank

| Part# | Part# |
|--|----------|
| 1941-1945 MB, Bellcrank Kit | 16920.05 |
| 1946-1971 CJ (134 CI), Bellcrank Kit | 16920.06 |
| 1941-1945 MB, Clutch Cable (9.25 inch) | 16920.12 |
| 1946-1971 CJ (134 CI), Clutch Cable (Bellcrank to Clutch Fork) | 16920.13 |

V. 1941-1971 CJ Misc Clutch

| Part# | Part# |
|--|----------|
| 1946-1971 CJ (134 CI), Clutch Linkage (Clutch to Spring) | 16920.03 |
| 1946-1971 CJ (134 CI), Clutch Linkage Yoke | 16920.16 |

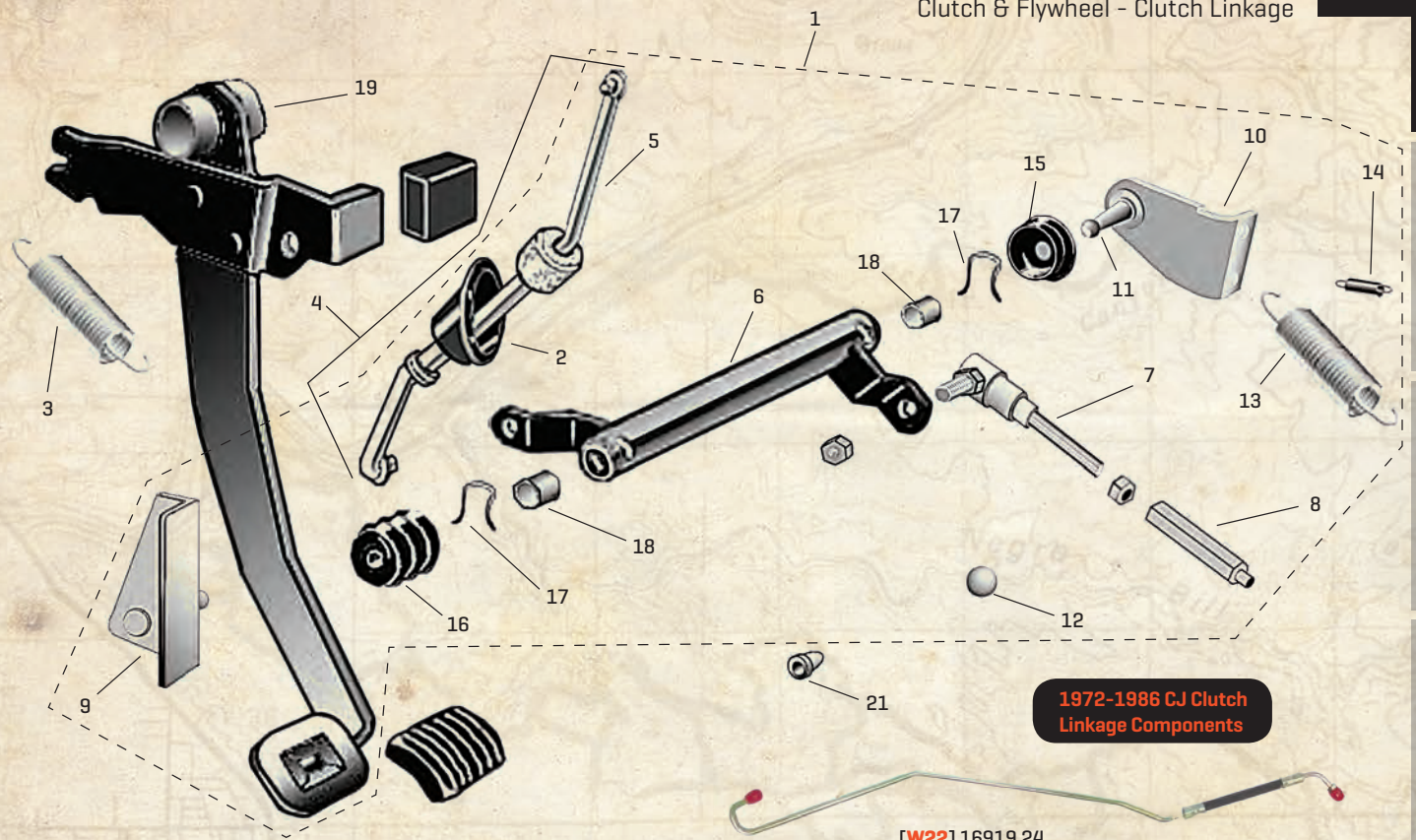

1972-1986 CJ Clutch Linkage Components

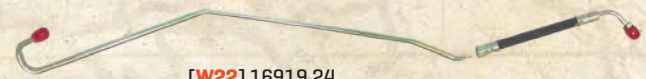

[W22] 16919.24



[W1] 16919.01



[W20] 16919.22



[W23] 16919.25



[W4] 16919.04



[W24] 16919.30

| W. 1972-1986 CJ Clutch Linkage | | Part# |
|--------------------------------|---|----------|
| 1 | 1976-1983 CJ5, 1976-1986 CJ7, 1981-1986 CJ8 Bellcrank Kits (Includes: 2, 5, 6, 7, 8, 9, 10, 11, 12, 13, 14, 15, 16, and 2 of 17 & 18) | 16919.01 |
| 2 | 1972-1983 CJ5, 1972-1975 CJ6, 1976-1986 CJ7, 1981-1986 CJ8 Clutch Linkage Rod Boot | 16919.02 |
| 3 | 1972-1983 CJ5, 1972-1975 CJ6, 1976-1986 CJ7, 1981-1986 CJ8 Clutch Pedal Return Spring | 16919.03 |
| 4 | 1972-1975 CJ5, 1972-1975 CJ6 or 8 Cylinder Clutch Rod Assembly | 16919.04 |
| 5 | 1976-1983 CJ5, 1976-1986 CJ7, 1981-1986 CJ8 Pedal to Bellcrank Rod | 16919.05 |
| 6 | 1972-1975 CJ5, 1972-1975 CJ6 Bellcrank | 16919.06 |
| 6 | 1976-1983 CJ5, 1976-1986 CJ7, 1981-1986 CJ8 Bellcrank | 16919.07 |
| 7 | 1972-1983 CJ5, 1972-1975 CJ6, 1976-1986 CJ7, 1981-1986 CJ8 Lower Clutch Rod | 16919.08 |
| 8 | 1972-1983 CJ5, 1972-1975 CJ6, 1976-1986 CJ7, 1981-1986 CJ8 Clutch Rod Adjuster | 16919.09 |
| 9 | 1976-1983 CJ5, 1976-1986 CJ7, 1981-1986 CJ8 Body Bracket with Pivot Stud | 16919.10 |
| 10 | 1976-1983 CJ5, 1976-1986 CJ7, 1981-1986 CJ8 Bellhousing Bracket with Stud | 16919.11 |
| 11 | 1972-1975 CJ5, 1972-1975 CJ6 Bellcrank Pivot Stud | 16919.12 |
| 12 | 1972-1983 CJ5, 1972-1975 CJ6, 1976-1986 CJ7, 1981-1986 CJ8 Clutch Fork Pivot Ball | 16919.13 |
| 13 | 1972-1983 CJ5, 1972-1975 CJ6, 1976-1986 CJ7, 1981-1986 CJ8 Clutch Fork Return Outer Spring | 16919.14 |
| 14 | 1972-1975 CJ5, 1972-1975 CJ6 Clutch Fork Return Inner Spring | 16919.15 |
| 14 | 1976-1983 CJ5, 1976-1986 CJ7, 1981-1986 CJ8 6 or 8 Cylinder Clutch Fork Inner Spring | 16919.16 |
| 15 | 1972-1983 CJ5, 1972-1975 CJ6, 1976-1986 CJ7, 1981-1986 CJ8 Bellcrank Inner Boot | 16919.17 |
| 15 | 1972-1983 CJ5, 1972-1975 CJ6, 1976-1986 CJ7, 1981-1986 CJ8 Bellcrank Outer Boot | 16919.18 |
| 16 | 1972-1983 CJ5, 1972-1975 CJ6, 1976-1986 CJ7, 1981-1986 CJ8 Bellcrank Clip [2 Needed] | 16919.19 |
| 17 | 1972-1983 CJ5, 1972-1975 CJ6, 1976-1986 CJ7, 1981-1986 CJ8 Bellcrank Plastic Bushing [2 Needed] | 16919.20 |
| 19 | 1972-1981 [3.8L, 4.2L or 5.0L] Clutch Pedal Bearing [2 Needed] | 16919.21 |
| 20 | 1981-1983 CJ5, 1981-1986 CJ7, 1981-1986 CJ8, 1987-1995 Wrangler Clutch Pedal Bushing | 16919.22 |
| 21 | 1980-1983 CJ5, 1980-1986 CJ7, 1981-1986 CJ8 4 or 6 Cylinder Clutch Slave Plastic Pivot | 16919.23 |
| 22 | 1980-1983 CJ5, 1980-1986 CJ7, 1981-1986 CJ8 Clutch Master Cylinder Hose [Except 2.5L AMC] | 16919.24 |
| 23 | 1980-1983 CJ5, 1980-1986 CJ7, 1981-1986 CJ8 Slave Cylinder Return Spring | 16919.25 |
| 24 | 1976-1983 CJ5, 1976-1986 CJ7, 1981-1986 CJ8, Heavy Duty Clutch Linkage (Up to 3 inch Body Lift) UPGRADE | 16919.30 |

All images are subject to be representative. More detailed information is available online.

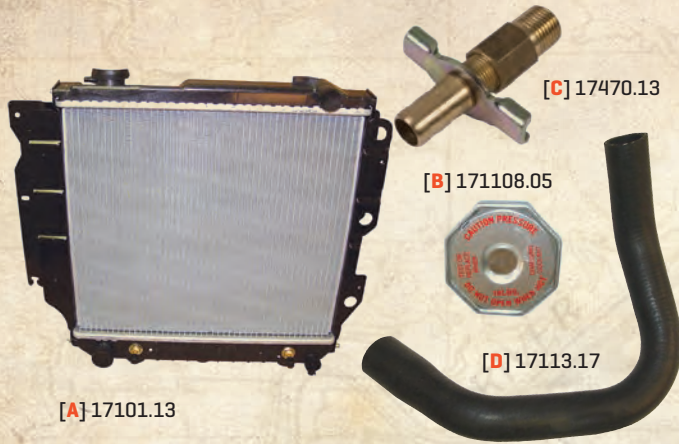

[A] 17101.13

[B] 171108.05

[C] 17470.13

[D] 17113.17

A. Radiators

Part#

| | |
|---|----------|
| 1941-1945 MB, 1941-1945 Ford GPW, CJ2A 1945-1949, M38 1950-1952, Radiator, With Shroud, 2 Row * | 17101.01 |
| 1941-1945 MB, 1941-1945 Ford GPW, CJ2A 1945-1949, M38 1950-1952, Radiator, Without Shroud, 2 Row | 17101.02 |
| 1955-1971 CJ5, 1955-1971 CJ6, Radiator, 2 Row [For 134 CI Engine] | 17101.04 |
| 1972-1983 CJ5, 1972-1975 CJ6, 1976-1986 CJ7, 1981-1986 CJ8, Radiator, 3 Row, With Center Filler [For 4.2L or 5.0L Engine With MT or AT] | 17101.07 |
| 1981-1983 CJ5, 1981-1986 CJ7, 1981-1986 CJ8, Radiator, 2 Row, With LH Offset Filler [For 4.2L Engine With MT or AT] | 17101.10 |
| 1981-1983 CJ5, 1981-1986 CJ7, 1981-1986 CJ8, Radiator, 2 Row, With Center Filler [For 4.2L Engine With MT or AT] | 17101.09 |
| 1972-1983 CJ5, 1972-1975 CJ6, 1976-1986 CJ7, 1981-1986 CJ8, Radiator, 3 Row, With Center Filler [For 5.0L or 5.7L GM Engine Conversion With MT or AT] | 17101.15 |
| 1983-1986 CJ7, 1983-1986 CJ8, Radiator, 2 Row [For 2.5L AMC Engine] | 17101.05 |
| 1983-1984 DJ5-M [Postal], Radiator, 2 Row [For 2.5L AMC Engine] | 17101.06 |
| 1987-1991 Wrangler [2.5L & 4.2L] [MT or AT], 1997-2006 Wrangler [2.4L, 2.5L or 4.0L] [AT], 2004-2006 Wrangler Unlimited [4.0L] [AT], Radiator, 2 Row [With or Without AC] | 17101.13 |
| 1992-1995 Wrangler [2.5L & 4.2L], Radiator, 2 Row [With or Without AC] [MT or AT] | 17101.12 |
| 1987-1995 Wrangler, Radiator, 3 Row, With Center Filler [For 5.0L or 5.7L GM Engine Conversion With MT or AT] | 17101.16 |
| 1997-2006 Wrangler [2.4L, 2.5L & 4.0L] [MT], 2004-2006 Wrangler Unlimited [4.0L] [MT], Radiator, 2 Row [With or Without AC] | 17101.14 |
| 2007-2011 Wrangler [3.8L], 1 Row, Radiator NEW | 17101.38 |
| 1984-1994 Cherokee [2.5L], 1984-1986 Cherokee [2.8L], Radiator, 2 Row, [With or Without AC] [MT or AT] | 17101.17 |
| 1987-1990 Cherokee [4.0L], Radiator, 2 Row, [With or Without AC] [MT or AT] | 17101.18 |
| 1991-2000 Cherokee [4.0L], Radiator, 2 Row, [With or Without AC] [MT or AT] | 17101.21 |
| 1993-1994 Cherokee [RHD] [4.0L], Radiator, 2 Row, [With or Without AC] [AT] | 17101.34 |
| 2001 Cherokee [4.0L], Radiator, 2 Row, [With or Without AC] [MT or AT] | 17101.35 |
| 1993-1997 Grand Cherokee [4.0L], Radiator, 2 Row, [With or Without AC] [MT or AT] | 17101.23 |
| 1993-1997 Grand Cherokee [5.2L & 5.9L], Radiator, 2 Row, [With or Without AC] [MT or AT] | 17101.27 |
| 1998 Grand Cherokee [4.0L], Radiator, 2 Row, [With or Without AC] [MT or AT] | 17101.25 |
| 1998 Grand Cherokee [5.2L & 5.9L], Radiator, 2 Row, [With or Without AC] [MT or AT] | 17101.29 |
| 1999-2004 Grand Cherokee [4.0L], Radiator, 1 Row, [With or Without AC] | 17101.26 |
| 2001-2004 Grand Cherokee [4.7L], Radiator, 1 Row, [With or Without AC] | 17101.31 |
| 2005-2008 Grand Cherokee [3.7L & 4.7L], 2006-2009 Grand Cherokee [6.1L], Radiator, 1 Row NEW | 17101.39 |
| 1999-2000 Grand Cherokee [4.7L], Radiator, 1 Row, [With or Without AC] | 17101.30 |
| 2005-2009 Grand Cherokee [5.7L], Radiator NEW | 17101.40 |
| 2002-2005 Liberty [2.4L], Radiator, 1 Row [With AC] NEW | 17101.37 |
| 2002-2006 Liberty [3.7L], Radiator, 1 Row [With or Without AC] | 17101.36 |
| 1974-1979 Cherokee [SJ] [5.9L & 6.6L], Radiator, 2 Row, [With or Without AC] [MT or AT] | 17101.32 |
| 1980-1991 Cherokee [SJ] [5.9L & 6.6L], Radiator, 2 Row, [With or Without AC] [MT or AT] | 17101.33 |

B. Radiator Caps

Part#

| | |
|---|----------|
| 1941-1945 MB, 1941-1945 GPW, 1945-1949 CJ2A, 1948-1953 CJ3A, 1950-1952 M38, Radiator Cap [4 lbs], [For 134 CI With L-Head] * | 17108.01 |
| 1952-1971 M38A1, 1953-1967 CJ3B, 1955-1971 CJ5, 1955-1971 CJ6, Radiator Cap [7 lbs], [For 134 CI With F-Head] | 17108.08 |
| 1974-1983 CJ5 [3.8L, 4.2L & 5.0L], 1976-1986 CJ7 [3.8L, 4.2L & 5.0L], 1981-1986 CJ8 [4.2L & 5.0L], Radiator Cap [16lbs], 2007-2011 Compass [2.0L & 2.4L], 2007-2011 Patriot [2.0L & 2.4L] | 17108.02 |
| 1984-1990 Cherokee [2.5L], 1984-1986 Cherokee [2.8L], 1991-1993 Cherokee [4.0L], 1987-1993 Wrangler [2.5L, 4.0L & 4.2L], Radiator Cap [16 lbs] | 17108.03 |
| 1991-2000 Cherokee [2.5L], 1994-2001 Cherokee [4.0L], 1994-1995 Wrangler [2.5L & 4.0L], Radiator Cap [16 lbs] | 17108.04 |
| 1993-1998 Grand Cherokee, [4.0L, 5.2L & 5.9L], 1999-2004 Grand Cherokee [4.0L], Wrangler 1997-2006 [2.4L, 2.5L & 4.0L], Radiator Cap [18lbs], 2007-2011 Wrangler [3.8L], 2002-2005 Liberty [2.4L], 2002 Liberty [3.7L], 2006-2010 Commander [3.7L, 4.7L & 5.7L] | 17108.05 |
| 1999-2004 Grand Cherokee [4.7L], Radiator Cap [20 lbs] | 17108.06 |

C. Drain Cocks

Part#

| | |
|--|----------|
| 1941-1945 MB, Gpw, Drain Cock, 1/8" [New] | 17470.13 |
| 1941-1945 MB, 1941-1945 Ford GPW, CJ2A 1945-1949, M38 1950-1952, Drain Cock [1/8"] | 17120.01 |
| 1983-1986 CJ7, 1983-1986 CJ8, 1987-2006 Wrangler, Drain Cock [1/4"] | 17120.01 |

D. Radiator Hoses Upper

Part#

| | |
|---|----------|
| 1941-1945 MB, 1941-1945 GPW, 1945-1949 CJ2A, 1948-1950 CJ3A, Upper Radiator Hose [For 134 CI] | 17113.01 |
| 1949-1953 CJ3A, 1950-1952 M38, 1946-1950 Truck, 1946-1950 Station Wagon, 1948-1950 Jeepster, Upper Radiator Hose [For 134 CI] | 17113.02 |
| 1953-1967 CJ3B, 1950-1953 Truck, 1950-1953 Station Wagon, 1950-1951 Jeepster, Upper Radiator Hose [For 134 CI] | 17113.03 |
| 1955-1971 CJ5, 1955-1971 CJ6, Upper Radiator Hose [For 134 CI Engine] | 17113.04 |
| 1983 CJ5, 1983-1986 CJ7, 1983-1986 CJ8, Upper Radiator Hose [For 2.5L AMC] | 17113.04 |
| 1974-1981 CJ5, 1974-1975 CJ6, 1976-1986 CJ7, 1981-1986 CJ8, Upper Radiator Hose [For 4.2L] | 17113.11 |
| 1980-1983 CJ5, 1980-1983 CJ7, 1981-1983 CJ8, Upper Radiator Hose [For 2.5L GM] | 17113.05 |
| 1972-1981 CJ5, 1972-1975 CJ6, 1976-1981 CJ7, 1981 CJ8, Upper Radiator Hose [For 5.0L] | 17113.18 |
| 1954-1964 Truck and Station Wagon [226 CI], Upper Radiator Hose | 17113.10 |
| 1987-1995 Wrangler [2.5L], Upper Radiator Hose | 17113.07 |
| 1987-1990 Wrangler [4.2L], Upper Radiator Hose | 17113.12 |
| 1991-1995 Wrangler [4.0L], Upper Radiator Hose | 17113.13 |
| 1997-2002 Wrangler [2.5L] Upper Radiator Hose NEW | 17113.20 |
| 1997-2006 Wrangler [4.0L], Upper Radiator Hose | 17113.14 |
| 2003-2006 Wrangler [2.4L], Upper Radiator Hose | 17113.23 |
| 2007-2011 Wrangler [3.8L], Upper Radiator Hose NEW | 17113.27 |
| 1987-1998 Cherokee [2.5L Without AC], Upper Radiator Hose | 17113.08 |
| 1987-1997 Cherokee [2.5L With AC], Upper Radiator Hose | 17113.09 |
| 1987-1998 Cherokee [4.0L Without AC], Upper Radiator Hose | 17113.15 |
| 1987-1990 Cherokee [4.0L With AC], Upper Radiator Hose | 17113.15 |
| 1991-1998 Cherokee [4.0L With AC], Upper Radiator Hose | 17113.16 |
| 1999-2001 Cherokee [4.0L With AC], Upper Radiator Hose | 17113.22 |
| 1993-1998 Grand Cherokee [4.0L], Upper Radiator Hose | 17113.17 |
| 1999-2004 Grand Cherokee [4.0L], Upper Radiator Hose | 17113.21 |
| 1993-1998 Grand Cherokee [5.2L], 1998 Grand Cherokee [5.9L], Upper Radiator Hose | 17113.19 |
| 2005-2010 Grand Cherokee [3.7L], Upper Radiator Hose NEW | 17113.24 |
| 2005-2009 Grand Cherokee [4.7L], Upper Radiator Hose NEW | 17113.25 |
| 2002-2007 Liberty [3.7L], Upper Radiator Hose NEW | 17113.26 |
| 2005-2006 Liberty [2.8L Diesel], Upper Radiator Hose NEW | 17113.28 |

* Requires Use Of Radiator Cap 17108.02, Will Not Work With Cap 17108.01 + For OE Radiator - Use PN 17108.02 For Radiator PN: 17101.01 NOTE: MT = Manual Transmission AT = Automatic Transmission



OMIX-ADA, Inc.



| E. Radiator Hoses Lower | Part# |
|--|----------|
| 1941-1945 MB, 1941-1945 GPW, 1945-1949 CJ2A, 1948-1950 CJ3A, 1950-1952 M38, 1946-1949 Truck, 1946-1949 Station Wagon, 1948-1949 Jeepster, Lower Radiator Hose [For 134 CI] * | 17114.01 |
| 1949-1953 CJ3A, 1952-1971 M38A1, 1953-1967 CJ3B, 1950-1953 Truck, 1950-1953 Station Wagon, 1948-1951 Jeepster, Lower Radiator Hose [For 134 CI] † | 17114.02 |
| 1972-1981 CJ5, 1972-1975 CJ6, 1976-1981 CJ7, 1981 CJ8, Lower Radiator Hose [For 5.0L] | 17114.13 |
| 1974-1981 CJ5, 1974-1975 CJ6, 1976-1986 CJ7, 1981-1986 CJ8, Lower Radiator Hose [For 4.2L] | 17114.08 |
| 1980-1983 CJ5, 1980-1983 CJ7, 1981-1983 CJ8, Lower Radiator Hose [For 2.5L GM] | 17114.03 |
| 1983 CJ5, 1983-1986 CJ7, 1983-1986 CJ8, Lower Radiator Hose [For 2.5L AMC] | 17114.04 |
| 1954-1964 Truck and Station Wagon [226 CI], Lower Radiator Hose | 17114.01 |
| 1987-1995 Wrangler [2.5L], Lower Radiator Hose | 17114.05 |
| 1987-1990 Wrangler [4.2L], Lower Radiator Hose | 17114.09 |
| 1991-2000 Wrangler [4.0L], 1987-1997 Cherokee [2.5L] Lower Radiator Hose | 17114.07 |
| 1997-2002 Wrangler [2.5L], Lower Radiator Hose | 17114.06 |
| 2003-2006 Wrangler [2.4L], Lower Radiator Hose | 17114.19 |
| 2007-2011 Wrangler [3.8L], Lower Radiator Hose NEW | 17114.25 |
| 1987-2001 Cherokee [4.0L], Lower Radiator Hose | 17114.11 |
| 1999-2001 Cherokee [4.0L] (RHD), Lower Radiator Hose | 17114.17 |
| 1991-2000 Wrangler [4.0L], 1987-1997 Cherokee [2.5L] Lower Radiator Hose | 17114.07 |
| 1993-1998 Grand Cherokee [4.0L], Lower Radiator Hose | 17114.12 |
| 1993-1998 Grand Cherokee [5.2L], 1998 Grand Cherokee [5.9L], Lower Radiator Hose | 17114.14 |
| 1999-2004 Grand Cherokee [4.0L], Lower Radiator Hose | 17114.15 |
| 1999-2004 Grand Cherokee [4.7L], Lower Radiator Hose | 17114.16 |
| 2005-2010 Grand Cherokee [3.7L], Lower Radiator Hose NEW | 17114.20 |
| 2005-2009 Grand Cherokee [4.7L], Lower Radiator Hose | 17114.21 |
| 2005-2008 Grand Cherokee [5.7L], 2006-2009 Grand Cherokee [6.1L], Lower Radiator Hose NEW | 17114.22 |
| 2002-2007 Liberty [3.7L], Lower Radiator Hose NEW | 17114.24 |
| 2005-2006 Liberty [2.8L Diesel], Lower Radiator Hose NEW | 17114.26 |

F. Heater Bypass & Other Hoses Part#

| | |
|---|----------|
| 1952-1971 M38A1, 1953-1967 CJ3B, 1955-1971 CJ5, 1955-1971 CJ6, Water Pump Bypass Hose | 17116.02 |
| 1972-1981 CJ5, 1972-1975 CJ6, 1976-1981 CJ7, 1981 CJ8, Bypass Hose | 17116.01 |
| 1988-1990 Cherokee [4.0L], Heater Valve To Core Hose | 17116.63 |
| 1988-1990 Cherokee [4.0L], Heater Valve To Tee Hose | 17116.65 |
| 1988-1990 Cherokee [4.0L], Tee To Water Pump Hose | 17116.62 |
| 1991-1993 Cherokee [4.0L], Heater Core to Valve Hose | 17116.50 |
| 1991-1993 Cherokee [4.0L], Heater Valve To Core Hose | 17116.64 |
| 1987-1990 Wrangler [4.2L], Heater Return Hose | 17116.51 |
| 1987-1990 Wrangler [4.2L], Supply Return Hose | 17116.56 |
| 1997-2002 Wrangler [2.5L], 1997-1997 Wrangler [4.0L], Heater Return Hose | 17116.54 |
| 1999-2004 Grand Cherokee [4.0L], Heater Return Hose | 17116.55 |
| 1991-1993 Cherokee [4.0L], Heater Return Hose | 17116.52 |
| 1997-2001 Cherokee [4.0L], Heater Return Hose | 17116.53 |
| 1993-1998 Grand Cherokee [4.0L & 5.2L] Heater Return Hose | 17116.52 |
| 1993-1998 Grand Cherokee [5.2L] Heater Return Hose | 17116.60 |
| 1997-1997 Wrangler [4.0L], 1999-2004 Grand Cherokee [4.0L], Heater Supply Hose | 17116.61 |
| 1994-1996 Cherokee [4.0L], Heater Supply Hose | 17116.58 |
| 1997-2001 Cherokee [4.0L], Heater Supply Hose | 17116.59 |
| 1995-1996 Grand Cherokee [4.0L], Heater Supply Hose | 17116.57 |

G. Hose Clamps Part#

| | |
|---|----------|
| Universal, Radiator Hose Clamp, Adjustable 1-5/16" to 2-1/4" | 17115.01 |
| 1972-1981 CJ5, 1972-1975 CJ6, 1976-1981 CJ7, 1981 CJ8, Heater Hose Clamp [2 Required] | 17115.02 |

H. Fan Blades Part#

| | |
|---|----------|
| 1991-1995 Wrangler [4.0L], Fan Blade [Asymmetrical 5 Blade] | 17109.02 |
|---|----------|

I. Fan Shroud Part#

| | |
|--|----------|
| 1974-1983 CJ5 [3.8L & 4.2L], 1976-1986 CJ7 [3.8L & 4.2L], 1981-1986 CJ8 [4.2L], Radiator Fan Shroud [Without HD Cooling] | 17102.01 |
| 1974-1981 CJ5 [5.0L], 1976-1981 CJ7 [5.0L], 1981 CJ8 [5.0L], Radiator Fan Shroud [Without HD Cooling] | 17102.03 |
| 1981-1983 CJ5 [3.8L & 4.2L], 1981-1986 CJ7 [3.8L & 4.2L], 1981-1986 CJ8 [4.2L], Radiator Fan Shroud [With HD Cooling] | 17102.02 |
| 1991-1995 Wrangler [4.0L], Radiator Fan Shroud † | 17102.04 |

* For Bottom Mount Radiator † For Side Mount Radiator • Except RHD



[J] 17105.07



[K] 17102.57



[L] 17104.14



[L] 17104.01



[M] 17104.80



OMIX-ADA, Inc.

J. Fan Clutches

Part#

| | |
|--|----------|
| 1974-1983 CJ5 (3.8L, 4.2L & 5.0L), 1976-1986 CJ7 (3.8L, 4.2L & 5.0L), 1981-1986 CJ8 (4.2L & 5.0L), Fan Clutch, (With V-Belt) | 17105.06 |
| 1983-1986 CJ7 (AMC 2.5L), 1981-1986 CJ8 (4.2L), 1987-1990 Wrangler (2.5L & 4.2L), 1984-1986 Cherokee (2.5L) Fan Clutch, (With V-Belt) | 17105.01 |
| 1974-1983 CJ5 (3.8L, 4.2L & 5.0L), 1976-1986 CJ7 (3.8L, 4.2L & 5.0L), 1981-1986 CJ8 (4.2L & 5.0L), 1987-1995 Wrangler (2.5L), 1987-1990 Wrangler (4.2L), 1987-1990 Cherokee (2.5L), Fan Clutch, (With Serpentine Belt) | 17105.02 |
| 1991-1995 Wrangler (4.0L), Fan Clutch | 17105.04 |
| 1997-2002 Wrangler (2.5L), 2003-2006 Wrangler (2.4L), Fan Clutch | 17105.10 |
| 2000-2006 Wrangler (4.0L), Fan Clutch | 17105.12 |
| 1987-1993 Cherokee (4.0L), Fan Clutch | 17105.03 |
| 1997-2000 Cherokee (2.5L With AC), Fan Clutch | 17105.11 |
| 1993-1996 Grand Cherokee (4.0L With HD Cooling), 1997-1998 Grand Cherokee (4.0L), Fan Clutch | 17105.07 |
| 1993-1998 Grand Cherokee (5.2L), 1998 (5.9), Fan Clutch | 17105.09 |
| 1974-1991 Cherokee (SJ) / Grand Wagoner (5.9L & 6.6L), Fan Clutch | 17105.06 |
| 1981-1987 Cherokee (SJ) / Grand Wagoner (4.2L), Fan Clutch, (With V-Belt) (Reverse Rotation) | 17105.06 |
| 1981-1987 Cherokee (SJ) / Grand Wagoner (4.2L), Fan Clutch, (With Serpentine Belt) | 17105.08 |
| 1981-1987 Cherokee (SJ) / Grand Wagoner (4.2L), Fan Clutch, (With V-Belt) | 17105.05 |

K. Electric Cooling Fans

Part#

| | |
|---|----------|
| 2007-2011 Wrangler (3.8L), Fan Assembly NEW | 17102.57 |
| 1987-1996 Cherokee (4.0L), Fan Assembly | 17102.51 |
| 1997-1999 Cherokee (2.5L), 1997-2001 Cherokee (4.0L), Fan Assembly | 17102.52 |
| 1999-2004 Grand Cherokee 1999-2004 (4.0L), 1999-2001 (4.7L), 2002-2007 Liberty (3.7L), Fan Assembly | 17102.53 |
| 2005-2010 Grand Cherokee (3.7L & 5.7), 2005-2009 Grand Cherokee (4.7L), 2006-2010 Grand Cherokee (6.1L) Fan Assembly NEW | 17102.54 |
| 2008-2010 Liberty (3.7L), Fan Assembly NEW | 17102.56 |

L. Water Pumps

Part#

| | |
|---|----------|
| 1941-1945 MB, 1941-1945 GPW, 1945-1949 CJ2A, 1948-1953 CJ3A, 1953-1967 CJ3B, 1955-1971 CJ5, 1955-1971 CJ6, Water Pump (For 134 CI) | 17104.01 |
| 1950-1952 M38, 1952-1971 M38A1, Water Pump (With Double Groove Pulley) | 17104.02 |
| 1954-1964 Truck and Station Wagon (226 CI) Water Pump | 17104.09 |
| 1966-1971 CJ5 & CJ6 (225 CI), Water Pump | 17104.10 |
| 1972-1974 CJ5 & CJ6 (3.8L & 4.2L), Water Pump | 17104.11 |
| 1972-1981 CJ5, 1972-1975 CJ6, 1976-1981 CJ7, 1981 CJ8, Water Pump (For 3.8L or 4.2L) | 17104.12 |
| 1972-1981 CJ5, 1972-1975 CJ6, 1976-1981 CJ7, 1981 CJ8, Water Pump (For 5.0L) | 17104.16 |
| 1980-1983 CJ5, 1980-1983 CJ7, 1981-1983 CJ8, Water Pump (For 2.5L GM) | 17104.03 |
| 1980-1983 CJ5, 1980-1986 CJ7, 1981-1986 CJ8, Water Pump (For 4.2L With V-Belt) | 17104.04 |
| 1980-1983 CJ5, 1980-1986 CJ7, 1981-1986 CJ8, 1987-1990 Wrangler (4.2L), Water Pump (For 4.2L With Serpentine Belt) * | 17104.13 |
| 1983 CJ5, 1983-1986 CJ7, 1983-1986 CJ8, Water Pump (For 2.5L AMC With V-Belt) | 17104.04 |
| 1983 CJ5, 1983-1986 CJ7, 1983-1986 CJ8, Water Pump (For 2.5L AMC With Serpentine Belt) | 17104.05 |
| 1991-2002 Wrangler (2.5L), 1987-1990 Wrangler (4.2L), 1991-1999 Wrangler (4.0L), 1987-2000 Cherokee (2.5L), 1991-2000 Cherokee (4.0L), 1998 Grand Cherokee (4.0L), Water Pump * | 17104.07 |
| 1987-1990 Wrangler (4.2L) [Export], Water Pump (With V-Belt) | 17104.06 |
| 2003-2006 Wrangler (2.4L), Water Pump | 17104.08 |
| 1987-2001 Cherokee (4.0L), 1993-1998 Grand Cherokee (4.0L), Water Pump | 17104.14 |
| 2007-2011 Wrangler (3.8L), 2007-2008 (2.8L Diesel With AT), 2007 Wrangler (2.8L Diesel With MT) Water Pump NEW | 17104.22 |
| 1993-1998 Grand Cherokee (5.2L), 1998 Grand Cherokee (5.9L), Water Pump | 17104.17 |
| 1999-2004 Grand Cherokee (4.0L), 2000-2006 Wrangler (4.0L), Water Pump | 17104.20 |
| 1999-2004 Grand Cherokee (4.7L), 2002-2007 Liberty (3.7L), 2005-2007 Grand Cherokee (3.7L & 4.7L), 2006-2009 Commander (3.7L & 4.7L), Water Pump | 17104.19 |
| 2005-2008 Grand Cherokee (5.7L), 2006-2009 Grand Cherokee (6.1L), Water Pump NEW | 17104.21 |
| 2002-2005 Liberty (2.4L), Water Pump | 17104.08 |

M. Water Pump Gaskets & Components

Part#

| | |
|---|----------|
| 1941-1945 MB, 1941-1945 GPW, 1945-1949 CJ2A, 1948-1953 CJ3A, 1953-1967 CJ3B, 1955-1971 CJ5, 1955-1971 CJ6, Water Pump Service Kit (For 134 CI) | 17104.80 |
| 1941-1945 MB, 1941-1945 GPW, 1945-1949 CJ2A, 1948-1953 CJ3A, 1953-1967 CJ3B, 1955-1971 CJ5, 1955-1971 CJ6, Water Pump Impeller (For 134 CI) NEW | 17104.84 |
| 1941-1945 MB, 1941-1945 GPW, 1945-1949 CJ2A, 1948-1953 CJ3A, 1953-1967 CJ3B, 1955-1971 CJ5, 1955-1971 CJ6, Water Pump Impeller Fiber Washer (For 134 CI) NEW | 17104.85 |
| 1941-1945 MB, 1941-1945 GPW, 1945-1949 CJ2A, 1948-1953 CJ3A, 1953-1967 CJ3B, 1955-1971 CJ5, 1955-1971 CJ6, Water Pump Impeller Shaft Seal (For 134 CI) NEW | 17104.86 |
| 1941-1945 MB, 1941-1945 GPW, 1945-1949 CJ2A, 1948-1953 CJ3A, 1953-1967 CJ3B, 1955-1971 CJ5, 1955-1971 CJ6, Water Pump Impeller Bearing (For 134 CI) | 17104.83 |
| 1941-1945 MB, 1941-1945 GPW, 1945-1949 CJ2A, 1948-1953 CJ3A, 1953-1967 CJ3B, 1955-1971 CJ5, 1955-1971 CJ6, Water Pump Gasket (For 134 CI) NEW | 17117.50 |
| 1966-1971 CJ5 & CJ6 (225 CI), Water Pump Gasket | 17119.01 |
| Jeep CJ 1981-1986 (2.5 & 4.2L), Jeep Wrangler 1987-1999 (2.5L, 4.2L & 4.0L), Jeep Cherokee 1987-1999 (4.0L), Jeep Grand Cherokee 1993-1998 (4.0L), Water Pump Gasket NEW | 17104.81 |
| 1999-2004 Grand Cherokee (4.7L), 2002-2007 Liberty (3.7L), Water Pump Gasket | 17119.03 |

* 1987-1990 Wrangler (4.2L) Use 17104.07 For V-Belt And 17104.05 For Serpentine Belt



OMIX-ADA, Inc.



[N] 17103.01



[P] 17117.03



[O] 17106.01



[Q] 17118.05



[R] 17110.02

| N. Overflow Reservoir | Part# |
|---|----------|
| 1981-1983 CJ5, 1981-1986 CJ7, 1981-1986 CJ8, 1987-1995 Wrangler, Radiator Coolant Overflow Reservoir | 17103.01 |
| 1987-1990 Cherokee (4.0L), 1985-1994 Cherokee (2.1L Diesel), Radiator Coolant Overflow Reservoir NEW | 17103.02 |

| O. Thermostats | Part# |
|---|----------|
| 1941-1945 MB, 1941-1945 GPW, 1945-1949 CJ2A, 1948-1953 CJ3A, 1950-1952 M38, 1952-1971 M38A1, 1953-1967 CJ3B, 1955-1971 CJ5, 1955-1971 CJ6, 1946-1964 Truck, 1946-1964 Station Wagon, 1948-1951 Jeepster, Thermostat 160°, (For 134 Ci, 161 Ci & 226 Ci Engines) NEW | 17106.01 |
| 1941-1945 MB, 1941-1945 GPW, 1945-1949 CJ2A, 1948-1953 CJ3A, 1950-1952 M38, 1952-1971 M38A1, 1953-1967 CJ3B, 1955-1971 CJ5, 1955-1971 CJ6, 1946-1964 Truck, 1946-1964 Station Wagon, 1948-1951 Jeepster, Thermostat 180°, (For 134 Ci, 161 Ci & 226 Ci Engines) | 17106.02 |
| 1972-1983 CJ5 (4.2L & 5.0L), 1972-1976 CJ6 (4.2L & 5.0L), 1976-1986 CJ7 (2.5L AMC, 4.2L & 5.0L), 1981-1986 CJ8 (2.5L AMC, 4.2L & 5.0L), 1987-2006 Wrangler (2.4L, 2.5L AMC & 4.0L), 1997-2001 Cherokee (2.5L & 4.0L), 1993-1998 Grand Cherokee (5.2L & 5.9L), Thermostat 195° | 17106.03 |
| 1993-1998 Grand Cherokee (5.2L) 1999-2009 Grand Cherokee (4.7L), 2005-2010 Grand Cherokee (3.7L), 2005-2002-2007 Liberty (3.7L), Thermostat 195° | 17106.05 |
| 2007-2011 Wrangler (3.8L), Thermostat 195° NEW | 17106.06 |

| P. Thermostat Gaskets | Part# |
|--|----------|
| 1941-1945 MB, 1941-1945 GPW, 1945-1949 CJ2A, 1948-1953 CJ3A, 1950-1952 M38, Thermostat Gasket (For 134 Ci With L-Head) | 17117.01 |
| 1941-1945 MB, 1941-1945 GPW, 1945-1949 CJ2A, 1948-1953 CJ3A, 1950-1952 M38, Thermostat Retainer (For 134 Ci With L-Head) | 17107.01 |
| 1952-1971 M38A1, 1953-1967 CJ3B, 1955-1971 CJ5, 1955-1971 CJ6, Thermostat Gasket, (For 134 Ci With F-Head) | 17117.02 |
| 1972-1983 CJ5, 1972-1975 CJ6, 1976-1986 CJ7, 1981-1986 CJ8, 1987-1990 Wrangler, Thermostat Gasket (For 4.2L) | 17117.03 |
| 1972-1983 CJ5, 1972-1975 CJ6, 1976-1981 CJ7, 1981 CJ8, Thermostat Gasket (For 5.0L) | 17117.04 |

| Q. Thermostat Housing | Part# |
|---|----------|
| 1952-1971 M38A1, 1953-1967 CJ3B, 1955-1971 CJ5, 1955-1971 CJ6, Thermostat Housing, (For 134 Ci With F-Head) | 17118.01 |
| 1972-1983 CJ5, 1972-1975 CJ6, 1976-1986 CJ7, 1981-1986 CJ8, Thermostat Housing (For 3.8L & 4.2L) | 17118.04 |
| 1972-1981 CJ5, 1972-1975 CJ6, 1976-1981 CJ7, 1981 CJ8, Thermostat Housing (For 5.0L) | 17118.05 |
| 1981-1983 CJ5, 1981-1986 CJ7, 1981-1986 CJ8, 1987-1990 Wrangler, Thermostat Housing (For 4.2L) | 17118.02 |
| 1983 CJ5, 1983-1986 CJ7, 1983-1986 CJ8, Thermostat Housing (For 2.5L AMC) | 17118.02 |
| 1991-2002 Wrangler (2.5L), 1990-1995 Wrangler (4.0L), Thermostat Housing NEW | 17118.03 |
| 1984-1987 Cherokee (2.5L), 1987-1990 Cherokee (4.0L), 1987 Wrangler (2.5L), Thermostat Housing | 17118.02 |
| 1991-2000 Cherokee (2.5L), 1991-2001 Cherokee (4.0L), 1991-2006 Wrangler (2.4L, 2.5L & 4.0L), 1999-2004 Grand Cherokee (4.0L), Thermostat Housing | 17118.03 |
| 1974-1987 Cherokee (SJ) / Grand Wagoneer (5.9L & 6.6L), Fan Clutch, (With Serpentine Belt) | 17118.05 |

| R. V-Belts | Part# |
|--|----------|
| 1941-1945 MB, 1941-1945 GPW, 1945-1949 CJ2A, 1948-1953 CJ3A, 1953-1967 CJ3B, 1955-1971 CJ5, 1955-1971 CJ6, 1946-1964 Truck, 1946-1964 Station Wagon, 1948-1951 Jeepster, V-Belt (For 134 Ci) | 17110.01 |
| 1950-1952 M38, 1952-1971 M38A1, V-Belt Set (For 134 Ci), Pair | 17110.02 |
| 1976-1983 CJ5, 1976-1986 CJ7, 1981-1986 CJ8, V-Belt (For 3.8L, 4.2L & 5.0L) | 17110.03 |
| 1980-1983 CJ5, 1980-1983 CJ7, 1981-1983 CJ8, V-Belt (For 2.5L GM) | 17110.05 |
| 1985-1994 Cherokee (2.1L Diesel), 1995-1996 Cherokee (2.5L Diesel), V-Belt, Power Steering NEW | 17110.08 |

* In Some Cases The Firewall Hole May Need To Be Enlarged



[S] 17111.05



[T] 17112.02



[T] 17112.01



OMIX-ADA, Inc.



[U] 17112.50

S. Serpentine Belts

| Part# | Part# |
|----------|--|
| 17110.06 | 1980-1983 CJ5, 1980-1983 CJ7, 1981-1983 CJ8, V-Belt, Power Steering (For 2.5L GM) |
| 17110.07 | 1981-1982 CJ5, 1981-1982 CJ7, Serpentine Belt (For 4.2L Without AC, With PS) NEW |
| 17111.42 | 1981-1982 CJ5, 1981-1982 CJ7, Serpentine Belt (For 4.2L With AC, With PS) NEW |
| 17111.27 | 1987-1990 Wrangler (4.2L With AC, Without PS), Serpentine Belt |
| 17111.28 | 1987-1990 Wrangler (4.2L With AC, With PS), Serpentine Belt |
| 17111.15 | 1991-1994 Wrangler (2.5L & 4.0L Without AC, With PS), Serpentine Belt |
| 17111.06 | 1991-1993 Wrangler (2.5L & 4.0L With AC, With PS), Serpentine Belt |
| 17111.08 | 1991-1995 Wrangler (2.5L & 4.0L Without AC, Without PS), Serpentine Belt |
| 17111.15 | 1994-1995 Wrangler (RHD) (2.5L & 4.0L Without AC, With PS), Serpentine Belt |
| 17111.12 | 1995 Wrangler (2.5L & 4.0L Without AC, With PS), Serpentine Belt |
| 17111.18 | 1995-1998 Wrangler (2.5L & 4.0L With AC, With PS), Serpentine Belt |
| 17111.11 | 1997-2002 Wrangler (2.5L Without AC, Without PS), Serpentine Belt |
| 17111.12 | 1997-2002 Wrangler (2.5L Without AC, With PS), 1997-1999 Wrangler (4.0L Without AC, Without PS), Serpentine Belt |
| 17111.21 | 2000-2006 Wrangler (4.0L Without AC), Serpentine Belt |
| 17111.23 | 2000-2006 Wrangler (4.0L With AC), Serpentine Belt |
| 17111.31 | 2003-2006 Wrangler (2.4L With AC), Serpentine Belt |
| 17111.39 | 2007-2011 Wrangler (3.8L Without AC), Serpentine Belt NEW |
| 17111.38 | 2007-2011 Wrangler (3.8L With AC), Serpentine Belt NEW |
| 17111.05 | 1984-1990 Cherokee (2.5L Without AC), Serpentine Belt |
| 17111.03 | 1984-1990 Cherokee (2.5L With AC), Serpentine Belt |
| 17111.04 | 1987-1990 Cherokee (4.0L), Serpentine Belt |
| 17111.06 | 1991-1995 Cherokee (2.5L With AC, With PS), Serpentine Belt |
| 17111.15 | 1991-1995 Cherokee (2.5L Without AC, With PS), 1993-1995 Grand Cherokee (4.0L Without AC), Serpentine Belt |
| 17111.08 | 1991-1993 Cherokee (2.5L Without AC, Without PS), Serpentine Belt |
| 17111.13 | 1991-1995 Cherokee (4.0L), Serpentine Belt |
| 17111.14 | 1991-1995 Cherokee (RHD) (4.0L), Serpentine Belt |
| 17111.12 | 1996-2000 Cherokee (2.5L Without AC), Serpentine Belt |
| 17111.18 | 1996-2000 Cherokee (2.5L With AC, With PS), Serpentine Belt |
| 17111.16 | 1996-2000 Cherokee (RHD) (2.5L Without AC), Serpentine Belt |
| 17111.17 | 1996-2000 Cherokee (RHD) (2.5L With AC), Serpentine Belt |
| 17111.17 | 1996-2001 Cherokee (4.0L), Serpentine Belt |
| 17111.10 | 1996-2001 Cherokee (RHD) (4.0L), Serpentine Belt |
| 17111.24 | 1993-1995 Grand Cherokee (4.0L Without AC), Serpentine Belt |
| 17111.07 | 1993-1994 Grand Cherokee (5.2L), Serpentine Belt |
| 17111.26 | 1995-1996 Grand Cherokee (5.2L), Serpentine Belt |

S. Serpentine Belts cont.

| Part# | Part# |
|----------|---|
| 17111.09 | 1996-1998 Grand Cherokee (4.0L), 1997-2002 Wrangler (2.5L With AC), Serpentine Belt |
| 17111.01 | 1993-1995 Grand Cherokee (4.0L With AC), Serpentine Belt |
| 17111.40 | 1993-1995 Grand Cherokee (2.5L Diesel), Serpentine Belt NEW |
| 17111.10 | 1996-1998 Grand Cherokee (RHD) (4.0L With AC, With 117 or 136 Amp Alternator), Serpentine Belt |
| 17111.35 | 1996 Grand Cherokee (2.5L Diesel), Serpentine Belt NEW |
| 17111.19 | 1997-1998 Grand Cherokee (5.2L), 1998 Grand Cherokee (5.9L), Serpentine Belt |
| 17111.22 | 1999-2004 Grand Cherokee (4.7L), Serpentine Belt |
| 17111.23 | 1999-2004 Grand Cherokee (4.0L), Serpentine Belt |
| 17111.30 | 1999-2001 Grand Cherokee (Export Models) (3.1L Diesel), Serpentine Belt |
| 17111.33 | 2005-2006 Grand Cherokee (3.7L & 4.7L), Serpentine Belt |
| 17111.34 | 2005-2006 Grand Cherokee (3.7L & 4.7L), Serpentine Belt, Accessory Drive |
| 17111.36 | 2005-2008 Grand Cherokee (5.7L), Serpentine Belt NEW |
| 17111.43 | 2006-2010 Grand Cherokee (6.1L), Serpentine belt NEW |
| 17111.44 | 2009-2010 Grand Cherokee (5.7L), Serpentine belt NEW |
| 17111.45 | 2011-2012 Grand Cherokee (3.6L With Electro Hydraulic Power Steering), Serpentine belt NEW |
| 17111.46 | 2011-2012 Grand Cherokee (3.6L With Mechanical Steering), Serpentine belt NEW |
| 17111.31 | 2002-2005 Liberty (2.4L With AC), Serpentine Belt |
| 17111.37 | 2002-2003 Liberty (2.5L Diesel), 2005-2006 Liberty (2.8L Diesel), Serpentine Belt NEW |

T. Idler Pulley

| Part# | Part# |
|----------|--|
| 17112.02 | 1997-2002 Wrangler (2.5L), 2000-2006 Wrangler (4.0L), Idler Pulley |
| 17112.02 | 2000-2006 Wrangler (4.0L), 1999-2004 Grand Cherokee (4.0L), 1999-2007 Grand Cherokee (4.7), Idler Pulley |
| 17112.01 | 1991-1996 Cherokee (4.0L), 1993-1996 Grand Cherokee (4.0L) Upper, Idler Pulley |
| 17112.04 | 1996-2001 Cherokee (RHD) (4.0L), 2001-2002 Wrangler (2.5L), Upper Idler Pulley |
| 17112.03 | 1993-1998 Grand Cherokee (5.2L), 1998 Grand Cherokee (5.9L), Idler Pulley |
| 17112.04 | 1997-1998 Grand Cherokee (4.0L), Upper Idler Pulley |
| 17112.05 | 2002-2005 Liberty (2.4L), Idler Pulley |
| 17112.07 | 2007-2011 Wrangler (3.8L), Grand Cherokee 2007-2010 (5.7L & 6.1L), Idler Pulley |

U. Tensioner

| Part# | Part# |
|----------|---|
| 17112.09 | 2005-2006 Wrangler (4.0L), Tensioner With Idler Pulley NEW |
| 17112.51 | 2007-2011 Wrangler, Tension With Idler Pulley NEW |
| 17112.50 | 1993-1998 Grand Cherokee (5.2L), 1998 Grand Cherokee (5.9L), Tensioner With Idler Pulley |
| 17112.51 | 1999-2004 Grand Cherokee (4.0L), 1999-2007 Grand Cherokee (4.7), 2002-2006 Grand Cherokee (3.7L), 2002-2007 Liberty (3.7) Tensioner With Idler Pulley |
| 17112.55 | 2005-2008 Grand Cherokee (5.7L), 2006-2009 Grand Cherokee (6.1L), Tensioner With idler Pulley NEW |
| 17112.52 | 2002-2005 Liberty (2.4L), Tensioner With Idler Pulley |



OMIX-ADA, Inc.

| A. Alternators | Part# |
|---|----------|
| 1975-1979 Jeep CJ5 [3.8L, 4.2L & 5.0L], 1975 CJ6 [3.8L, 4.2L & 5.0L], 1976-1979 CJ7 [3.8L, 4.2L & 5.0L], 1975-1979 Cherokee / Grand Wagoneer [SJ] [4.2L, 5.9L & 6.6L], Alternator [63 Amp] | 17225.01 |
| 1980-1983 CJ5 [2.5L GM, 2.5L AMC & 4.2L], 1980-1986 CJ7 [2.5L GM, 2.5L AMC & 4.2L], 1981-1986 CJ8 [2.5L GM, 2.5L AMC & 4.2L], 1980-1986 Cherokee / Grand Wagoneer [4.2L, 5.9L & 6.6L], Alternator, [63 Amp] | 17225.02 |
| 1980-1983 CJ5 [2.5L GM, 2.5L AMC & 4.2L], 1980-1986 CJ7 [2.5L GM, 2.5L AMC & 4.2L], 1981-1986 CJ8 [2.5L GM, 2.5L AMC & 4.2L], 1980-1986 Cherokee / Grand Wagoneer [4.2L, 5.9L & 6.6L], Alternator, [94 Amp] | 17225.03 |
| 1987-1990 Wrangler [2.5L], 1987-1990 Cherokee [2.5L], Alternator [74 Amp] | 17225.05 |
| 1987-1990 Wrangler [2.5L], 1987-1990 Cherokee [2.5L], Alternator [105 Amp] | 17225.04 |
| 1991-1999 Wrangler [2.5L & 4.0L], 1991-1998 Cherokee [2.5L & 4.0L], 1993-1998 Grand Cherokee [4.0L], Alternator [90 Amp] | 17225.06 |
| 1991-1998 Wrangler [2.5L & 4.0L], 1991-1998 Cherokee [2.5L & 4.0L], 1993-1998 Grand Cherokee [4.0L], Alternator [120 Amp] | 17225.22 |
| 1999-2000 Wrangler [2.5L], 1999 Wrangler [4.0L], 1999-2000 Cherokee [2.5L & 4.0L], Alternator [81 Amp] NEW | 17225.21 |
| 1999-2000 Wrangler [2.5L], 1999 Wrangler [4.0L], 1999-2000 Cherokee [2.5L & 4.0L], Alternator [117 Amp] | 17225.13 |
| 2000 Wrangler [4.0L] Alternator [81 Amp] NEW | 17225.28 |
| 2000 Wrangler [4.0L] Alternator [117 Amp] NEW | 17225.26 |
| 2001-2002 Wrangler [2.5L], Alternator [117 AMP] NEW | 17225.24 |
| 2001-2002 Wrangler [4.0L], Alternator [81 AMP] NEW | 17225.27 |
| 2001-2006 Wrangler [4.0L], Alternator [117 AMP] NEW | 17225.31 |
| 2007-2011 Wrangler [3.8L], Alternator [140 Amp] NEW | 17225.20 |
| 2007-2011 Wrangler [3.8L], Alternator [160 Amp] NEW | 17225.18 |
| 1987-1990 Cherokee [4.0L], Alternator [61 Amp] | 17225.08 |
| 1987-1990 Cherokee [4.0L], Alternator [105 Amp] | 17225.07 |
| 2001 Cherokee [4.0L], Alternator [117 Amp] | 17225.14 |
| 1993-1994 Grand Cherokee [5.2L], Alternator [90 Amp] | 17225.09 |
| 1995-1998 Grand Cherokee [5.2L], 1998 Grand Cherokee [5.9L], Alternator [90 Amp] NEW | 17225.16 |
| 1995-1998 Grand Cherokee [5.2L], 1998 Grand Cherokee [5.9L], Alternator [116 Amp] | 17225.16 |
| 1995-1998 Grand Cherokee [5.2L], 1998 Grand Cherokee [5.9L], Alternator [136 Amp] NEW | 17225.23 |
| 1999-2004 Grand Cherokee [4.0L], Alternator [132 Amp] | 17225.10 |
| 1999-2000 Grand Cherokee [4.7L], Alternator [136 Amp] | 17225.11 |
| 2001-2003 Grand Cherokee [4.7L], 2003-2009 Jeep Liberty [3.7L], Alternator [136 Amp] NEW | 17225.15 |
| 2005-2006 Grand Cherokee [3.7 & 4.7L] 2002-2007 Liberty [3.7L], Alternator [160 Amp] NEW | 17225.25 |
| 2005-2009 Grand Cherokee [5.7L], 2006-2010 Grand Cherokee [6.1L], Alternator [160 Amp] NEW | 17225.32 |
| 2002-2005 Liberty [2.4L], Alternator [136 Amp] | 17225.17 |
| 2005-2006 Liberty [2.8L Diesel], Alternator [150 Amp] NEW | 17225.33 |
| 2003-2009 Jeep Liberty [3.7L], Alternator [136 Amp] NEW | 17225.19 |

| B. Alternator Components | Part# |
|---|----------|
| 1976-1983 CJ5, 1976-1986 CJ7, 1981-1986 CJ8, 1976-1990 Cherokee / Grand Wagoneer, Voltage Regulator [Located in Alternator] | 17226.01 |
| 1976-1983 CJ5, 1976-1986 CJ7, 1981-1986 CJ8, 1976-1990 Cherokee / Grand Wagoneer, Alternator Rectifier | 17226.02 |
| 1976-1983 CJ5, 1976-1986 CJ7, 1981-1986 CJ8, 1976-1990 Cherokee / Grand Wagoneer, Alternator Trio Diode | 17226.03 |
| 1976-1983 CJ5, 1976-1986 CJ7, 1981-1986 CJ8, 1976-1990 Cherokee / Grand Wagoneer, Alternator Needle Bearing | 17226.04 |
| 1976-1983 CJ5, 1976-1986 CJ7, 1981-1986 CJ8, 1976-1990 Cherokee / Grand Wagoneer, Alternator Front Bearing | 17226.05 |
| 1941-1966 Models, Generator Support Bushing, 2 Required | 17470.04 |
| 1941-1966 Models, Generator Bolt | 17470.05 |



[A] 17225.01

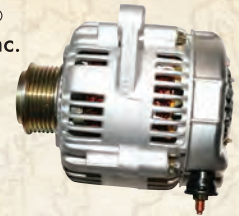

[A] 17225.17



[B] 17470.05

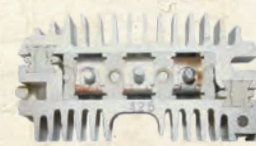

[B] 17226.02



[B] 17226.03



[C] 17227.03



[B] 17226.04

| C. Starters | Part# |
|---|----------|
| 1972-1983 CJ5 [3.8L, 4.2L & 5.0L], 1976-1986 CJ7 [3.8L, 4.2L & 5.0L], 1981-1986 CJ8 [3.8L, 4.2L & 5.0L], 1972-1987 Cherokee / Grand Wagoneer [SJ] [4.2L, 5.9L, 6.6L], Starter | 17227.03 |
| 1987-1993 Wrangler [2.5L EFI], 1987-1993 Cherokee [2.5L EFI], Starter | 17227.04 |
| 1988-2000 Wrangler [4.2L & 4.0L], 1987-1998 Cherokee [4.0L], 1993-1998 Grand Cherokee [4.0L], 1988-1991 Cherokee / Grand Wagoneer [SJ] [6.6L], Starter | 17227.06 |
| 1994-1998 Wrangler [2.5L], 1994-2000 Cherokee [2.5L], Starter | 17227.05 |
| 1999-2002 Wrangler [2.5L], Starter [With AT] | 17227.09 |
| 1999-2002 Wrangler [2.5L], Starter [With MT] | 17227.10 |
| 2003-2006 Wrangler [4.0L], Starter [With AT] | 17227.16 |
| 2003 Wrangler [2.4L], Liberty [2.4L], Starter NEW | 17227.23 |
| 2004-2006 Wrangler [2.4L], 2004-2005 Liberty [2.4L], Starter NEW | 17227.24 |
| 2004-2006 Wrangler [4.0L], Starter [With MT] | 17227.13 |
| 2007-2008 Wrangler [3.8L With AT or MT], 2009-2011 Wrangler [3.8L With MT], Starter NEW | 17227.18 |
| 2009-2011 Wrangler [3.8L With AT], Starter NEW | 17227.19 |
| 1999-2001 Cherokee [4.0L], 1999-2002 Grand Cherokee [4.0L], Starter | 17227.08 |
| 1993-1998 Grand Cherokee [5.2L], 1998 Grand Cherokee [5.9L] | 17227.07 |
| 2003-2004 Grand Cherokee [4.0L], Starter | 17227.13 |
| 2003-2004 Grand Cherokee [4.7L], Starter NEW | 17227.14 |
| 2005-2010 Grand Cherokee [3.7L], Starter [1.2 Kw] NEW | 17227.27 |
| 2005-2009 Grand Cherokee [4.7L], 2006-2007 Liberty [3.7L] Starter [1.2 Kw] NEW | 17227.17 |
| 2005-2008 Grand Cherokee [5.7L], Starter [1.4 Kw] NEW | 17227.28 |
| 2006-2010 Grand Cherokee [6.1L], Starter NEW | 17227.22 |
| 2002-2003 Liberty [3.7L], Starter NEW | 17227.25 |
| 2004-2005 Liberty [3.7L], Starter NEW | 17227.26 |
| 2008-2010 Liberty [3.7L] Starter [1.2 Kw] NEW | 17227.20 |



OMIX-ADA, Inc.



For restoration purposes this distributor has been crafted to look like the original, but on the inside it's a whole new story. The troublesome points have been replaced with a state of the art electromagnetic pickup and a built-in electronic control module. With the hookup of the two simple wires (installation instructions included), this distributor will improve the performance and driveability of any 12-volt 134cl, or 226 cl engine. No more fooling around in trying to get the points adjusted to the correct setting. Just drop in, plug in and go. (Will not work with 6-volt models and is not original for M38 or M38A1). For replacement parts specifically for this distributor, order module #17252.05, cap #17244.02, and rotor 17246.02.

D. Starter Components

Part#

| | |
|---|----------|
| MB 1941-1945, Ford GPW 1941-1945, CJ2A 1945-1949, CJ3A 1948-1953, Starter Brush Set (134 Cl)] NEW | 17228.13 |
| 1972-1977 CJ5 (3.8L, 4.2L & 5.0L), 1976-1977 CJ7 (3.8L, 4.2L & 5.0L), 1972-1977 Cherokee / Grand Wagoneer (SJ) (4.2L, 5.9L, 6.6L), Starter Bushing (9/16") NEW | 17228.09 |
| 1978-1983 CJ5 (3.8L, 4.2L & 5.0L), 1978-1986 CJ7 (3.8L, 4.2L & 5.0L), 1981-1986 CJ8 (3.8L, 4.2L & 5.0L), 1978-1987 Cherokee / Grand Wagoneer (SJ) (4.2L, 5.9L, 6.6L), Starter Armature Bushing (Housing End Bushing) NEW | 17228.12 |
| 1954-1964 Truck (226 Cl), 1954-1964 Station Wagon (226 Cl), Starter Brush Set NEW | 17228.11 |
| 1972-1977 CJ5 (3.8L, 4.2L & 5.0L), 1976-1977 CJ7 (3.8L, 4.2L & 5.0L), 1972-1977 Cherokee / Grand Wagoneer (SJ) (4.2L, 5.9L, 6.6L), Starter Brush Set] NEW | 17228.10 |
| 1988-2000 Wrangler (4.2L & 4.0L), 1987-1998 Cherokee (4.0L), 1993-1998 Grand Cherokee (4.0L), 1988-1991 Cherokee / Grand Wagoneer (SJ) (6.6L), Starter Brush Set | 17228.06 |
| 1988-2000 Wrangler (4.2L & 4.0L), 1987-1998 Cherokee (4.0L), 1993-1998 Grand Cherokee (4.0L), 1988-1991 Cherokee / Grand Wagoneer (SJ) (6.6L), Starter Brush Holder | 17228.07 |
| 1953-1967 CJ3B, 1955-1971 CJ5, 1955-1971 CJ6, Starter Drive (With 134 Cl) * | 17229.01 |
| 1953-1967 CJ3B, 1955-1971 CJ5, 1955-1971 CJ6, 1946-1964 Truck, 1946-1964 Station Wagon, Starter Drive (With 134 Cl or 226) ** | 17229.02 |
| 1972-1983 CJ5 (3.8L, 4.2L & 5.0L), 1976-1986 CJ7 (3.8L, 4.2L & 5.0L), 1981-1986 CJ8 (3.8L, 4.2L & 5.0L), 1972-1987 Cherokee / Grand Wagoneer (SJ) (4.2L, 5.9L, 6.6L), Starter Drive | 17229.03 |
| 1988-2000 Wrangler (4.2L & 4.0L), 1987-1998 Cherokee (4.0L), 1993-1998 Grand Cherokee (4.0L), 1988-1991 Cherokee / Grand Wagoneer (SJ) (6.6L), Starter Drive | 17229.04 |
| 1972-1977 CJ5 (3.8L, 4.2L & 5.0L), 1976-1977 CJ7 (3.8L, 4.2L & 5.0L), 1972-1977 Cherokee / Grand Wagoneer (SJ) (4.2L, 5.9L, 6.6L), Starter End Housing | 17228.04 |
| 1978-1983 CJ5 (3.8L, 4.2L & 5.0L), 1978-1986 CJ7 (3.8L, 4.2L & 5.0L), 1981-1986 CJ8 (3.8L, 4.2L & 5.0L), 1978-1987 Cherokee / Grand Wagoneer (SJ) (4.2L, 5.9L, 6.6L), Starter End Housing | 17228.05 |
| 1972-1983 CJ5 (3.8L, 4.2L & 5.0L), 1976-1986 CJ7 (3.8L, 4.2L & 5.0L), 1981-1986 CJ8 (3.8L, 4.2L & 5.0L), 1972-1987 Cherokee / Grand Wagoneer (SJ) (4.2L, 5.9L, 6.6L), Starter Armature | 17228.01 |
| 1972-1983 CJ5 (3.8L, 4.2L & 5.0L), 1976-1986 CJ7 (3.8L, 4.2L & 5.0L), 1981-1986 CJ8 (3.8L, 4.2L & 5.0L), 1972-1987 Cherokee / Grand Wagoneer (SJ) (4.2L, 5.9L, 6.6L), Starter Points Set | 17228.02 |
| 1972-1983 CJ5 (3.8L, 4.2L & 5.0L), 1976-1986 CJ7 (3.8L, 4.2L & 5.0L), 1981-1986 CJ8 (3.8L, 4.2L & 5.0L), 1972-1987 Cherokee / Grand Wagoneer (SJ) (4.2L, 5.9L, 6.6L), Starter Coil Field | 17228.03 |

E. Starter Solenoids

Part#

| | |
|--|----------|
| 1953-1967 CJ3B, 1955-1971 CJ5, 1955-1971 CJ6, 1946-1964 Truck, 1946-1964 Station Wagon, Starter Solenoid * | 17230.01 |
| 1972-1979 CJ5, 1972-1975 CJ, 1976-1979 CJ7, 1972-1979 Cherokee / Grand Wagoneer (SJ), Starter Solenoid | 17230.02 |
| 1980-1983 CJ5, 1980-1986 CJ7, 1981-1986 CJ8, 1980-1986 Cherokee / Grand Wagoneer (SJ), Starter Solenoid (With AT) | 17230.04 |
| 1980-1983 CJ5, 1980-1986 CJ7, 1981-1986 CJ8, 1980-1986 Cherokee / Grand Wagoneer (SJ), Starter Solenoid (With MT) | 17230.03 |
| 1983 CJ5, 1983-1986 CJ7, 1983-1986 CJ8, Starter Solenoid (With MT) | 17230.05 |
| 1987-1990 Wrangler (4.2L), 1987-1990 Cherokee (4.0L), 1987-1990 Cherokee (2.1L Diesel), Starter Solenoid | 17230.06 |
| 1988-1990 Wrangler (4.2L), 1991-1995 Wrangler (4.0L), 1987-1996 Cherokee (4.0L), 1993-1996 Grand Cherokee (4.0L), Starter Solenoid (In Bosch Starters) | 17230.07 |

F. New Distributors

Part#

| | |
|---|----------|
| 1941-1945 MB, 1941-1945 Ford GPW, 1945-1949 CJ2A, 1948-1953 CJ3A, 1953-1967 CJ3B, 1952-1971 M38A1, 1955-1971 CJ5, 1955-1971 CJ6, 1946-1964 Truck, 1946-1964 Station Wagon, Distributor, Electronic Solid State (For 134 Cl) UPGRADED * | 17239.01 |
| 1954-1964 Truck and Station Wagon, Electronic Solid State (For 226 Cl) UPGRADED / NEW | 17239.08 |
| 1978-1983 CJ5, 1978-1986 CJ7, 1981-1986 CJ8, 1978-1990 Cherokee / Grand Wagoneer (SJ), Distributor (For 4.2L) NEW | 17239.02 |
| 1978-1983 CJ5, 1978-1986 CJ7, 1981-1986 CJ8, 1978-1990 Cherokee / Grand Wagoneer (SJ), Distributor Kit (For 4.2L), With Cap & Rotor | 17239.03 |
| 1978-1981 CJ5 (5.0L), 1978-1981 CJ7 (5.0L), 1981 CJ8 (5.0L), 1978-1991 Cherokee / Grand Wagoneer (SJ) (5.9L & 6.6L) Distributor Kit, With Cap & Rotor | 17239.06 |
| 1991-1993 Wrangler, 1991-1993 Cherokee, 1993 Grand Cherokee, Distributor (For 4.0L) | 17239.04 |
| 1994-1997 Wrangler, 1994-1997 Cherokee, 1994-1997 Grand Cherokee, Distributor (For 4.0L) | 17239.05 |
| 1972-1974 CJ5 (3.8L & 4.2L), 1972-1974 CJ6 (3.8L & 4.2L), 1972-1974 Cherokee / Grand Wagoneer (SJ) (4.2L), Distributor Kit, With Cap & Rotor | 17240.01 |
| 1975-1977 CJ5 (3.8L & 4.2L), 1975 CJ6 (3.8L & 4.2L), 1976-1977 CJ7 (3.8L & 4.2L), 1981 CJ8 (5.0L), 1978-1991 Cherokee / Grand Wagoneer (SJ) (5.9L & 6.6L) Distributor Kit, With Cap & Rotor (Prestolite) ** | 17240.02 |

* Autolite MCH-6203, MCH-6307, MCM-6005, MDU-7004 w/6 or 12 Volt
 ** Starter MDU-7003, 7004 w/ 12 Volt

* 12 Volt Only
 ** Remanufactured



[G] 17244.07

[J] 17246.14



[H] 17242.01

[K] 17241.01

G. Distributor Caps

| Part# | |
|----------|--|
| 17244.01 | 1941-1945 MB, 1941-1945 Ford GPW, 1945-1949 CJ2A, 1948-1953 CJ3A, 1953-1958 CJ3B, 1955-1958 CJ5, 1955-1958 CJ6, 1946-1958 Truck, 1946-1958 Station Wagon, 1948-1951 Jeepster, Distributor Cap [6 Volt] |
| 17244.03 | 1950-1952 M38, 1952-1971 M38A1, Distributor Cap [24 Volt] |
| 17244.03 | 1953-71 M38A1 4 Cyl, 24V |
| 17244.02 | 1959-1967 CJ3B, 1959-1971 CJ5, 1959-1971 CJ6, 1959-1964 Truck, 1959-1964 Station Wagon, Distributor Cap [12 Volt] |
| 17244.06 | 1954-1964 Truck & Station Wagon [226 CI], 1962-1965 Truck & Station wagon [230 CI], 1963-1964 Wagoneer / Gladiator [230 CI], Distributor Points |
| 17244.07 | 1972-1974 CJ5 [3.8L & 4.2L], 1972-1974 CJ6 [3.8L & 4.2L], 1972-1974 Cherokee / Grand Wagoneer [SJ] [4.2L], Distributor Cap [Points Style] |
| 17244.13 | 1972-1974 CJ5 [5.0L], 1972-1974 CJ6 [5.0L], 1972-1974 Cherokee / Grand Wagoneer [SJ] [5.9L & 6.6L], Distributor Cap [Points Style] |
| 17244.08 | 1975-1977 CJ5 [3.8L & 4.2L], 1975-1977 CJ6 [3.8L & 4.2L], 1975-1977 Cherokee / Grand Wagoneer [SJ] [4.2L], Distributor Cap [Prestolite] |
| 17244.14 | 1975-1977 CJ5 [5.0L], 1975-1977 CJ6 [5.0L], 1975-1977 Cherokee / Grand Wagoneer [SJ] [5.9L & 6.6L], Distributor Cap [Prestolite] |
| 17244.09 | 1978-1983 CJ5, 1978-1986 CJ7, 1981-1986 CJ8, 1987-1990 Wrangler, 1978-1990 Cherokee / Grand Wagoneer [SJ], Distributor Cap [For 4.2L] |
| 17244.15 | 1978-1981 CJ5 [5.0L], 1978-1981 CJ7 [5.0L], 1981 CJ8 [5.0L], 1978-1991 Cherokee / Grand Wagoneer [SJ] [5.9L & 6.6L] Distributor Cap |
| 17244.04 | 1983 CJ5, 1983-1986 CJ7, 1983-1986 CJ8, 1987-1990 Wrangler, 1984-1990 Cherokee, Distributor Cap [2.5L AMC] |
| 17244.05 | 1991-2002 Wrangler [2.5L], 1991-2000 Cherokee [2.5L], Distributor Cap |
| 17244.10 | 1991-1993 Wrangler [4.0L], 1987-1993 Cherokee [4.0L], 1993 Grand Cherokee [4.0L], Distributor Cap |
| 17244.11 | 1994-2000 Wrangler [4.0L], 1994-2000 Cherokee [4.0L], 1994-1998 Grand Cherokee [4.0L], Distributor Cap |
| 17244.16 | 1993-1998 Grand Cherokee [5.2L], 1998 Grand Cherokee [5.9L], Distributor Cap |

H. Distributor Condensers

| Part# | |
|----------|--|
| 17242.01 | 1941-1945 MB, 1941-1945 Ford GPW, 1945-1949 CJ2A, 1948-1953 CJ3A, 1953-1967 CJ3B, 1955-1971 CJ5, 1955-1971 CJ6, 1946-1964 Truck, 1946-1964 Station Wagon, Distributor Condenser [For 134 CI] |
| 17242.02 | 1966-1971 CJ5 & CJ6 [225 CI], Distributor Condenser |
| 17242.03 | 1972-1974 CJ5 [3.8L & 4.2L], 1972-1974 CJ6 [3.8L & 4.2L], 1972-1974 Cherokee / Grand Wagoneer [SJ] [4.2L], Distributor Condenser |
| 17242.02 | 1972-1974 CJ5 [5.0L], 1972-1974 CJ6 [5.0L], 1972-1974 Cherokee / Grand Wagoneer [SJ] [5.9L & 6.6L], Distributor Condenser |

I. Distributor Points

| Part# | |
|----------|---|
| 17243.01 | 1941-1945 MB, 1941-1945 Ford GPW, 1945-1949 CJ2A, 1948-1953 CJ3A, 1953-1967 CJ3B, 1955-1971 CJ5, 1955-1971 CJ6, 1946-1964 Truck, 1946-1964 Station Wagon, Distributor Points [For 134 CI] |
| 17243.02 | 1954-1964 Truck & Station Wagon [226 CI], 1962-1965 Truck & Station wagon [230 CI], 1962-1964 Wagoneer / Gladiator [230 CI], Distributor Points |
| 17243.04 | 1966-1971 CJ5 [225 CI], 1966-1971 CJ6 [225 CI], 1972-1974 CJ5 [5.0L], 1972-1974 CJ6 [5.0L], 1972-1974 Cherokee / Grand Wagoneer [SJ] [5.9L & 6.6L], Distributor Points |
| 17243.03 | 1972-1974 CJ5 [3.8L & 4.2L], 1972-1974 CJ6 [3.8L & 4.2L], 1972-1974 Cherokee / Grand Wagoneer [SJ] [4.2L], 1965- 1970 J Series Truck, Distributor Points |

J. Distributor Rotors

| Part# | |
|----------|--|
| 17246.01 | 1941-1945 MB, 1941-1945 Ford GPW, 1945-1949 CJ2A, 1948-1953 CJ3A, 1953-1958 CJ3B, 1955-1958 CJ5, 1955-1958 CJ6, 1946-1958 Truck, 1946-1958 Station Wagon, 1948-1951 Jeepster, Distributor Rotor [6 Volt] |
| 17246.20 | 1954-1964 Truck & Station Wagon [226 CI], Distributor Rotor NEW |
| 17246.02 | 1959-1967 CJ3B, 1959-1971 CJ5, 1959-1971 CJ6, 1959-1964 Truck, 1959-1964 Station Wagon, Distributor Rotor [12 Volt] |
| 17246.07 | 1972-1974 CJ5 [3.8L & 4.2L], 1972-1974 CJ6 [3.8L & 4.2L], 1972-1974 Cherokee / Grand Wagoneer [SJ] [4.2L], 1965- 1970 J Series Truck, Distributor Rotor |
| 17246.12 | 1972-1974 CJ5 [5.0L], 1972-1974 CJ6 [5.0L], 1972-1974 Cherokee / Grand Wagoneer [SJ] [5.9L], 1965-1970 J Series Truck, Distributor Rotor NEW |
| 17246.08 | 1975-1977 CJ5 [3.8L & 4.2L], 1975-1977 CJ6 [3.8L & 4.2L], 1975-1977 Cherokee / Grand Wagoneer [SJ] [4.2L], Distributor Rotor [Prestolite] |
| 17246.13 | 1975-1977 CJ5 [5.0L], 1975-1977 CJ6 [5.0L], 1975-1977 Cherokee / Grand Wagoneer [SJ] [5.9L & 6.6L], Distributor Rotor [Prestolite] |
| 17246.09 | 1978-1983 CJ5, 1978-1986 CJ7, 1981-1986 CJ8, 1987-1990 Wrangler, 1978-1990 Cherokee / Grand Wagoneer [SJ], Distributor Rotor [For 4.2L] |
| 17246.14 | 1978-1981 CJ5 [5.0L], 1978-1981 CJ7 [5.0L], 1981 CJ8 [5.0L], 1978-1991 Cherokee / Grand Wagoneer [SJ] [5.9L & 6.6L] Distributor Rotor |
| 17246.04 | 1983 CJ5, 1983-1986 CJ7, 1983-1986 CJ8, 1987-1990 Wrangler, 1984-1990 Cherokee, Distributor Rotor [2.5L AMC] |
| 17246.05 | 1991-1993 Wrangler, 1987-1993 Cherokee, 1993 Grand Cherokee, Distributor Rotor [For 4.0L] |
| 17246.06 | 1994-2000 Wrangler [4.0L], 1994-2000 Cherokee [4.0L], 1994-1998 Grand Cherokee [4.0L], Distributor Rotor |
| 17244.12 | 1984-1986 Cherokee [2.8L], Distributor Rotor |
| 17246.15 | 1993-1998 Grand Cherokee [5.2L], 1998 Grand Cherokee [5.9L], Distributor Rotor |

K. Distributor Sensors

| Part# | |
|----------|---|
| 17241.01 | 1978-1981 CJ5 [5.0L], 1978-1981 CJ7 [5.0L], 1981 CJ8 [5.0L], 1978-1991 Cherokee / Grand Wagoneer [SJ] [5.9L & 6.6L] Distributor Sensor |
| 17241.02 | 1987-1990 Wrangler, 1984-1990 Cherokee, Distributor Sensor [2.5L AMC] |
| 17241.03 | 1991-1995 Wrangler [2.5L & 4.0L], 1991-1997 Cherokee [2.5L & 4.0L], 1993-1997 Grand Cherokee [4.0L], Distributor Switch Plate |
| 17241.05 | 1998-2002 Wrangler [2.5L & 4.0L], 1998-2000 Cherokee [2.5L], 1998-2001 Cherokee [4.0L], 1998-2002 Grand Cherokee [4.0L], Distributor Switch Plate |
| 17241.04 | 1993-1997 Grand Cherokee [5.2L], Distributor Switch Plate |



[L] 17252.01



[N] 17245.18



[M] 17247.01

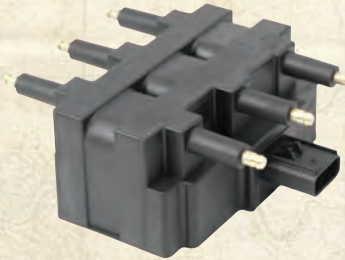

[M] 17247.15



[M] 17247.14



OMIX-ADA, Inc.



[N] 17245.02



[M] 17247.07

L. Ignition Modules

Part#

| | |
|--|----------|
| 1941-1945 MB, 1941-1945 Ford GPW, 1945-1949 CJ2A, 1948-1953 CJ3A, 1953-1967 CJ3B, 1952-1971 M38A1, 1955-1971 CJ5, 1955-1971 CJ6, 1946-1964 Truck, 1946-1964 Station Wagon, Distributor, Ignition Module [For 17239.01] | 17252.05 |
| 1954-1964 Truck and Station Wagon, Ignition Module [For 17239.08] NEW | 17252.06 |
| 1975-1977 CJ5 (3.8L, 4.2L & 5.0L), 1975-1977 CJ6 (3.8L, 4.2L & 5.0L), 1975-1977 Cherokee / Grand Wagoneer (SJ) (4.2L), Ignition Module (Prestolite) | 17252.01 |
| 1978-1979 CJ5 (3.8L), 1978-1983 CJ5 (4.2L) 1983 CJ5 (2.5L AMC), 1978-1979 CJ7 (3.8L), 1978-1986 CJ7 (4.2L), 1983-1986 CJ7 (2.5L AMC), 1981-1986 CJ8 (4.2L), 1983-1986 CJ8 (2.5L AMC), 1987 Wrangler (2.5L & 4.0L), 1984-1987 Cherokee (2.5L), 1978-1987 Cherokee / Grand Wagoneer (SJ) (4.2L, 5.9L & 6.6L), Modules Ignition | 17252.02 |
| 1988-1990 Wrangler (2.5L & 4.2L), 1988-1990 Cherokee (2.5L & 4.0L), 1988-1991 Grand Wagoneer (SJ) (5.9L) | 17252.03 |

M. Ignition Coils

Part#

| | |
|---|----------|
| 1941-1945 MB, 1941-1945 Ford GPW, 1945-1949 CJ2A, 1948-1953 CJ3A, 1953-1958 CJ3B, 1955-1958 CJ5, 1955-1958 CJ6, 1946-1958 Truck, 1946-1958 Station Wagon, 1948-1951 Jeepster, Ignition Coil (6 Volt) | 17247.01 |
| 1959-1967 CJ3B, 1959-1971 CJ5, 1959-1971 CJ6, 1959-1964 Truck, 1959-1964 Station Wagon, Ignition Coil (12 Volt) | 17247.02 |
| 1972-1974 CJ5 (3.8L, 4.2L & 5.0L), 1972-1974 CJ6 (3.8L, 4.2L & 5.0L), 1972-1974 Cherokee / Grand Wagoneer (SJ) (4.2L & 5.9L), Distributor Cap (Points Style) | 17247.06 |
| 1975-1977 CJ5 (3.8L, 4.2L & 5.0L), 1975-1977 CJ6 (3.8L, 4.2L & 5.0L), 1975-1977 Cherokee / Grand Wagoneer (SJ) (4.2L), Ignition Coil (Prestolite) | 17247.07 |
| 1978-1983 CJ5 (4.2L) 1983 CJ5 (2.5L AMC), 1978-1986 CJ7 (4.2L), 1983-1986 CJ7 (2.5L AMC), 1981-1986 CJ8 (4.2L), 1983-1986 CJ8 (2.5L AMC), 1987-1990 Wrangler (2.5L & 4.0L), 1984-1990 Cherokee (2.5L), 1978-1990 Cherokee / Grand Wagoneer (SJ) (4.2L), Ignition Coil | 17247.03 |
| 1991-1997 Wrangler (2.5L & 4.0L), 1991-1997 Cherokee (2.5L & 4.0L), 1993-1997 Grand Cherokee (4.0L & 5.2L), Ignition Coil | 17247.04 |
| 1998-2002 Wrangler (2.5L), 1998-1999 Wrangler (4.0L), 1998-2000 Cherokee (2.5L), 1998-1999 Cherokee (4.0L), 1998-1999 Grand Cherokee (4.0L), 1998 Grand Cherokee (5.2L & 5.9L), Ignition Coil | 17247.05 |
| 1999-2004 Grand Cherokee (4.7L), 2002-2007 Liberty (3.7L), 2005-2007 Grand Cherokee (4.7L), 2006-2007 Grand Cherokee (3.7L), Ignition Coil | 17247.11 |
| 2003-2006 Wrangler (2.4L), 2002-2005 Liberty (2.4L), Ignition Coil | 17247.12 |
| 2007-2011 Wrangler (3.8L), Ignition Coil NEW | 17247.15 |
| 1984-1986 Cherokee (2.5L), Ignition Coil | 17247.03 |
| 1984-1986 Cherokee (2.8L), Ignition Coil | 17247.08 |
| 1987-1990 Cherokee (2.5L With EFI), Ignition Coil | 17247.09 |
| 2005 Grand Cherokee (3.7L), Ignition Coil | 17247.14 |

N. Ignition (Spark Plug) Wire Sets

Part#

| | |
|---|----------|
| 1952-1971 M38A1, 1953-1967 CJ3B, 1955-1971 CJ5, 1955-1971 CJ6, Ignition Wire Set, [For 134 CI With F-Head] | 17245.02 |
| 1954-1964 Truck & Station Wagon (226 CI), 1962-1965 Truck & Station wagon (230 CI), 1963-1964 Wagoneer / Gladiator (230 CI), Wire Set | 17245.07 |
| 1972-1977 CJ5 (3.8L & 4.2L), 1976-1977 CJ7 (3.8L & 4.2L), 1981-1977 CJ8 (3.8L & 4.2L), 1972-1977 Cherokee / Grand Wagoneer (SJ) (4.2L), Ignition Wire Set | 17245.08 |
| 1972-1981 CJ5 (5.0L), 1976-1981 CJ7 (5.0L), 1981 CJ8 (5.0L), 1972-1985 Cherokee / Grand Wagoneer (SJ) (5.0L, 5.9L, 6.6L), Ignition Wire Set | 17245.13 |
| 1978-1983 CJ5, 1978-1986 CJ7, 1981-1986 CJ8, 1987-1990 Wrangler, 1978-1990 Cherokee / Grand Wagoneer (SJ), Ignition Wire Set [For 4.2L] | 17245.09 |
| 1983 CJ5, 1983-1986 CJ7, 1983-1986 CJ8, 1987-1990 Wrangler, 1984-1990 Cherokee, Ignition Wire Set (2.5L AMC) | 17245.05 |
| 1991-2002 Wrangler (2.5L), 1991-2000 Cherokee (2.5L), Ignition Wire Set | 17245.06 |
| 1991-2000 Wrangler (4.0L), 1991-2000 Cherokee (4.0L), 1993-2000 Grand Cherokee (4.0L), Ignition Wire Set | 17245.11 |
| 2003-2006 Wrangler (2.4L), 2002-2005 Liberty (2.4L), Ignition Wire Set | 17245.16 |
| 2007-2011 Wrangler (3.8L), Ignition Wire Set NEW | 17245.18 |
| 1984-1986 Cherokee (2.8L), Ignition Wire Set | 17245.15 |
| 1987-1990 Cherokee (4.0L), Ignition Wire Set | 17245.10 |
| 1993-1998 Grand Cherokee (5.2L), 1998 Grand Cherokee (5.9L), Ignition Wire Set | 17245.14 |
| 2005 Grand Cherokee (5.7L), Ignition Wire Set | 17245.17 |

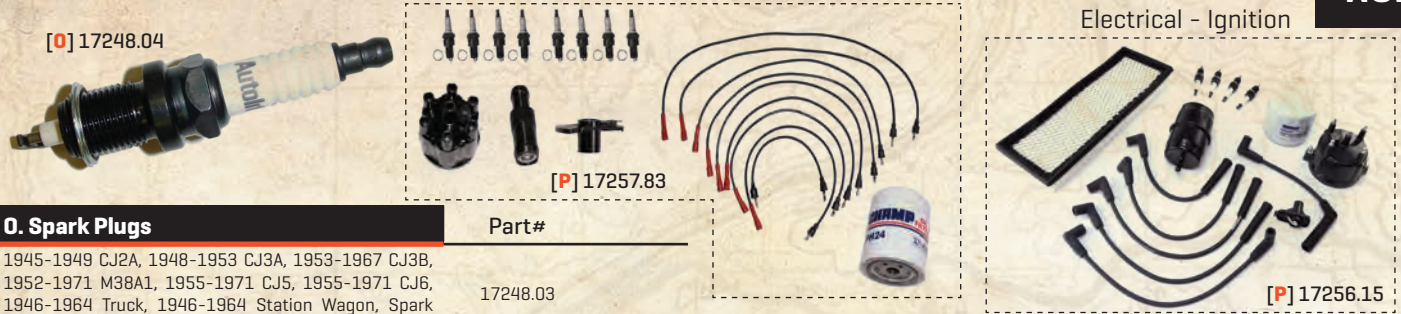

| O. Spark Plugs | Part# |
|--|----------|
| 1945-1949 CJ2A, 1948-1953 CJ3A, 1953-1967 CJ3B, 1952-1971 M38A1, 1955-1971 CJ5, 1955-1971 CJ6, 1946-1964 Truck, 1946-1964 Station Wagon, Spark Plug (Non Resistor, Copper Core) | 17248.03 |
| 1945-1949 CJ2A, 1948-1953 CJ3A, 1953-1967 CJ3B, 1952-1971 M38A1, 1955-1971 CJ5, 1955-1971 CJ6, 1946-1964 Truck, 1946-1964 Station Wagon, Spark Plug (Non Resistor, Copper Core) | RJ8C |
| 1950-1952 M38, 1952-1971 M38A1, Spark Plug (Resistor, Military Shielded Waterproof) * | 17248.01 |
| 1972-1977 CJ5 (3.8L, 4.2L & 5.0L), 1972-1975 CJ6 (3.8L, 4.2L & 5.0L), 1976-1977 CJ7 (3.8L, 4.2L & 5.0L), 1972-1977 Cherokee / Grand Wagoneer (SJ) (4.2L), 1972-1990 Cherokee / Grand Wagoneer (SJ) (5.9L & 6.6L), Distributor Cap (Points Style) | RN14YC |
| 1950-1952 M38, 1952-1971 M38A1, Spark Plug (Resistor, Military Shielded Waterproof) ** | 17248.02 |
| 1978-1979 CJ5 (3.8L & 4.2L), 1978-1979 CJ7 (3.8L & 4.2L), 1978-1987 Cherokee / Grand Wagoneer (SJ) (4.2L, 5.9L & 6.6L), Spark Plug (Non Resistor, Copper Core) | RN13LYC |
| 1954-1964 Truck & Station Wagon (226 CI), Spark Plug | 17248.03 |
| 1980-1983 CJ5 (2.5L GM), 1980-1983 CJ7 (2.5L GM), 1981-1983 CJ8 (2.5L GM), Spark Plug (Resistor, Copper Core) | RV17YC6 |
| 1972-1977 CJ5 (3.8L, 4.2L & 5.0L), 1972-1975 CJ6 (3.8L, 4.2L & 5.0L), 1976-1977 CJ7 (3.8L, 4.2L & 5.0L), 1972-1977 Cherokee / Grand Wagoneer (SJ) (4.2L), 1972-1990 Cherokee / Grand Wagoneer (SJ) (5.9L & 6.6L), Distributor Cap (Points Style) | 17248.05 |
| 1980-1983 CJ5 (4.2L), 1983 CJ5 (2.5L AMC), 1980-1986 CJ7 (4.2L), 1983-1986 CJ7 (2.5L AMC), 1981-1986 CJ8 (4.2L), 1983-1986 CJ8 (2.5L AMC), 1987-1990 Wrangler (2.5L & 4.0L), 1984-1985 Cherokee (2.5L), 1978-1987 Cherokee / Grand Wagoneer (SJ) (4.2L, 5.9L & 6.6L), Spark Plug (Resistor, Copper Core) | RFN14LY |
| 1978-1979 CJ5 (3.8L & 4.2L), 1978-1979 CJ7 (3.8L & 4.2L), 1978-1987 Cherokee / Grand Wagoneer (SJ) (4.2L, 5.9L & 6.6L), Spark Plug (Non Resistor, Copper Core) | 17248.06 |
| 1987-1998 Wrangler (2.5L), 1991-1998 Wrangler (4.0L), 1986-1998 Cherokee (2.5L), 1991-1998 Cherokee (4.0L), 1993-1998 Grand Cherokee (4.0L), Spark Plug (Resistor, Copper Core) | RC12LYC |
| 1980-1983 CJ5 (4.2L), 1983 CJ5 (2.5L AMC), 1980-1986 CJ7 (4.2L), 1983-1986 CJ7 (2.5L AMC), 1981-1986 CJ8 (4.2L), 1983-1986 CJ8 (2.5L AMC), 1987-1990 Wrangler (2.5L & 4.0L), 1984-1987 Cherokee (2.5L), 1978-1987 Cherokee / Grand Wagoneer (SJ) (4.2L, 5.9L & 6.6L), Spark Plug (Resistor, Copper Core) | 17248.04 |
| 1999-2002 Wrangler (2.5L), 1999-2006 Wrangler (4.0L), 1999-2000 Cherokee (2.5L), 1999-2001 Cherokee (4.0L), 1999-2004 Grand Cherokee (4.0L), Spark Plug (Resistor, Copper Core) | RC12ECC |
| 2003-2006 Wrangler (2.4L), 2002-2005 Liberty (2.4L), Spark Plug (Resistor, Copper Core) | RE14MCC5 |
| 2007-2011 Wrangler (3.8L), Spark Plug (Resistor, Platinum) | RE14PLP5 |
| 1984-1986 Cherokee (2.8L), 1993-1996 Grand Cherokee (5.2L), Spark Plug (Resistor, Copper Core) • | RV12YC |
| 1984-1986 Cherokee (2.8L), 1993-1996 Grand Cherokee (5.2L), Spark Plug (Resistor, Copper Core) NEW •• | RN12YC |
| 1987-1990 Cherokee (4.0L), 2002-2004 Liberty (3.7L), Spark Plug (Resistor, Copper Core) | RC9YC |
| 1997-1998 Grand Cherokee (5.2L), 1998 Grand Cherokee (5.9L), Spark Plug (Resistor, Copper Core) | RC12LC4 |
| 1999-2004 Grand Cherokee (4.7L), Spark Plug (Resistor, Copper Core, Heat Range 7) NEW | RC7YC |
| 1999-2004 Grand Cherokee (4.7L), Spark Plug (Resistor, Copper Core, Heat Range 12) | RC12MCC4 |
| 1999-2004 Grand Cherokee (4.7L), Spark Plug (Resistor, Platinum) NEW | RC7PYCB4 |

* Autolite #2243
 ** Autolite #2245
 • 11.6mm Reach
 •• 19mm Reach

| P. Tune-Up Kits | Part# |
|---|----------|
| 1941-1945 MB, 1941-1945 Ford GPW, Ignition Tune Up Kit (134 CI) | 17257.71 |
| 1945-1949 CJ2A, 1948-1953 CJ3A, Ignition Tune Up Kit (134 CI) | 17257.72 |
| 1953-1967 CJ3B, 1955-1966 CJ5, 1955-1966 CJ6, Ignition Tune Up Kit (134 CI) | 17257.73 |
| 1954-1964 Truck and Station Wagon, Ignition Tune Up Kit (226 CI With Disposable Oil Filter) | 17257.78 |
| 1954-1964 Truck and Station Wagon, Ignition Tune Up Kit (226 CI With Canister Style Oil Filter) | 17257.77 |
| 1964-1971 CJ5, 1964-1971 CJ6, Ignition Tune Up Kit (134 CI) | 17257.74 |
| 1972-1973 CJ5 (3.8L & 4.2L), 1972-1973 CJ6 (3.8L & 4.2L), 1972-1973 Cherokee / Grand Wagoneer (SJ) (4.2L), Ignition Tune Up Kit | 17257.79 |
| 1972-1974 CJ5 (5.0L), 1972-1974 CJ6 (5.0L), 1972-1974 Cherokee / Grand Wagoneer (SJ) (5.9L & 6.6L), Ignition Tune Up Kit (With Points) | 17257.82 |
| 1974 CJ5 (3.8L & 4.2L), 1974 CJ6 (3.8L & 4.2L), 1974 Cherokee / Grand Wagoneer (SJ) (4.2L), Ignition Tune Up Kit | 17257.80 |
| 1975-1977 CJ5 (3.8L & 4.2L), 1975 CJ6 (3.8L & 4.2L), 1976-1977 CJ7 (3.8L & 4.2L), 1975-1977 Cherokee / Grand Wagoneer (SJ) (4.2L) Ignition Tune Up Kit (Prestolite) | 17257.81 |
| 1975-1977 CJ5 (5.0L), 1975 CJ6 (5.0L), 1976-1977 CJ7 (5.0L), 1981 CJ8 (5.0L), Ignition Tune Up Kit (Prestolite) | 17257.83 |
| 1978-1979 CJ5 (3.8L), 1978-1983 CJ5 (4.2L), 1978-1979 CJ7 (3.8L), 1978-1986 CJ7 (4.2L), 1981-1986 CJ8 (4.2L), 1978-1979 Cherokee / Grand Wagoneer (SJ) (4.2L), Ignition Tune Up Kit | 17256.27 |
| 1978-1981 CJ5 (5.0L), 1978-1981 CJ7 (5.0L), 1981 CJ8 (5.0L), Ignition Tune Up Kit | 17256.30 |
| 1980-1982 CJ5 (4.2L), 1980-1982 CJ7 (4.2L), 1980-1982 CJ8 (4.2L), Ignition Tune Up Kit | 17256.28 |
| 1983 CJ5 (2.5L AMC), 1983-1986 CJ7 (2.5L AMC), 1983-1986 CJ8 (2.5L AMC), Ignition Tune Up Kit | 17257.85 |
| 1983 CJ5 (4.2L), 1983-1986 CJ7 (4.2L), 1983-1986 CJ8 (4.2L), Ignition Tune Up Kit | 17256.29 |
| 1987-1990 Wrangler (2.5L), Ignition Tune Up Kit | 17256.12 |
| 1987-1990 Wrangler (4.2L), Ignition Tune Up Kit | 17256.01 |
| 1991-1993 Wrangler (2.5L With Carburetor), Ignition Tune Up Kit | 17256.14 |
| 1991-1993 Wrangler (2.5L With EFI), Ignition Tune Up Kit | 17256.13 |
| 1991-1993 Wrangler (4.0L), Ignition Tune Up Kit | 17256.02 |
| 1994-1995 Wrangler (2.5L), Ignition Tune Up Kit | 17256.15 |
| 1994-1995 Wrangler (4.0L), Ignition Tune Up Kit | 17256.03 |
| 1997-1998 Wrangler (2.5L), Ignition Tune Up Kit | 17256.16 |
| 1997-1998 Wrangler (4.0L), Ignition Tune Up Kit | 17256.04 |
| 1999-2000 Wrangler (2.5L), Ignition Tune Up Kit | 17256.26 |
| 1999-2000 Wrangler (4.0L), Ignition Tune Up Kit | 17256.25 |
| 1987-1990 Cherokee (2.5L), Ignition Tune Up Kit | 17256.17 |
| 1987-1990 Cherokee (4.2L), Ignition Tune Up Kit | 17256.05 |
| 1991-1993 Cherokee (2.5L With Carburetor), Ignition Tune Up Kit | 17256.18 |
| 1991-1993 Cherokee (2.5L With EFI), Ignition Tune Up Kit | 17256.19 |
| 1991-1993 Cherokee (4.0L), Ignition Tune Up Kit | 17256.06 |
| 1994-1996 Cherokee (2.5L), Ignition Tune Up Kit | 17256.20 |
| 1994-1996 Cherokee (4.0L), Ignition Tune Up Kit | 17256.07 |
| 1997-1998 Cherokee (2.5L), Ignition Tune Up Kit | 17256.21 |
| 1997-1998 Cherokee (4.0L), Ignition Tune Up Kit | 17256.08 |
| 1999-2000 Cherokee (2.5L), Ignition Tune Up Kit | 17256.22 |
| 1999-2000 Cherokee (4.0L), Ignition Tune Up Kit | 17256.09 |
| 1994-1996 Grand Cherokee (4.0L), Ignition Tune Up Kit | 17256.10 |
| 1994-1996 Grand Cherokee (5.2L), Ignition Tune Up Kit | 17256.23 |
| 1997-1998 Grand Cherokee (4.0L), Ignition Tune Up Kit | 17256.11 |
| 1997-1998 Grand Cherokee (5.2L), 1998 Grand Cherokee (5.9L) Ignition Tune Up Kit | 17256.24 |
| 1999-2002 Grand Cherokee (4.0L), Ignition Tune Up Kit | 17256.35 |
| 1999-2002 Grand Cherokee (4.7L), Ignition Tune Up Kit | 17256.36 |

Q. Oxygen Sensors

| Part# | Part# |
|----------|----------|
| 17222.01 | 17222.01 |
| 17222.02 | 17222.02 |
| 17222.08 | 17222.08 |
| 17222.04 | 17222.04 |
| 17222.09 | 17222.09 |
| 17222.07 | 17222.07 |
| 17222.06 | 17222.06 |
| 17222.05 | 17222.05 |
| 17222.14 | 17222.14 |
| 17222.15 | 17222.15 |
| 17222.23 | 17222.23 |
| 17222.23 | 17222.23 |
| 17222.18 | 17222.18 |
| 17222.28 | 17222.28 |
| 17222.31 | 17222.31 |
| 17222.36 | 17222.36 |
| 17222.28 | 17222.28 |
| 17222.39 | 17222.39 |
| 17222.37 | 17222.37 |
| 17222.40 | 17222.40 |
| 17222.41 | 17222.41 |
| 17222.03 | 17222.03 |
| 17222.16 | 17222.16 |
| 17222.11 | 17222.11 |
| 17222.10 | 17222.10 |
| 17222.12 | 17222.12 |
| 17222.22 | 17222.22 |
| 17222.19 | 17222.19 |
| 17222.17 | 17222.17 |
| 17222.19 | 17222.19 |
| 17222.24 | 17222.24 |
| 17222.26 | 17222.26 |
| 17222.24 | 17222.24 |
| 17222.32 | 17222.32 |
| 17222.36 | 17222.36 |
| 17222.20 | 17222.20 |
| 17222.32 | 17222.32 |
| 17222.36 | 17222.36 |
| 17222.29 | 17222.29 |
| 17222.25 | 17222.25 |
| 17222.17 | 17222.17 |
| 17222.18 | 17222.18 |
| 17222.37 | 17222.37 |



| Part# | Part# |
|----------|----------|
| 17219.04 | 17219.04 |
| 17219.05 | 17219.05 |
| 17219.15 | 17219.15 |
| 17219.17 | 17219.17 |
| 17219.08 | 17219.08 |
| 17219.01 | 17219.01 |
| 17219.02 | 17219.02 |
| 17219.03 | 17219.03 |
| 17219.06 | 17219.06 |
| 17219.07 | 17219.07 |
| 17219.13 | 17219.13 |
| 17219.12 | 17219.12 |
| 17219.09 | 17219.09 |
| 17219.10 | 17219.10 |
| 17219.11 | 17219.11 |
| 17219.07 | 17219.07 |



OMIX-ADA, Inc.



[S] 17218.05



[T] 17221.01



[U] 17224.02



[W] 17220.03



[V] 17257.02



[Y] 17223.50



[Z] 17223.01

S. Temperature Sensors

| Part# | Part# |
|----------|--|
| 17218.02 | 1972-1983 CJ5 (2.5L, 3.8L, 4.2L & 5.0L), 1976-1986 CJ7 (2.5L, 3.8L, 4.2L & 5.0L), 1981-1986 CJ8 (2.5L, 3.8L, 4.2L & 5.0L), 1972-1985 Cherokee / Grand Wagoneer (SJ) (4.2L, 5.9L, 6.6L), Temperature Sensor |
| 17218.03 | 1987-1990 Wrangler (2.5L & 4.2L), 1986-1991 Cherokee / Grand Wagoneer (SJ) (4.2L, 5.9L, 6.6L), 1987-1990 Cherokee (2.1L & 2.5L), Temperature Sending Unit (With Temp Gauge) |
| 17218.04 | 1992-1995 Wrangler (2.5L & 4.2L), Temperature Sensor (With Temp Gauge) |
| 17217.01 | 1988-1990 Wrangler (4.2L) 1991-1995 Wrangler (2.5L), 1991-1997 Wrangler (4.0L), 1991-1996 Cherokee (2.5L & 4.0L), Temperature Sending Unit* |
| 17218.06 | 1997-2006 Wrangler (2.4L, 2.5L & 4.0L), 1997-2001 Cherokee (2.5L & 4.0L), 1997-2004 (4.0L & 4.7L) Grand Cherokee, 2002-2007 Liberty, Temperature Sensor |
| 17217.03 | 1984-1990 Cherokee (2.5L & 4.0L), Temperature Sensor |
| 17218.05 | 1992-1996 Cherokee (2.5L & 4.0L), 1993-1996 Grand Cherokee (4.0L), 1994-1995 Wrangler (2.5L & 4.0L), Temperature Sensor (With Warning Light)** |
| 17217.02 | 1993-1998 Grand Cherokee (5.2L), 1996-Grand Cherokee (4.0L), 1998 Grand Cherokee (5.9L), Temperature Sending Unit (With Temp Gauge) |

* Without Temperature Gauge
 ** Located in Cylinder Head

T. Intake Temperature Sensors

| Part# | Part# |
|----------|--|
| 17221.01 | 1990-1995 Wrangler (4.0L), 1991-1995 Wrangler (2.5L), 1991-1996 Cherokee (2.5L & 4.0L), Intake Temperature Sensor |
| 17221.02 | 1997-2002 Wrangler (2.5L), 1997-2005 Wrangler (4.0L), 1997-2000 Cherokee (2.5L), 1997-2001 Cherokee (4.0L), 1997-2004 Grand Cherokee (4.0L), Intake Temperature Sensor |
| 17221.03 | 2003-2006 Wrangler (2.4L), 2006 Wrangler (4.0L), 2001-2004 Grand Cherokee (4.7L), 2005-2010 Grand Cherokee (3.7L), 2003-2004 Liberty (3.7L), Intake Temperature Sensor |

U. Throttle Position Sensors

| Part# | Part# |
|----------|---|
| 17224.01 | 1987-1990 Wrangler (2.5L), 1986-1990 Cherokee (2.5L), Throttle Position Sensor |
| 17224.02 | 1990-1995 Wrangler (4.0L), 1991-1995 Wrangler (2.5L), 1991-1996 Cherokee (2.5L & 4.0L), 1993-1996 Grand Cherokee (4.0L & 5.2L), Throttle Position Sensor |
| 17224.04 | 1997-2001 Wrangler (2.5L & 4.0L), 1997-2000 Cherokee (2.5L), 1997-2001 Cherokee (4.0L), 1997-2001 Grand Cherokee (4.0L), Throttle Position Sensor NEW |
| 17224.06 | 2002-2006 Wrangler (4.0L), 2003-2006 Wrangler (2.4L), 2002-2004 Grand Cherokee (4.0L), 2005-2006 Grand Cherokee (3.7L), 2002-2005 Liberty (2.4L), 2002-2006 Liberty (3.7L), Throttle Position Sensor NEW |
| 17224.03 | 1997-1998 Grand Cherokee (5.2L), 1998 Grand Cherokee (5.9L), Throttle Position Sensor |
| 17224.05 | 1999-2007 Grand Cherokee (4.7), Crankshaft Positions Sensor NEW |

V. Camshaft Position Sensors

| Part# | Part# |
|----------|--|
| 17257.03 | 2003-2006 Wrangler (2.4L), 2002-2005 Liberty (2.4L), Camshaft Sensor |
| 17257.01 | 1999-2004 Grand Cherokee (4.0L), Camshaft Position Sensor |
| 17257.02 | 1999-2004 Grand Cherokee (4.7L), 2005-2007 Grand Cherokee (3.7L, 4.7L & 5.7L), 2002-2007 Liberty (3.7L), Camshaft Position Sensor NEW |

W. Crankshaft Position Sensors

| Part# | Part# |
|----------|---|
| 17220.03 | 1991-1992 Wrangler (2.5L & 4.0L), 1991-1992 Cherokee (2.5L & 4.0L), Crankshaft Position Sensor NEW |
| 17220.02 | 1993-1995 Wrangler (2.5L With AT or MT), 1993-1995 Wrangler (4.0L With MT), 1993-1996 Cherokee (4.0L), Crankshaft Positions Sensor NEW |
| 17220.07 | 1993-1995 Wrangler (4.0L), 1994-1996 Grand Cherokee (4.0L), Crankshaft Positions Sensor (With Automatic Transmission) NEW |
| 17220.13 | 1997-2002 Wrangler (2.5L With MT or AT), 1997-2004 Wrangler (4.0L With MT), 1997-2000 Cherokee (2.5L), Crankshaft Position Sensor NEW |
| 17220.05 | 1997-2002 Wrangler (4.0L), 1997-2004 Grand Cherokee (4.0L), Crankshaft Positions Sensor (With Automatic Transmission) NEW |
| 17220.04 | 2003-2006 Wrangler (4.0L With AT), 2009-2011 Wrangler (3.8L with MT), Crankshaft Position Sensor NEW |
| 17220.12 | 1997-2001 Cherokee (4.0L), Crankshaft Position Sensor |
| 17220.01 | 1994-1996 Grand Cherokee (5.2L), Crankshaft Position Sensor |
| 17220.14 | 1997-1998 Grand Cherokee (5.2L), 1998 Grand Cherokee (5.9L), Crankshaft Position Sensor |
| 17220.08 | 1999-2009 Grand Cherokee (4.7L), Crankshaft Position Sensor NEW |
| 17220.10 | 2002-2004 Liberty (2.4L), Crankshaft Positions Sensor NEW |
| 17220.09 | 2002-2003 Liberty (3.7), Crankshaft Position Sensor |
| 17220.11 | 2004-2007 Liberty (3.7), Crankshaft Position Sensor NEW |

Y. Knock Sensors

| Part# | Part# |
|----------|--|
| 17223.50 | 1990-1995 Wrangler (4.0L), 1996-1996 Cherokee (4.0L), 1993-1996 Grand Cherokee (4.0L), Knock Sensor NEW |
| 17223.51 | 2003-2007 Grand Cherokee (4.7L), Knock Sensor |
| 17223.52 | 2007-2011 Wrangler (3.8L), 2007-2011 Compass (2.0L, 2.4L & 3.5L), 2007-2011 Patriot (2.0L, 2.4L & 3.5L), 2005-2010 Grand Cherokee (5.7L), 2006-2010 Grand Cherokee (6.1L), Knock Sensor NEW |

Z. Map Sensors

| Part# | Part# |
|----------|--|
| 17223.01 | 1987-1995 Wrangler (2.5L, 4.0L & 4.2L), 1986-1995 Cherokee (2.5L), 1987-1995 Cherokee (4.0L), Map Sensor |
| 17223.02 | 1997-2002 Wrangler (2.5L & 4.0L), 1997-2001 Cherokee (2.5L & 4.0L), 1993-1996 Grand Cherokee (4.0L) MAP Sensor |
| 17223.03 | 1993-1996 Grand Cherokee (5.2L), Map Sensor |



OMIX-ADA, Inc.

[Z-1] 17251.01



[Z-3] 17259.04



[Z-4] 13318.05

[Z-5] 17234.03

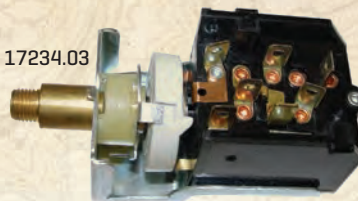

[Z-6] 17234.10



[Z-8] 17233.03



[Z-2] 17250.02

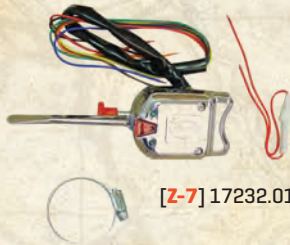

[Z-7] 17232.01

Z-1. Ignition Switches

Part#

| | |
|--|----------|
| 1941-1945 MB, 1941-1945 Ford GPW, 1945-1949 CJ2A, Ignition Switch (Floor Mounted) | 17251.01 |
| 1976-1983 CJ5, 1976-1986 CJ7, 1981-1986 CJ8, 1987-1995 Wrangler, Ignition Switch (Without Tilt Column) | 17251.02 |
| 1976-1983 CJ5, 1976-1986 CJ7, 1981-1986 CJ8, 1987-1995 Wrangler, Ignition Switch (With Tilt Column) | 17251.03 |
| 1997-2000 Wrangler, 1997-2001 Cherokee, Ignition Switch (Without Tilt Colum) | 17251.07 |
| 2001-2006 Wrangler, Ignition Switch | 17251.04 |
| 1993-1996 Grand Cherokee, Ignition Switch | 17251.05 |
| 1997-1998 Grand Cherokee, Ignition Switch | 17251.08 |
| 1999-2004 Grand Cherokee, Ignition Switch NEW | 17251.06 |

Z-2. Ignition Lock Cylinders With Keys

Part#

| | |
|--|----------|
| 1945-1949 CJ2A, 1948-1953 CJ3A, 1953-1967 CJ3B, 1952-1971 M38A1, 1955-1971 CJ5, 1955-1971 CJ6, 1946-1964 Truck, 1946-1964 Station Wagon, Distributor, Ignition Lock Cylinder With Keys | 17250.01 |
| 1967-1972 Jeepster, Ignition Lock Cylinder With Keys | 17250.02 |
| 1976-1983 CJ5, 1976-1986 CJ7, 1981-1986 CJ8, 1987-1995 Wrangler, 1976-1986 Cherokee / Grand Wagoneer (SJ), Ignition Lock Cylinder With Keys | 17250.03 |
| 1987-1990 Wrangler, 1987-1990 Cherokee, Ignition Lock Cylinder With Keys | 17250.04 |
| 1990-1995 Wrangler, 1990-1996 Cherokee, Ignition Lock Cylinder With Keys | 17250.05 |
| 1997-2006 Wrangler, 1997-2001 Cherokee, 1999-2004 Grand Cherokee, 2002-2007 Liberty, Ignition Lock Cylinder With Keys NEW | 17250.09 |
| 1997-1998 Grand Cherokee, Ignition Lock Cylinder With Keys | 17250.08 |

Z-3. ABS Speed Sensors

Part#

| | |
|---|----------|
| 1997-2006 Wrangler, ABS Speed Sensor, Front, LH or RH | 17259.01 |
| 1997-2006 Wrangler, ABS Speed Sensor, Rear, LH | 17259.03 |
| 1997-2006 Wrangler, ABS Speed Sensor, Rear, RH | 17259.02 |
| 1999-2004 Grand Cherokee, ABS Speed Sensor, Rear, LH | 17259.05 |
| 1999-2004 Grand Cherokee, ABS Speed Sensor, Rear, RH | 17259.04 |

Z-4. Headlight Knobs

Part#

| | |
|---|----------|
| 1945-1949 CJ2A, 1948-1953 CJ3A, 1953-1967 CJ3B, 1955-1971 CJ5, 1955-1971 CJ6, Headlight Knob | 17234.02 |
| 1968-1983 CJ5, 1968-1975 CJ6, 1976-1986 CJ7, 1981-1986 CJ8, Heater Switch Knob | 13318.05 |
| 1972-1979 CJ5, 1972-1975 CJ6, 1976-1979 CJ7, 1972-1979 Cherokee / Grand Wagoneer (SJ), Headlight Knob | 13318.06 |

Z-5. Headlight Switches

Part#

| | |
|--|----------|
| 1945-1949 CJ2A, 1948-1953 CJ3A, 1953-1967 CJ3B, 1955-1971 CJ5, 1955-1971 CJ6, Headlight Switch | 17234.01 |
| 1945-1949 CJ2A, 1948-1953 CJ3A, 1953-1967 CJ3B, 1955-1983 CJ5, 1955-1975 CJ6, 1976-1986 CJ7, 1981-1986 CJ8, Headlight Switch Nut | 17234.11 |
| 1945-1949 CJ2A, 1948-1953 CJ3A, 1953-1967 CJ3B, 1955-1983 CJ5, 1955-1975 CJ6, 1976-1986 CJ7, 1981-1986 CJ8, Headlight Switch Bezel | 17234.12 |
| 1972-1979 CJ5, 1972-1975 CJ6, 1976-1979 CJ7, 1972-1979 Cherokee / Grand Wagoneer (SJ), Headlight Switch | 17234.03 |
| 1979-1983 CJ5, 1979-1986 CJ7, 1981-1983 CJ8, 1979-1985 Cherokee / Grand Wagoneer (SJ), Headlight Switch | 17234.04 |
| 1987-1995 Wrangler, Headlight Switch | 17234.05 |
| 1997-1999 Wrangler, 1997-2000 Cherokee, Headlight Switch | 17234.06 |
| 1984-1991 Cherokee, Headlight Switch | 17234.08 |
| 1992-1996 Cherokee, Headlight Switch | 17234.09 |
| 1986-1991 Cherokee / Grand Wagoneer (SJ), Headlight Switch | 17234.07 |

*With Brass Terminal Connector

Z-6. Multifunction Switches

Part#

| | |
|---|----------|
| 1997-2000 Wrangler, Multi Function Switch | 17234.16 |
| 2001-2006 Wrangler, Multi Function Switch (Without Fog Lights) NEW | 17234.17 |
| 2001-2006 Wrangler, Multi Function Switch (With Fog Lights) NEW | 17234.19 |
| 1993-1998 Grand Cherokee, Multi Function Switch | 17234.10 |
| 1993-1998 Grand Cherokee, Multi Function Switch (With Auto Leveling Headlights, Without Fog Lights) | 17234.18 |
| 2002-2005 Liberty, Multi Function Switch (Without Fog Lights) | 17234.14 |
| 2002-2005 Liberty, Multi Function Switch (With Fog Lights) | 17234.15 |

Z-7. Turn Signal Switches & Cancel Cams

Part#

| | |
|--|----------|
| 1941-1945 MB, 1941-1945 Ford GPW, 1945-1949 CJ2A, 1948-1953 CJ3A, 1953-1967 CJ3B, 1955-1971 CJ5, 1955-1971 CJ6, 1946-1964 Truck, 1946-1964 Station Wagon, Turn Signal Switch** | 17232.01 |
| 1976-1983 CJ5, 1976-1986 CJ7, 1981-1986 CJ8, Turn Signal Lever | 13318.07 |
| 1976-1983 CJ5, 1976-1986 CJ7, 1981-1986 CJ8, 1987-1995, Turn Signal Cancel Cam (With Tilt Column) | 17232.04 |
| 1976-1983 CJ5, 1976-1986 CJ7, 1981-1986 CJ8, 1987-1995, 1984-1993 Cherokee, Turn Signal Cancel Cam (Without Tilt Column) | 17232.02 |
| 1994-1995 Wrangler, 1994-1996 Cherokee, Turn Signal Switch (Without Tilt Column) | 17232.05 |

** Column Mounted Universal Style

Z-8. Dimmer Switches

Part#

| | |
|---|----------|
| 1945-1949 CJ2A, 1948-1953 CJ3A, 1953-1967 CJ3B, 1955-1971 CJ5, 1955-1971 CJ6, Headlight Dimmer Switch | 17233.01 |
| 1972-1983 CJ5, 1972-1975 CJ6, 1976-1986 CJ7, 1981-1986 CJ8, 1987-1995, Headlight Dimmer Switch | 17233.02 |
| 1987-1989 Wrangler, 1984-1888 Cherokee, Headlight Dimmer Switch | 17233.03 |
| 1990-1995 Wrangler, 1989-1996 Cherokee, Headlight Dimmer Switch | 17233.04 |



[Z-9] 17238.02



[Z-10] 12411.01



[Z-11] 17231.02

[Z-12] 17237.01



[Z-12] 17237.02



[Z-17] 17255.05

| Z-9. Brake Light Switches | Part# |
|--|----------|
| 1941-1945 MB, 1941-1945 Ford GPW, 1945-1949 CJ2A, 1948-1953 CJ3A, 1953-1967 CJ3B, 1952-1971 M38A1, 1955-1966 CJ5, 1955-1966 CJ6, 1946-1964 Truck, 1946-1964 Station Wagon, 1948-1951 Jeepster, Brake Light Switch* | 17238.01 |
| 1966-1972 CJ5, 1966-1972 CJ6, 1967-1972 Jeepster, Brake Light Switch** | 17238.02 |
| 1973-1983 CJ5, 1976-1986 CJ7, 1981-1986 CJ8, 1987-1990 Wrangler, 1986-1991 Cherokee, 1974-1986 Cherokee / Grand Wagoneer (SJ), Brake Light Switch (Without Cruise Control) | 17238.06 |
| 1987-1990 Wrangler, 1984-1991 Cherokee, Brake Light Switch (With Cruise Control) | 17238.03 |
| 1987-1990 Wrangler, 1984-1990 Cherokee, Brake Switch (Without Cruise Control) | 17238.09 |
| 1991-1995 Wrangler, Brake Light Switch (With Cruise Control) | 17238.07 |
| 1997-2006 Wrangler, 2007-2011 Wrangler, 1992-2001 Cherokee, 1993-2004 Grand Cherokee, Brake Light Switch NEW | 17238.04 |
| 2002 Liberty, Brake Light Switch | 17238.08 |
| 2003-2011 Liberty, Brake Light Switch NEW | 17238.05 |

* With Female Terminal Post

** With Blade Terminals

| Z-10. Flashers | Part# |
|--|----------|
| 1976-1983 CJ5, 1976-1986 CJ7, 1981-1986 CJ8, 1984-1986 Cherokee, 1993 Grand Cherokee, 1974-1991 Cherokee / Grand Wagoneer (SJ), Flasher Relay [2 Blade #552] | 12411.01 |
| 1976-1983 CJ5, 1976-1986 CJ7, 1981-1986 CJ8, 1984-1986 Cherokee, 1993 Grand Cherokee, 1974-1991 Cherokee / Grand Wagoneer (SJ), Flasher Relay [2 Blade #224] | 12411.02 |
| 1987-1995 Wrangler, 1984-1996 Cherokee, Flash [3 Blade #550] | 12411.03 |

| Z-11. Voltage Regulators | Part# |
|--|----------|
| 1941-1945 MB, 1941-1945 Ford GPW, Voltage Regulator [6V] | 17231.06 |
| 1945-1949 CJ2A, 1948-1953 CJ3A, 1953-1958 CJ3B, 1955-1958 CJ5, 1955-1958 CJ6, 1946-1958 Truck, 1946-1958 Station Wagon, 1948-1951 Jeepster, Voltage Regulator [6V] | 17231.02 |
| 1941-1945 MB, 1941-1945 Ford GPW, 1945-1949 CJ2A, 1948-1953 CJ3A, 1953-1967 CJ3B, 1952-1971 M38A1, 1955-1971 CJ5, 1955-1971 CJ6, 1946-1964 Truck, 1946-1964 Station Wagon, 1948-1951 Jeepster, Voltage Regulator [12V] | 17231.03 |

| Z-12. Misc Switches | Part# |
|---|----------|
| 1997-2000 Wrangler, 2001 Cherokee, Fog Light Switch | 17234.21 |
| 1987-1992 Wrangler, Relay For Fog Lamp, Headlight, Rear Wiper & Power Lock [#AR 502-R] | 17237.02 |
| 1994-2001 Cherokee, Door Ajar Switch | 17237.01 |
| 1999-2010 Grand Cherokee, Glove Box Light Switch | 17237.03 |
| 1992-1995 Wrangler, Rear Defrost Switch (With Hardtop) | 17237.05 |
| 1987-1993 Wrangler, 1979-1981 Cherokee / Grand Wagoneer (SJ), Horn Relay NEW | 17249.03 |
| 1993-2011 Wrangler, 1993-2001 Cherokee, 1993-2004 Grand Cherokee, Relay Various Positions [5 Blade] | 17237.07 |
| 1993-2006 Wrangler, 1993-1998 Cherokee, 1993-1998 Grand Cherokee, Starter Relay NEW | 17237.15 |
| Circuit Breaker 5 AMP 94-96 NEW | 17237.14 |
| 1994-1996 Cherokee, 1994-1996 Grand Cherokee, Circuit Breaker [30 Amp] NEW | 17237.10 |

| Z-13. Neutral Safety Switch | Part# |
|---|----------|
| 2007-2011 Wrangler (Automatic Transmission), Neutral Safety Switch NEW | 17261.01 |

| Z-14. Tire Pressure Monitors | Part# |
|--|----------|
| 2007-2011 Wrangler, Tire Pressure Monitor [TPM] Service Kit NEW | 17237.11 |
| 2007-2011 Wrangler, Tire Pressure Monitor [TPM] Sensor NEW | 17237.13 |

| Z-15. Ambient Temperature Sensor | Part# |
|--|----------|
| 1999-2011 Grand Cherokee, 2006-2010 Commander, Ambient Temperature Sensor NEW | 17237.08 |

| Z-16. Wiring Harnesses | Part# |
|--|----------|
| 1945-1946 CJ2A, Complete Wiring Harness (Horn on Firewall, Without Turn Signals) | 17201.01 |
| 1947-1949 CJ2A, Complete Wiring Harness (Horn on Firewall, With Turn Signals) | 17201.02 |
| 1946-1949 CJ2A, Complete Wiring Harness (Horn on Fender, Without Turn Signals) | 17201.03 |
| 1946-1949 CJ2A, Complete Wiring Harness (Horn on Fender, With Turn Signals) | 17201.04 |
| 1948-1953 CJ3A, Complete Wiring Harness (Without Turn Signals) | 17201.05 |
| 1948-1953 CJ3A, Complete Wiring Harness (With Turn Signals) | 17201.06 |
| 1953-1956 CJ3, Complete Wiring Harness (With Early Small Speedometer & Cloth Wire Cover) | 17201.07 |
| 1953-1956 CJ3, Complete Wiring Harness (With Late Larger Speedometer & Plastic Wire Cover) | 17201.08 |
| 1955-1956 CJ5, Complete Wiring Harness (With Cloth Wire Cover) | 17201.09 |
| 1955-1956 CJ5, Complete Wiring Harness (With Plastic Wire Cover) | 17201.10 |

| Z-17. Fuses | Part# |
|-------------------------------|----------|
| 3 Amp, Mini Fuse | 17255.06 |
| 5 Amp, Mini Fuse | 17255.01 |
| 7.5 Amp, Mini Fuse NEW | 17255.07 |
| 10 Amp, Mini Fuse | 17255.02 |
| 15 Amp, Mini Fuse | 17255.03 |
| 20 Amp, Mini Fuse | 17255.04 |
| 30 Amp, Mini Fuse | 17255.05 |
| 20 Amp, Maxi Fuse | 17254.01 |
| 30 Amp, Maxi Fuse | 17254.02 |
| 40 Amp, Maxi Fuse | 17254.03 |
| 50 Amp, Maxi Fuse | 17254.04 |
| 60 Amp, Maxi Fuse | 17254.05 |
| 5 Amp, ATO Fuse | 17253.01 |
| 7.5 Amp, ATO Fuse | 17253.02 |
| 10 Amp, ATO Fuse | 17253.03 |
| 15 Amp, ATO Fuse | 17253.04 |
| 20 Amp, ATO Fuse | 17253.05 |
| 25 Amp, ATO Fuse | 17253.06 |
| 30 Amp, ATO Fuse | 17253.07 |

Electrical - Gauges

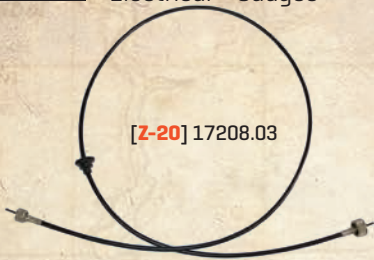

[Z-20] 17208.03



[Z-21] 17215.02



[Z-18] 17206.01



[Z-23] 17210.05



[Z-25] 17210.01



[Z-24] 17210.02



[Z-22] 17210.06



[Z-18] 17206.04



[Z-18] 17205.03

[Z-26] 17215.01

Z-18. Speedometer Assemblies

Part#

| | |
|---|----------|
| 1941-1943 MB & Ford GPW, Speedometer Assembly [0-60 MPH] [Long Style Needle] | 17206.02 |
| 1944-1945 MB & Ford GPW, 1950-1952 M38, 1952-1971 M38A1, Speedometer Assembly [0-60 MPH] [Short Style Needle] | 17206.03 |
| 1945-1949 CJ2A, 1948-1953 CJ3A, 1953-1958 CJ3B, Speedometer Assembly [0-60 MPH] | 17206.01 |
| 1955-1979 CJ5, 1955-1979 CJ6, 1959-1967 CJ3B, 1976-1979 CJ7, Speedometer Assembly [0-90 MPH] NEW | 17206.04 |
| 1980-1983 CJ5, 1980-1986 CJ7, 1981-1986 CJ8, Speedometer Assembly [5-85 MPH] NEW | 17206.05 |
| 1987-1991 Wrangler, Speedometer [0-100 MPH] NEW | 17206.10 |
| 1955-1979 CJ5, 1955-1979 CJ6, 1959-1967 CJ3B, 1976-1979 CJ7, Speedometer Assembly [0-140 KPH] NEW | 17205.02 |
| 1980-1983 CJ5, 1980-1986 CJ7, 1981-1986 CJ8, Speedometer Assembly [0-140 KPH] NEW | 17205.03 |

Z-19. Speedometer Gauge

Part#

| | |
|--|----------|
| 1955-1979 CJ5, 1955-1979 CJ6, 1959-1967 CJ3B, 1976-1979 CJ7, Speedometer Gauge [0-90 MPH] | 17207.01 |
| 1980-1983 CJ5, 1980-1986 CJ7, 1981-1986 CJ8, Speedometer Gauge [5-85 MPH] | 17207.03 |
| 1992-1995 Wrangler, Speedometer [0-100 MPH] NEW | 17206.11 |
| 1955-1979 CJ5, 1955-1979 CJ6, 1959-1967 CJ3B, 1976-1979 CJ7, Speedometer Gauge [0-140 KPH] | 17207.02 |
| 1980-1983 CJ5, 1980-1986 CJ7, 1981-1986 CJ8, Speedometer Gauge [0-140 KPH] | 17207.04 |

Z-20. Speedometer Cables

Part#

| | |
|---|----------|
| 1941-1945 MB, 1941-1945 Ford GPW, 1945-1949 CJ2A, 1948-1953 CJ3A, 1953-1967 CJ3B, 1952-1971 M38A1, 1955-1975 CJ5, 1955-1975 CJ6, Speedometer Cable [60"], [With 3 Speed Transmission] | 17208.01 |
| 1941-1945 MB, 1941-1945 Ford GPW, 1945-1949 CJ2A, 1948-1953 CJ3A, 1953-1967 CJ3B, 1952-1971 M38A1, 1955-1971 CJ5, 1955-1971 CJ6, 1946-1964 Truck, 1946-1964 Station Wagon, Speedometer Driven Gear [With Dana 18 Transfer Case] | 17211.01 |
| 1963-1975 CJ5, 1963-1975 CJ6, Speedometer Cable [67"], [With 4 Speed Transmission] | 17208.02 |
| 1976-1979 CJ5, 1976-1979 CJ7, Speedometer Cable [69"], [With Automatic Transmission] | 17208.04 |
| 1977-1983 CJ5, 1977-1986 CJ7, 1981-1986 CJ8, Speedometer Cable [69"], [With Manual Transmission] | 17208.03 |

Z-21. Tachometer Gauges

Part#

| | |
|---|----------|
| 1976-1983 CJ5, 1976-1986 CJ7, 1981-1986 CJ8, Tachometer [0-6000 RPM], [All Engines] | 17215.02 |
| 1987-1991 Wrangler, Tachometer [2.5L] NEW | 17215.10 |
| 1987-1991 Wrangler, Tachometer [4.0L & 4.2L] NEW | 17215.11 |
| 1992-1995 Wrangler, Tachometer [2.5L & 4.0L] NEW | 17215.12 |



[Z-27] 17237.04



OMIX-ADA, Inc.



[Z-23] 17209.01



Z-22. Fuel Gauges

Part#

| | |
|---|----------|
| 1941-1945 MB, 1941-1945 GPW, 1948-1949 CJ2A, 1948-1953 CJ3A, 1953-1967 CJ3B, Fuel Gauge [For 6V Systems] | 17210.06 |
| 1941-1945 MB, 1941-1945 GPW, 1948-1949 CJ2A, 1948-1953 CJ3A, 1953-1967 CJ3B, Fuel Gauge [For 12V Systems] | 17210.07 |
| 1955-1983 CJ5, 1955-1975 CJ6, 1976-1986 CJ7, 1981-1986 CJ8, Fuel Gauge NEW | 17209.04 |
| 1955-1983 CJ5, 1955-1975 CJ6, 1976-1986 CJ7, 1981-1986 CJ8, Fuel and Temperature Gauge Set NEW | 17209.01 |
| 1987-1991 Wrangler, Fuel Gauge NEW | 17210.10 |
| 1992-1995 Wrangler, Fuel Gauge NEW | 17210.13 |

Z-23. Temperature Gauges

Part#

| | |
|---|----------|
| 1941-1945 MB, 1941-1945 Ford GPW, 1945-1947 CJ2A, Temperature Gauge | 17210.04 |
| 1948-1949 CJ2A, 1948-1953 CJ3A, 1953-1967 CJ3B, Temperature Gauge | 17210.05 |
| 1955-1983 CJ5, 1955-1975 CJ6, 1976-1986 CJ7, 1981-1986 CJ8, Temperature Gauge NEW | 17209.05 |
| 1955-1983 CJ5, 1955-1975 CJ6, 1976-1986 CJ7, 1981-1986 CJ8, Fuel and Temperature Gauge Set NEW | 17209.01 |
| 1987-1991 Wrangler, Temperature Gauge [In Gauge Cluster] NEW | 17210.15 |
| 1992-1995 Wrangler, Temperature Gauge [In Gauge Cluster] NEW | 17210.18 |

Z-24. Oil Gauges

Part#

| | |
|---|----------|
| 1941-1945 MB, 1941-1945 Ford GPW, 1945-1947 CJ2A, Oil Gauge | 17210.02 |
| 1948-1949 CJ2A, 1948-1953 CJ3A, 1953-1967 CJ3B, Oil Gauge | 17210.03 |
| 1976-1983 CJ5, 1976-1986 CJ7, 1981-1986 CJ8, Oil Gauge | 17215.04 |
| 1987-1991 Wrangler, Oil Gauge [In Gauge Cluster] NEW | 17210.16 |
| 1992-1995 Wrangler, Oil Gauge [In Gauge Cluster] NEW | 17210.17 |



[Z-28] 17214.02



[Z-30] 11214.53



OMIX-ADA, Inc.



[Z-29] 17249.02



[Z-30] 11214.01



[Z-30] 17265.01

| Z-25. Ammeters / Volt Gauges | Part# |
|---|----------|
| 1941-1945 MB, 1941-1945 Ford GPW, 1945-1949 CJ2A, 1948-1953 CJ3A, 1953-1967 CJ3B, Ammeter Gauge | 17210.01 |
| 1976-1983 CJ5, 1976-1986 CJ7, 1981-1986 CJ8, Voltmeter | 17215.03 |
| 1987-1991 Wrangler, Voltmeter Gauge (In Gauge Cluster) NEW | 17210.12 |
| 1992-1995 Wrangler, Voltmeter Gauge (In Gauge Cluster) NEW | 17210.14 |

| Z-26. Clocks | Part# |
|---|----------|
| 1976-1983 CJ5, 1976-1986 CJ7, 1981-1986 CJ8, Clock | 17215.01 |
| 1987-1991 Wrangler, Clock (In Gauge Cluster) NEW | 17210.11 |

| Z-27. Misc Gauge Parts | Part# |
|---|----------|
| 1987-1995 Wrangler, Instrument Panel Light Socket | 17237.04 |
| 1987-1991 Wrangler, Gauge Cluster Lens NEW | 17210.80 |
| 1987-1991 Wrangler, Gauge Cluster Circuit Board NEW | 17210.90 |
| 1992-1995 Wrangler, Speedometer and Tachometer Lens NEW | 17210.82 |
| 1992-1995 Wrangler, Speedometer and Tachometer Circuit Board NEW | 17210.92 |
| 1992-1995 Wrangler, Gauge Cluster Lens NEW | 17210.81 |
| 1992-1995 Wrangler, Gauge Cluster Circuit Board NEW | 17210.91 |

| Z-28. Antennas | Part# |
|--|----------|
| 1976-1983 CJ5, 1976-1986 CJ7, 1981-1986 CJ8, 1987-1995 Wrangler, Antenna Kit, Black | 17214.02 |
| 1976-1983 CJ5, 1976-1986 CJ7, 1981-1986 CJ8, 1987-1995 Wrangler, Antenna Kit, Chrome | 17214.01 |

| Z-29. Replacement Horns | Part# |
|--|----------|
| 1976-1983 CJ5, 1976-1986 CJ7, 1981-1986 CJ8, 1987-1995 Wrangler, Horn (Low Pitch) | 17249.01 |
| 1976-1983 CJ5, 1976-1986 CJ7, 1981-1986 CJ8, 1987-1995 Wrangler, Horn (High Pitch) | 17249.02 |

| Z-30. Battery Tray Kits | Part# |
|---|----------|
| 1976-1983 CJ5, 1976-1986 CJ7, 1981-1986 CJ8, Battery Tray Kit, Black | 11214.01 |
| 1976-1983 CJ5, 1976-1986 CJ7, 1981-1986 CJ8, Battery Tray Kit, Stainless Steel | 11132.01 |
| 1970-1983 CJ5, 1970-1975 CJ6, 1976-1986 CJ7, 1981-1986 CJ8, 1987-1990 Wrangler, Dual Battery Tray Kit UPGRADE | 11214.50 |
| 1991-1995 Wrangler, Dual Battery Tray Kit UPGRADE | 11214.51 |
| 1997-2006 Wrangler, Dual Battery Tray Kit UPGRADE | 11214.52 |
| 2007-2011 Wrangler, Dual Battery Tray Kit UPGRADE | 11214.53 |
| 1970-1983 CJ5, 1970-1975 CJ6, 1976-1986 CJ7, 1981-1986 CJ8, 1987-2011 Wrangler, Dual Battery Relay UPGRADE-NEW | 17265.01 |



[A] DMC-6914



[C] 17402.02



[D] 17403.01



[E] 17738.01



A. Aluminum Valve Covers

| | Part# |
|--|----------|
| 1972-1981 CJ5 (5.0L), 1972-1976 CJ6 (5.0L), 1976-1981 CJ7 (5.0L), 1981 CJ8 (5.0L), 1972-1991 Cherokee / Grand Wagoneer (5.0L, 5.9L, 6.6L), Valve Cover, Die Cast Aluminum, Black Wrinkle Finish [With Jeep Script] | DMC-6920 |
| 1972-1981 CJ5 (5.0L), 1972-1976 CJ6 (5.0L), 1976-1981 CJ7 (5.0L), 1981 CJ8 (5.0L), 1972-1991 Cherokee / Grand Wagoneer (5.0L, 5.9L, 6.6L), Valve Cover, Die Cast Aluminum, Polished Finish [With Blanks for Emblems] | 17401.12 |
| 1972-1981 CJ5 (5.0L), 1972-1976 CJ6 (5.0L), 1976-1981 CJ7 (5.0L), 1981 CJ8 (5.0L), 1972-1991 Cherokee / Grand Wagoneer (5.0L, 5.9L, 6.6L), Valve Cover, Die Cast Aluminum, Black Wrinkle Finish [With Blanks for Emblems] NEW | 17401.13 |
| 1972-1981 CJ5 (5.0L), 1972-1976 CJ6 (5.0L), 1976-1981 CJ7 (5.0L), 1981-1981 CJ8 (5.0L), 1972-1991 Cherokee / Grand Wagoneer (5.0L, 5.9L, 6.6L), Valve Cover [4.2L], Die Cast Aluminum, Polished Finish [With Omix Logo] | 17401.10 |
| 1981-1983 CJ5, 1981-1986 CJ7, 1981-1986 CJ8, 1987 Wrangler, 1981-1987 Cherokee / Grand Cherokee (SJ), Valve Cover [4.2L], Die Cast Aluminum, Black Wrinkle Finish [With Jeep Script] | DMC-6914 |
| 1981-1983 CJ5, 1981-1986 CJ7, 1981-1986 CJ8, 1987 Wrangler, 1981-1987 Cherokee / Grand Cherokee (SJ), Valve Cover [4.2L], Die Cast Aluminum, Black Wrinkle Finish [With 4.2L Script] | 17401.08 |
| 1981-1983 CJ5, 1981-1986 CJ7, 1981-1986 CJ8, 1987 Wrangler, 1981-1987 Cherokee / Grand Cherokee (SJ), Valve Cover [4.2L], Die Cast Aluminum, Polished Finish [With 4.2L Script] | 17401.09 |
| 1981-1983 CJ5, 1981-1986 CJ7, 1981-1986 CJ8, 1987 Wrangler, 1981-1987 Cherokee / Grand Cherokee (SJ), Valve Cover [4.2L], Die Cast Aluminum, Blue Finish [With 4.2L Script] | 17401.11 |
| 1981-1983 CJ5, 1981-1986 CJ7, 1981-1986 CJ8, 1987 Wrangler, 1981-1987 Cherokee / Grand Cherokee (SJ), Valve Cover [4.2L], Die Cast Aluminum, Red Finish [With 4.2L Script] | 17401.14 |
| 1981-1983 CJ5, 1981-1986 CJ7, 1981-1986 CJ8, 1987 Wrangler, 1981-1987 Cherokee / Grand Cherokee (SJ), Valve Cover [4.2L], Die Cast Aluminum, Black Wrinkle Finish [With 258 Script] | 17401.15 |
| 1981-1983 CJ5, 1981-1986 CJ7, 1981-1986 CJ8, 1987 Wrangler, 1981-1987 Cherokee / Grand Cherokee (SJ), Valve Cover [4.2L], Die Cast Aluminum, Black Wrinkle Finish [With Omix Logo] | 17401.07 |
| 1981-1983 CJ5, 1981-1986 CJ7, 1981-1986 CJ8, 1987 Wrangler, 1981-1987 Cherokee / Grand Cherokee (SJ), Rocker Arm Bridge [For 4.2L With Aluminum Valve Cover], 2 Required | 17408.11 |
| 1981-1983 CJ5, 1981-1986 CJ7, 1981-1986 CJ8, 1987 Wrangler, 1981-1987 Cherokee / Grand Cherokee (SJ), Rocker Arm Bridge [For 4.2L With Aluminum Valve Cover], 2 Required | 17402.01 |

B. Plastic Valve Covers

| | Part# |
|---|----------|
| 1981-1983 CJ5, 1981-1986 CJ7, 1981-1986 CJ8, 1987 Wrangler, 1981-1987 Cherokee / Grand Cherokee (SJ), Valve Cover [4.2L], Plastic | 17401.03 |
| 1981-1983 CJ5, 1981-1986 CJ7, 1981-1986 CJ8, 1987 Wrangler, 1981-1987 Cherokee / Grand Cherokee (SJ), Valve Cover Kit [4.2L], Plastic, Includes Valve Cover, Gasket [Cork] & Hardware | 17401.04 |
| 1981-1983 CJ5, 1981-1986 CJ7, 1981-1986 CJ8, 1987 Wrangler, 1981-1987 Cherokee / Grand Cherokee (SJ), Valve Cover Kit [4.2L], Plastic, Includes Valve Cover, Gasket [Rubber] & Hardware [SJ], Valve Cover Kit [4.2L], Plastic, Includes Valve Cover, Gasket [Rubber], Rocker Arm Bridges & Hardware | 17401.05 |
| 1983 CJ5, 1983-1986 CJ7, 1983-1986 CJ8, 1987-1993 Wrangler, Valve Cover [2.5L AMC With Carb], Plastic | 17401.01 |

C. Valve Cover Grommets

| | Part# |
|---|----------|
| 1972-1981 CJ5 (5.0L), 1972-1976 CJ6 (5.0L), 1976-1981 CJ7 (5.0L), 1981-1981 CJ8 (5.0L), 1972-1991 Cherokee / Grand Wagoneer (5.0L, 5.9L, 6.6L), Valve Cover Grommet | 17402.05 |
| 1976-1979 CJ5 (3.8L), 1976-1980 CJ5 (4.2L), 1976-1979 CJ7 (3.8L), 1976-1980 CJ7 (4.2L), Valve Cover Grommet | 17402.03 |
| 1981-1983 CJ5 (4.2L), 1981-1986 CJ7 (4.2L), 1981-1986 CJ8 (4.2L), 1987-1990 Wrangler (4.2L), Valve Cover Grommet | 17402.02 |
| 1982-1983 CJ5 [2.5L GM & 2.5L AMC], 1982-1986 CJ7 [2.5L GM & 2.5L AMC], 1982-1986 CJ8 [2.5L GM & 2.5L AMC], Valve Cover Grommet | 17402.02 |

D. Oil Caps

| | Part# |
|--|----------|
| 1972-1979 CJ5 (3.8L), 1972-1980 CJ5 (4.2L), 1980-1983 CJ5 (2.5L GM), 1972-1979 CJ7 (3.8L), 1972-1980 CJ7 (4.2L), 1980-1983 CJ7 (2.5L GM), 1981-1983 CJ8 (2.5L GM), 1965-1970 J-Series Truck, 1965-1971 Wagoneer, 1974-1979 Cherokee (SJ), Oil Cap | 17403.01 |
| 1972-1981 CJ5 (5.0L), 1972-1976 CJ6 (5.0L), 1976-1981 CJ7 (5.0L), 1981-1981 CJ8 (5.0L), 1972-1991 Cherokee / Grand Wagoneer (5.0L, 5.9L, 6.6L), Oil Cap | 17403.04 |
| 1981-1983 CJ5 (4.2L), 1983 CJ5 (2.5L AMC), 1981-1986 CJ7 (4.2L), 1983-1986 CJ7 (2.5L AMC), 1981-1986 CJ8 (4.2L), 1983-1986 CJ8 (2.5L AMC), 1987-1993 Wrangler (2.5L), 1987-1990 Wrangler (4.2L), 1986-1993 Cherokee (2.5L), 1987-1990 Cherokee (4.0L), Oil Cap | 17403.02 |
| 1991-2006 Wrangler (4.0L), 1987-2006 Cherokee (4.0L), 1993-2004 Grand Cherokee (4.0L), 1994-1998 Grand Cherokee (5.2L), 1998 Grand Cherokee (5.9L), 1972-1990 Cherokee / Grand Wagoneer (5.0L, 5.9L & 6.6L), Oil Cap | 17403.03 |



[E] 17437.01

[F] 17438.03

[H] 17405.01

E. Oil Pans

| | Part# |
|--|----------|
| 1972-1979 Models (3.8L), 1972-1990 (4.2L), Oil Pan | 17437.01 |
| 1987-2006 Models, Oil Pan [4.0L] | 17437.02 |

F. Oil Pan Drain Plugs

| | Part# |
|---|----------|
| 1941-1971 Models, Oil Pan Drain Plug [134 CI] | 17438.01 |
| 1941-1971 Models, Oil Pan Drain Plug Gasket [134 CI] | 17438.02 |
| 1972-1979 Models (3.8L), 1972-1990 (4.2L), Oil Pan Drain Plug | 17438.03 |
| 1987-2006 Models (4.0L), 2002-2006 (2.4L), Oil Pan Drain Plug | 17438.04 |

G. Intake Manifold

| | Part# |
|---|----------|
| 1941-1945 MB, 1941-1945 GPW, 1945-1949 CJ2A, 1948-1953 CJ3A, 1950-1952 M38, Intake Manifold [134 CI L-Head] | 17738.01 |

H. Engine Overhaul Kits

| | Part# |
|--|----------|
| 1941-1945 MB, 1941-1945 Ford GPW, Engine Overhaul Kit [134 CI L-Head With Chain Driven Camshaft] | 17405.01 |
| 1945-1949 CJ2A, 1948-1953 CJ3A, 1950-1952 M38, Engine Overhaul Kit [134 CI L-Head With Gear Driven Camshaft] | 17405.02 |
| 1952-1971 M38A1, 1953-1967 CJ3B, 1955-1971 CJ5, 1955-1971 CJ6, Engine Overhaul Kit [134 CI With F-Head] | 17405.03 |



[I] 17440.04

[J] 17442.04

[K] 17441.01

| I. Engine Gasket Sets | Part# |
|---|----------|
| 1941-1945 MB, 1941-1945 GPW, 1945-1949 CJ2A, 1948-1953 CJ3A, 1950-1952 M38, Engine Gasket Set [134 CI L-Head] | 17440.01 |
| 1952-1971 M38A1, 1953-1967 CJ3B, 1955-1971 CJ5, 1955-1971 CJ6, Engine Gasket Set [134 CI With F-Head] | 17440.02 |
| 1954-1964 Models, Engine gasket Set [226 CI] NEW | 17440.03 |
| 1972-1980 Models, Engine Gasket Set [3.8L & 4.2L] | 17440.04 |
| 1972-1981 Models, Engine Gasket Set [5.0L] | 17440.07 |
| 1972-1991 Models, Engine Gasket Set [5.9L & 6.6L] | 17440.08 |
| 1981-1990 Models, Engine Gasket Set [4.2L] | 17440.05 |
| 1987-1990 Models, Engine Gasket Set [4.0L] | 17440.06 |

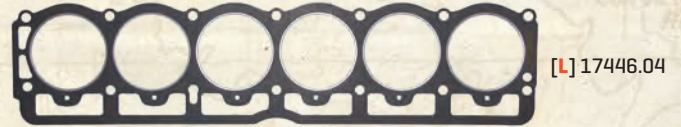

[L] 17446.04



[M] 17447.01



OMIX-ADA, Inc.

| J. Lower Gasket Sets | Part# |
|---|----------|
| 1966-1971 Models, Lower Gasket Set [225 CI] | 17442.08 |
| 1972-1990 Models [3.8L & 4.2L], 1987-1991 Models [4.0L], Lower Gasket Set | 17442.04 |
| 1972-1981 Models [5.0L], 1972-1991 Models [5.9L & 6.6L], Lower Gasket Set | 17442.07 |
| 1980-1983 Models, Lower Gasket Set [2.5L GM] | 17442.01 |
| 1983-1992 Models, Lower Gasket Set [2.5L AMC] | 17442.02 |
| 1992-2002 Models, Lower Gasket Set [2.5L] | 17442.03 |
| 1992-2000 Models, Lower Gasket Set [4.0L] | 17442.06 |
| 2002-2009 Models, Lower Gasket Set [3.7L] NEW | 17442.09 |
| 2004-2009 Models, Lower Gasket Set [4.7L] NEW | 17442.10 |

| M. Valve Cover Gaskets | Part# |
|---|----------|
| 1941-1971 Models, Lifter Cover Gasket [134 CI] NEW | 17450.07 |
| 1952-1971 M38A1, 1953-1967 CJ3B, 1955-1971 CJ5, 1955-1971 CJ6, Valve Cover Gasket [134 F-Head] | 17447.01 |
| 1972-1979 CJ5 [3.8L], 1972-1980 CJ5 [4.2L], 1972-1979 CJ7 [3.8L], 1972-1980 CJ7 [4.2L], 1965-1970 J-Series Truck, 1965-1971 Wagoneer, 1974-1979 Cherokee [SJ], Valve Cover Gasket | 17447.02 |
| 1972-1981 CJ5 [5.0L], 1972-1976 CJ6 [5.0L], 1976-1981 CJ7 [5.0L], 1981 CJ8 [5.0L], 1972-1991 Cherokee / Grand Wagoneer [5.0L, 5.9L, 6.6L], Valve Cover Gaskets [Pair] | 17447.06 |
| 1981-1983 CJ5, 1981-1986 CJ7, 1981-1986 CJ8, 1987 Wrangler, 1981-1987 Cherokee / Grand Cherokee [SJ], Aluminum Valve Cover Gasket Kit [4.2L], Includes Gasket [Rubber], Grommets, Oil Cap & Valve Cover Bolts | 17447.05 |
| 1981-1983 CJ5 [4.2L], 1981-1986 CJ7 [4.2L], 1981-1986 CJ8 [4.2L], 1987-1990 Wrangler [4.2L], Valve Cover Gasket, Cork | 17447.03 |
| 1981-1983 CJ5 [4.2L], 1981-1986 CJ7 [4.2L], 1981-1986 CJ8 [4.2L], 1987-1990 Wrangler [4.2L], Valve Cover Gasket, Rubber | 17447.04 |
| 1983-2002 Models, Valve Cover Gasket [2.5L AMC], Rubber NEW | 17477.14 |
| 1993-1998 Grand Cherokee [5.2L], 1998 Grand Cherokee [5.9L], Valve Cover Gaskets, Pair | 17447.08 |
| 1997-2006 Wrangler [4.0L], 1996-2001 Cherokee [4.0L], 1996-2004 Grand Cherokee [4.0L], Valve Cover Gasket | 17447.09 |
| 1999-2003 Grand Cherokee [4.7L], Valve Cover Gasket, Left | 17447.10 |
| 1999-2003 Grand Cherokee [4.7L], Valve Cover Gasket, Right | 17447.12 |
| 2002-2005 Liberty [3.7L], Valve Cover Gasket, Left NEW | 17447.11 |
| 2002-2005 Liberty [3.7L], Valve Cover Gasket, Right NEW | 17447.13 |
| 2003-2006 Wrangler [2.4L], 2002-2005 Liberty [2.4L], Valve Cover gasket | 17447.07 |

| K. Upper Gasket Sets | Part# |
|--|----------|
| 1941-1953 Models, Upper Gasket Set [134 CI With L-Head] | 17441.01 |
| 1952-1971 Models, Upper Gasket Set [134 CI With F-Head] | 17441.02 |
| 1966-1971 Models, Upper Gasket Set [225 CI] | 17441.12 |
| 1972-1980 Models, Upper Gasket Set [3.8L & 4.2L] | 17441.06 |
| 1972-1981 Models, Upper Gasket Set [5.0L] | 17441.10 |
| 1972-1991 Models, Upper Gasket Set [5.9L & 6.6L] | 17441.11 |
| 1980-1983 Models, Upper Gasket Set [2.5L GM] | 17441.03 |
| 1981-1990 Models, Upper Gasket Set [4.2L] | 17441.07 |
| 1983-1986 Models, Upper Gasket Set [2.5L AMC] | 17441.04 |
| 1987-1993 Models, Upper Gasket Set [2.5L] | 17441.05 |
| 1987-1990 Models, Upper Gasket Set [4.0L] | 17441.08 |
| 1991-1998 Models, 1999 Wrangler, Upper Gasket Set [4.0L] | 17441.09 |

| L. Cylinder Head Gaskets | Part# |
|--|----------|
| 1941-1953 Models, Cylinder Head Gasket [134 CI With L-Head] | 17446.01 |
| 1952-1971 Models, Cylinder Head Gasket [134 CI With F-Head] | 17446.02 |
| 1954-1964 Models, Cylinder Head Gasket [226 CI] NEW | 17446.09 |
| 1966-1971 Models, Cylinder Head Gasket Set [225 CI] | 17446.10 |
| 1972-1980 Models, Cylinder Head Gasket [3.8L & 4.2L] | 17446.04 |
| 1972-1981 Models, Head Gasket [5.0L] | 17446.06 |
| 1972-1981 Models, Head Gasket [5.0L], High Temp UPGRADE | 17446.08 |
| 1972-1991 Models, Head Gasket [5.9L & 6.6L] | 17446.07 |
| 1983-2002 Models, Cylinder Head Gasket [2.5L AMC] | 17446.03 |
| 1987-1996 Models, Cylinder Head Gasket [4.0L] | 17446.05 |
| 1997-2006 Models, Cylinder Head Gasket [4.0L] | 17466.09 |
| 1999-2007 Models, Head Gasket [4.7L], LH or RH NEW | 17466.10 |
| 2002-2009 Models, Cylinder Head Gasket [3.7L], LH or RH NEW | 17466.11 |

| N. Oil Pan Gaskets | Part# |
|--|----------|
| 1941-1971 Models, Oil Pan Gasket [134 CI] | 17439.01 |
| 1966-1971 Models, Oil Pan Gasket [225 CI] | 17439.08 |
| 1972-1979 Models [3.8L], 1972-1990 [4.2L], Oil Pan Gasket, Cork | 17439.05 |
| 1972-1979 Models [3.8L], 1972-1990 [4.2L], Oil Pan Gasket, Rubber NEW | 17439.06 |
| 1972-1981 Models [5.0L], 1972-1991 [5.9L], 1974-1979 [6.6L], Oil Pan Gasket | 17439.07 |
| 1983-1990 Models, Oil Pan Gasket [2.5L AMC], Cork | 17439.02 |
| 1987-2006 Models, Oil Pan Gasket [4.0L], Rubber | 17439.06 |
| 1991-1996 Models, Oil Pan Gasket [2.5L], Cork | 17439.03 |
| 1997-2002 Models, Oil Pan Gasket [2.5L], Rubber | 17439.04 |
| 1999-2009 Models, Oil Pan Gasket [4.7L] NEW | 17439.09 |
| 2002-2011 Models, Oil Pan Gasket [3.7L] NEW | 17439.10 |

| O. Timing Cover Gaskets | Part# |
|--|----------|
| 1972-1990 [3.8L & 4.2L], 1983-1993 Models [2.5L], 1987-1992 [4.0L], Timing Cover Gasket | 17449.01 |
| 1972-1991 Jeep Models, AMC Models: 1966 Classic, 1967-1974 Ambassador, 1967-1968 American, 1967-1970 Rebel, 1968-1979 AMX, 1968-1974 Javelin, 1969 Rambler, 1970-1977 Hornet, 1971-1978 Matador, 1972-1976 Gremlin, 1978-1979 Concord, 1978-1979 Pacer, Timing Cover Gasket [5.0L, 5.9L & 6.6L] NEW | 17449.03 |
| 1972-1991 Jeep Models, AMC Models: 1966 Classic, 1967-1974 Ambassador, 1967-1968 American, 1967-1970 Rebel, 1968-1979 AMX, 1968-1974 Javelin, 1969 Rambler, 1970-1977 Hornet, 1971-1978 Matador, 1972-1976 Gremlin, 1978-1979 Concord, 1978-1979 Pacer, Timing Cover Gasket Kit [5.0L, 5.9L & 6.6L] NEW | 17449.02 |

All images are subject to be representative. More detailed information is available online.



| P. Intake & Exhaust Manifold Gaskets | Part# |
|---|----------|
| 1966-1971 Models, Intake Gasket Set [225 CI] | 17445.01 |
| 1972-1981 Models [5.0L], 1972-1991 Models [5.9L & 6.6L], Intake Manifold Gasket | 17451.07 |
| 1999-2006 Models, Intake Gasket Set [4.7L] | 17445.03 |
| 2002-2007 Models, Intake Gasket [3.7L] NEW | 17445.04 |



[P] 17445.01

| Q. Camshaft Seal | Part# |
|--|----------|
| 2002-2006 Models, Camshaft Seal [2.4L] | 17466.63 |



[R] 17458.01

| R. Crankshaft Oil Seals | Part# |
|--|----------|
| 1941-1971 Models, Rear Main Bearing Cap Side Oil Seal [134 CI] NEW | 17458.06 |
| 1941-1971 Models, Crankshaft Oil Seal [134 CI], 4 Piece Kit | 17458.01 |
| 1972-1990 Models [3.8L & 4.2L], 1987-2006 Models [4.0L], Crankshaft Oil Seal NEW | 17459.01 |
| 1972-1990 Models [3.8L & 4.2L], 1987-2006 Models [4.0L], Crankshaft Oil Seal, Pair NEW | 17458.03 |
| 1972-1981 Models [5.0L], 1972-1991 Models [5.9L & 6.6L], Crank Shaft Seal, Front [Timing Cover] NEW | 17449.50 |
| 1972-1981 Models [5.0L], 1972-1991 Models [5.9L & 6.6L], Crank Shaft Seal, Rear | 17458.04 |
| 1980-1983 Models, Crankshaft Oil Seal [2.5L GM] | 17458.07 |
| 1983-2002 Models, Crankshaft Oil Seal [2.5L AMC] | 17458.02 |
| 2002-2006 Models, Crankshaft Oil Seal [2.4L] | 17466.63 |



[S] 17427.01

[T] 17430.01



| S. Pistons | Part# |
|---|----------|
| 1941-1971 Models, Piston [134 CI], Std, each | 17427.01 |
| 1941-1971 Models, Piston [134 CI], .020" Over | 17427.02 |
| 1941-1971 Models, Piston [134 CI], .030" Over | 17427.03 |
| 1941-1971 Models, Piston [134 CI], .040" Over | 17427.04 |
| 1941-1971 Models, Piston [134 CI], .060" Over | 17427.05 |
| 1941-1971 Models, Piston [134 CI], .080" Over | 17427.06 |
| 1954-1964 Models, Piston [226 CI], Std | 17427.13 |
| 1954-1964 Models, Piston [226 CI], .020" Over NEW | 17427.14 |
| 1954-1964 Models, Piston [226 CI], .030" Over | 17427.15 |
| 1954-1964 Models, Piston [226 CI], .040" Over | 17427.16 |
| 1954-1964 Models, Piston [226 CI], .060" Over | 17427.17 |
| 1954-1964 Models, Piston Pin Bushing Set [226 CI], 6 Pieces | 17428.01 |
| 1966-1971 Models, Piston [225 CI], Std | 17427.30 |
| 1966-1971 Models, Piston [225 CI], .020" Over | 17427.31 |
| 1966-1971 Models, Piston [225 CI], .030" Over | 17427.32 |
| 1966-1971 Models, Piston [225 CI], .040" Over | 17427.33 |
| 1972-1978 Models, Piston [3.8L or 4.2L], Std | 17427.18 |
| 1972-1978 Models, Piston [3.8L or 4.2L], .020" Over | 17427.19 |
| 1972-1978 Models, Piston [3.8L or 4.2L], .030" Over | 17427.20 |
| 1972-1981 Models, Piston [5.0L], Std | 17427.23 |
| 1972-1981 Models, Piston [5.0L], .030" Over | 17427.24 |
| 1972-1991 Models, Piston [5.9L], Std | 17427.25 |
| 1972-1991 Models, Piston [5.9L], .030" Over | 17427.26 |
| 1974-1979 Models, Piston [6.6L], Std | 17427.27 |
| 1974-1979 Models, Piston [6.6L], .030" Over | 17427.28 |
| 1979-1990 Models, Piston [4.2L], Std | 17427.21 |
| 1979-1990 Models, Piston [4.2L], .020" Over | 17427.22 |
| 1979-1990 Models, Piston [4.2L], .030" Over | 17427.29 |
| 1983-1995 Models, Piston [2.5L AMC], Std | 17427.07 |
| 1983-1995 Models, Piston [2.5L AMC], .010" Over | 17427.11 |
| 1983-1995 Models, Piston [2.5L AMC], .020" Over | 17427.08 |
| 1983-1995 Models, Piston [2.5L AMC], .030" Over | 17427.09 |
| 1983-1995 Models, Piston [2.5L AMC], .040" Over | 17427.10 |
| 1987-1993 Models, Piston [4.0L], Std | 17427.07 |
| 1987-1993 Models, Piston [4.0L], .010" Over | 17427.11 |
| 1987-1993 Models, Piston [4.0L], .020" Over | 17427.08 |
| 1987-1993 Models, Piston [4.0L], .030" Over | 17427.09 |
| 1987-1993 Models, Piston [4.0L], .040" Over | 17427.10 |
| 1996-2006 Models, Piston [2.5L], Std | 17427.12 |
| 1996-2000 Models, Piston [4.0L], Std | 17427.12 |
| 1999-2007 Models [4.7L] 2003-2011 [3.7L], Piston, Std NEW | 17427.38 |
| 1999-2007 Models [4.7L] 2003-2011 [3.7L], Piston, 10mm Over NEW | 17427.39 |
| 1999-2007 Models [4.7L] 2003-2011 [3.7L], Piston, 25mm Over NEW | 17427.40 |
| 1999-2007 Models [4.7L] 2003-2011 [3.7L], Piston, 50mm Over NEW | 17427.41 |
| 1999-2007 Models [4.7L] 2003-2011 [3.7L], Piston, 75mm Over NEW | 17427.42 |
| 1999-2007 Models [4.7L] 2003-2011 [3.7L], Piston, 100mm Over NEW | 17427.43 |

| T. Piston Ring Sets | Part# |
|---|----------|
| 1941-1971 Models, Piston Ring Sets [134 CI], Std | 17430.01 |
| 1941-1971 Models, Piston Ring Sets [134 CI], .020" Over | 17430.02 |
| 1941-1971 Models, Piston Ring Sets [134 CI], .030" Over | 17430.03 |
| 1941-1971 Models, Piston Ring Sets [134 CI], .040" Over | 17430.04 |
| 1941-1971 Models, Piston Ring Sets [134 CI], .060" Over | 17430.05 |
| 1941-1971 Models, Piston Ring Sets [134 CI], .080" Over | 17430.06 |
| 1954-1964 Models, Piston Ring Set [226 CI], Std | 17430.13 |
| 1954-1964 Models, Piston Ring Set [226 CI], .010" Over | 17430.14 |
| 1954-1964 Models, Piston Ring Set [226 CI], .020" Over | 17430.15 |
| 1954-1964 Models, Piston Ring Set [226 CI], .030" Over | 17430.16 |
| 1954-1964 Models, Piston Ring Set [226 CI], .040" Over | 17430.17 |
| 1954-1964 Models, Piston Ring Set [226 CI], .060" Over | 17430.18 |
| 1966-1971 Models, Piston Ring Set [225 CI], Std | 17430.50 |
| 1966-1971 Models, Piston Ring Set [225 CI], .020" Over | 17430.51 |
| 1966-1971 Models, Piston Ring Set [225 CI], .030" Over | 17430.52 |
| 1966-1971 Models, Piston Ring Set [225 CI], .040" Over | 17430.53 |
| 1966-1971 Models, Piston Ring Set [225 CI], .060" Over | 17430.54 |
| 1972-1990 Models, Piston Ring Set [3.8L or 4.2L], Std | 17430.19 |
| 1972-1990 Models, Piston Ring Set [3.8L or 4.2L], .020" Over | 17430.20 |
| 1972-1990 Models, Piston Ring Set [3.8L or 4.2L], .030" Over | 17430.21 |
| 1972-1990 Models, Piston Ring Set [3.8L or 4.2L], .040" Over | 17430.22 |
| 1972-1990 Models, Piston Ring Set [3.8L or 4.2L], .060" Over | 17430.23 |
| 1972-1981 Models, Piston Ring Set [5.0L], Std | 17430.28 |
| 1972-1981 Models, Piston Ring Set [5.0L], .020" Over | 17430.29 |
| 1972-1981 Models, Piston Ring Set [5.0L], .030" Over | 17430.30 |
| 1972-1991 Models, Piston Ring Set [5.9L], Std | 17430.31 |
| 1972-1991 Models, Piston Ring Set [5.9L], .010" Over | 17430.32 |
| 1972-1991 Models, Piston Ring Set [5.9L], .020" Over | 17430.33 |
| 1972-1991 Models, Piston Ring Set [5.9L], .030" Over | 17430.34 |
| 1974-1979 Models, Piston Sing Set [6.6L], Std | 17430.35 |
| 1974-1979 Models, Piston Sing Set [6.6L], .020" Over | 17430.36 |
| 1974-1979 Models, Piston Sing Set [6.6L], .030" Over | 17430.37 |
| 1983-1995 Models, Piston Ring Set [2.5L AMC], Std | 17430.09 |
| 1983-1995 Models, Piston Ring Set [2.5L AMC], .010" Over | 17430.10 |
| 1983-1995 Models, Piston Ring Set [2.5L AMC], .020" Over | 17430.11 |
| 1983-1995 Models, Piston Ring Set [2.5L AMC], .030" Over | 17430.12 |
| 1987-1993 Models, Piston Ring Set [4.0L], Std | 17430.24 |
| 1987-1993 Models, Piston Ring Set [4.0L], .010" Over | 17430.25 |
| 1987-1993 Models, Piston Ring Set [4.0L], .020" Over | 17430.26 |
| 1987-1993 Models, Piston Ring Set [4.0L], .030" Over | 17430.27 |
| 1993-1998 Models, Piston Ring Set [5.2L], Std | 17430.38 |
| 1993-1998 Models, Piston Ring Set [5.2L], .020" Over | 17430.39 |
| 1993-1998 Models, Piston Ring Set [5.2L], .030" Over | 17430.40 |
| 1999-2007 Models, Piston Ring Set [4.7L], Std NEW | 17430.45 |
| 1999-2007 Models, Piston Ring Set [4.7L], 25mm Over NEW | 17430.46 |
| 1999-2007 Models, Piston Ring Set [4.7L], 50mm Over NEW | 17430.47 |
| 1999-2007 Models, Piston Ring Set [4.7L], 75mm Over NEW | 17430.48 |
| 1999-2007 Models, Piston Ring Set [4.7L], 100mm Over NEW | 17430.49 |

[U] 16910.01



[U] 16910.03



[V] 17465.04



[V] 17465.03



OMIX-ADA, Inc.

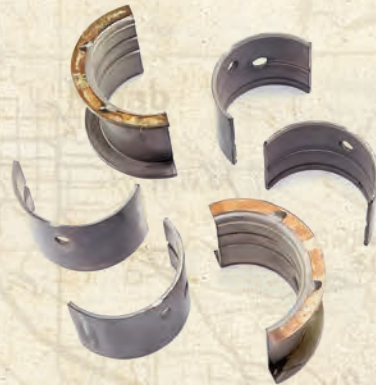

[V] 17465.06



[V] 17465.32

U. Crankshaft Pilot Bearings

| | Part# |
|--|----------|
| 1941-1971 Models, Crankshaft Pilot Bearing [134 CI] | 16910.01 |
| 1972-1975 Models, Crankshaft Pilot Bearing [3.8L, 4.2L, 5.0L & 5.9L] | 16910.04 |
| 1977-1979 Models, Crankshaft Pilot Bearing [3.8L, 4.2L, 5.0L & 5.9L] | 16910.05 |
| 1980-1983 Models, Crankshaft Pilot Bearing [2.5L GM] | 16910.02 |
| 1980-1986 Models, Crankshaft Pilot Bearing [4.2L, 5.0L & 5.9L] | 16910.06 |
| 1983-2000 Models, Crankshaft Pilot Bearing [2.5L AMC With MT] | 16910.03 |
| 1987-1991 Models, Crankshaft Pilot Bearing [4.0L & 4.2L] | 16910.07 |
| 1992-1999 Models, Crankshaft Pilot Bearing [4.0L] | 16910.08 |
| 2003-2006 Models, Crankshaft Pilot Bearing [2.4L] | 16910.10 |

V. Main Bearings

Part#

| | |
|---|----------|
| 1941-1971 Models, Main Bearing Set [134 CI], Std Bore | 17465.01 |
| 1941-1971 Models, Main Bearing Set [134 CI], .010" Over | 17465.02 |
| 1941-1971 Models, Main Bearing Set [134 CI], .020" Over | 17465.03 |
| 1941-1971 Models, Main Bearing Set [134 CI], .030" Over | 17465.04 |
| 1941-1971 Models, Main Bearing Set [134 CI], .040" Over | 17465.05 |
| 1941-1971 Models, Main Bearing Set [134 CI], .050" Over | 17465.06 |
| 1941-1971 Models, Main Bearing Set [134 CI], .060" Over | 17465.07 |
| 1941-1971 Models, Main Bearing Set [134 CI], .070" Over | 17465.08 |
| 1941-1971 Models, Main Bearing Set [134 CI], .080" Over | 17465.09 |
| 1954-1964 Models, Main Bearing Set [226 CI], Std Bore | 17465.27 |
| 1954-1964 Models, Main Bearing Set [226 CI], .010" Over | 17465.28 |
| 1954-1964 Models, Main Bearing Set [226 CI], .020" Over | 17465.29 |
| 1954-1964 Models, Main Bearing Set [226 CI], .030" Over | 17465.30 |
| 1954-1964 Models, Main Bearing Set [226 CI], .040" Over | 17465.31 |
| 1954-1964 Models, Main Bearing Set [226 CI], .060" Over | 17465.32 |
| 1972-1990 Models, Main Bearing Set [3.8L, 4.0L & 4.2L], Std Bore | 17465.35 |
| 1972-1990 Models, Main Bearing Set [3.8L, 4.0L & 4.2L], .010" Over | 17465.36 |
| 1972-1990 Models, Main Bearing Set [3.8L, 4.0L & 4.2L], .020" Over | 17465.37 |
| 1972-1990 Models, Main Bearing Set [3.8L, 4.0L & 4.2L], .030" Over | 17465.38 |
| 1972-1981 Models [5.0L], 1972-1991 [5.9L], Main Bearing Set, Std Bore | 17465.49 |
| 1972-1981 Models [5.0L], 1972-1991 [5.9L], Main Bearing Set, .010" Over | 17465.50 |
| 1972-1981 Models [5.0L], 1972-1991 [5.9L], Main Bearing Set, .020" Over | 17465.51 |
| 1972-1981 Models [5.0L], 1972-1991 [5.9L], Main Bearing Set, .030" Over | 17465.52 |
| 1974-1979 Models [6.6L], Main Bearing Set, Std Bore | 17465.56 |
| 1974-1979 Models [6.6L], Main Bearing Set, .010" Over | 17465.57 |
| 1974-1979 Models [6.6L], Main Bearing Set, .030" Over | 17465.59 |
| 1974-1979 Models [6.6L], Main Bearing Set, .020" Over | 17465.58 |
| 1983-1990 Models, Main Bearing Set [2.5L AMC], Std Bore | 17465.12 |
| 1983-1990 Models, Main Bearing Set [2.5L AMC], .010" Over | 17465.13 |
| 1983-1990 Models, Main Bearing Set [2.5L AMC], .020" Over | 17465.14 |
| 1983-1990 Models, Main Bearing Set [2.5L AMC], .030" Over | 17465.15 |
| 1991-2002 Models [2.5L], 1997-2006 [4.0L], Main Bearing Set, Std Bore | 17465.18 |
| 1991-2002 Models [2.5L], 1997-2006 [4.0L], Main Bearing Set, .010" Over | 17465.19 |
| 1991-2002 Models [2.5L], 1997-2006 [4.0L], Main Bearing Set, .020" Over | 17465.20 |
| 1991-2002 Models [2.5L], 1997-2006 [4.0L], Main Bearing Set, .030" Over | 17465.21 |
| 1991-2002 Models [2.5L], 1997-2006 [4.0L], Main Bearing Set, .040" Over | 17465.22 |
| 1991-1996 Models, Main Bearing Set [4.0L], Std Bore | 17465.42 |
| 1991-1996 Models, Main Bearing Set [4.0L], .010" Over | 17465.43 |
| 1991-1996 Models, Main Bearing Set [4.0L], .020" Over | 17465.44 |
| 1991-1996 Models, Main Bearing Set [4.0L], .030" over | 17465.45 |
| 1993-1998 Models, Main Bearing Set [5.2L], Std Bore | 17465.80 |
| 1993-1998 Models, Main Bearing Set [5.2L], .010" Over | 17465.81 |
| 1993-1998 Models, Main Bearing Set [5.2L], .020" Over | 17465.82 |
| 1993-1998 Models, Main Bearing Set [5.2L], .030" Over | 17465.83 |
| 1993-1998 Models, Main Bearing Set [5.2L], .040" Over | 17465.84 |
| 1998 Models, Main Bearing Set [5.9L], Std Bore | 17465.90 |
| 1998 Models, Main Bearing Set [5.9L], .010" Over | 17465.91 |
| 1998 Models, Main Bearing Set [5.9L], .020" Over | 17465.92 |
| 1998 Models, Main Bearing Set [5.9L], .030" Over | 17465.93 |
| 1998 Models, Main Bearing Set [5.9L], .040" Over | 17465.94 |
| 1999-2006 Models, Main Bearing Set [4.7L], Std Bore | 17465.70 |
| 1999-2006 Models, Main Bearing Set [4.7L], .010" Over | 17465.71 |
| 1999-2006 Models, Main Bearing Set [4.7L], .020" Over | 17465.72 |
| 1999-2006 Models, Main Bearing Set [4.7L], .030" Over NEW | 17465.73 |
| 1999-2006 Models, Main Bearing Set [4.7L], .040" Over NEW | 17465.74 |
| 2002-2006 Models, Main Bearing Set [2.4L], Std Bore | 17465.65 |
| 2002-2006 Models, Main Bearing Set [2.4L], .010" Over | 17465.66 |
| 2002-2006 Models, Main Bearing Set [2.4L], .020" Over | 17465.67 |
| 2002-2006 Models, Main Bearing Set [2.4L], .030" Over | 17465.68 |
| 2002-2006 Models, Main Bearing Set [2.4L], .040" Over | 17465.69 |
| 2002-2005 Models, Main Bearing Set [3.7L], Std Bore | 17465.75 |
| 2002-2005 Models, Main Bearing Set [3.7L], .010" Over | 17465.76 |
| 2002-2005 Models, Main Bearing Set [3.7L], .020" Over | 17465.77 |
| 2002-2005 Models, Main Bearing Set [3.7L], .030" Over | 17465.78 |
| 2002-2005 Models, Main Bearing Set [3.7L], .040" Over | 17465.79 |

All images are subject to be representative. More detailed information is available online.



OMIX-ADA, Inc.



[W1] 17467.01



[W1] 17467.13



[Y] 17421.10



[Y] 17420.02

W1. Connecting Rod Bearings (Each)

Part#

| | |
|--|----------|
| 1941-1971 Models, Connecting Rod Bearing (134 CI), Std Bore | 17467.01 |
| 1941-1971 Models, Connecting Rod Bearing (134 CI), .010" Over | 17467.02 |
| 1941-1971 Models, Connecting Rod Bearing (134 CI), .020" Over | 17467.03 |
| 1941-1971 Models, Connecting Rod Bearing (134 CI), .030" Over | 17467.04 |
| 1941-1971 Models, Connecting Rod Bearing (134 CI), .040" Over | 17467.05 |
| 1941-1971 Models, Connecting Rod Bearing (134 CI), .050" Over | 17467.06 |
| 1941-1971 Models, Connecting Rod Bearing (134 CI), .060" Over | 17467.07 |
| 1941-1971 Models, Connecting Rod Bearing (134 CI), .070" Over | 17467.08 |
| 1941-1971 Models, Connecting Rod Bearing (134 CI), .080" Over | 17467.09 |
| 1954-1964 Models, Connecting Rod Bearing (226 CI Odd Cylinders), Std Bore | 17467.12 |
| 1954-1964 Models, Connecting Rod Bearing (226 CI Odd Cylinders), .010 Over | 17467.13 |
| 1954-1964 Models, Connecting Rod Bearing (226 CI Odd Cylinders), .020" Over | 17467.14 |
| 1954-1964 Models, Connecting Rod Bearing (226 CI Odd Cylinders), .030" Over | 17467.15 |
| 1954-1964 Models, Connecting Rod Bearing (226 CI Odd Cylinders), .040" Over | 17467.16 |
| 1954-1964 Models, Connecting Rod Bearing (226 CI Even Cylinders), Std Bore | 17467.18 |
| 1954-1964 Models, Connecting Rod Bearing (226 CI Even Cylinders), .010 Over | 17467.19 |
| 1954-1964 Models, Connecting Rod Bearing (226 CI Even Cylinders), .020" Over | 17467.20 |
| 1954-1964 Models, Connecting Rod Bearing (226 CI Even Cylinders), .030" Over | 17467.21 |
| 1954-1964 Models, Connecting Rod Bearing (226 CI Even Cylinders), .040" Over | 17467.22 |
| 1972-1990 Models (3.8L, 4.0L & 4.2L), 1972-1981 (5.0L), 1974-1979 (6.6L), 1983-2002 (2.5L AMC), 1987-1999 (4.0L), Connecting Rod Bearing, Std Bore | 17467.24 |
| 1972-1990 Models (3.8L, 4.0L & 4.2L), 1972-1981 (5.0L), 1974-1979 (6.6L), 1983-2002 (2.5L AMC), 1987-1999 (4.0L), Connecting Rod Bearing, .001" Over | 17467.25 |
| 1972-1990 Models (3.8L, 4.0L & 4.2L), 1972-1981 (5.0L), 1974-1979 (6.6L), 1983-2002 (2.5L AMC), 1987-1999 (4.0L), Connecting Rod Bearing, .010" Over | 17467.26 |
| 1972-1990 Models (3.8L, 4.0L & 4.2L), 1972-1981 (5.0L), 1974-1979 (6.6L), 1983-2002 (2.5L AMC), 1987-1999 (4.0L), Connecting Rod Bearing, .020" Over | 17467.27 |
| 1972-1990 Models (3.8L, 4.0L & 4.2L), 1972-1981 (5.0L), 1974-1979 (6.6L), 1983-2002 (2.5L AMC), 1987-1999 (4.0L), Connecting Rod Bearing, .030" Over | 17467.28 |
| 1974-1979 Models, Connecting Rod Bearing (6.6L), Std Bore | 17467.32 |
| 1974-1979 Models, Connecting Rod Bearing (6.6L), .010" Over | 17467.33 |
| 1974-1979 Models, Connecting Rod Bearing (6.6L), .020" Over | 17467.34 |
| 1974-1979 Models, Connecting Rod Bearing (6.6L), .030" Over | 17467.35 |
| 1993-1998 Models, Connecting Rod Bearing (5.2L), Std Bore | 17467.39 |
| 1993-1998 Models, Connecting Rod Bearing (5.2L), .001" Over | 17467.40 |
| 1993-1998 Models, Connecting Rod Bearing (5.2L), .002" Over | 17467.41 |
| 1993-1998 Models, Connecting Rod Bearing (5.2L), .010" Over | 17467.42 |

W2. Connecting Rod Bearings (Set)

Part#

| | |
|--|----------|
| 1941-1971 Models, Connecting Rod Bearing Set (134 CI), Std Bore | 17467.60 |
| 1941-1971 Models, Connecting Rod Bearing Set (134 CI), .010" Over | 17467.61 |
| 1941-1971 Models, Connecting Rod Bearing Set (134 CI), .020" Over | 17467.62 |
| 1941-1971 Models, Connecting Rod Bearing Set (134 CI), .030" Over | 17467.63 |
| 1941-1971 Models, Connecting Rod Bearing Set (134 CI), .040" Over | 17467.64 |
| 1941-1971 Models, Connecting Rod Bearing Set (134 CI), .050" Over | 17467.65 |
| 1941-1971 Models, Connecting Rod Bearing Set (134 CI), .060" Over | 17467.66 |
| 1941-1971 Models, Connecting Rod Bearing Set (134 CI), .070" Over | 17467.67 |
| 1941-1971 Models, Connecting Rod Bearing Set (134 CI), .080" Over | 17467.68 |
| 1993-1998 Models, Connecting Rod Bearing Set (5.2L), Std Bore | 17467.80 |
| 1993-1998 Models, Connecting Rod Bearing Set (5.2L), .001" Over | 17467.81 |
| 1993-1998 Models, Connecting Rod Bearing Set (5.2L), .010" Over | 17467.82 |
| 1993-1998 Models, Connecting Rod Bearing (5.2L), .020" Over | 17467.83 |
| 1993-1998 Models, Connecting Rod Bearing (5.2L), .030" Over | 17467.84 |
| 1993-1998 Models, Connecting Rod Bearing (5.2L), .040" Over | 17467.85 |
| 1999-2006 Models, Connecting Rod Bearing Set (4.7L), Std Bore | 17467.50 |
| 1999-2006 Models, Connecting Rod Bearing Set (4.7L), .010" Over | 17467.51 |
| 1999-2006 Models, Connecting Rod Bearing Set (4.7L), .020" Over | 17467.52 |
| 1999-2006 Models, Connecting Rod Bearing Set (4.7L), .030" Over | 17467.53 |
| 1999-2006 Models, Connecting Rod Bearing Set (4.7L), .040" Over | 17467.54 |
| 2002-2006 Models, Connecting Rod Bearing Set (2.4L), Std Bore | 17467.55 |
| 2002-2006 Models, Connecting Rod Bearing Set (2.4L), .010" Over | 17467.56 |
| 2002-2006 Models, Connecting Rod Bearing Set (2.4L), .020" Over | 17467.57 |
| 2002-2006 Models, Connecting Rod Bearing Set (2.4L), .030" Over | 17467.58 |
| 2002-2006 Models, Connecting Rod Bearing Set (2.4L), .040" Over | 17467.59 |
| 2002-2006 Models, Connecting Rod Bearing Set (2.4L) .040 NEW | 17467.70 |
| 2002-2006 Models, Connecting Rod Bearing Set (3.7L), Std Bore NEW | 17467.71 |
| 2002-2006 Models, Connecting Rod Bearing Set (3.7L), .010" Over NEW | 17467.72 |
| 2002-2006 Models, Connecting Rod Bearing Set (3.7L), .020" Over | 17467.77 |
| 2002-2006 Models, Connecting Rod Bearing Set (3.7L), .030" Over | 17467.73 |
| 2002-2006 Models, Connecting Rod Bearing Set (3.7L), .040" Over | 17467.74 |

Y. Camshafts

Part#

| | |
|---|----------|
| 1941-1945 MB, 1941-1945 Ford GPW, Camshaft (134 CI L-Head With Chain Driven Camshaft) | 17421.01 |
| 1945-1949 CJ2A, 1948-1953 CJ3A, 1950-1952 M38, Camshaft (134 CI L-Head With Gear Driven Camshaft) | 17421.02 |
| 1945-1971 Models, Camshaft Thrust Plate (134 CI L-Head With Gear Driven Camshaft & F-Head) | 17470.03 |
| 1952-1971 M38A1, 1953-1967 CJ3B, 1955-1971 CJ5, 1955-1971 CJ6, Camshaft (134 CI With F-Head) | 17421.03 |
| 1962-1965 Models, Camshaft (230 CI) | 17421.06 |
| 1966-1971 Models, Camshaft (225 CI) | 17421.12 |
| 1972-1978 Models, Camshaft (3.8L & 4.2L) | 17421.07 |
| 1972-1978 Models, Camshaft Kit (3.8L & 4.2L), Includes Camshaft, Lube and Lifters | 17420.01 |
| 1972-1991 Models, Camshaft (5.0L, 5.9L, 6.6L) | 17421.10 |
| 1972-1991 Models, Camshaft Kit (5.0L, 5.9L & 6.6L), Includes Camshaft, Lube and Lifters | 17420.03 |
| 1979-1990 Models, Camshaft (4.2L) | 17421.08 |
| 1979-1990 Models, Camshaft Kit (4.2L), Includes Camshaft, Lube and Lifters | 17420.02 |
| 1983-1995 Models, Camshaft (2.5L AMC) | 17421.04 |
| 1987-1995 Models, Camshaft (4.0L) | 17421.09 |
| 1996-2002 Models, Camshaft (2.5L) | 17421.14 |

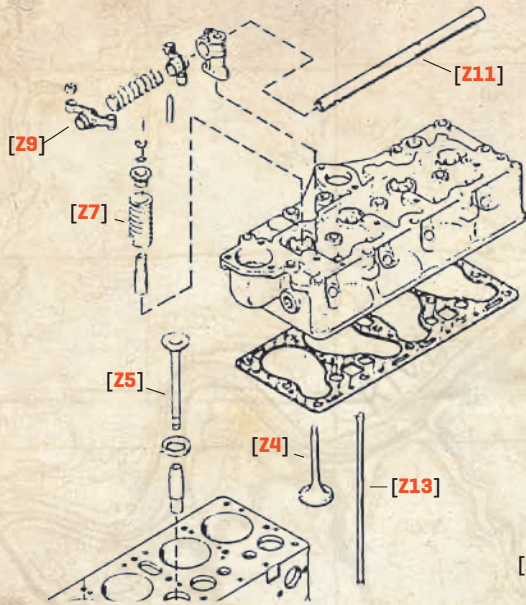

| Z. Camshaft Bearings | Part# |
|---|----------|
| 1941-1971 Models, Camshaft Bearing [134 CI], Std | 17422.01 |
| 1941-1971 Models, Camshaft Bearing [134 CI], .010" Over NEW | 17422.02 |
| 1954-1964 Models, Camshaft Bearing Set [226 CI], Std | 17422.05 |
| 1966-1971 Models, Camshaft Bearing Set [225 CI], Std | 17422.07 |
| 1972-1990 Models, Camshaft Bearing Set [3.8L & 4.2L], Std Bore | 17422.03 |
| 1972-1990 Models, Camshaft Bearing Set [3.8L & 4.2L], .010" Over | 17422.04 |
| 1972-1991 Models, Camshaft Bearing Set [5.0L, 5.9L, 6.6L], Std | 17422.06 |
| 1983-2002 Models [2.5L AMC], 1987-2003 [4.0L], Camshaft Bearing Set, Std | 17422.03 |
| 1983-2002 Models [2.5L AMC], 1987-2003 [4.0L], Camshaft Bearing Set, .010" Over | 17422.04 |
| 1993-1998 Models [5.2L], 1998 [5.9L], Camshaft Bearing Set, Std | 17422.09 |

| Z1. Lifters / Tappets | Part# |
|--|----------|
| 1952-1971 M38A1, 1953-1967 CJ3B, 1955-1971 CJ5, 1955-1971 CJ6, Flat Tappet Lifter | 17418.01 |
| 1972-1979 [3.8L], 1972-1990 [4.2L], 1972-1981 [5.0L], 1983-2002 [2.5L], 1987-1996 [4.0L], Lifter, [8 Required for 4 Cyl, 12 Required for 6 Cyl & 16 Required for V8] | 17418.03 |
| 1993-1998 Models [5.2L], 1998 [5.9L], Lifter, 16 Required | 17418.04 |

| Z2. Connecting Rods | Part# |
|--|----------|
| 1941-1971 Models, Connecting Rod [134 CI Odd Cylinders], 2 Required | 17469.01 |
| 1941-1971 Models, Connecting Rod [134 CI Even Cylinders], 2 Required | 17469.02 |
| 1941-1971 Models, Connecting Rod Bolt With Nut [134 CI] | 17470.12 |
| 1972-1976 Models, Connecting Rod [3.8L & 4.2L] | 17469.03 |
| 1977-1982 Models, Connecting Rod [3.8L & 4.2L] | 17469.04 |
| 1983-1990 Models, Connecting Rod [4.2L] | 17469.05 |

| Z3. Cylinder Head | Part# |
|---|----------|
| 1987-1990 Wrangler [4.2L], Cylinder Head, Assembled [For Use w/ Aluminum Valve Cover] | 17407.01 |

| Z4. Intake Valves | Part# |
|--|----------|
| 1941-1945 MB, 1941-1945 Ford GPW, 1945-1949 CJ2A, 1948-1953 CJ3A, Intake Valve [134 CI L-Head] | 17417.01 |
| 1952-1971 M38A1, 1953-1967 CJ3B, 1955-1971 CJ5, 1955-1971 CJ6, Intake Valve [134 CI F-Head] | 17417.02 |
| 1954-1964 Models, Intake Valve [226 CI] | 17417.13 |
| 1972-1980 Models, Intake Valve [3.8L, 4.2L & 5.0L], Std | 17417.05 |
| 1972-1980 Models, Intake Valve [3.8L, 4.2L & 5.0L], .003" Over | 17417.06 |
| 1972-1980 Models, Intake Valve [3.8L, 4.2L & 5.0L], .015" Over | 17417.07 |
| 1974-1979 Models [6.6L], 1974-1991 [5.9L], Intake Valve | 17417.11 |
| 1981-1990 Models, Intake Valve [4.2L], Std | 17417.08 |
| 1981-1990 Models, Intake Valve [4.2L], .003" Over | 17417.09 |
| 1981-1990 Models, Intake Valve [4.2L], .015" Over | 17417.10 |
| 1987-1998 Models, Intake Valve [2.5L & 4.0L], Std | 17417.03 |
| 1987-1998 Models, Intake Valve [2.5L & 4.0L], .015" Over | 17417.04 |
| 1993-1998 Models, Intake Valve [5.2L] | 17417.12 |
| 2002-2009 Models, Intake Valve [3.7L] NEW | 17417.19 |

| Z5. Exhaust Valves | Part# |
|---|----------|
| 1941-1945 MB, 1941-1945 Ford GPW, 1945-1949 CJ2A, 1948-1953 CJ3A, Intake Spring [134 CI L-Head] | 17415.01 |
| 1952-1971 M38A1, 1953-1967 CJ3B, 1955-1971 CJ5, 1955-1971 CJ6, Exhaust Valve [134 CI F-Head] | 17415.02 |
| 1954-1964 Models, Exhaust Valve [226 CI] | 17415.13 |
| 1966-1971 Models, Exhaust Valve [225 CI], 1.375" Diameter | 17415.14 |
| 1972-1980 Models, Exhaust Valve [3.8L, 4.2L & 5.0L], Std | 17415.05 |
| 1972-1980 Models, Exhaust Valve [3.8L, 4.2L & 5.0L], .003" Over | 17415.06 |
| 1972-1980 Models, Exhaust Valve [3.8L, 4.2L & 5.0L], .015" Over | 17415.07 |
| 1974-1979 Models [6.6L], 1974-1991 [5.9L], Exhaust Valve | 17415.11 |
| 1981-1990 Models, Exhaust Valve [4.2L], Std | 17415.08 |
| 1981-1990 Models, Exhaust Valve [4.2L], .003" Over | 17415.09 |
| 1981-1990 Models, Exhaust Valve [4.2L], .015" Over | 17415.10 |
| 1987-1998 Models, Exhaust Valve [2.5L & 4.0L], Std | 17415.03 |
| 1987-1998 Models, Exhaust Valve [2.5L & 4.0L], .015" Over | 17415.04 |
| 1993-1998 Models, Exhaust Valve [5.2L] | 17415.12 |

| Z6. Valve Stem Seals & Guides | Part# |
|--|----------|
| 1941-1971 Models, Exhaust Valve Guide [134 CI] | 17416.01 |
| 1941-1945 MB, 1941-1945 Ford GPW, 1945-1949 CJ2A, 1948-1953 CJ3A, Intake Valve Guide [134 CI L-Head] | 17416.02 |
| 1952-1971 M38A1, 1953-1967 CJ3B, 1955-1971 CJ5, 1955-1971 CJ6, Intake Valve Guide [134 CI F-Head] | 17416.03 |
| 1952-1971 M38A1, 1953-1967 CJ3B, 1955-1971 CJ5, 1955-1971 CJ6, Intake Valve Stem Seal [134 CI F-Head] NEW | 17443.06 |
| 1972-1991 Models, Valve Stem Seal [3.8L, 4.2L, 5.0L, 5.9L & 6.6L], Intake & Exhaust | 17443.05 |
| 1983-1986 Models, Valve Stem Seal [2.5L AMC], Intake & Exhaust | 17443.01 |
| 1987-1993 Models, Valve Stem Seal [2.5L & 4.0L], Intake | 17443.03 |
| 1987-1993 Models, Valve Stem Seal [2.5L & 4.0L], Exhaust | 17443.02 |
| 1993-1998 Models [5.2L], 1998 [5.9L], 1994-2002 [2.5L], 1994-2006 [4.0L], Exhaust Stem Seal | 17443.04 |

| Z7. Valve Springs | Part# |
|---|----------|
| 1941-1945 MB, 1941-1945 Ford GPW, 1945-1949 CJ2A, 1948-1953 CJ3A, Intake Spring [134 CI L-Head] | 17409.01 |
| 1941-1971 Models, Exhaust Spring [134 CI] | 17409.01 |
| 1952-1971 M38A1, 1953-1967 CJ3B, 1955-1971 CJ5, 1955-1971 CJ6, Intake Spring [134 CI F-Head] | 17409.02 |

| Z8. Rocker Arm Kits | Part# |
|---|----------|
| 1952-1971 M38A1, 1953-1967 CJ3B, 1955-1971 CJ5, 1955-1971 CJ6, Rocker Arm Kit, Includes Arm, Brackets & Shaft | 17411.01 |
| 1972-1991 Models, Rocker Arm Kit [5.0L, 5.9L & 6.6L], Includes 2 Arms, 2 Pivots & 1 Bridge | 17411.05 |
| 1974-1982 Models, Rocker Arm Kit [3.8L & 4.2L], Includes 2 Arms, 2 Pivots & 1 Bridge | 17411.02 |
| 1981-1986 Models, Rocker Arm Kit [4.2L], Includes 2 Arms, 2 Pivots & 1 Bridge With Stud | 17411.04 |
| 1983-1990 Models, Rocker Arm Kit [4.2L], Includes 2 Arms, 2 Pivots & 1 Bridge Without Stud | 17411.03 |

| Z9. Rocker Arms | Part# |
|--|----------|
| 1952-1971 M38A1, 1953-1967 CJ3B, 1955-1971 CJ5, 1955-1971 CJ6, Rocker Arm, Left, 2 Required | 17408.03 |
| 1952-1971 M38A1, 1953-1967 CJ3B, 1955-1971 CJ5, 1955-1971 CJ6, Rocker Arm, Right, 2 Required | 17408.04 |
| 1972-1991 Models, Rocker Arm [5.0L, 5.9L & 6.6L] | 17408.14 |
| 1974-1982 Models, Rocker Arm [3.8L & 4.2L] | 17408.07 |
| 1983-2002 Models, Rocker Arm [2.5L AMC] | 17408.06 |
| 1983-1990 Models [4.2L], 1987-2006 [4.0L], Rocker Arm | 17408.06 |

All images are subject to be representative. More detailed information is available online.



[Z13] 17410.04



[Z14] 17433.07



[Z17] 17435.01



[Z14] 17433.01



[Z16] 17436.01

[Z16] 17436.11



[Z11] 17408.02



[Z10] 17408.10



OMIX-ADA, Inc.

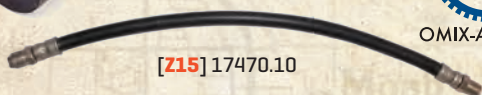

[Z15] 17470.10



[Z16] 17424.01

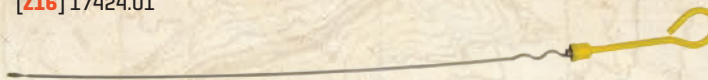

[Z16] 17424.02



[Z16] 17424.01



[Z16] 17424.04



[Z16] 17424.05

Z14. Oil Pump Screen

Part#

| | |
|---|----------|
| 1972-1980 Models, Oil Pump Screen [3.8L & 4.2L] | 17433.06 |
| 1972-1991 Models, Oil Pump Screen [5.0L, 5.9L & 6.6L] | 17433.12 |
| 1981-1990 Models, Oil Pump Screen [4.2L] | 17433.08 |
| 1997-2002 Models, Oil Pump Screen [2.5L] NEW | 17433.13 |

Z15. Oil Lines

Part#

| | |
|---|----------|
| 1941-1953 Models, Oil Line [134 CI L-Head], Inlet [25"] | 17470.06 |
| 1941-1953 Models, Oil Line [134 CI L-Head], Outlet [10"] | 17470.07 |
| 1953-1971 Models, Oil Line [134 CI F-Head], Inlet [23"] | 17470.08 |
| 1953-1971 Models, Oil Line [134 CI F-Head], Inlet [30.5"] | 17470.09 |
| 1953-1971 Models, Oil Line [134 CI F-Head], Outlet [12"] | 17470.10 |

Z16. Oil Dipsticks

Part#

| | |
|--|----------|
| 1974-1981 Models [5.0L], 1974-1979 [6.6L], Oil Dipstick | 17424.03 |
| 1974-1981 Models [5.0L], 1974-1979 [6.6L], Oil Dipstick Tube | 17424.02 |
| 1974-1981 Models [5.0L], 1974-1979 [6.6L], Oil Dipstick Kit | 17424.01 |
| 1997-1999 Wrangler [2.5L], Oil Dipstick NEW | 17424.04 |
| 1997-2006 Wrangler [4.0L], Oil Dipstick NEW | 17424.05 |

Z16. Oil Filters

Part#

| | |
|--|----------|
| 1941-1945 MB, 1941-1945 GPW, 1950-1952 M38, 1952-1971 M38A1, Oil Filter [134 CI With L-Head], Canister Style | 17436.01 |
| 1945-1949 CJ2A, 1948-1953 CJ3A, 1953-1967 CJ3B, 1955-1966 CJ5, 1955-1966 CJ6, 1946-1964 Truck, 1946-1964 Station Wagon, Oil Filter [134 CI], Canister Style | 17436.02 |
| 1945-1949 CJ2A, 1948-1953 CJ3A, 1953-1967 CJ3B, 1955-1966 CJ5, 1955-1966 CJ6, 1946-1964 Truck, 1946-1964 Station Wagon, Oil Filter Cover [134 CI With Canister Style Filter] | 17436.05 |
| 1945-1949 CJ2A, 1948-1953 CJ3A, 1953-1967 CJ3B, 1955-1966 CJ5, 1955-1966 CJ6, 1946-1964 Truck, 1946-1964 Station Wagon, Oil Canister Assembly [134 CI], Fram Style | 17436.03 |
| 1954-1964 Truck and Station Wagon, Oil Filter [226 CI], Canister Style | 17436.14 |
| 1966-1971 CJ5, 1966-1971 CJ6, Oil Filter [134 CI], Disposable Style | 17436.04 |
| 1972-1973 CJ5 [3.8L & 4.2L], 1972-1973 CJ6 [3.8L & 4.2L] | 17436.10 |
| 1972-1973 Cherokee / Grand Wagoneer [SJ] [4.2L], Oil Filter | 17436.11 |
| 1974-1980 Models, Oil Filter [3.8L, 4.2L, 5.0L, 5.9L] | 17436.11 |
| 1980-1983 [2.5L GM], 1983-1986 [2.5L AMC], Oil Filter | 17436.06 |
| 1981-1986 [4.2L], Oil Filter | 17436.12 |
| 1986-1996 [2.1L Diesel], 1987-1993 Models [2.5L], 1987-1990 [4.2L], Oil Filter [Metric Thread] | 17436.07 |
| 1991-2002 [2.5L], 1991-2006 [4.0L], 1993-1998 [5.2L], 1998 [5.8L], 1999-2008 [4.7L], 2005-Oil Filter [SAE Thread] | 17436.08 |
| 1999-2003 Export Models, Oil Filter [3.1L Diesel] | 17436.15 |
| 2002-2006 Models [2.4L], 2007-2011 [3.8L], Oil Filter NEW | 17436.09 |
| 2002-2008 Models, Oil Filter [3.7L] NEW | 17436.13 |
| 2005-2006 Liberty [2.8L Diesel], Oil Filter NEW | 17436.16 |
| 2005-2011 Models [3.0L Diesel], Oil Filter NEW | 17436.18 |
| 2008-2011 Models, Oil Filter [4.7L, 5.7L, 6.1L] NEW | 17436.17 |
| 2009-2011 Models, Oil Filter [3.7L] NEW | 17436.19 |
| 2011-2012 Models, Oil Filter [3.6L] NEW | 17436.20 |

Z17. Oil Filter Bracket

Part#

| | |
|---|----------|
| 1941-1945 MB, 1941-1945 GPW, 1945-1949 CJ2A, 1948-1953 CJ3A, 1950-1952 M38, 1946-1949 Truck, 1946-1949 Station Wagon, 1948-1949 Jeepster, Oil Filter Bracket [134 CI With L-Head] | 17435.01 |
|---|----------|

Z10. Rocker Arm Pivots

Part#

| | |
|--|----------|
| 1972-1991 Models [5.0L, 5.9L & 6.6L], 1983-2002 [2.5L AMC], 1983-1990 [4.2L], 1987-2006 [4.0L], Rocker Arm Pivot | 17408.10 |
| 1974-1982 Models, Rocker Arm Pivots [3.8L & 4.2L] | 17408.13 |

Z11. Rocker Arm Shafts

Part#

| | |
|---|----------|
| 1952-1971 M38A1, 1953-1967 CJ3B, 1955-1971 CJ5, 1955-1971 CJ6, Rocker Arm Bracket | 17408.02 |
| 1952-1971 M38A1, 1953-1967 CJ3B, 1955-1971 CJ5, 1955-1971 CJ6, Rocker Arm Shaft | 17408.05 |
| 1972-1973 Models, Rocker Arm Shaft [3.8L & 4.2L] | 17408.09 |

Z12. Rocker Arm Bridges

Part#

| | |
|--|----------|
| 1972-1991 Models [5.0L, 5.9L & 6.6L], 1983-1990 [4.2L Without Stud], 1987-2006 [4.0L], Rocker Arm Bridge | 17408.11 |
| 1981-1986 Models, Rocker Arm Bridge [4.2L], Without Stud | 17408.12 |
| 1983-2002 Models, Rocker Arm Bridge [2.5L AMC] | 17408.11 |

Z13. Push Rods

Part#

| | |
|--|----------|
| 1972-1991 Models, Push Rod [5.0L, 5.9L & 6.6L] | 17410.06 |
| 1972-1977 Models, Push Rod [3.8L & 4.2L] | 17410.02 |
| 1978-1980 Models, Push Rod [3.8L & 4.2L] | 17410.03 |
| 1981-1990 Models, Push Rod [4.2L] | 17410.04 |
| 1983-2002 Models, Push Rod [2.5L] | 17410.01 |

Z14. Oil Pump

Part#

| | |
|--|----------|
| 1941-1945 MB, 1941-1945 Ford GPW, Oil Pump [134 CI] | 17433.01 |
| 1945-1949 CJ2A, 1948-1953 CJ3A, 1953-1967 CJ3B, 1952-1971 M38A1, 1955-1971 CJ5, 1955-1971 CJ6, 1946-1964 Truck, 1946-1964 Station Wagon, Oil Pump [134 CI] | 17433.02 |
| 1954-1964 Models, Oil Pump [226 CI] | 17433.04 |
| 1972-1980 Models, High Volume Oil Pump Kit [3.8L & 4.2L], Includes Oil Pump & Screen UPGRADE | 17433.10 |
| 1972-1980 Models, Oil Pump [3.8L & 4.2L] | 17433.05 |
| 1972-1980 Models, Oil Pump Kit [3.8L & 4.2L], Includes Oil Pump & Screen | 17433.07 |
| 1972-1991 Models, Oil Pump Repair Kit [5.0L, 5.9L & 6.6L] | 17433.11 |
| 1972-1991 Models, Oil Pump Cover [5.0L, 5.9L & 6.6L] NEW | 17470.15 |
| 1972-1991 Models, Oil Pump Cover Gasket [5.0L, 5.9L & 6.6L] NEW | 17439.12 |
| 1981-1990 Models [4.2L], 1983-2002 [2.5L AMC], 1987-2006 [4.0L], Oil Pump | 17433.03 |
| 1981-1990 Models, Oil Pump Kit [4.2L], Includes Oil Pump & Screen | 17433.09 |
| 2002-2006 Models, Oil Pump [2.4L] NEW | 17433.15 |



[Z18] 17457.04



[Z20] 17453.06



[Z22] 17455.02



OMIX-ADA, Inc.



[Z19] 17452.02

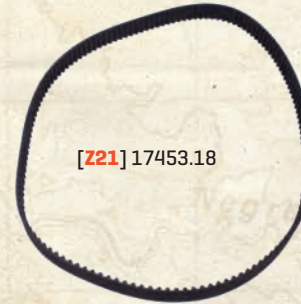

[Z21] 17453.18



[Z23] 17461.01

Z18. Timing Covers Part#

| | |
|--|----------|
| 1972-1990 (3.8L & 4.2L), 1983-1993 Models (2.5L), 1987-1992 (4.0L), Timing Cover | 17457.01 |
| 1972-1990 (3.8L & 4.2L), 1987-1992 (4.0L), Timing Cover Kit, Includes Cover & Rubber Oil Pan Gasket | 17457.07 |
| 1972-1991 Jeep Models, AMC Models: 1966 Classic, 1967-1974 Ambassador, 1967-1968 American, 1967-1970 Rebel, 1968-1979 AMX, 1968-1974 Javelin, 1969, Rambler, 1970-1977 Hornet, 1971-1978 Matador, 1972-1976 Gremlin, 1978-1979 Concord, 1978-1979 Pacer, Timing Cover (5.0L, 5.9L & 6.6L) NEW | 17457.05 |
| 1972-1991 Jeep Models, AMC Models: 1966 Classic, 1967-1974 Ambassador, 1967-1968 American, 1967-1970 Rebel, 1968-1979 AMX, 1968-1974 Javelin, 1969, Rambler, 1970-1977 Hornet, 1971-1978 Matador, 1972-1976 Gremlin, 1978-1979 Concord, 1978-1979 Pacer, Timing Cover Kit (5.0L, 5.9L & 6.6L) NEW | 17449.10 |
| 1983-1993 Models, Timing Cover Kit (2.5L), Includes Timing Cover & Rubber Oil Pan Gasket | 17457.06 |
| 1993-1999 Wrangler (4.0L), 1993-2001 Cherokee (4.0L), 1993-1999 Grand Cherokee (4.0L), 1994-2002 Wrangler (2.5L), 1994-2001 Cherokee (2.5L) Timing Cover | 17457.04 |
| 1993-1999 Wrangler (4.0L), 1993-2001 Cherokee (4.0L), 1993-1999 Grand Cherokee (4.0L), Timing Cover Kit, Includes Timing Cover & Rubber Oil Pan Gasket | 17457.03 |
| 1994-2002 Wrangler (2.5L), 1994-2001 Cherokee (2.5L) Timing Cover Kit, Includes Timing Cover & Rubber Oil Pan Gasket | 17457.02 |

Z19. Timing Chain Kits Part#

| | |
|---|----------|
| 1941-1945 MB, 1941-1945 Ford GPW, Timing Chain Kit (134 CI L-Head With Chain Driven Camshaft) | 17452.01 |
| 1945-1949 CJ2A, 1948-1953 CJ3A, 1950-1952 M38, 1952-1971 M38A1, 1953-1967 CJ3B, 1955-1971 CJ5, 1955-1971 CJ6, Timing Chain Kit (134 CI L-Head & F-Head), L-Head With Gear Driven Camshaft | 17452.02 |
| 1966-1971 Models Timing Chain Kit (225 CI) NEW | 17452.10 |
| 1972-1990 Models, Timing Chain Kit (3.8L & 4.2L) | 17452.06 |
| 1972-1986 Models, Timing Chain Kit (5.0L, 5.9L & 6.6L) | 17452.07 |
| 1979-1991 Models, Timing Chain Kit (5.9L & 6.6L) | 17452.08 |
| 1983-2002 Models, Timing Chain Kit (2.5L AMC) | 17452.03 |
| 1993-1998 Models (5.2L), 1998 (5.9L), Timing Chain Kit | 17452.09 |

Z20. Timing Chains Part#

| | |
|---|----------|
| 1941-1945 MB, 1941-1945 Ford GPW, Timing Chain (134 CI L-Head With Chain Driven Camshaft) | 17453.01 |
| 1954-1967 Truck and Station Wagon, Timing Chain (226 CI) | 17453.04 |
| 1958-1964 Truck and Station Wagon, Timing Chain (226 CI) | 17453.05 |
| 1962-1965 Models, Timing Chain (230 CI) | 17453.07 |
| 1966-1971 Models, Timing Chain (225 CI) | 17453.06 |
| 1972-1990 Models, Timing Chain (3.8L & 4.2L) | 17453.08 |
| 1972-1986 Models, Timing Chain (5.0L, 5.9L & 6.6L) | 17453.13 |
| 1979-1991 Models, Timing Chain (5.9L & 6.6L) | 17453.12 |
| 1983-2002 Models, Timing Chain (2.5L AMC) | 17453.02 |
| 1983-2002 Models, Timing Chain Tensioner (2.5L AMC) | 17453.03 |
| 1987-1993 Models, Timing Chain (4.0L) | 17453.09 |
| 1993-1998 Models (5.2L), 1998 (5.9L), Timing Chain | 17453.14 |
| 1994-2006 Models, Timing Chain (4.0L) | 17453.10 |
| 1999-2006 Models (4.7L), Timing Chain, Crankshaft Sprocket to Idler Sprocket (4.7L) | 17453.16 |
| 2002-2007 Models, Timing Chain (3.7L), 2 Required | 17453.17 |

Z21. Timing Belts & Camshaft Sprockets Part#

| | |
|---|----------|
| 2002-2006 Models, Timing Belt (2.4L) | 17453.18 |
| 1941-1945 MB, 1941-1945 Ford GPW, Camshaft Sprocket (134 CI L-Head With Chain Driven Camshaft) | 17454.01 |
| 1945-1949 CJ2A, 1948-1953 CJ3A, 1950-1952 M38, 1952-1971 M38A1, 1953-1967 CJ3B, 1955-1971 CJ5, 1955-1971 CJ6, Timing Chain Kit (134 CI L-Head & F-Head) | 17454.02 |
| 1966-1971 Models, Camshaft Sprocket (225 CI) | 17454.06 |
| 1972-1990 Models, Camshaft Sprocket (3.8L & 4.2L), Steel | 17454.07 |
| 1972-1990 Export Models, Camshaft Sprocket (3.8L & 4.2L), Nylon | 17454.08 |
| 1972-1986 Models, Camshaft Sprocket (5.0L, 5.9L & 6.6L) | 17454.11 |
| 1979-1991 Models, Camshaft Sprocket (5.9L & 6.6L) | 17454.12 |
| 1983-2002 Models, Camshaft Sprocket (2.5L AMC) | 17454.03 |
| 1987-1993 Models, Camshaft Sprocket (4.0L) | 17454.09 |
| 1993-1998 Models (5.2L), 1998 (5.9L), Camshaft Sprocket | 17454.13 |
| 1994-1998 Models, Camshaft Sprocket (4.0L) | 17454.10 |
| 1999-2006 Models, Camshaft Sprocket (4.0L) | 17454.14 |
| 1999-2006 Models, Camshaft Sprocket (4.7L), LH | 17454.15 |
| 1999-2006 Models, Camshaft Sprocket (4.7L), RH | 17454.16 |
| 1999-2009 Models (4.7L), 2002-2011 (3.7L), Camshaft Idler Sprocket NEW | 17455.14 |
| 2002-2011 Models, Camshaft Sprocket (3.7L), LH NEW | 17454.17 |
| 2002-2011 Models, Camshaft Sprocket (3.7L), RH NEW | 17454.18 |

Z22. Crankshaft Sprockets Part#

| | |
|---|----------|
| 1941-1945 MB, 1941-1945 Ford GPW, Crankshaft Sprocket (134 CI L-Head With Chain Driven Camshaft) | 17455.01 |
| 1945-1949 CJ2A, 1948-1953 CJ3A, 1950-1952 M38, 1952-1971 M38A1, 1953-1967 CJ3B, 1955-1971 CJ5, 1955-1971 CJ6, Timing Chain Kit (134 CI L-Head & F-Head) | 17455.02 |
| 1954-1967 Truck and Station Wagon, Timing Chain (226 CI) | 17455.04 |
| 1958-1964 Truck and Station Wagon, Crankshaft Sprocket (226 CI) | 17455.05 |
| 1966-1971 Models, Crankshaft Sprocket (225 CI) | 17455.06 |
| 1972-1990 Models, Crankshaft Sprocket (3.8L & 4.2L) | 17455.07 |
| 1972-1986 Models, Crankshaft Sprocket (5.0L, 5.9L & 6.6L) | 17455.10 |
| 1979-1991 Models, Crankshaft Sprocket (5.9L & 6.6L) | 17455.11 |
| 1983-2002 Models, Crankshaft Sprocket (2.5L AMC) | 17455.03 |
| 1987-1993 Models, Crankshaft Sprocket (4.0L) | 17455.08 |
| 1993-1998 Models (5.2L), 1998 (5.9L), Crankshaft Sprocket | 17455.12 |
| 1994-2006 Models, Crankshaft Sprocket (4.0L) | 17455.09 |
| 1999-2009 Models (4.9L), 2002-2011 (3.7L), Crankshaft Sprocket NEW | 17455.13 |
| 1999-2006 Models (4.7L), Timing Chain, Idler Sprocket to Camshaft Sprocket (4.7L), 2 Required | 17453.15 |

Z23. Harmonic Balancers Part#

| | |
|--|----------|
| 1972-1991, Harmonic Balancer (5.9L) | 17461.03 |
| 1972-86 Models, Harmonic Balancer (4.2L With V-Belt) | 17461.01 |
| 1987-2006 Models, Harmonic Balancer (4.0L) | 17461.02 |

All images are subject to be representative. More detailed information is available online.



OMIX-ADA, Inc.



[Z24] 17460.03



[Z26] 17474.01



[Z28] 17473.05



[Z25] 17423.03



[Z27] 17472.02



[Z28] 17472.02

Z24. Crankshaft Pulleys

| | Part# |
|--|----------|
| 1941-1945 MB, 1941-1945 GPW, 1945-1949 CJ2A, 1948-1953 CJ3A, 1950-1952 M38, 1952-1971 M38A1, 1953-1967 CJ3B, 1955-1971 CJ5, 1955-1971 CJ6, 1946-1964 Truck, 1946-1964 Station Wagon, 1948-1951 Jeepster, Crankshaft Pulley [134 CI], Single Groove | 17460.03 |
| 1941-1945 MB, 1941-1945 GPW, 1945-1949 CJ2A, 1948-1953 CJ3A, 1950-1952 M38, 1952-1971 M38A1, 1953-1967 CJ3B, 1955-1971 CJ5, 1955-1971 CJ6, 1946-1964 Truck, 1946-1964 Station Wagon, 1948-1951 Jeepster, Crankshaft Pulley [134 CI], Double Groove | 17460.01 |
| 1972-86 Models, Crankshaft Pulley [4.2L With V-Belt, Without AC], Single Groove | 17460.02 |

Z25. Distributor Drive Gears

| | Part# |
|---|----------|
| 1972-1991 Models, Distributor Drive Gear [5.0L, 5.9L, 6.6L], Camshaft Mounted | 17423.01 |
| 1972-1991 Models, Distributor Drive Gear [5.0L, 5.9L, 6.6L], Distributor Mounted | 17423.02 |
| 1972-1991 Models, Distributor Drive Gear Set [5.0L, 5.9L, 6.6L], Includes both Camshaft & Distributor Mounted Gears | 17423.03 |

Z26. Engine Mount Kits

| | Part# |
|---|----------|
| 1972-1986 Models, Engine Mounting Kit [4.2L], Includes: 2 Engine Mounts, Transmission Mount, Transmission Stabilizer Bolt & 2 Engine Stabilizer Bushings | 17474.03 |
| 1941-1971 Models, Engine Mounting Kit [134 CI], Includes: 2 Engine Mounts & Transmission Mount | 17474.01 |
| 1972-1981 Models, Engine Mounting Kit [5.0L], Includes: 2 Engine Mounts & 4 Mounting Brackets | 17472.05 |
| 1972-1981 Models, Engine Mounting Kit [5.0L], Includes: 2 Engine Mounts, Transmission Mount, Transmission Stabilizer Bolt & 2 Engine Stabilizer Bushings | 17474.05 |
| 1987-1990 Wrangler [2.5L], Engine Mounting Kit, Includes: 2 Engine Mounts, Transmission Mount, Transmission Stabilizer Bolt & 2 Engine Stabilizer Bushings | 17474.02 |
| 1987-1996 Wrangler [4.0L & 4.2L], Engine Mounting Kit, Includes: 2 Engine Mounts, Transmission Mount, Transmission Stabilizer Bolt & 2 Engine Stabilizer Bushings | 17474.04 |

Z27. Engine Mounting Brackets

| | Part# |
|--|----------|
| 1972-1981 Models, Engine Mounting Bracket [5.0L], Lower, Left | 17472.01 |
| 1972-1981 Models, Engine Mounting Bracket [5.0L], Lower, Right | 17472.02 |
| 1972-1981 Models, Engine Mounting Bracket [5.0L], Upper, Left | 17472.03 |
| 1972-1981 Models, Engine Mounting Bracket [5.0L], Upper, Right | 17472.04 |

Z28. Engine Mounts

| | Part# |
|--|----------|
| 1941-1971 Models, Engine Mount [134 CI], LH or RH | 17473.01 |
| 1941-1945 MB, 1941-1945 Ford GPW, Engine Mounting Plate [134 CI L-Head With Chain Driven Camshaft] | 17470.01 |
| 1954-1964 Models [226 CI], Engine Mount, LH or RH | 17473.05 |
| 1972-1976 Models [3.8L & 4.2L], Engine Mount, LH or RH | 17473.06 |
| 1972-1991 Models [5.0L, 5.9L & 6.6L], Engine Mounts, LH or RH | 17473.16 |
| 1972-1991 Models [5.0L, 5.9L & 6.6L], Engine Mounts, Black Polyurethane, Pair UPGRADE | 17473.18 |
| 1972-1991 Models [5.0L, 5.9L & 6.6L], Engine Mounts, Red Polyurethane, Pair UPGRADE | 17473.17 |
| 1977-1986 Models [3.8L & 4.2L], Engine Mount, LH or RH | 17473.07 |
| 1977-1986 Models [3.8L & 4.2L], Engine Mounts, Black Polyurethane, Pair UPGRADE | 17473.09 |
| 1977-1986 Models [3.8L & 4.2L], Engine Mounts, Red Polyurethane, Pair UPGRADE | 17473.08 |
| 1984-1990 Cherokee [2.5L], Engine Mount, Left | 17473.03 |
| 1984-1990 Cherokee [2.5L], Engine Mount, Right | 17473.02 |
| 1987-1990 Wrangler [2.5L], 1991-2000 Cherokee [2.5L], Engine Mount, LH or RH | 17473.03 |
| 1987-1996 Wrangler [4.0L & 4.2L], 1987-2001 Cherokee [4.0L], Engine Mount, LH or RH | 17473.10 |
| 1987-2006 Wrangler [4.0L or 4.2L], 1987-2001 Cherokee [4.0L], Engine Mounts, Black Polyurethane, Pair UPGRADE | 17473.15 |
| 1987-2006 Wrangler [4.0L or 4.2L], 1987-2001 Cherokee [4.0L], Engine Mounts, Red Polyurethane, Pair UPGRADE | 17473.14 |
| 1993-1998 Grand Cherokee [4.0L], Engine Mount, Left | 17473.13 |
| 1993-1998 Grand Cherokee [4.0L], Engine Mount, Right | 17473.12 |
| 1993-1998 Grand Cherokee [5.2L], 1998 Grand Cherokee [5.9L], Engine Mount, Left | 17473.19 |
| 1993-1998 Grand Cherokee [5.2L], 1998 Grand Cherokee [5.9L], Engine Mount, Right | 17473.20 |
| 1997-2002 Wrangler [2.5L], 2003-2006 Wrangler [2.4L], Engine Mount, LH or RH | 17473.04 |
| 1997-2006 Wrangler [4.0L], Engine Mount, LH or RH | 17473.11 |
| 1999-2004 Grand Cherokee [4.7L], Engine Mount, Left | 17473.21 |
| 1999-2004 Grand Cherokee [4.7L], Engine Mount, Right | 17473.22 |



[A] 17660.01

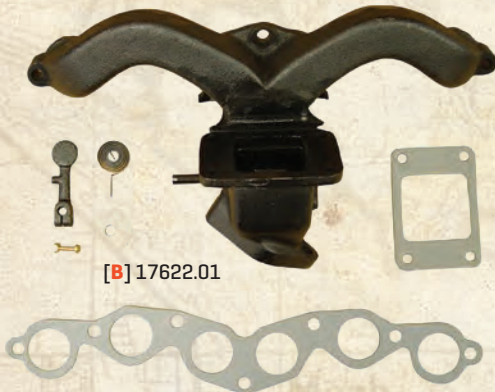

[B] 17622.01

| A. Rugged Ridge® Exhaust Headers | Part# |
|---|----------|
| 1991-1998 Wrangler, 1987-1998 Cherokee, 1993-1998 Grand Cherokee, Exhaust Header (4.0L), Black Steel | 17660.01 |
| 2000-2006 Wrangler, 2000-2001 Cherokee, 1999-2001 Grand Cherokee, Exhaust Header (4.0L), Black Steel | 17660.02 |
| 1991-1998 Wrangler, 1987-1998 Cherokee, 1993-1998 Grand Cherokee, Exhaust Header (4.0L), 409 Stainless Steel | 17650.01 |
| 2000-2006 Wrangler, 2000-2001 Cherokee, 1999-2001 Grand Cherokee, Exhaust Header (4.0L), 409 Stainless Steel | 17650.02 |
| 1991-1998 Wrangler, 1987-1998 Cherokee, 1993-1998 Grand Cherokee, Exhaust Header (4.0L), 304 Polished Stainless Steel | 17650.51 |
| 2000-2006 Wrangler, 2000-2001 Cherokee, 1999-2001 Grand Cherokee, Exhaust Header (4.0L), 304 Polished Stainless Steel | 17650.52 |
| 1991-1998 Wrangler, 1987-1998 Cherokee, 1993-1998 Grand Cherokee, Exhaust Header (4.0L), Ceramic Coated 409 Stainless Steel | 17651.01 |
| 2000-2006 Wrangler, 2000-2001 Cherokee, 1999-2001 Grand Cherokee, Exhaust Header (4.0L), Ceramic Coated 409 Stainless Steel | 17651.02 |

| B. Exhaust Manifold Kits | Part# |
|--|----------|
| 1941-1945 MB, 1941-1945 GPW, 1945-1949 CJ2A, 1948-1953 CJ3A, 1950-1952 M38, Exhaust Manifold Kit (134 CI L-Head), Includes Manifold, Hardware & Gaskets NEW | 17622.01 |
| 1952-1971 M38A1, 1953-1967 CJ3B, 1955-1971 CJ5, 1955-1971 CJ6, Exhaust Manifold Kit (134 CI F-Head), Includes Manifold & Gasket NEW | 17622.02 |
| 1972-1979 CJ5 (3.8L), 1972-1980 CJ5 (4.2L), 1972-1976 CJ6 (3.8L & 4.2L), 1976-1979 CJ7 (3.8L), 1976-1980 (4.2L), 1972-1980 Cherokee / Grand Wagoneer (SJ) (4.2L), Exhaust Manifold Kit, Includes Manifold & Gasket | 17622.05 |
| 1972-1981 CJ5 (5.0L), 1972-1976 CJ6 (5.0L), 1976-1981 (5.0L), 1972-1991 Cherokee / Grand Wagoneer (SJ) (5.0L & 5.9L), Exhaust Manifold Kit, Right, Includes Manifold & Gasket NEW | 17622.10 |
| 1972-1981 CJ5 (5.0L), 1972-1976 CJ6 (5.0L), 1976-1981 (5.0L), 1972-1991 Cherokee / Grand Wagoneer (SJ) (5.0L & 5.9L), Exhaust Manifold Kit, Left, Includes Manifold & Gasket NEW | 17622.09 |
| 1981-1983 CJ5, 1981-1986, 1981-1986 CJ8, 1987-19980 Wrangler, 1981-1990 Cherokee / Grand Wagoneer (SJ), Exhaust Manifold Kit (4.2L), Includes Manifold & Gasket | 17622.06 |
| 1984-1986 CJ7, 1984-1986 CJ8, 1987-1990 Wrangler, 1984-1990 Cherokee, Exhaust Manifold Kit (2.5L), Includes Manifold & Gasket | 17622.03 |
| 1987-1990 Cherokee, Exhaust Manifold Kit (4.0L), Includes Manifold & Gasket | 17622.07 |
| 1991-2002 Wrangler, 1991-2000 Cherokee, Exhaust Manifold Kit (2.5L), Includes Manifold & Gasket | 17622.04 |
| 1991-1998 Wrangler, 1987-1998 Cherokee, 1993-1998 Grand Cherokee, Exhaust Manifold Kit (4.0L), Includes Manifold & Gasket | 17622.08 |



[C] 17624.09

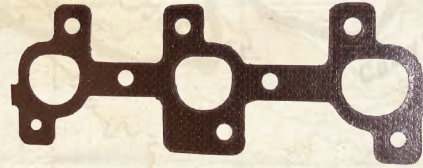

[D] 17451.14

| C. Exhaust Manifold | Part# |
|--|----------|
| 1941-1945 MB, 1941-1945 GPW, 1945-1949 CJ2A, 1948-1953 CJ3A, 1950-1952 M38, Exhaust Manifold (134 CI L-Head) | 17624.01 |
| 1941-1945 MB, 1941-1945 GPW, 1945-1949 CJ2A, 1948-1953 CJ3A, 1950-1952 M38, Exhaust Manifold Hardware Kit (134 CI L-Head) | 17625.01 |
| 1941-1945 MB, 1941-1945 GPW, 1945-1949 CJ2A, 1948-1953 CJ3A, 1950-1952 M38, Exhaust Manifold Spring (134 CI L-Head) NEW | 17625.02 |
| 1952-1971 M38A1, 1953-1967 CJ3B, 1955-1971 CJ5, 1955-1971 CJ6, Exhaust Manifold (134 CI F-Head) | 17624.02 |
| 1972-1979 CJ5 (3.8L), 1972-1980 CJ5 (4.2L), 1972-1976 CJ6 (3.8L & 4.2L), 1976-1979 CJ7 (3.8L), 1976-1980 (4.2L), 1972-1980 Cherokee / Grand Wagoneer (SJ) (4.2L), Exhaust Manifold | 17624.06 |
| 1972-1981 CJ5 (5.0L), 1972-1976 CJ6 (5.0L), 1976-1981 (5.0L), 1972-1991 Cherokee / Grand Wagoneer (SJ) (5.0L & 5.9L), Exhaust Manifold, Left NEW | 17624.13 |
| 1972-1981 CJ5 (5.0L), 1972-1976 CJ6 (5.0L), 1976-1981 (5.0L), 1972-1991 Cherokee / Grand Wagoneer (SJ) (5.0L & 5.9L), Exhaust Manifold, Right NEW | 17624.12 |
| 1981-1983 CJ5, 1981-1986, 1981-1986 CJ8, 1987-19980 Wrangler, 1981-1990 Cherokee / Grand Wagoneer (SJ), Exhaust Manifold(4.2L) | 17624.07 |
| 1984-1986 CJ7, 1984-1986 CJ8, 1987-1990 Wrangler, 1984-1990 Cherokee, Exhaust Manifold (2.5L) | 17624.03 |
| 1991-2002 Wrangler, 1991-2000 Cherokee, Exhaust Manifold(2.5L) | 17624.05 |
| 1987-1990 Cherokee, Exhaust Manifold (4.0L) | 17624.08 |
| 1991-1998 Wrangler, 1987-1998 Cherokee, 1993-1998 Grand Cherokee, Exhaust Manifold Kit (4.0L) | 17624.09 |
| 1999-2004 Grand Cherokee (4.7L), Exhaust Manifold (4.7L), Left | 17624.15 |
| 1999-2004 Grand Cherokee (4.7L), Exhaust Manifold (4.7L), Right | 17624.14 |
| 2000-2006 Wrangler, 2000-2001 Cherokee, 1999-2001 Grand Cherokee, Exhaust Manifold (4.0L), Front | 17624.10 |
| 2000-2006 Wrangler, 2000-2001 Cherokee, 1999-2001 Grand Cherokee, Exhaust Manifold (4.0L), Rear | 17624.11 |

| D. Exhaust Manifold Gaskets | Part# |
|--|----------|
| 1941-1945 MB, 1941-1945 GPW, 1945-1949 CJ2A, 1948-1953 CJ3A, 1950-1952 M38, Exhaust Manifold Gasket | 17451.01 |
| 1952-1971 M38A1, 1953-1967 CJ3B, 1955-1971 CJ5, 1955-1971 CJ6, Exhaust Manifold Gasket | 17451.02 |
| 1966-1971 CJ5, 1966-1971 CJ6, Exhaust Manifold Gasket (225 CI) | 17450.10 |
| 1972-1979 CJ5 (3.8L), 1972-1980 CJ5 (4.2L), 1972-1976 CJ6 (3.8L & 4.2L), 1976-1979 CJ7 (3.8L), 1976-1980 (4.2L) CJ7, 1972-1980 Cherokee / Grand Wagoneer (SJ) (4.2L), Exhaust Manifold | 17451.03 |
| 1972-1981 CJ5 (5.0L), 1972-1976 CJ6 (5.0L), 1976-1981 (5.0L), 1972-1991 Cherokee / Grand Wagoneer (SJ) (5.0L & 5.9L), Exhaust Manifold Gasket | 17451.08 |
| 1981-1983 CJ5, 1981-1986, 1981-1986 CJ8, 1987-19980 Wrangler, 1981-1990 Cherokee / Grand Wagoneer (SJ), Exhaust Manifold Gasket (4.2L) | 17451.04 |
| 1984-1986 CJ7, 1984-1986 CJ8, 1987-1990 Wrangler, 1984-1990 Cherokee, Exhaust Manifold Gasket (2.5L) | 17451.10 |
| 1987-1990 Cherokee, Exhaust Manifold Gasket (4.0L) | 17451.05 |
| 1991-1998 Wrangler, 1987-1998 Cherokee, 1993-1998 Grand Cherokee, Exhaust Manifold Gasket (4.0L) | 17451.06 |
| 1999-2007 Grand Cherokee, Exhaust Manifold Gasket Set (4.7L) | 17450.12 |
| 2000-2006 Wrangler, 2000-2001 Cherokee, 1999-2001 Grand Cherokee, Exhaust Manifold Gasket (4.0L) NEW | 17451.11 |
| 2002-2007 Liberty, 2005-2007 Grand Cherokee, Exhaust Manifold Gasket (3.7L), Left | 17451.14 |
| 2002-2007 Liberty, 2005-2007 Grand Cherokee, Exhaust Manifold Gasket (3.7L), Right | 17451.13 |
| 2002-2007 Liberty, 2005-2007 Grand Cherokee, Exhaust Manifold Gasket Set (3.7L) NEW | 17451.15 |
| 2003-2006 Wrangler, 2002-2005 Liberty, Exhaust Manifold Gasket (2.4L) | 17451.12 |
| 2007-2011 Wrangler, Exhaust Manifold Gasket Set (3.8L) NEW | 17451.16 |

All images are subject to be representative. More detailed information is available online.

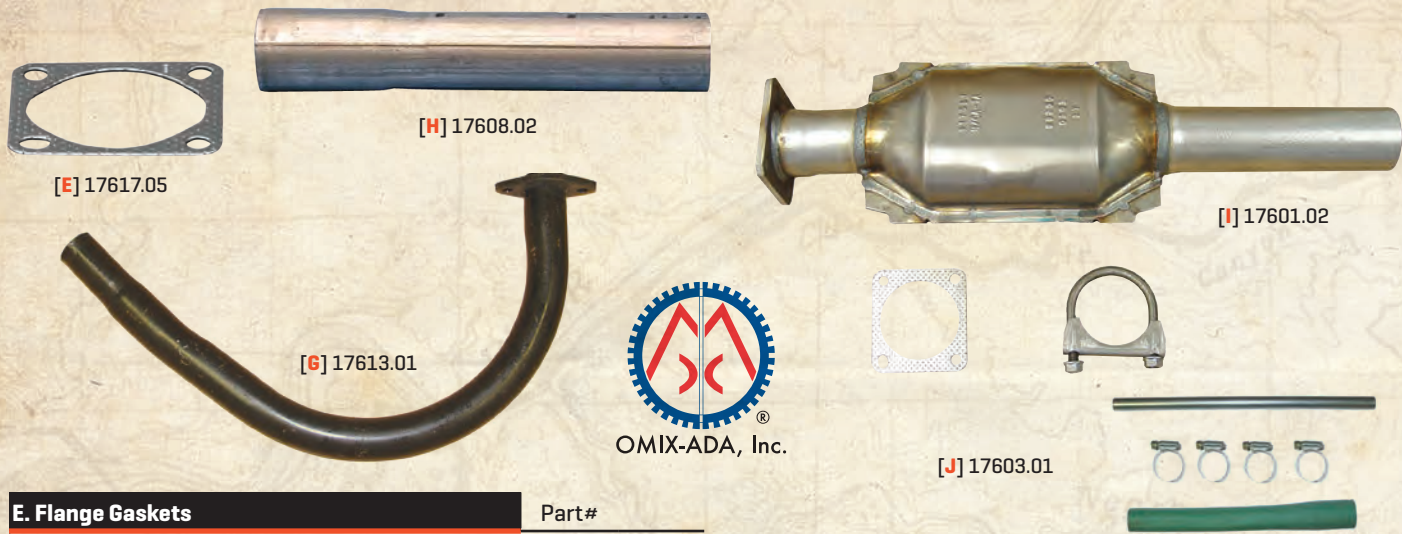

E. Flange Gaskets

| Part# | Part# |
|---|----------|
| 1945-1949 CJ2A, 1948-1953 CJ3A, 1953-1967 CJ3B, 1955-1971 CJ5, 1955-1971 CJ6, Exhaust Flange Gasket [134 CI] | 17450.01 |
| 1954-1964 Truck & Station Wagon, Exhaust Flange Gasket [226 CI] NEW | 17450.06 |
| 1972-1979 CJ5 (3.8L), 1972-1980 CJ5 (4.2L), 1972-1976 CJ6 (3.8L & 4.2L), 1976-1979 CJ7 (3.8L), 1976-1986(4.2L) CJ7, 1981-1986 CJ8 (4.2L), 1987-1990 Wrangler (4.2L), 1972-1980 Cherokee / Grand Wagoneer (SJ) (4.2L), Exhaust Flange Gasket | 17450.02 |
| 1972-1981 CJ5 (5.0L), 1972-1976 CJ6 (5.0L), 1976-1981 (5.0L), 1972-1991 Cherokee / Grand Wagoneer (SJ) (5.0L, 5.9L & 6.6L), Exhaust Flange Gasket | 17450.03 |
| 1987-1995 Wrangler, Flange gasket (2.5L, 4.0L & 4.2L), Head Pipe to Converter Gasket | 17617.05 |
| 1991-2000 Wrangler, 1991-2000 Cherokee, 1993-1998 Grand Cherokee, Exhaust Flange Gasket (4.0L) | 17450.04 |
| 2000-2006 Wrangler, Exhaust Flange Gasket (4.0L) NEW | 17617.06 |

F. Exhaust Kit

| Part# | Part# |
|--|----------|
| 1945-1949 CJ2A, 1948-1953 CJ3A, 1953-1967 CJ3B, 1955-1971 CJ5, 1955-1971 CJ6, Exhaust Kit [134CI], Includes: Head Pipe, Intermediate Pipe, Tail Pipe & Muffler | 17606.11 |

G. Head Pipe

| Part# | Part# |
|---|----------|
| 1945-1949 CJ2A, 1948-1953 CJ3A, 1953-1967 CJ3B, 1955-1971 CJ5, 1955-1971 CJ6, Head Pipe [134CI] | 17613.01 |
| 1972-1978 CJ5, Head Pipe (3.8L & 4.2L) | 17613.05 |
| 1972-1978 CJ7, Head Pipe (3.8L & 4.2L) | 17613.06 |
| 1976-1978 CJ7, Y-Pipe (5.0L With MT) | 17613.12 |
| 1983-1986 CJ7, 1983-1986 Head Pipe (4.2L) | 17613.07 |
| 1984-1986 Cherokee, Head Pipe (2.5L) | 17613.03 |
| 1984-1986 Cherokee, Head Pipe (2.8L) | 17613.15 |
| 1987-1992 Wrangler, Head Pipe (2.5L) | 17613.02 |
| 1987-1990 Wrangler, Head Pipe (4.2L) | 17613.08 |
| 1987-1992 Cherokee, Head Pipe (2.5L) | 17613.04 |
| 1987-1990 Cherokee, Head Pipe (4.0L) | 17613.10 |
| 1991-1992 Wrangler, Head Pipe (4.0L) | 17613.09 |
| 1991-1992 Cherokee, Head Pipe (4.0L) | 17613.11 |
| 1993-1995 Wrangler, Head Pipe (2.5L) | 17613.19 |
| 1993-1995 Cherokee, Head Pipe (2.5L) | 17613.16 |
| 1993-1995 Cherokee, Head Pipe (4.0L) | 17613.17 |
| 1996-1998 Cherokee, Head Pipe (4.0L) | 17613.18 |
| 1993-1995 Grand Cherokee, Y-Pipe (5.2L) | 17613.13 |
| 1996-1998 Grand Cherokee (5.2L), 1998 Grand Cherokee (5.9L), Y-Pipe | 17613.20 |
| 2000 Wrangler, Y-Pipe (4.0L) NEW | 17613.21 |
| 2000 Wrangler, Y-Pipe (4.0L), With Catalytic Converter NEW | 17613.24 |
| 2001-2003 Wrangler, Y-Pipe (4.0L), With Front Catalytic Converters NEW | 17613.22 |
| 2004-2006 Wrangler, Y-Pipe (4.0L), With Front Catalytic Converters NEW | 17613.23 |

H. Intermediate Pipe

| Part# | Part# |
|---|----------|
| 1945-1949 CJ2A, 1948-1953 CJ3A, 1953-1967 CJ3B, 1955-1971 CJ5, 1955-1971 CJ6, Intermediate Pipe [134CI] | 17608.01 |
| 1981 CJ8, Intermediate Pipe (2.5L GM, 4.2L & 5.0L) | 17608.02 |
| 2000-2001 Cherokee, Intermediate Pipe (4.0L) | 17608.03 |

I. Catalytic Converter Kits

| Part# | Part# |
|---|----------|
| 1975-1978 CJ5, 1975-1978 CJ7, Catalytic Converter (3.8L, 4.2L & 5.0L) + | 17601.04 |
| 1981-1983 CJ5, 1981-1986 CJ7, 1981-1986 CJ8, Catalytic Converter (4.2L) * | 17601.01 |
| 1984-1986 CJ7, 1984-1986 CJ8, Catalytic Converter (2.5L), With Air Tube Hole * | 17601.01 |
| 1987-1992 Wrangler, Catalytic Converter (2.5L) | 17601.02 |
| 1987-1990 Wrangler (4.2L), 1984-1985 Cherokee (2.5L), Catalytic Converter, With Air Tube Hole * | 17601.05 |
| 1991-1992 Wrangler, Catalytic Converter (4.0L) + | 17601.02 |
| 1993-1995 Wrangler, Catalytic Converter (2.5L) + | 17601.03 |
| 1993-1995 Wrangler (4.0L) 1993-1995 Cherokee (2.5L & 4.0L), Catalytic Converter + | 17601.03 |

J. Catalytic Converters

| Part# | Part# |
|--|----------|
| 1974-1991 Cherokee / Grand Wagoneer (SJ) (5.0L, 5.9L & 6.6L), Catalytic Converter + | 17604.06 |
| 1975-1978 CJ5, 1975-1978 CJ7, Catalytic Converter (3.8L, 4.2L & 5.0L) + | 17604.05 |
| 1979-1983 CJ5, 1979-1983 CJ7, 1981-1983 CJ8, Catalytic Converter (2.5L GM, 3.8L, 4.2L & 5.0L), Without Air Tube + | 17604.11 |
| 1984-1986 CJ7 (2.5L), 1984-1986 CJ8 (2.5L), 1981-1986 CJ7 (4.2L), 1981-1986 CJ8 (4.2L) Catalytic Converter, With Air Tube * | 17604.01 |
| 1984-1986 Cherokee, Catalytic Converter (2.8L) + | 17604.12 |
| 1987-1992 Wrangler, Catalytic Converter (2.5L) + | 17604.03 |
| 1987-1990 Wrangler (4.2L), 1984-1985 Cherokee (2.5L), 1981-1986 Cherokee/ Grand Cherokee (SJ) (4.2L) Catalytic Converter, With Air Tube Hole * | 17604.01 |
| 1987-1990 Wrangler (4.2L), 1984-1985 Cherokee (2.5L), Catalytic Converter, With Air Tube Hole * | 17604.02 |
| 1991-1992 Wrangler, 1991-1992 Cherokee, Catalytic Converter (4.0L) | 17604.03 |
| 1993-1995 Wrangler, Catalytic Converter (2.5L) + | 17604.04 |
| 1993-1995 Wrangler (4.0L) 1993-1995 Cherokee (2.5L & 4.0L), 1993-1995 Grand Cherokee (4.0L), Catalytic Converter + | 17604.04 |
| 1994-1995 Grand Cherokee, Catalytic Converter (5.2L) + | 17604.07 |
| 1996-2000 Cherokee (2.5L), 1996-2001 Cherokee (4.0L) 1996-1999-2001 Grand Cherokee (4.7L), Catalytic Converter + | 17604.08 |
| 1996-1998 Grand Cherokee (5.2L), 1998 Grand Cherokee (5.9L) Catalytic Converter + | 17604.08 |
| 1997-2000 Wrangler, Catalytic Converter (2.5L & 4.0L) + | 17604.10 |
| 1984-1986 CJ7, 1984-1986 CJ8, 1987-1990 Wrangler, Air Tube Conversion Kit, (For 17601.01, 17601.05, 17604.01 & 17604.02) Catalytic Converters) + | 17603.01 |
| 2000 Wrangler, Head Pipe (4.0L), With Catalytic Converter NEW + | 17613.24 |
| 2001-2003 Wrangler, Y-Pipe (4.0L), With Front Catalytic Converters NEW + | 17613.22 |
| 2002-2004 Wrangler, Catalytic Converter (4.0L) NEW + | 17604.15 |
| 2004-2006 Wrangler, Y-Pipe (4.0L), With Front Catalytic Converters NEW + | 17613.23 |

* Requires Separate Air Tube Conversion Kit No. 17603.01, EPA Certified in 49 States + EPA Certified in 49 States • After 1-24-00, EPA Certified in 49 States



OMIX-ADA, Inc.



[K] 17609.03



[M] 17606.03

| K. Mufflers | Part# |
|---|----------|
| 1941-1945 MB, 1941-1945 Ford GPW, Muffler [134 CI], Oval | 17609.01 |
| 1945-1949 CJ2A, 1948-1953 CJ3A, 1953-1967 CJ3B, 1955-1971 CJ5, 1955-1971 CJ6, Muffler [134 CI], Round | 17609.02 |
| 1966-1971 CJ5, 1966-1971 CJ6, Muffler [225 CI] | 17609.09 |
| 1972-1978 CJ5 (3.8L & 4.2L), 1972-1975 CJ5 (5.0L) 1972-1975 CJ6 (3.8L, 4.2L & 5.0L), 1976-1978 CJ7 (3.8L & 4.2L), Muffler, For Models Without Catalytic Converters | 17609.10 |
| 1976-1979 CJ5 (3.8L), 1976-1981 CJ5 (4.2L & 5.0L), 1980-1983 CJ5 (2.5L GM), 1976-1979 CJ7 (3.8L), 1976-1981 CJ (4.2L & 5.0L), 1980-1983 CJ7 (2.5L GM), 1981-1983 CJ8 (2.5L GM), 1981 CJ8 (4.2L & 5.0L), Muffler, For Models With Catalytic Converters | 17609.03 |
| 1979-1987 J10 / J20 Truck, Muffler [5.0L & 5.9L] | 17609.13 |
| 1981-1991 Cherokee / Grand Cherokee (Sj), Muffler [5.9L] | 17609.14 |
| 1983 CJ5, 1983-1986 CJ7, 1983-1986 CJ8, Muffler [2.5L AMC, 3.8L & 4.2L], For Models With Catalytic Converters | 17609.04 |
| 1984-1986 Cherokee, Muffler [2.8L] | 17609.12 |
| 1986-1989 Cherokee, Muffler [2.5L] | 17609.07 |
| 1987-1992 Wrangler, Muffler [2.5L] | 17609.05 |
| 1987-1990 Wrangler, Muffler [4.2L] | 17609.16 |
| 1987-1992 Cherokee, Muffler [4.0L] | 17609.11 |
| 1991-1992 Wrangler, Muffler [4.0L] | 17609.05 |
| 1993-1995 Wrangler, Muffler [2.5L] | 17609.06 |
| 1993-1995 Cherokee, Muffler [2.5L & 4.0L] | 17609.08 |
| 1993-1995 Grand Cherokee, Muffler [5.2L] | 17609.15 |
| 1996-1998 Cherokee, Muffler [4.0L] | 17609.19 |
| 1996-1998 Grand Cherokee, Muffler [4.0L] | 17609.20 |
| 1997-2002 Wrangler, Muffler [2.5L] | 17609.17 |
| 2000-2006 Wrangler, Muffler [After 1-24-00] NEW * | 17609.24 |
| 2002-2007 Liberty, Muffler [2.7L, 2.8L Diesel & 3.7L] NEW | 17609.25 |
| 2005-2009 Grand Cherokee, Muffler [3.7L & 4.7L] NEW | 17609.23 |

| L. Tailpipes | Part# |
|---|----------|
| 1945-1949 CJ2A, 1948-1953 CJ3A, 1953-1967 CJ3B, 1955-1971 CJ5, 1955-1971 CJ6, Tailpipe [134 CI] | 17615.01 |
| 1972-1978 CJ5 (3.8L & 4.2L), 1972-1975 CJ5 (5.0L) 1972-1975 CJ6 (3.8L, 4.2L & 5.0L), 1976-1978 CJ7 (3.8L & 4.2L), Tailpipe, For Models Without Catalytic Converters | 17615.08 |
| 1966-1971 CJ5, 1966-1971 CJ6, Tailpipe [225 CI] | 17615.07 |
| 1972-1978 CJ5 (3.8L & 4.2L), 1972-1975 CJ5 (5.0L) 1972-1975 CJ6 (3.8L, 4.2L & 5.0L), 1976-1978 CJ7 (3.8L & 4.2L), Tailpipe, For Models Without Catalytic Converters | 17615.09 |
| 1976-1979 CJ5 (3.8L), 1976-1981 CJ5 (4.2L & 5.0L), 1980-1983 CJ5 (2.5L GM), 1976-1979 CJ7 (3.8L), 1976-1981 CJ (4.2L & 5.0L), 1980-1983 CJ7 (2.5L GM), 1981-1983 CJ8 (2.5L GM), 1981 CJ8 (4.2L & 5.0L), Muffler, For Models With Catalytic Converters | 17615.02 |
| 1983 CJ5, 1983-1986 CJ7, 1983-1986 CJ8, Tailpipe [2.5L AMC, 3.8L & 4.2L], For Models With Catalytic Converters | 17615.03 |
| 1984-1985 Cherokee [2.5L], 1984-1986 Cherokee [2.8L], Tailpipe | 17615.12 |
| 1986-1992 Cherokee [2.5L], 1987-1992 Cherokee [4.0L] Tailpipe | 17615.05 |
| 1987-1995 Wrangler [2.5L, 4.0L & 4.2L], Tailpipe | 17615.04 |
| 1993-1995 Cherokee, Tailpipe [2.5L & 4.0L] | 17615.06 |
| 1993-1995 Grand Cherokee, Tailpipe [4.0L] | 17615.10 |
| 1993-1995 Grand Cherokee, Tailpipe [5.2L] | 17615.11 |
| 1996-1998 Cherokee [4.0L], 1997-2000 Cherokee [2.5L], Tailpipe | 17615.13 |
| 1996-1997 Grand Cherokee, Tailpipe [4.0L] | 17615.14 |
| 1996-1998 Grand Cherokee [5.2L], 1998 Grand Cherokee [5.9L], Tailpipe | 17615.15 |
| 1997-2000 Wrangler, Tailpipe [2.5L & 4.0L] | 17615.17 |
| 1999-2004 Grand Cherokee, Tailpipe [4.7L] | 17615.16 |
| 2000-2006 Wrangler, Tailpipe [After 1-24-00] NEW * | 17615.22 |
| 2002-2007 Liberty, Tailpipe [2.7L, 2.8L Diesel & 3.7L] NEW | 17615.23 |
| 2005-2009 Grand Cherokee, Tailpipe [3.7L & 4.7L] NEW | 17615.21 |



[L] 17615.07



[N] 17620.05



[N] 17620.03



[O] 17620.09

| M. Muffler & Tailpipe Kits | Part# |
|--|----------|
| 1972-1975 CJ5, Muffler & Tailpipe Kit [3.8L, 4.2L & 5.0L] | 17606.03 |
| 1976-1978 CJ5, 1976-1978 CJ7 Muffler & Tailpipe Kit [3.8L & 4.2L] | 17606.04 |
| 1976-1981 CJ5, 1979-1981 CJ7 Muffler & Tailpipe Kit [5.0L] | 17606.10 |
| 1979-1981 CJ5, 1979-1981 CJ7 Muffler & Tailpipe Kit [3.8L & 4.2L], For Models With Catalytic Converters | 17606.05 |
| 1981 CJ8, Muffler & Tailpipe Kit [2.5L GM, 4.2L & 5.0L] | 17606.06 |
| 1982-1983 CJ5, 1982-1986 CJ7, Muffler & Tailpipe Kit [3.8L & 4.2L], For Models With Catalytic Converters | 17606.07 |
| 1983-1986 CJ8, Muffler & Tailpipe Kit [2.5L GM, 2.5L AMC & 4.2L] | 17606.06 |
| 1987-1992 Wrangler, Muffler & Tailpipe Kit [2.5L] | 17606.01 |
| 1987-1990 Wrangler, Muffler & Tailpipe Kit [4.2L] | 17606.09 |
| 1991-1992 Wrangler, Muffler & Tailpipe Kit [4.0L] | 17606.01 |
| 1993-1995 Wrangler, Muffler & Tailpipe Kit [2.5L] | 17606.02 |
| 1993-1995 Wrangler, Muffler & Tailpipe Kit [4.0L] | 17606.02 |
| 2000-2006 Wrangler, Muffler & Tailpipe [After 1-24-00] NEW * | 17611.09 |
| 2002-2007 Liberty, Muffler & Tailpipe [2.7L, 2.8L Diesel & 3.7L] NEW | 17611.10 |
| 2005-2009 Grand Cherokee, Muffler & Tailpipe [3.7L & 4.7L] NEW | 17611.08 |

| N. Exhaust Hangers | Part# |
|--|----------|
| Universal, Exhaust Hanger, Swivel Style [9.5" Long] | 17620.01 |
| Universal, Exhaust Hanger | 17620.02 |
| Universal, Exhaust Bracket | 17620.03 |
| Universal, Exhaust Insulator Bracket With Rubber Insulator | 17620.04 |
| Universal, Exhaust Insulator, Oval Rubber | 17620.05 |

| O. Exhaust Clamps | Part# |
|--|----------|
| Universal, Exhaust Clamp [2"] | 17620.06 |
| Universal, Exhaust Clamp [2"], Heavy Duty UPGRADE | 17620.09 |
| Universal, Exhaust Clamp [2-1/8"] | 17620.07 |
| Universal, Exhaust Clamp [2-1/4"] | 17620.08 |
| Universal, Exhaust Clamp [2-1/4"], Heavy Duty UPGRADE | 17620.10 |
| Universal, Exhaust Clamp [2-1/4"], Stainless Steel UPGRADE | 17620.13 |
| Universal, Exhaust Clamp [2-1/2"], Heavy Duty UPGRADE | 17620.11 |
| Universal, Exhaust Clamp [2-1/2"], Stainless Steel UPGRADE | 17620.12 |
| Universal, Exhaust Clamp [2.75"], Band Clamp, Stainless Steel NEW | 17620.14 |

All images are subject to be representative. More detailed information is available online.

* Except 2004-2006 Wrangler Unlimited

Fuel

NOTICE Performance or EMPI carburetor kit may affect or require readjustment of emissions equipped vehicles. Check emissions requirements before use on-road.



[A] 17701.02

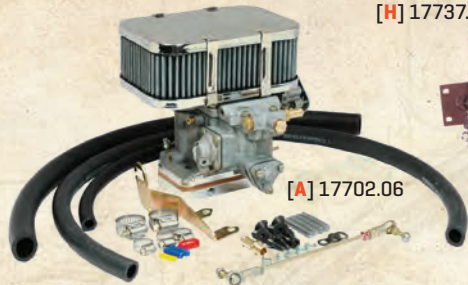

[A] 17702.06

[H] 17737.09



[B] 17704.04



[C] 17705.08



[E] 17733.01



[G] 17736.01



[F] 17735.02

[D] 17716.07

A. Carburetors

Part#

| | |
|---|----------|
| 1941-1945 MB, 1941-1945 GPW, 1945-1949 CJ2A, 1948-1953 CJ3A, 1950-1952 M38, Solex 1-Barrel Carburetor (For 134 CI With L-Head) | 17701.01 |
| 1945-1949 CJ2A, 1948-1953 CJ3A, 1953-1967 CJ3B, 1955-1971 CJ5, 1955-1971 CJ6, Carter 1-Barrel Carburetor YF (134 CI), 32/36mm DGEV Webber Design UPGRADE | 17702.01 |
| 1952-1971 M38A1, 1953-1967 CJ3B, 1955-1971 CJ5, 1955-1971 CJ6, Solex 1-Barrel Carburetor (For 134 CI With F-Head) | 17701.02 |
| 1972-1978 CJ5 (3.8L & 4.2L), 1972-1975 CJ6 (3.8L & 4.2L), 1976-1978 CJ7 (3.8L & 4.2L), Carter 1-Barrel Carburetor (YF), 32/36mm DGEV Webber Design UPGRADE | 17702.05 |
| 1972-1983 CJ5 (4.2L), 1976-1986 CJ7 (3.8L & 4.2L), 1981-1986 CJ8 (4.2L), 1987-1990 Wrangler (4.2L), Carter 2-Barrel Carburetor (YF), 34mm DGEV Webber Design (300 CFM) UPGRADE | 17702.06 |
| 1972-1983 CJ5 (4.2L), 1976-1986 CJ7 (3.8L & 4.2L), 1981-1986 CJ8 (4.2L), 1987-1990 Wrangler (4.2L), Carter 2-Barrel Carburetor YF, 34mm DGEV EMPI Design (300 CFM) UPGRADE | 17702.08 |
| 1972-1983 CJ5 (4.2L), 1976-1986 CJ7 (3.8L & 4.2L), 1981-1986 CJ8 (4.2L), 1987-1990 Wrangler (4.2L), Carter 2-Barrel Carburetor (YF), 38mm DGEV Webber Design (400 CFM) UPGRADE | 17702.07 |
| 1980-1983 CJ5 (2.5L GM), 1980-1983 CJ7 (2.5L GM), 1981-1983 CJ8 (2.5L GM), 1984-1986 Cherokee (2.8L), Rochester 2-Barrel Carburetor, 32/36mm DGEV Webber Design UPGRADE | 17702.03 |
| 1980-1983 CJ5 (2.5L GM), 1980-1983 CJ7 (2.5L GM), 1981-1983 CJ8 (2.5L GM), 1984-1986 Cherokee (2.8L), Rochester 2-Barrel Carburetor (E-2SE), 38mm Webber Design UPGRADE | 17702.02 |
| 1983 CJ5 (2.5L AMC), 1983-1986 CJ7 (2.5L AMC), 1983-1986 CJ8 (2.5L AMC), 1987-1988 Wrangler (2.5L), Carter 1-Barrel Carburetor (YF), 32/36mm DGEV Webber Design UPGRADE | 17702.04 |

B. Carburetor Components

Part#

| | |
|--|----------|
| Carburetor Base Plate Adapter, For 17702.06 Carburetor | 17704.03 |
| Carburetor Air Filter Adapter Base, for Webber Style Air Cleaner, Fits 17702.01, 17702.02, 17702.03, 17702.04, 17702.05, 17702.06 & 17702.07 Carburetors | 17704.02 |
| Carburetor Air Filter Adapter, Converts 32-36 DGEV Base to 5-1/8" Base, Fits 17702.01, 17702.02, 17702.03, 17702.04, 17702.05, 17702.06 & 17702.07 Carburetors | 17704.01 |
| Air Filter Assembly, for Webber Style Carburetors, Fits 17702.01, 17702.02, 17702.03, 17702.04, 17702.05, 17702.06 & 17702.07 | 17704.04 |
| Air Filter, for Webber Style Carburetors, Fits 17702.01, 17702.02, 17702.03, 17702.04, 17702.05, 17702.06 & 17702.07 | 17704.05 |

C. Carburetor Rebuild & Service Kits

Part#

| | |
|--|----------|
| 1941-1945 MB, 1941-1945 GPW, 1945-1949 CJ2A, 1948-1953 CJ3A, Carburetor Service Kit, (134 CI With L-Head), For Carter 1-Barrel | 17705.03 |
| 1941-1945 MB, 1941-1945 GPW, 1945-1949 CJ2A, 1948-1953 CJ3A, 1950-1952 M38, Carburetor Service Kit, (134 CI With L-Head), For Solex 1-Barrel PN 17701.01 | 17705.01 |
| 1941-1945 MB, 1941-1945 GPW, 1945-1949 CJ2A, 1948-1953 CJ3A, 1950-1952 M38, Carburetor Rebuild Kit, (134 CI With L-Head), For Carter 1-Barrel | 17705.04 |
| 1941-1945 MB, 1941-1945 GPW, 1945-1949 CJ2A, 1948-1953 CJ3A, 1950-1952 M38, Carburetor Base Gasket, (134 CI With L-Head), For Carter 1-Barrel | 17706.01 |
| 1950-1952 M38, Carburetor Rebuild Kit, (134 CI With L-Head), For Carter 1-Barrel | 17705.07 |
| 1952-1971 M38A1, Carburetor Service Kit, (134 CI With F-Head), For Carter 1-Barrel | 17705.08 |
| 1952-1971 M38A1, 1953-1967 CJ3B, 1955-1971 CJ5, 1955-1971 CJ6, Carburetor Service Kit, (134 CI With F-Head), For Solex 1-Barrel PN 17701.01 | 17705.02 |
| 1953-1967 CJ3B, 1955-1971 CJ5, 1955-1971 CJ6, Carburetor Service Kit, (134 CI With F-Head), For Carter 1-Barrel | 17705.05 |
| 1953-1967 CJ3B, 1955-1971 CJ5, 1955-1971 CJ6, Carburetor Rebuild Kit, (134 CI With F-Head), For Carter 1-Barrel | 17705.06 |
| 1975-1980 CJ5 (3.8L & 4.2L), 1975 CJ6 (3.8L & 4.2L), 1976-1980 CJ7 (3.8L & 4.2L), Carburetor Service Kit, For Carter 1-Barrel | 17705.09 |
| 1975-1980 CJ5 (3.8L & 4.2L), 1975 CJ6 (3.8L & 4.2L), 1976-1980 CJ7 (3.8L & 4.2L), Carburetor Service Kit, For Carter 2-Barrel | 17705.10 |
| Carburetor Gasket Service Kit for 17702.07 | 17703.02 |
| Carburetor Gasket Service Kit for 17702.04, 17702.05 & 17702.06 | 17703.01 |

D. Accelerator Cables

Part#

| | |
|---|----------|
| 1972-1975 CJ5 (3.8L & 4.2L), 1972-1975 CJ6 (3.8L & 4.2L), Accelerator Cable (27.75") | 17716.04 |
| 1972-1975 CJ5 (5.0L), 1972-1975 CJ6 (5.0L), Accelerator Cable (35.38") | 17716.11 |
| 1976-1978 CJ5 (3.8L & 4.2L), 1976-1978 CJ7 (3.8L & 4.2L), Accelerator Cable (30.5") | 17716.05 |
| 1976 CJ5 (5.0L), 1976 CJ7 (5.0L), Accelerator Cable (21.25") | 17716.12 |
| 1976-1981 CJ5, 1976-1986 CJ7, 1981-1986 CJ8, 1987-1995 Wrangler, Accelerator Cable Bracket, For Fiberglass Bodies | 17737.20 |
| 1977-1981 CJ5 (5.0L), 1977-1981 CJ7 (5.0L), 1981 CJ8, Accelerator Cable (18.75") | 17716.13 |
| 1977-1980 Cherokee (4.2L), Accelerator Cable | 17716.10 |
| 1979 CJ5 (3.8L), 1979-1980 CJ5 (4.2L), 1979 CJ7 (3.8L), 1979-1980 CJ7 (4.2L), 1981 CJ5 & CJ7 (Export Models), Accelerator Cable | 17716.06 |
| 1980-1983 CJ5 (2.5L GM), 1980-1983 CJ7 (2.5L GM), 1981-1983 CJ8 (2.5L GM), 1984-1986 Cherokee (2.8L), Accelerator Cable | 17716.01 |
| 1981-1986 CJ5 (4.2L), 1981-1986 CJ7 (4.2L), 1981-1986 CJ8 (4.2L), Accelerator Cable (24.25") | 17716.07 |
| 1984-1986 Cherokee (2.8L), Accelerator Cable | 17716.08 |
| 1987-1990 Wrangler (2.5L With Carburetor), Accelerator Cable | 17716.02 |
| 1987-1990 Wrangler (2.5L With EFI), Accelerator Cable | 17716.03 |
| 1987-1991 Grand Wagoneer (5.9L & 6.1L), Accelerator Cable | 17716.14 |
| 1987-1990 Cherokee (4.0L), Accelerator Cable | 17716.09 |
| 1991-1995 Cherokee (2.5L & 4.0L), Accelerator Cable | 17716.15 |

E. Accelerator Pedal Seal

Part#

| | |
|--|----------|
| 1941-1945 MB, 1941-1945 GPW, 1945-1949 CJ2A, 1948-1953 CJ3A, 1950-1952 M38, Accelerator Pedal | 17733.01 |
| 1941-1945 MB, 1941-1945 GPW, 1945-1949 CJ2A, 1948-1953 CJ3A, 1950-1952 M38, 1952-1971 M38A1, 1953-1967 CJ3B, 1955-1971 CJ5, 1955-1971 CJ6, Accelerator Pedal Dust Boot | 17734.01 |
| 1952-1971 M38A1, 1953-1967 CJ3B, 1955-1971 CJ5, 1955-1971 CJ6, Accelerator Pedal | 17733.02 |
| 1976-1983 CJ5, 1976-1986 CJ7, 1981-1986 CJ8, 1987-2006 Wrangler, 1984-2001 Cherokee, 1993-2004 Grand Cherokee, Accelerator Pedal NEW | 16753.05 |

F. Throttle Cables

Part#

| | |
|---|----------|
| 1941-1945 MB, 1941-1945 GPW, 1945-1949 CJ2A, 1948-1953 CJ3A, 1950-1952 M38, 1952-1971 M38A1, 1953-1967 CJ3B, 1955-1966 CJ5, 1955-1966 CJ6, Throttle Cable, With Olive Drab Knob | 17735.02 |
| 1941-1945 MB, 1941-1945 GPW, 1945-1949 CJ2A, 1948-1953 CJ3A, 1950-1952 M38, 1952-1971 M38A1, 1953-1967 CJ3B, 1955-1966 CJ5, 1955-1966 CJ6, Throttle Cable, With Black Knob | 17735.01 |

G. Choke Cables

Part#

| | |
|--|----------|
| 1941-1945 MB, 1941-1945 GPW, 1945-1949 CJ2A, 1948-1953 CJ3A, 1950-1952 M38, 1952-1971 M38A1, 1953-1967 CJ3B, 1955-1971 CJ5, 1955-1971 CJ6, Choke Cable, With Olive Drab Knob | 17736.02 |
| 1941-1945 MB, 1941-1945 GPW, 1945-1949 CJ2A, 1948-1953 CJ3A, 1950-1952 M38, 1952-1971 M38A1, 1953-1967 CJ3B, 1955-1971 CJ5, 1955-1971 CJ6, Choke Cable, With Black Knob | 17736.01 |

H. Air Cleaner Assemblies

Part#

| | |
|--|----------|
| 1941-1945 MB, 1941-1945 GPW, 1945-1949 CJ2A, 1948-1953 CJ3A, 1950-1952 M38, Air Cleaner Assembly (134 CI L-Head) | 17737.09 |
| 1941-1945 MB, 1941-1945 GPW, 1945-1949 CJ2A, 1948-1953 CJ3A, 1950-1952 M38, Air Cleaner Assembly Kit (134 CI L-Head), Includes Firewall Brackets | 17737.13 |

| I. Air Cleaner Brackets | Part# |
|--|----------|
| 1941-1945 MB, 1941-1945 GPW, 1945-1949 CJ2A, 1948-1953 CJ3A, 1950-1952 M38, Air Cleaner to Firewall Bracket (134 CI L-Head), Left | 17737.12 |
| 1941-1945 MB, 1941-1945 GPW, 1945-1949 CJ2A, 1948-1953 CJ3A, 1950-1952 M38, Air Cleaner to Firewall Bracket (134 CI L-Head), Right | 17737.11 |

| J. Air Cleaner Horns | Part# |
|--|----------|
| 1941-1945 MB, 1941-1945 GPW, 1945-1949 CJ2A, 1948-1953 CJ3A, 1950-1952 M38, Air Cleaner Horn (134 CI L-Head) | 12021.58 |
| 1952-1971 M38A1, 1953-1967 CJ3B, 1955-1971 CJ5, 1955-1971 CJ6, Air Cleaner Horn, (134 CI With F-Head) | 12025.29 |

| K. Air Cleaner Hoses | Part# |
|---|----------|
| 1941-1945 MB, 1941-1945 GPW, 1945-1949 CJ2A, 1948-1953 CJ3A, 1950-1952 M38, Air Horn to Crossover Tube Hose (134 CI L-Head) * | 17737.01 |
| 1941-1945 MB, 1941-1945 GPW, 1945-1949 CJ2A, 1948-1953 CJ3A, 1950-1952 M38, Air Horn to Carburetor Hose (134 CI L-Head) * | 17737.02 |
| 1941-1945 MB, 1941-1945 GPW, Crossover Tube (134 CI L-Head), Includes Bracket | 12021.59 |
| 1945-1949 CJ2A, 1948-1953 CJ3A, 1950-1952 M38, Crossover Tube (134 CI L-Head), Includes Bracket * | 12025.30 |
| 1953-1967 CJ3B, 1955-1971 CJ5, 1955-1971 CJ6, Air Cleaner Hose, (134 CI With F-Head) | 17737.06 |

| L. Air Cleaner Wing Nuts | Part# |
|--|----------|
| 1941-1945 MB, 1941-1945 GPW, 1945-1949 CJ2A, 1948-1953 CJ3A, 1950-1952 M38, Air Cleaner Wing Nut (134 CI L-Head) | 17737.10 |

| M. Air Filters | Part# |
|--|----------|
| 1972-1979 Models (3.8L), 1972-1990 (4.2L), 1981-1983 (2.5L GM), 1983-1986 (2.5L AMC), Air Filter | 17719.01 |
| 1972-1981 Models (5.0L), 1972-1982 (5.9L), Air Filter | 17719.03 |
| 1987-1995 Wrangler (2.5L With EFI), 1991-1995 Wrangler (4.0L), Air Filter | 17719.02 |
| 1987-2000 Cherokee (2.5L), 1987-2001 Cherokee (4.0L), Air Filter | 17719.05 |
| 1993-1998 Grand Cherokee (4.0L, 5.2L, 5.9L), 1994-2004 Grand Cherokee (4.0L & 4.7L), Air Filter | 17719.06 |
| 1997-2002 Wrangler (2.5L), 1997-2006 Wrangler (4.0L), Air Filter | 17719.04 |
| 2002-2005 Liberty (2.4L), 2003-2006 Wrangler (2.4L), Air Filter | 17719.08 |
| 2002-2007 Liberty (3.7L), 2005-2006 Liberty (2.8L Diesel), 2005-2010 Grand Cherokee (3.7L, 4.7L & 5.7L), 2006-2010 Commander (3.7L, 4.7L & 5.7L), Air Filter | 17719.07 |
| 2007-2011 Wrangler (3.8L), Air Filter NEW | 17719.09 |
| 2008-2010 Liberty (2.8L Diesel & 3.7L), Air Filter NEW | 17719.10 |

| N. Fuel Filters | Part# |
|---|----------|
| 1955-1983 CJ5, 1955-1975 CJ6, 1976-1986 CJ7, 1981-1986 CJ8, Fuel Filter Kit (Inline), Includes: Filter, Clamp & Hoses + | 17718.01 |
| 1955-1983 CJ5, 1955-1975 CJ6, 1976-1986 CJ7, 1981-1986 CJ8, Fuel Filter Kit (Inline) | 17728.01 |
| 1972-1983 CJ5 (3.8L & 4.2L), 1972-1975 CJ6 (3.8L & 4.2L), 1976-1986 CJ7 (3.8L & 4.2L), 1981-1986 CJ8 (4.2L), 1987-1990 Wrangler (4.2L), 1972-1990 Cherokee / Grand Wagoneer (SJ) (4.2L), Fuel Filter Kit (Inline With Dual Outlet), Includes: Filter, Clamp & Hoses | 17718.02 |
| 1972-1983 CJ5 (3.8L & 4.2L), 1972-1975 CJ6 (3.8L & 4.2L), 1976-1986 CJ7 (3.8L & 4.2L), 1981-1986 CJ8 (4.2L), 1987-1990 Wrangler (4.2L), 1972-1990 Cherokee / Grand Wagoneer (SJ) (4.2L), Fuel Filter Kit (Inline With Dual Outlet) | 17728.02 |
| 1987-1995 Wrangler (2.5L), 1984-1995 Cherokee (2.5L, 2.8L & 4.0L), Fuel Filter | 17718.03 |
| 1993-1996 Grand Cherokee (4.0L & 5.2L), Fuel Filter | 17718.04 |
| 1997-2004 Wrangler (2.4L, 2.5L & 4.0L), 1996-2001 Cherokee (2.5L & 4.0L), Fuel Filter | 17718.05 |
| 1997-1998 Grand Cherokee (4.0L, 5.2L & 5.9L), Fuel Filter | 17718.05 |
| 1999-2004 Grand Cherokee (4.0L, & 4.7L), Fuel Filter, Mounted on Pressure Regulator | 17718.06 |
| 2005-2009 Grand Cherokee (3.0L Diesel), Fuel Filter NEW | 17718.07 |



| O. EGR Valves | Part# |
|---|----------|
| 1981-1983 CJ5, 1981-1986 CJ7, 1981-1986 CJ8, 1981-1986 Cherokee / Grand Wagoneer (SJ), EGR Valve (4.2L) | 17712.01 |
| 1987-1990 Wrangler (2.5L & 4.2L), 1980-1990 Cherokee (2.5L & 4.0L), EGR Valve | 17712.02 |
| 1993-1998 Grand Cherokee (4.0L, 5.2L & 5.9L), EGR Valve | 17712.03 |
| 2005-2007 Grand Cherokee (4.7L & 5.7L), EGR Valve NEW | 17712.04 |

| P. Idle Air Control Valves | Part# |
|--|----------|
| 1987-1990 Cherokee (4.0L), Idle Air Control | 17715.06 |
| 1991-1995 Wrangler (2.5L), 1991-1995 Cherokee (2.5L), Idle Air Control | 17715.01 |
| 1991-1995 Cherokee (4.0L), 1994-1995 Wrangler (4.0L), 1993-1997 Grand Cherokee (4.0L), Idle Air Control Valve | 17715.03 |
| 1993-1998 Grand Cherokee (5.2L), 1998 Grand Cherokee (5.9L), Idle Air Control Valve | 17715.04 |
| 1997-2002 Wrangler (2.5L), 1997-2004 Wrangler (4.0L), 1998-2000 Cherokee (2.5L), 1998-2001 Cherokee (4.0L), 1998-2004 Grand Cherokee (4.0L), Idle Air Control Valve NEW | 17715.02 |
| 2004-2005 Liberty (2.4L), 2005-2006 Wrangler (2.4L), Idle Air Control Valve NEW | 17715.07 |
| 2004-2006 Wrangler (4.0L), 2004-2007 Liberty (3.7L), Idle Air Control Valve NEW | 17715.08 |

| Q. PCV Valves | Part# |
|---|----------|
| 1966-1971 Models, PCV Valve (225 CI) | 17404.06 |
| 1972-1981 Models (5.0L), 1972-1982 (5.9L), PCV Valve | 17404.03 |
| 1980-1983 CJ5 (2.5L GM & 2.5L AMC), 1980-1986 CJ7 (2.5L GM & 2.5L AMC), 1981-1986 CJ8 (2.5L GM & 2.5L AMC), PCV Valve | 17404.01 |
| 1983 CJ5, 1983-1986 CJ7, 1983-1986 CJ8, PCV Valve (2.5L AMC) | 17404.02 |
| 1991-2001 Grand Cherokee (4.7L), PCV Valve | 17404.08 |
| 1993 Grand Cherokee (5.2L), PCV Valve | 17404.04 |
| 1994-1998 Grand Cherokee (2.5L), 1998 Grand Cherokee (5.9L), PCV Valve | 17404.05 |
| 2002-2003 Liberty (2.4L), 2003-2004 Wrangler (2.4L), PCV Valve | 17404.09 |
| 2002-2007 Liberty (3.7L), 2002-2004 Grand Cherokee (4.7L Diesel), 2005-2007 Grand Cherokee (3.7L), PCV Valve NEW | 17404.07 |
| 2005-2006 Wrangler (2.4L), 2004-2005 Liberty (2.4L), PCV Valve NEW | 17404.11 |
| 2005 Grand Cherokee (4.7L), 2005-2006 Grand Cherokee (5.7L), PCV Valve | 17404.12 |

All images are subject to be representative. More detailed information is available online.

* Fits M38 With Down Draft Carburetor + Except 3.8L & 4.2L

Fuel



OMIX-ADA, Inc.



[R] 17714.06



[V] 17709.12



[W] 17709.26



[S] 17711.02



[U] 17232.50



[T] 17732.03

R. Fuel Injectors

| | Part# |
|---|----------|
| 1987-1990 Cherokee (4.0L), Fuel Injector | 17714.03 |
| 1991-1995 Wrangler (2.5L), 1991-1995 Cherokee (2.5L), Fuel Injector | 17714.01 |
| 1991-1993 Cherokee (4.0L), Fuel Injector | 17714.04 |
| 1993-1995 Grand Cherokee (5.2L), Fuel Injector | 17714.06 |
| 1996-2002 Wrangler (2.5L), 1996-1998 Wrangler (4.0L), 1996-2000 Cherokee (2.5L), 1996-1998 Cherokee (4.0L), 1996-1998 Grand Cherokee (4.0L & 5.2L), Fuel Injector | 17714.02 |
| 1999-2001 Cherokee (4.0L), 1999-2004 Grand Cherokee (4.0L) Fuel Injector | 17714.07 |
| 1999-2000 Grand Cherokee (4.7L), Fuel Injector | 17714.08 |
| 2001-2004 Grand Cherokee (4.7L), Fuel Injector | 17714.09 |
| 2002-2003 Liberty (2.4L), 2003-2004 Wrangler (2.4L), Fuel Injector | 17714.11 |
| 2002-2003 Liberty (3.7L), Fuel Injector | 17714.10 |

S. Fuel Pressure Regulators

| | Part# |
|---|----------|
| 1987-1990 Cherokee (4.0L), Fuel Pressure Regulator | 17711.02 |
| 1991-1995 Wrangler (2.5L & 4.0L), 1991-1996 Cherokee (2.5L & 4.0L), 1993-1996 Grand Cherokee (4.0L 5.2L), Fuel Pressure Regulator | 17711.01 |

T. Fuel Line Sets

| | Part# |
|---|----------|
| 1941-1944 MB, 1941-1944 Ford GPW, Fuel Line Set | 17732.01 |
| 1945 MB, 1945 Ford GPW, Fuel Line Set | 17732.02 |
| 1945-1949 CJ2A, Fuel Line Set | 17732.06 |
| 1950-1952 M38, Fuel Line Set | 17732.03 |
| 1952-1971 M38A1, Fuel Line Set | 17732.04 |
| 1955-1966 CJ5 (134 CI), Fuel Line Set | 17732.05 |

U. Fuel Lines

| | Part# |
|---|----------|
| 1941-1945 MB, 1941-1945 Ford GPW, 1945-1949 CJ2A, 1948-1953 CJ3A, 1953-1967 CJ3B, 1955-1969 CJ5, 1955-1969 CJ6, Fuel Hose (7'), To Fuel Pump NEW | 17232.50 |
| 1976-1979 CJ5 (3.8L), 1976-1983 CJ5 (4.2L), Fuel Line, Pump to Carburetor | 17732.22 |
| 1976-1979 CJ5 (3.8L), 1976-1983 CJ5 (4.2L), 1976-1981 CJ5 (5.0L), Fuel Line, Return Line | 17732.14 |
| 1976-1979 CJ5 (3.8L), 1976-1983 CJ5 (4.2L), 1976-1981 CJ5 (5.0L), Fuel Line, Vapor Line | 17732.17 |
| 1976-1979 CJ7 (3.8L), 1976-1983 CJ7 (4.2L), Fuel Line, Return Line | 17732.13 |
| 1976-1979 CJ7 (3.8L), 1976-1981 CJ7 (4.2L), Fuel Line, Vapor Line | 17732.19 |
| 1976-1979 CJ7 (3.8L), 1976-1981 CJ7 (4.2L), Fuel Line, Tank to Pump | 17732.08 |
| 1976-1981 CJ7 (5.0L), Fuel Line, Pump to Carburetor | 17732.26 |
| 1976-1981 CJ5 (5.0L), Fuel Line, Tank to Pump | 17732.12 |
| 1976-1981 CJ7 (5.0L), Fuel Line, Tank to Pump | 17732.11 |
| 1976-1981 CJ7 (5.0L), Fuel Line, Vapor Line | 17732.16 |
| 1982-1986 CJ7 (4.2L), Fuel Line, Return Line | 17732.23 |
| 1982-1986 CJ7 (4.2L), Fuel Line, Tank to Pump | 17732.10 |
| 1982-1986 CJ7 (4.2L), Fuel Line, Vapor Return | 17732.18 |
| Universal Fuel Line, 25' Coil, 13/16" X .028", With 16 Fittings | 16737.80 |
| Universal Fuel Line, 25' Coil, 1/4" X .028", With 14 Fittings | 16737.81 |
| Universal Fuel Line, 25' Coil, 5/16" X .028", With 10 Fittings | 16737.82 |
| Universal Fuel Line, 25' Coil, 3/8" X .028", With 6 Fittings | 16737.83 |

V. Fuel Pump

| | Part# |
|---|----------|
| 1941-1945 MB, 1941-1945 Ford GPW, 1945-1949 CJ2A, 1948-1953 CJ3A, 1953-1967 CJ3B, 1950-1952 M38, 1952-1971 M38A1, 1955-1966 CJ5, 1955-1966 CJ6, 1946-1964 Truck, 1946-1964 Station Wagon, 1948-1951 Jeepster, Fuel Pump (134 CI), Without Vacuum Operated Wipers, Single Action With Glass Fuel Bowl | 17709.01 |
| 1941-1945 MB, 1941-1945 Ford GPW, 1945-1949 CJ2A, 1948-1953 CJ3A, 1953-1967 CJ3B, 1950-1952 M38, 1952-1971 M38A1, 1955-1966 CJ5, 1955-1966 CJ6, 1946-1964 Truck, 1946-1964 Station Wagon, 1948-1951 Jeepster, Fuel Pump (134 CI), Without Vacuum Operated Wipers, Single Action Without Glass Fuel Bowl | 17709.02 |
| 1941-1945 MB, 1941-1945 Ford GPW, 1945-1949 CJ2A, 1948-1953 CJ3A, 1953-1967 CJ3B, 1950-1952 M38, 1952-1971 M38A1, 1955-1966 CJ5, 1955-1966 CJ6, 1946-1964 Truck, 1946-1964 Station Wagon, 1948-1951 Jeepster, Fuel Pump (134 CI), With Vacuum Operated Wipers, Dual Action Without Glass Fuel Bowl | 17709.03 |
| 1948-1953 CJ3A, 1946-1949 Truck, 1946-1949 Station Wagon, 1948-1949 Jeepster, Fuel Pump (134 CI), With Vacuum Operated Wipers, Dual Action Without Glass Fuel Bowl | 17709.04 |
| 1954-1964 Truck, 1954-1964 Station Wagon, Fuel Pump (226 CI) | 17709.10 |
| 1954-1964 Truck, 1954-1964 Station Wagon, Fuel Pump (230 CI) | 17709.11 |
| 1966-1971 CJ5, 1966-1971 CJ6, 1966 Jeepster, Fuel Pump (225 CI) | 17709.17 |
| 1972-1973 CJ5 (3.8L & 4.2L), 1972-1973 CJ6 (3.8L & 4.2L), 1972-1973 Cherokee / Grand Wagoneer (SJ) (4.2L), Fuel Pump | 17709.12 |
| 1972-1975 CJ5 (5.0L), 1972-1975 CJ6 (5.0L), Fuel Pump | 17709.14 |
| 1974-1979 CJ5 (3.8L), 1974-1983 CJ5 (4.2L), 1974-1975 CJ6 (3.8L & 4.2L), 1976-1979 CJ7 (3.8L), 1976-1986 CJ7 (4.2L), 1986 CJ8 (4.2L), Fuel Pump | 17709.06 |
| 1976-1981 CJ5 (5.0L), 1976-1981 CJ7 (5.0L), 1981 CJ8 (5.0L), Fuel Pump | 17709.15 |
| 1983 CJ5 (2.5L AMC), 1983-1986 CJ7 (2.5L AMC), 1983-1986 CJ8 (2.5L AMC), 1987-1988 Wrangler (2.5L), Fuel Pump | 17709.06 |
| 1987-1990 Wrangler (2.5L With Carb), 1986-1990 Cherokee (2.5L With Carb), Electric Fuel Pump | 17709.07 |
| 1987-1990 Wrangler (2.5L With EFI), 1986-1990 Cherokee (2.5L With EFI), Electric Fuel Pump | 17709.08 |
| 1987-1990 Wrangler (4.2L), Fuel Pump, With Front Inlet Fitting | 17709.13 |
| 1987-1990 Wrangler (4.2L), Fuel Pump, With Rear Inlet Fitting | 17709.06 |
| 1987-1993 Cherokee (4.0L), 1991-1993 Wrangler (4.0L), Electric Fuel Pump | 17709.09 |

W. Fuel Pump Module

| | Part# |
|---|----------|
| 1991-1995 Wrangler, Fuel Pump Module (2.5L & 4.0L), With 20 Gallon Tank | 17724.16 |
| 1993-1994 Grand Cherokee, Fuel Pump Module (4.0L & 5.2L) | 17709.22 |
| 1999-2000 Grand Cherokee, Fuel Pump Module (4.0L & 4.7L) | 17709.24 |
| 1995 Grand Cherokee, Fuel Pump Module (4.0L & 5.2L) | 17709.21 |
| 1996 Grand Cherokee, Fuel Pump Module (4.0L & 5.2L) | 17709.20 |
| 2003-2006 Wrangler, Fuel Pump Module (2.4L & 4.0L), With 19 Gallon Tank | 17709.26 |
| 2003-2004 Grand Cherokee, Fuel Pump Module (4.0L & 4.7L) | 17709.23 |
| 2005-2006 Grand Cherokee, Fuel Pump Module (3.7L, 4.7L & 5.7L) | 17709.25 |
| 1991-1993 Cherokee, Fuel Pump Module (2.5L) NEW | 17709.27 |
| 1997-1998 Grand Cherokee, Fuel Pump Module (4.0L, 5.2L & 5.9L) NEW | 17709.28 |
| 1997-2001 Cherokee, Fuel Pump Module (2.5L & 4.0L) NEW | 17709.29 |
| 1997-1999 Wrangler, Fuel Pump Module (2.5 & 4.0L), w 15 Gallon Tank NEW | 17709.30 |
| 1996 Cherokee, Fuel Pump Module (2.5L) | 17709.31 |
| 1997-2002 Wrangler, Fuel Pump Module (2.5L & 4.0L), w 19 Gallon Tank NEW | 17709.32 |
| 1987-1990 Cherokee (4.0L), Fuel Pump Module NEW | 17709.33 |

WARNING
Restoration or replacement fuel tanks are direct replacements of original components and are not designed or warranted as meeting current safety standards (including FMVSS).

| Y. Fuel Sending Units | Part# |
|--|----------|
| 1945-1949 CJ2A, 1948-1953 CJ3A, 1953 CJ3B, Fuel Sending Unit * | 17724.01 |
| 1954-1967 CJ3B, Fuel Sending Unit + | 17724.02 |
| 1946-1964 Station Wagon, 1948-1951 Jeepster, Fuel Sending Unit [226 CI] | 17724.05 |
| 1946-1964 Truck, Fuel Sending Unit [226 CI] | 17724.06 |
| 1955-1966 CJ5, 1955-1966 CJ6, Fuel Sending Unit [134 CI] | 17724.02 |
| 1963-1979 J10 / J20 Truck, Fuel Sending Unit | 17724.21 |
| 1966-1971 CJ5, 1967-1971 CJ6, Fuel Sending Unit [225 CI] | 17724.04 |
| 1967-1971 CJ5, 1967-1971 CJ6, Fuel Sending Unit [134 CI] | 17724.03 |
| 1970-1983 CJ5, 1970-1975 CJ6, 1976-1986 CJ7, 1981-1986 CJ8, Fuel Tank Sending Unit, For 15 Gallon Steel or Polyethylene Tank | 17724.07 |
| 1970-1983 CJ5, 1970-1975 CJ6, 1976-1986 CJ7, 1981-1986 CJ8, Fuel Tank Sending Unit, For 20 Gallon Polyethylene Tank | 17724.11 |
| 1970-1983 CJ5, 1970-1975 CJ6, 1976-1986 CJ7, 1981-1986 CJ8, Fuel Tank Sending Unit Kit, For 20 Gallon Polyethylene Tank, Includes: Sender, Lock Ring, Gasket, | 17724.13 |
| 1970-1983 CJ5, 1970-1975 CJ6, 1976-1986 CJ7, 1981-1986 CJ8, Fuel Tank Sending Unit Kit, For 15 Gallon Steel or Polyethylene Tank, Includes: Sender, Lock Ring & Gasket | 17724.09 |
| 1970-1979 Cherokee / Grand Wagoneer [SJ], Fuel Sending Unit | 17724.18 |
| 1972-1984 DJ Postal Jeep, Fuel Sending Unit, For 15 Gallon Tank | 17724.17 |
| 1981-1985 Grand Wagoneer [SJ], Fuel Sending Unit | 17724.20 |
| 1982-1983 CJ5, 1982-1986 CJ7, 1982-1986 CJ8, Fuel Tank Sending Unit, For 20 Gallon Steel Tank | 17724.12 |
| 1987-1995 Wrangler [2.5L & 4.2L], Fuel Tank Sending Unit, For 20 Gallon Polyethylene Tank | 17724.16 |
| 1945-1949 CJ2A, 1948-1953 CJ3A, 1953 CJ3B, Fuel Sending Unit Gasket * | 17725.01 |
| 1954-1967 CJ3B, Fuel Sending Unit Gasket | 17725.02 |
| 1955-1983 CJ5, 1955-1975 CJ6, 1976-1986 CJ7, 1981-1986 CJ8, Fuel Tank Sending Unit Float, Plastic | 17729.01 |
| 1970-1983 CJ5, 1970-1975 CJ6, 1976-1986 CJ7, 1981-1986 CJ8, Fuel Tank Sending Unit O-Ring Gasket | 17730.01 |
| 1970-1983 CJ5, 1970-1975 CJ6, 1976-1986 CJ7, 1981-1986 CJ8, Fuel Tank Sending Unit Lock Ring, For 15 Gallon Tank | 17727.01 |
| 1970-1983 CJ5, 1970-1975 CJ6, 1976-1986 CJ7, 1981-1986 CJ8, Fuel Tank Sending Unit Lock Ring, For 20 Gallon Tank | 17727.02 |
| 1970-1979 Cherokee / Grand Wagoneer [SJ], Fuel Sending Unit Pickup Tube | 17724.22 |
| 1987-1990 Wrangler [2.5L & 4.2L], Fuel Tank Sending Unit Gasket | 17730.02 |
| 1987-1990 Wrangler, Fuel Tank Sending Unit Lock Ring | 17727.03 |

| Z. Fuel Pump Filters | Part# |
|--|----------|
| 1991-1995 Wrangler, 1994-1996 Cherokee, Fuel Pump Filter [2.5L & 4.0L] | 17709.18 |
| 1997-2002 Wrangler [2.5L & 4.0L], 1997-2001 Cherokee [2.5L & 4.0L], 1997-1998 Grand Cherokee [4.0L, 5.2L & 5.9L], Fuel Pump Filter | 17709.19 |

| Z-1. Steel Gas Tanks | Part# |
|---|----------|
| 1941-1942 MB, 1941-1945 Ford GPW, Gas Tank, Small Spout Design | 17720.01 |
| 1942-1945 MB, 1941-1945 Ford GPW, Gas Tank, Large Spout Design | 17720.02 |
| 1945-1949 CJ2A, 1948-1953 CJ3A, 1953 CJ3B, Gas Tank * | 17720.04 |
| 1950-1952 M38, Gas Tank | 17720.03 |
| 1952-1971 M38A1, Gas Tank | 17720.07 |
| 1954-1967 CJ3B, Gas Tank + | 17720.05 |
| 1955-1969 CJ5, 1955-1969 CJ6, Gas Tank [134 CI] | 17720.06 |
| 1970-1975 CJ5, 1970-1975 CJ6, Gas Tank [2.25" Inlet Diameter, With 6.5" Filler Neck] + | 17720.08 |
| 1976-1977 CJ5, 1976-1977 CJ7, Gas Tank [2.25" Inlet Diameter, With 1.25" Filler Neck], 15 Gallon | 17720.09 |
| 1978-1983 CJ5, 1978-1986 CJ7, 1981-1986 CJ8, Gas Tank [1" Inlet Diameter], 15 Gallon | 17720.10 |
| 1984-1986 Cherokee [2.5L With Carb & 2.8L], 1986-1994 Cherokee [2.1L Diesel], 1995-1996 Cherokee [2.5L Diesel], Gas Tank, 13.5 or 20.2 Gallon 0 | 17720.14 |
| 1986-1996 Cherokee [2.5L with EFI], 1987-1996 Cherokee [4.0L], Gas Tank, 13.5 or 20.2 Gallon 0 | 17720.15 |
| 1987-1990 Wrangler [2.5L], Gas Tank | 17720.12 |
| 1987-1990 Wrangler [4.2L], Gas Tank | 17720.13 |



| Z-2. Polyethylene Gas Tanks | Part# |
|---|----------|
| 1945-1949 CJ2A, 1948-1953 CJ3A, 1953 CJ3B, Polyethylene Gas Tank UPGRADE * | 17722.01 |
| 1945-1949 CJ2A, 1948-1953 CJ3A, 1953 CJ3B, Polyethylene Gas Tank, Auxiliary, Mounts Under Passenger Seat UPGRADE * | 17722.02 |
| 1946-1964 Truck, Polyethylene Gas Tank Kit, 17 Gallon, Includes Gas Tanking & Mounting Kit UPGRADE | 17722.14 |
| 1946-1964 Station Wagon, Polyethylene Gas Tank Kit, 18 Gallon, Includes Gas Tanking & Mounting Kit UPGRADE | 17722.21 |
| 1954-1967 CJ3B, Polyethylene Gas Tank UPGRADE | 17722.03 |
| 1954-1967 CJ3B, Polyethylene Gas Tank, Auxiliary, Mounts Under Passenger Seat UPGRADE + | 17722.04 |
| 1955-1969 CJ5, 1955-1969 CJ6, Polyethylene Gas Tank [134 CI] UPGRADE | 17722.05 |
| 1955-1969 CJ5, 1955-1969 CJ6, Polyethylene Gas Tank [134 CI], Auxiliary, Mounts Under Passenger Seat UPGRADE | 17722.06 |
| 1962-1977 J10 / J20 Truck, Polyethylene Gas Tank, 18 Gallon ~ | 17722.15 |
| 1967-1971 CJ6, Polyethylene Gas Tank [225 CI] UPGRADE | 17722.07 |
| 1967-1971 CJ6, Polyethylene Gas Tank [225 CI], Auxiliary, Mounts Under Passenger Seat UPGRADE | 17722.08 |
| 1970-1975 CJ5, 1970-1975 CJ6, Polyethylene Gas Tank [2.25" Inlet Diameter, With 6.5" Filler Neck] UPGRADE | 17722.09 |
| 1970-1977 Cherokee / Wagoneer [SJ], Polyethylene Gas Tank Kit, 21 Gallon, Includes Tank & Mounting Kit UPGRADE | 17722.18 |
| 1976-1977 CJ5, 1976-1977 CJ7, Polyethylene Gas Tank [2.25" Inlet Diameter, With 1.25" Filler Neck], 21 Gallon UPGRADE | 17722.10 |
| 1978-1983 CJ5, 1978-1986 CJ7, 1981-1986 CJ8, Polyethylene Gas Tank [1" Inlet Diameter], 15 Gallon UPGRADE | 17722.11 |
| 1978-1983 CJ5, 1978-1986 CJ7, 1981-1986 CJ8, Polyethylene Gas Tank [1" Inlet Diameter], 20 Gallon UPGRADE | 17722.12 |
| 1978-1983 CJ5, 1978-1986 CJ7, 1981-1986 CJ8, Polyethylene Gas Tank Kit [1" Inlet Diameter], 20 Gallon, Includes Gas Tanking & Mounting Kit UPGRADE | 17722.22 |
| 1978-1979 Cherokee / Wagoneer [SJ], Polyethylene Gas Tank Kit, 21 Gallon, Includes Tank & Mounting Kit UPGRADE | 17722.19 |
| 1978-1979 J10 / J20 Truck, Polyethylene Gas Tank [With Side Filler Pipe], 18 Gallon UPGRADE ~ | 17722.16 |
| 1978-1979 J10 / J20 Truck, Polyethylene Gas Tank [With Front Filler Pipe], 18 Gallon UPGRADE ~ | 17722.20 |
| 1987-1990 Wrangler [2.5L & 4.2L], Polyethylene Gas Tank, 15 Gallon UPGRADE | 17722.13 |
| 1987-1995 Wrangler [2.5L & 4.2L], Polyethylene Gas Tank, 20 Gallon UPGRADE-NEW | 17722.23 |

| Z-3. OE Style Gas Tank Skid Plates & Wells | Part# |
|--|----------|
| 1941-1942 MB and Ford GPW, Gas Tank Well [Cover] | 12021.21 |
| 1943-1945 MB and Ford GPW, Gas Tank Well [Cover] | 12021.22 |
| 1941-1945 MB, 1941-1945 Ford GPW, 1945-1949 CJ2A, 1948-1953 CJ3A, 1953-1967 CJ3B, 1952-1967 M38A1, 1955-1969 CJ5, 1955-1969 CJ6, Gas Tank Felt Kit [8 Piece Kit] | 12021.87 |
| 1976-1983 CJ5, 1976-1986 CJ7, 1981-1986 CJ8, 1987-1990 Wrangler, Gas Tank Skid Plate [For 15 Gallon Tank] | 17721.01 |
| 1987-1995 Wrangler, Gas Tank Skid Plate [For 20 Gallon Tank] | 17721.02 |

All images are subject to be representative. More detailed information is available online.
 * CJ3B Up To Serial 39838 + CJ3B After Serial 39838 * Except 225 CI 0 Fuel Filler Pipe Determines Fill Level ~ Requires Mounting Kit PN: 17723.01



| Z-4. Gas Tank Straps | Part# |
|---|----------|
| 1945-1949 CJ2A, 1948-1953 CJ3A, 1953-1967 CJ3B, 1952-1971 M38A1, Gas Tank Strap Kit, Center | 12025.24 |
| 1978-1983 CJ5, 1978-1986 CJ7, 1981-1986 CJ8, Gas Tank Strap, Left, For Polyethylene or Steel 15 Gallon Tank | 17739.04 |
| 1978-1983 CJ5, 1978-1986 CJ7, 1981-1986 CJ8, Gas Tank Strap, Right, For Polyethylene or Steel 15 Gallon Tank | 17739.05 |
| 1978-1983 CJ5, 1978-1986 CJ7, 1981-1986 CJ8, Gas Tank Strap, Center, For Polyethylene or Steel 15 Gallon Tank | 17739.01 |
| 1978-1983 CJ5, 1978-1986 CJ7, 1981-1986 CJ8, Gas Tank Strap, Center, For Polyethylene 20 Gallon Tank | 17739.03 |
| Polyethylene Gas Tank Mounting Kit [For 17722.15, 17722.16 & 17722.20] | 17723.01 |
| 1987-1990 Wrangler (2.5L & 4.2L), Gas Tank Strap, Left | 17739.04 |
| 1987-1990 Wrangler (2.5L & 4.2L), Gas Tank Strap, Right | 17739.05 |
| 1987-1990 Wrangler (2.5L & 4.2L), Gas Tank Strap, Center | 17739.02 |
| 1997-2006 Wrangler (2.4L, 2.5L & 4.0L), Gas Tank Strap, Center | 17739.06 |

| Z-5. Fuel Vent Hoses | Part# |
|--|----------|
| 1945-1949 CJ2A, 1948-1953 CJ3A, 1953-1967 CJ3B, 1955-1969 CJ5, 1955-1969 CJ6, Fuel Filler Neck Grommet | 12025.23 |
| 1978-1983 CJ5, 1978-1986 CJ7, Fuel Vent Hose, 15 Gallon Tank | 17741.01 |
| 1978-1983 CJ5, 1978-1986 CJ7, 1981 CJ8, Fuel Filler Neck [1" Inlet Diameter], 15 Gallon | 17743.01 |
| 1991-1995 Wrangler, Fuel Filler Neck | 17743.03 |
| 1982-1983 CJ5, 1982-1986 CJ7, Fuel Vent Hose, 20 Gallon Tank | 17741.02 |
| 1997-2002 Wrangler, Fuel Filler Neck | 17742.02 |
| 1981-1986 CJ8, Fuel Vent Hose, 15 Gallon Tank | 17741.03 |
| 1987-1990 Wrangler, Fuel Vent Hose | 17741.04 |
| 1991-1995 Wrangler, Fuel Vent Hose, For 20 Gallon Tank | 17741.05 |
| 1997-2002 Wrangler, Fuel Vent Hose | 17741.06 |

| Z-6. Fuel Filler Neck Protectors | Part# |
|--|----------|
| 1945-1949 CJ2A, 1948-1953 CJ3A, 1953-1967 CJ3B, 1955-1969 CJ5, 1955-1969 CJ6, Fuel Filler Neck Protector | 12025.25 |
| 1950-1952 M38, 1952-1971 M38A1, Fuel Filler Neck Protector | 12023.11 |
| 1978-1983 CJ5, 1978-1986 CJ7, 1981-1986 CJ8, Fuel Filler Neck Protector, Plastic | 17742.01 |
| 1978-1983 CJ5, 1978-1986 CJ7, 1981-1986 CJ8, Fuel Filler Neck Protector, Stainless Steel | 11135.01 |
| 1987-1995 Wrangler, Fuel Filler Neck Protector, Plastic | 17742.01 |
| 1987-1995 Wrangler, Fuel Filler Neck Protector, Stainless Steel | 11135.01 |
| 1997-2006 Wrangler, Fuel Filler Neck Protector, Stainless Steel | 11135.02 |

| Z-7. Fuel Filler Hoses | Part# |
|--|----------|
| 1970-1975 CJ5, 1970-1975 CJ6, Fuel Filler Hose | 17740.01 |
| 1976-1977 CJ5, 1976-1977 CJ7, Fuel Filler Hose [2.25" Inlet Diameter, With 1.25" Filler Neck] | 17740.02 |
| 1978-1983 CJ5, 1978-1986 CJ7, Fuel Filler Hose [1" Inlet Diameter], 15 Gallon | 17740.03 |
| 1981-1986 CJ8, Fuel Filler Hose [1" Inlet Diameter] | 17740.05 |
| 1982-1983 CJ5, 1982-1986 CJ7, 1982-1986 CJ8, Fuel Filler Hose [1.25" Inlet Diameter], 20 Gallon Tank | 17740.04 |
| 1987-1990 Wrangler, Fuel Filler Hose | 17740.06 |
| 1991-1995 Wrangler, Fuel Filler Hose, For 20 Gallon Tank | 17740.07 |
| 1997-2002 Wrangler, Fuel Filler Hose | 17740.08 |

| Z-8. Hose Clamps | Part# |
|-----------------------------------|----------|
| Universal Hose Clamp, 1" to 1.25" | 17744.01 |
| Universal Hose Clamp, 1" to 1.5" | 17744.02 |
| Universal Hose Clamp, 3" | 17744.03 |

| Z-9. Gas Caps | Part# |
|---|----------|
| 1942-1944 MB, 1941-1944 Ford GPW, Gas Cap, Metal, Olive Drab | 17726.01 |
| 1945-1949 CJ2A, 1948-1953 CJ3A, 1953-1967 CJ3B, 1955-1969 CJ5, 1955-1969 CJ6, Zinc, Non-Vented | 17726.02 |
| 1945-1949 CJ2A, 1948-1953 CJ3A, 1953-1967 CJ3B, 1955-1969 CJ5, 1955-1969 CJ6, Black, Non-Vented | 17726.03 |
| 1946-1964 Truck, 1946-1964 Station Wagon, Gas Cap, Zinc, Non-Locking | 17726.11 |
| 1963-1971 J10 / J20 Truck, 1963-1971 Wagoneer, Gas Cap, Zinc, Non-Locking | 17726.13 |
| 1971-1976 CJ5, 1971-1976 CJ6, Gas Cap, Zinc, Non-Vented, Non-Locking | 17726.04 |
| 1971-1976 CJ5, 1971-1976 CJ6, Gas Cap, Black, Non-Vented, Locking | 17726.05 |
| 1978-1986 CJ5, 1978-1986 CJ7, 1981-1986 CJ8, 1987-1990 Wrangler, Gas Cap, Zinc, Non-Vented, Non-Locking | 17726.07 |
| 1978-1986 CJ5, 1978-1986 CJ7, 1981-1986 CJ8, 1987-1990 Wrangler, Gas Cap, Black, Non-Vented, Locking | 17726.06 |
| 1991-1995 Wrangler, Gas Cap, Black, Non-Locking | 17726.09 |
| 1991-1995 Wrangler, Gas Cap, Black, Locking | 17726.08 |
| 1997-2000 Wrangler, Gas Cap, 1984-1999 Cherokee, 1993-2000 Cherokee, Black, Non-Locking | 17726.09 |
| 1997-2000 Wrangler, 1984-1999 Cherokee Gas Cap, 1993-2000 Cherokee, Black, Locking | 17726.08 |
| 2001-2006 Wrangler, 2000-2001 Cherokee, 2001-2004 Grand Cherokee, 2002-2005 Liberty, Gas Cap, Black, Non-Locking NEW | 17726.12 |
| 2001-2006 Wrangler, 2000-2001 Cherokee, 2001-2004 Grand Cherokee, 2002-2005 Liberty, Gas Cap, Black, Locking NEW | 17726.10 |



[A] 17908.01

[B] 17905.04

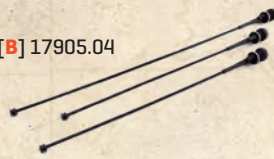

[C] 17907.01



[F] 17950.05

| A. Heater Seals | Part# |
|---|----------|
| 1978-1983 CJ5, 1978-1986 CJ7, 1981-1986 CJ8, 1987-1995 Wrangler, Heater Core Tube Seal | 17908.01 |
| 1978-1983 CJ5, 1978-1986 CJ7, 1981-1986 CJ8, 1987-1990 Wrangler, Heater Firewall Motor Seal | 17908.02 |
| 1991-1995 Wrangler, Heater Firewall Motor Seal | 17908.03 |

| B. Control Cables | Part# |
|--|----------|
| 1978-1983 CJ5, 1978-1986 CJ7, 1981-1986 CJ8, Heater Cable Kit (3 Pieces) | 17905.04 |
| 1978-1983 CJ5, 1978-1986 CJ7, 1981-1986 CJ8, Heater Cable, Defroster (21") | 17905.01 |
| 1978-1983 CJ5, 1978-1986 CJ7, 1981-1986 CJ8, Heater Cable, Temp (21.5") | 17905.02 |
| 1978-1983 CJ5, 1978-1986 CJ7, 1981-1986 CJ8, Heater Cable, Air (28") | 17905.03 |
| 1987-1995 Wrangler, Air Vent Cable, Blue NEW | 17905.05 |
| 1987-1995 Wrangler, Heater Defroster Cable, Red NEW | 17905.06 |
| 1997-2001 Wrangler, AC Plenum Door Lever, For Lower AC Panel | 17910.01 |
| 1997-2001 Wrangler, AC Plenum Door Lever, For Upper Defroster Door | 17910.02 |

| C. Vents & Defrosters | Part# |
|--|----------|
| 1972-1977 CJ5, 1972-1975 CJ6, 1976-1977 CJ7, 1966-1973 Commando, Fresh Air Box (With Brackets) | 17906.01 |
| 1978-1983 CJ5, 1978-1986 CJ7, 1981-1986 CJ8, Defroster Duct Hose NEW | 17907.02 |
| 1955-1977 CJ5, 1955-1975 CJ6, 1977 CJ7, Heater Defroster Duct | 17907.01 |
| 1978-1983 CJ5, 1978-1986 CJ7, 1981-1986 CJ8, Defroster Ducts (Pair) | 17907.03 |
| 1978-1983 CJ5, 1978-1986 CJ7, 1981-1986 CJ8, Defroster Deflector Vents (Pair) | 17907.04 |
| 1987-1995 Wrangler, Heater Floor Duct * | 17907.05 |

| D. Switches & Knobs | Part# |
|--|----------|
| 1968-1983 CJ5, 1968-1975 CJ6, 1976-1986 CJ7, 1981-1986 CJ8, Heater Switch Knob | 13318.05 |
| 1987-1995 Wrangler, Heater Control Panel, w/out A/C NEW | 17954.01 |
| 1999-2006 Wrangler, Climate Control Knob (3 Required) | 17903.20 |
| 1976-1977 CJ5, 1976-1977 CJ7, Heater Blower Switch | 17903.01 |
| 1978-1983 CJ5, 1978-1986 CJ7, 1981-1986 CJ8, Heater Blower Switch | 17903.02 |
| 1997-2002 Wrangler, Heater Blower Switch | 17903.04 |
| 1991-1996 Cherokee, 1993 Grand Cherokee, Heater Blower Switch | 17903.03 |

| E. AC Compressor | Part# |
|--|----------|
| 1984-1990 Cherokee (2.5L & 2.8L), 1987-1990 Grand Wagoner (SJ), AC Compressor NEW | 17953.01 |
| 1997-2002 Wrangler (2.5L), 1997-1999 Wrangler (4.0L), 1997-2000 Cherokee (2.5L), 1997-2001 Cherokee (4.0L), AC Compressor NEW | 17953.02 |
| 1999-2004 Grand Cherokee (4.0L), 2000-2006 Wrangler (4.0L), AC Compressor NEW | 17953.03 |
| 2003-2006 Wrangler (2.4L), AC Compressor NEW | 17953.04 |
| 1999-2004 Grand Cherokee (4.7L), AC Compressor NEW | 17953.05 |
| 2006-2009 Liberty (3.7L), AC Compressor NEW | 17953.06 |

| F. AC Condenser | Part# |
|--|----------|
| 1987-1990 Cherokee (With Expansion Valve), AC Condenser | 17950.01 |
| 1987-1995 Wrangler, AC Condenser | 17950.02 |
| 1997-2000 Wrangler, AC Condenser | 17950.03 |
| 1984-1986 Cherokee (2.5L & 2.8L), AC Condenser | 17950.04 |
| 1987-1996 Cherokee (4.0L), AC Condenser | 17950.05 |
| 1992-1997 Cherokee (4.0L With Serpentine Belt), AC Condenser | 17950.06 |
| 1997-2001 Cherokee (4.0L), AC Condenser (With Parallel Flow) | 17950.07 |
| 1993-1998 Grand Cherokee, AC Condenser | 17950.08 |
| 1999-2004 Grand Cherokee, AC Condenser | 17950.09 |



[B] 17910.01



[G] 17952.01



[E] 17953.01



[H] 17951.01



[D] 17903.20

| G. AC Evaporator | Part# |
|---|----------|
| 1987-1990 Cherokee (2.5L & 4.0L) AC Evaporator | 17952.01 |
| 1991-1993 Cherokee (2.5L & 4.0L) AC Evaporator | 17952.02 |
| 1994-1996 Cherokee (2.5L & 4.0L) AC Evaporator | 17952.03 |
| 1993 Grand Cherokee (4.0L & 5.2L) AC Evaporator | 17952.04 |

| H. Receiver Drier | Part# |
|---|----------|
| 1984-1986 Cherokee (2.1L Diesel, 2.5L & 2.8L), Receiver Drier | 17951.01 |
| 1987-1996 Cherokee (2.5L), Receiver Drier | 17951.02 |
| 1987-1990 Cherokee (4.0L), Receiver Drier | 17951.03 |
| 1991-1996 Cherokee (4.0L With Factory R12), Receiver Drier | 17951.04 |
| 1994-1996 Cherokee (4.0L With Factory R134A), Receiver Drier | 17951.05 |
| 1993-1994 Grand Cherokee (4.0L), Receiver Drier | 17951.06 |
| 1993-1995 Grand Cherokee (5.2L), Receiver Drier | 17951.07 |

| I. Heater Cores | Part# |
|---|----------|
| 1972-1977 CJ5, 1972-1975 CJ6, 1976-1977 CJ7, Heater Core (With 2 Speed Heater Blower Motor) | 17901.01 |
| 1978-1983 CJ5, 1978-1986 CJ7, 1981-1986 CJ8, Heater Core (With 3 Speed Heater Blower Motor) | 17901.02 |
| 1987-1995 Wrangler, Heater Core | 17901.03 |
| 1997-2001 Wrangler, Heater Core | 17901.04 |
| 2002-2006 Wrangler, Heater Core | 17901.05 |
| 1984-1996 Cherokee, Heater Core | 17901.08 |
| 1997-2001 Cherokee, Heater Core | 17901.04 |
| 1993-1998 Grand Cherokee, Heater Core | 17901.09 |
| 1999-2004 Grand Cherokee, Heater Core | 17901.10 |
| 2002-2007 Liberty, Heater Core | 17901.11 |
| 1972-1977 Cherokee / Grand Wagoner (SJ), Heater Core | 17901.07 |
| 1978-1983 Cherokee / Grand Wagoner (SJ), Heater Core | 17901.07 |

| J. Heater Blower Motor | Part# |
|--|----------|
| 1972-1977 CJ5, 1972-1975 CJ6, 1976-1977 CJ7, Heater Blower Motor (2-Speed) | 17904.01 |
| 1978-1983 CJ5, 1978-1986 CJ7, 1981-1986 CJ8, 1987-1990 Wrangler, Heater Blower Motor (3-Speed) * | 17904.02 |
| 1987-1995 Wrangler, Heater Box Assembly, Includes Heater Core, Heater Motor and Fan NEW | 17954.02 |
| 1991-1995 Wrangler, Heater Blower Motor | 17904.03 |
| 1988-1993 Cherokee, Heater Blower Motor | 17904.04 |
| 1993-1998 Grand Cherokee, Heater Blower Motor | 17904.05 |
| 2005-2010 Grand Cherokee, Heater Blower Motor NEW | 17904.06 |

| K. Heater Blower Resistor | Part# |
|--|----------|
| 1997-2001 Wrangler (All) 2002-2006 Wrangler (RHD With 4WD), 1993-1994 Grand Cherokee, 1997-2001 Cherokee, Heater Blower Resistor | 17909.03 |
| 1991-1996 Cherokee, Heater Blower Resistor | 17909.01 |
| 1993-1998 Grand Cherokee (Without AC), Heater Blower Resistor | 17909.02 |

* 1976-1986 CJ Can Convert To This Later Style

Steering

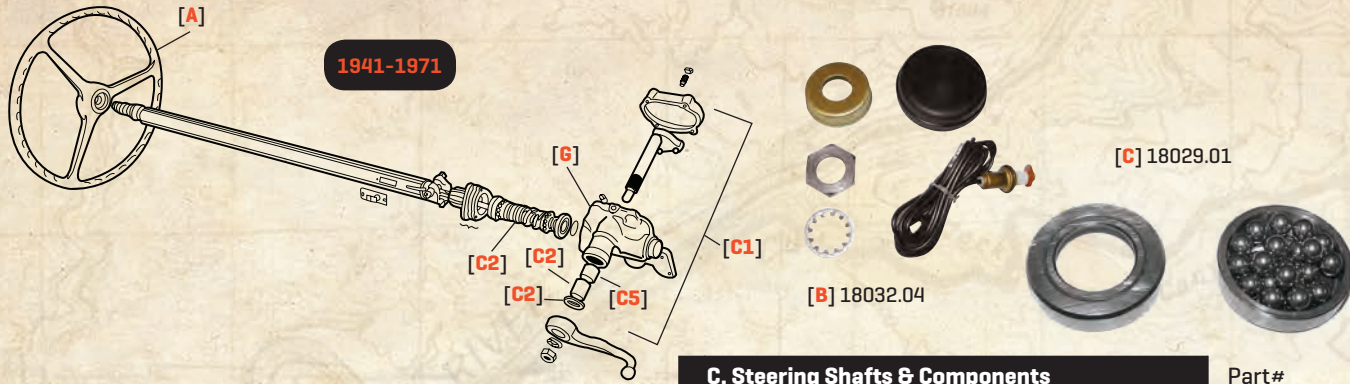

OMIX-ADA, Inc.

A. Steering Wheels Part#

| | |
|--|----------|
| 1941-1945 MB, 1941-1945 Ford GPW, Steering Wheel, Olive Drab With Metal Spokes | 18031.03 |
| 1945-1949 CJ2A, 1948-1953 CJ3A, 1950-1952 M38, 1953-1967 CJ3B, 1953-1971 M38A1, 1955-1966 CJ5, 1955-1966 CJ6, Steering Wheel, Black, For 1.25" Horn Button | 18031.01 |
| 1945-1949 CJ2A, 1948-1953 CJ3A, 1950-1952 M38, 1953-1967 CJ3B, 1953-1971 M38A1, 1955-1966 CJ5, 1955-1966 CJ6, Steering Wheel, Green, For 1.25" Horn Button | 18031.02 |
| 1960-1975 CJ5, 1960-1975 CJ6, Steering Wheel, Black, For 2-3/8" Horn Button | 18031.04 |
| 1976-1983 CJ5, 1976-1986 CJ7, 1981-1986 CJ8, 1987-1995 Wrangler, Steering Wheel, Metal 3-Spoke, Black Vinyl | 18031.05 |
| 1976-1983 CJ5, 1976-1986 CJ7, 1981-1986 CJ8, 1987-1995 Wrangler, Steering Wheel, Metal 3-Spoke, Black Leather | 18031.08 |
| 1976-1983 CJ5, 1976-1986 CJ7, 1981-1986 CJ8, 1987-1995 Wrangler, Steering Wheel Kit (With Horn Button), Metal 3-Spoke, Black Vinyl | 18031.07 |

B. Horn Buttons Part#

| | |
|---|----------|
| 1945-1949 CJ2A, 1948-1953 CJ3A, 1950-1952 M38, 1953-1967 CJ3B, 1953-1971 M38A1, 1955-1966 CJ5, 1955-1966 CJ6, Horn Button & Nut (1.25") | 18032.02 |
| 1941-1945 MB, 1941-1945 Ford GPW, Horn Button Wiring Kit | 18032.01 |
| 1941-1945 MB, 1941-1945 Ford GPW, 1945-1949 CJ2A, Horn Button Contact Bushing | 18032.06 |
| 1945-1949 CJ2A, 1948-1953 CJ3A, 1950-1952 M38, 1953-1967 CJ3B, 1953-1971 M38A1, 1955-1966 CJ5, 1955-1966 CJ6, Horn Button Kit (1.25"). Includes: Button, Wiring & Nut | 18032.03 |
| 1960-1975 CJ5, 1960-1975 CJ6, Horn Button Kit (2-1/4"). Includes: Button, Wiring & Nut | 18032.04 |
| 1960-1975 CJ5, 1960-1975 CJ6, Horn Button (2-1/4") | 18032.05 |
| 1976-1983 CJ5, 1976-1986 CJ7, 1981-1986 CJ8, 1987-1995 Wrangler, Horn Button, Black | 18033.01 |

C. Steering Shafts & Components Part#

| | |
|---|----------|
| 1941-1945 MB, 1941-1945 Ford GPW, 1945-1949 CJ2A, 1946-1951 Station Wagon (With Planar Suspension), 1948-1953 CJ3A, 1948-1951 Jeepster, 1953-1967 CJ3B, 1955-1971 CJ5, 1955-1971 CJ6, Worm Shaft Bearing Kit (134 CI) | 18029.01 |
| 1941-1945 MB, 1941-1945 Ford GPW, 1945-1949 CJ2A, 1946-1951 Station Wagon (With Planar Suspension), 1948-1953 CJ3A, 1948-1951 Jeepster, 1953-1967 CJ3B, 1955-1971 CJ5, 1955-1971 CJ6, Steering Sector Shaft Outer Bushing (134 CI) | 18029.05 |
| 1941-1945 MB, 1941-1945 Ford GPW, 1945-1949 CJ2A, 1946-1951 Station Wagon (With Planar Suspension), 1948-1953 CJ3A, 1948-1951 Jeepster, 1953-1967 CJ3B, 1955-1971 CJ5, 1955-1971 CJ6, Steering Sector Shaft Inner Bushing (134 CI) | 18029.06 |
| 1941-1945 MB, 1941-1945 Ford GPW, 1945-1949 CJ2A, 1946-1951 Station Wagon (With Planar Suspension), 1948-1953 CJ3A, 1948-1951 Jeepster, 1953-1967 CJ3B, 1955-1971 CJ5, 1955-1971 CJ6, Steering Sector Shaft Repair Kit (134 CI), For 7/8" Shaft, Includes: Sector Shaft, Bushings, & Gaskets NEW | 18027.01 |
| 1941-1945 MB, 1941-1945 Ford GPW, 1945-1948 CJ2A, Worm Shaft (40.5") * NEW | 18028.01 |
| 1948-1949 CJ2A, 1948-1953 CJ3A, 1953-1967 CJ3B, 1955-1971 CJ5, 1955-1971 CJ6, Worm Shaft (41.5"). For 134 CI * NEW | 18028.02 |
| 1950-1952 M38, 1953-1971 M38A1, 1967-1971 CJ5 (225 CI), 1967-1971 CJ6 (225 CI), Sector Shaft Oil Seal | 18029.04 |
| 1950-1952 M38, 1953-1971 M38A1, 1967-1971 CJ5 (225 CI), 1967-1971 CJ6 (225 CI) Sector Shaft Bushing (Long) | 18029.07 |
| 1950-1952 M38, 1953-1971 M38A1, 1967-1971 CJ5 (225 CI), 1967-1971 CJ6 (225 CI) Sector Shaft Bushing (Short) | 18029.08 |
| 1972-1983 CJ5, 1972-1975 CJ6, 1976-1986 CJ7, 1981-1986 CJ8, 1973-1983 Cherokee / Grand Wagoneer (SJ), Sector Shaft Bushing (Manual) | 18002.02 |
| 1972-1983 CJ5, 1972-1975 CJ6, 1976-1986 CJ7, 1981-1986 CJ8, 1973-1983 Cherokee / Grand Wagoneer (SJ), Steering Sector Shaft Oil Seal (Manual) | 18002.03 |
| 1972-1983 CJ5, 1972-1975 CJ6, 1976-1986 CJ7, 1981-1986 CJ8, 1973-1983 Cherokee / Grand Wagoneer (SJ), Steering Worm Shaft Oil Seal (Manual) | 18002.04 |
| 1972-1975 CJ5, 1972-1975 CJ6, Steering Shaft Yoke Assembly, Includes U-Joint UPGRADE-NEW | 18017.01 |
| 1972-1975 CJ5, 1972-1975 CJ6, Steering Shaft Yoke Assembly U-Joint UPGRADE | 18017.02 |
| 1984-1986 CJ7, 1984-1986 CJ8, 1984-1996 Cherokee, 1987-1995 Wrangler, 1984-1991 Cherokee / Grand Wagoneer (SJ), Steering Column Sector Kit (Without Tilt Column) | 18020.02 |
| 1976-1983 CJ5, 1976-1986 CJ7, 1981-1986 CJ8, Lower Steering Shaft Assembly (Manual) | 18016.01 |
| 1976-1983 CJ5, 1976-1986 CJ7, 1981-1986 CJ8, Lower Steering Shaft Assembly (Power) | 18016.02 |
| 1987-1995 Wrangler, Lower Steering Shaft Assembly (Power) | 18016.03 |
| 1976-1983 CJ5, 1976-1986 CJ7, 1981-1986 CJ8, Lower Steering Shaft Assembly (Manual), Heavy Duty | 18024.01 |
| 1976-1983 CJ5, 1976-1986 CJ7, 1981-1986 CJ8, Lower Steering Shaft Assembly (Power), Heavy Duty | 18024.02 |
| 1976-1983 CJ5, 1976-1986 CJ7, 1981-1986 CJ8, Steering Shaft Coupling Boot | 18018.01 |
| 1976-1983 CJ5, 1976-1986 CJ7, 1981-1986 CJ8, Steering Shaft Coupling Boot Kit, Includes: Spring Clamp & Nut Bearings | 18018.02 |
| 1976-1983 CJ5, 1976-1986 CJ7, 1981-1986 CJ8, Steering Shaft Coupling (Manual) | 18018.03 |
| 1976-1983 CJ5, 1976-1986 CJ7, 1981-1986 CJ8, Steering Shaft Coupling Kit (Manual) | 18018.04 |
| 1976-1983 CJ5, 1976-1986 CJ7, 1981-1986 CJ8, Steering Shaft Coupling (Power) | 18018.05 |
| 1976-1983 CJ5, 1976-1986 CJ7, 1981-1986 CJ8, Steering Shaft Coupling Kit (Power) | 18018.06 |
| 1976-1983 CJ5, 1976-1986 CJ7, 1981-1986 CJ8, Steering Shaft Coupling Clamp | 18018.07 |
| 1976-1983 CJ5, 1976-1986 CJ7, 1981-1986 CJ8, Steering Shaft Coupling Nut Bearings | 18018.08 |
| 1976-1983 CJ5, 1976-1986 CJ7, 1981-1986 CJ8, Steering Shaft Coupling Spring | 18018.09 |

* CJ2A Before Serial 178631 + CJ2A After Serial 178631

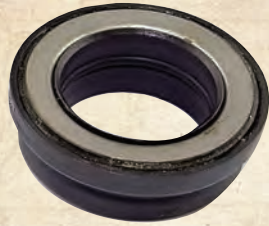

[D] 18019.01



[E] 18001.01



[F] 18004.04



[G] 18029.02

D. Steering Column Components

| Part# | Part# |
|--|----------|
| 1945-1949 CJ2A, 1948-1953 CJ3A, 1950-1952 M38, 1953-1967 CJ3B, 1953-1971 M38A1, 1955-1966 CJ5, 1955-1966 CJ6, Outer Steering Column Tube | 18030.01 |
| 1945-1949 CJ2A, 1948-1953 CJ3A, 1950-1952 M38, 1953-1967 CJ3B, 1953-1971 M38A1, 1955-1971 CJ5, 1955-1971, Upper Steering Column Bearing | 18030.02 |
| 1976-1983 CJ5, 1976-1986 CJ7, 1981-1986 CJ8, 1987-1995 Wrangler, Lower Steering Column Bearing | 18019.01 |
| 1976-1983 CJ5, 1976-1986 CJ7, 1981-1986 CJ8, 1987-1995 Wrangler, Lower Steering Column Retainer, Plastic | 18019.02 |
| 1976-1983 CJ5, 1976-1986 CJ7, 1981-1986 CJ8, 1987-1995 Wrangler, Lower Steering Column Retainer & Bearing Kit | 18019.03 |
| 1976-1983 CJ5, 1976-1986 CJ7, 1981-1986 CJ8, Steering Column Cover, Stainless Steel, Plastic | 11128.01 |
| 1976-1983 CJ5, 1976-1986 CJ7, 1981-1986 CJ8, Steering Column Cover, Black, Plastic | 13318.08 |
| 1976-1983 CJ5, 1976-1986 CJ7, 1981-1986 CJ8, Steering Column Cover, Chrome, Plastic | 18090.01 |
| 1976-1983 CJ5, 1976-1986 CJ7, 1981-1986 CJ8, 1987-1995 Wrangler, Steering Column to Firewall Seal | 18020.01 |

E. Manual Steering Boxes

| Part# | Part# |
|--|----------|
| 1972-1983 CJ5, 1972-1975 CJ6, 1976-1986 CJ7, 1981-1986 CJ8, 1973-1983 Cherokee / Grand Wagoneer [SJ], Steering Gear Box [Manual] NEW | 18001.01 |
| 1972-1983 CJ5, 1972-1975 CJ6, 1976-1986 CJ7, 1981-1986 CJ8, 1973-1983 Cherokee / Grand Wagoneer [SJ], 1972-1984 DJ5, Steering Gear Box [Manual], RHD | 18001.02 |
| 1984-1996 Cherokee, 1987-1999 Wrangler, Steering Box [Manual] NEW | 18001.03 |

F. Power Steering Boxes

| Part# | Part# |
|---|----------|
| 1972-1979 CJ5, 1972-1975 CJ6, 1976-1979 CJ7, Steering Box [Power] * | 18004.71 |
| 1980-1983 CJ5, 1980-1986 CJ7, 1981-1986 CJ8, Steering Box [Power] * | 18004.72 |
| 1984-1990 Cherokee, 1987-1995 Wrangler, Steering Box [Power] | 18004.02 |
| 1987-1995 Wrangler, Steering Box [Power] * | 18004.73 |
| 1991-1996 Cherokee, Steering Box [Power] | 18004.04 |
| 1993-1998 Cherokee [5.2L & 5.9L], Steering Box [Power], With or Without Towing Option | 18004.05 |
| 1997-2002 Wrangler, Steering Box [Power] NEW | 18004.10 |
| 1997-2001 Cherokee, Steering Box [Power] | 18004.08 |
| 1999-2004 Grand Cherokee [4.0L, & 4.7L], Steering Box [Power] | 18004.06 |
| 1999-2004 Grand Cherokee [4.0L, & 4.7L], Steering Box [Power], RHD | 18004.09 |
| 2003-2004 Grand Cherokee [Export Models], Steering Box [Power] | 18004.07 |

G. Steering Gear Components

| Part# | Part# |
|--|----------|
| 1941-1945 MB, 1941-1945 Ford GPW, 1945-1949 CJ2A, 1946-1951 Station Wagon [With Planar Suspension], 1948-1953 CJ3A, 1948-1951 Jeepster, 1950-1952 M38, 1953-1967 CJ3B, 1953-1971 M38A1, 1955-1971 CJ5, 1955-1971 CJ6, Ross Steering Box Shim Set | 18029.02 |
| 1941-1945 MB, 1941-1945 Ford GPW, 1945-1949 CJ2A, 1946-1951 Station Wagon [With Planar Suspension], 1948-1953 CJ3A, 1948-1951 Jeepster, 1953-1967 CJ3B, 1955-1971 CJ5, 1955-1971 CJ6, Steering Box Oil Seal [134 CI] | 18029.03 |
| 1987-1995 Wrangler, 1993-1996 Grand Cherokee, 1973-1991 Cherokee / Grand Wagoneer [SJ], Steering Box Valve Ring & Seal [Power] | 18005.01 |
| 1987-1995 Wrangler, 1993-1996 Grand Cherokee, 1973-1991 Cherokee / Grand Wagoneer [SJ], Rotating Stub Shaft Seal Kit [Power] | 18005.02 |
| 1987-1995 Wrangler, 1993-1996 Grand Cherokee, 1973-1991 Cherokee / Grand Wagoneer [SJ], Steering Box Pitman Arm Seal Kit [Power] | 18005.03 |



OMIX-ADA, Inc.

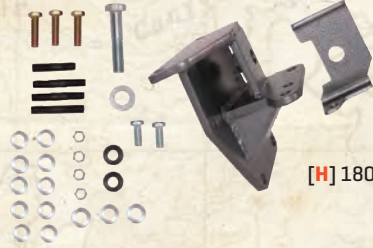

[H] 18003.10



[I] 18008.14



[J] 18010.02

H. Steering Box Mounts & Brackets

| Part# | Part# |
|--|----------|
| 1972-1975 CJ5, 1972-1975 CJ6, Steering Box Brace | 18021.01 |
| 1976-1983 CJ5, 1976-1976 CJ7, 1981-1986 CJ8, Steering Box Brace [Power], Heavy Duty | 18021.02 |
| 1976-1983 CJ5, 1976-1976 CJ7, 1981-1986 CJ8, Steering Box Tie Plate [Manual] | 18003.01 |
| 1976-1983 CJ5, 1976-1976 CJ7, 1981-1986 CJ8, Steering Box Brace [Manual or Power], Upper | 18003.02 |
| 1976-1983 CJ5, 1976-1976 CJ7, 1981-1986 CJ8, Steering Box Brace [Manual or Power], Lower | 18003.03 |
| 1976-1983 CJ5, 1976-1976 CJ7, 1981-1986 CJ8, Steering Box Mount [Power], Heavy Duty | 18003.10 |
| 1984-2001 Cherokee, Steering Box Brace, Heavy Duty | 18021.05 |

I. Power Steering Pumps

| Part# | Part# |
|---|----------|
| 1980-1983 CJ5, 1980-1986 CJ7, 1981-1986 CJ8, Power Steering Pump [2.5L GM, 2.5L AMC, 4.2L & 5.0L] * | 18008.03 |
| 1987-1989 Cherokee [4.0L], Power Steering Pump | 18008.20 |
| 1990 Cherokee [4.0L], Power Steering Pump | 18008.14 |
| 1991-1995 Wrangler [2.5L & 4.0L], Power Steering Pump | 18008.04 |
| 1991-1995 Cherokee [2.5L w/ EFI], Power Steering Pump | 18008.06 |
| 1991-1996 Cherokee [2.5L w/ Carb], Power Steering Pump | 18008.16 |
| 1991-1996 Cherokee [4.0L], 1994-1996 Grand Cherokee [4.0L] | 18009.01 |
| 1997 Wrangler [4.0L], Power Steering Pump Reservoir NEW | 18008.10 |
| 1993-1995 Grand Cherokee [5.2L], 1996-1998 Grand Cherokee [5.2L & 5.9L W/o Speed Proportional Steering], Power Steering Pump | 18008.09 |
| 1994-1997 Cherokee [Export Models], Power Steering Pump | 18008.08 |
| 1996-1998 Cherokee [4.0L], Power Steering Pump | 18008.11 |
| 1997-2002 Wrangler [2.5L], Power Steering Pump | 18008.17 |
| 1997-2006 Wrangler [4.0L], 1997-2002 Wrangler [2.5L], 1997-2001 Cherokee [4.0L], 1997-2000 Cherokee [2.5L], 1997-2004 Grand Cherokee [4.0L & 4.7L], Power Steering Pump Pulley NEW | 18011.01 |
| 2001-2004 Grand Cherokee [4.0L], Power Steering Pump | 18008.15 |
| 2001-2004 Grand Cherokee [4.7L], Power Steering Pump | 18008.13 |
| 2002-2006 Liberty [3.7L], Power Steering Pump | 18008.12 |
| 2003-2006 Wrangler [2.4L], Power Steering Pump | 18008.19 |
| 2007-2008 Grand Cherokee [5.7L], Power Steering Reservoir NEW | 18009.02 |

J. Power Steering Pump Seals

| Part# | Part# |
|---|----------|
| 1987-1990 4.0L Cherokee, Saginaw Power Steering Pump Seal Kit | 18010.01 |
| 1987-1995 Wrangler, 1987-1996 Cherokee, 1993-1996 Grand Cherokee, Power Steering Pump Adjusting Plunge Seal Kit | 18010.02 |
| 1987-1995 Wrangler, 1987-1996 Cherokee, 1993-1996 Grand Cherokee, Power Steering Pump Valve Ring Seal Kit | 18010.04 |
| 1987-1995 Wrangler, 1987-1996 Cherokee, 1993-1996 Grand Cherokee, Power Steering Pump Seal Kit | 18010.05 |
| 1997-2002 Wrangler, 1997-2001 Cherokee, 1997-1998 Grand Cherokee, Power Steering Pump Pitman Arm Seal Kit, | 18010.03 |

All images are subject to be representative. More detailed information is available online.

* Remanufactured + Reservoir Not Included



| K. Power Steering Pressure Hoses | Part# |
|--|----------|
| 1976-1979 CJ5 (3.8L, 4.2L & 5.0L), 1976-1979 CJ7 (3.8L, 4.2L & 5.0L), Power Steering Pressure Hose | 18012.01 |
| 1980-1983 CJ5 (4.2L), 1980-1986 CJ7 (4.2L), 1981-1986 CJ8 (4.2L), Power Steering Pressure Hose | 18012.02 |
| 1980-1981 CJ5 (5.0L), 1980-1981 CJ7 (5.0L), 1981 CJ8 (5.0L), Power Steering Pressure Hose | 18012.03 |
| 1984-1985 Cherokee (2.5L), Power Steering Pressure Hose | 18012.08 |
| 1984-1986 Cherokee (2.8L), Power Steering Pressure Hose | 18012.08 |
| 1986 Cherokee (2.5L), Power Steering Pressure Hose | 18012.09 |
| 1987-1990 Wrangler (2.5L), Power Steering Pressure Hose | 18012.05 |
| 1987-1990 Wrangler (4.0L), Power Steering Pressure Hose | 18012.04 |
| 1987-1990 Cherokee (4.0L), Power Steering Pressure Hose | 18012.10 |
| 1991-1995 Wrangler (2.5L), Power Steering Pressure Hose | 18012.07 |
| 1991-1995 Wrangler (4.0L), Power Steering Pressure Hose | 18012.06 |
| 1991-1996 Cherokee (4.0L), 1993-1996 Grand Cherokee, Power Steering Pressure Hose | 18012.11 |
| 1993-1998 Grand Cherokee, (4.0L), 1993-1995 Grand Cherokee, (5.2L), 1996-1998 Grand Cherokee (5.2L & 5.9L w/o Speed Proportional Steering), Power Steering Pressure Hose | 18012.14 |
| 1996-1998 Grand Cherokee (5.2L & 5.9L w/ Speed Proportional Steering), Power Steering Pressure Hose | 18012.15 |
| 1997-2002 Wrangler (2.5L), Power Steering Pressure Hose | 18012.13 |
| 1997-2002 Wrangler (4.0L), Power Steering Pressure Hose | 18012.17 |
| 1997-2001 Cherokee (4.0L), Power Steering Pressure Hose | 18012.12 |
| 1999-2004 Grand Cherokee (4.0L), Power Steering Pressure Hose NEW | 18012.19 |
| 1999-2000 Grand Cherokee (4.7L), Power Steering Pressure Hose | 18012.16 |
| 2001-2004 Grand Cherokee (4.7L), Power Steering Pressure Hose NEW | 18012.21 |
| 2002-2003 Liberty (3.7L), Power Steering Pressure Hose NEW | 18012.20 |
| 2003-2006 Wrangler (4.0L), Power Steering Pressure Hose NEW | 18012.18 |

| L. Power Steering Return Hoses | Part# |
|---|----------|
| 1976-1979 CJ5 (3.8L, 4.2L & 5.0L), 1976-1979 CJ7 (3.8L, 4.2L & 5.0L), Power Steering Return Hose | 18014.01 |
| 1980-1983 CJ5 (4.2L), 1980-1986 CJ7 (4.2L), 1981-1986 CJ8 (4.2L), Power Steering Return Hose | 18014.02 |
| 1980-1981 CJ5 (5.0L), 1980-1981 CJ7 (5.0L), 1981 CJ8 (5.0L), Power Steering Return Hose | 18014.03 |
| 1983 CJ5 (2.5L AMC), 1983-1986 CJ7 (2.5L AMC), 1983-1986 CJ8 (2.5L AMC), Power Steering Return Hose | 18014.13 |
| 1987-1990 Cherokee (4.0L), Power Steering Return Hose | 18014.07 |
| 1991-1995 Wrangler (4.0L), Power Steering Return Hose, Pump to Reservoir Connection | 18014.06 |
| 1991-1995 Wrangler (4.0L), Power Steering Return Hose | 18014.11 |
| 1991-2001 Cherokee (4.0L), Power Steering Return Hose | 18014.11 |
| 1993-1998 Grand Cherokee (4.0L, 5.2L & 5.9L), Power Steering Return Hose | 18014.09 |
| 1997-2002 Wrangler (4.0L), Power Steering Return Hose | 18014.08 |
| 1998-2000 Cherokee (2.5L), Power Steering Return Hose | 18014.10 |
| 1999-2000 Grand Cherokee (4.7L Without PS Cooler), Power Steering Return Hose | 18014.12 |

| M. Pitman Arms | Part# |
|---|----------|
| 1941-1945 MB, 1941-1945 Ford GPW, 1945-1949 CJ2A, 1948-1953 CJ3A, 1953-1967 CJ3B, 1955-1971 CJ5, 1955-1971, Pitman Arm [134 CI] | 18006.30 |
| 1976-1983 CJ5, 1976-1986 CJ7, 1981-1986 CJ8, Pitman Arm [Manual] | 18006.02 |
| 1976-1983 CJ5, 1976-1986 CJ7, 1981-1986 CJ8, Pitman Arm [Power] | 18006.01 |
| 1976-1983 CJ5, 1976-1986 CJ7, 1981-1986 CJ8, Pitman Arm [Power], With Up to 4" Lift | 18006.51 |
| 1984-2001 Cherokee, Pitman Arm [Power] | 18006.08 |
| 1987-1995 Wrangler, Pitman Arm [Manual] | 18006.04 |
| 1987-1995 Wrangler, Pitman Arm [Power] | 18006.03 |
| 1987-2006 Wrangler, Pitman Arm [Power], With 4" -6" Lift | 18006.50 |
| 1993-1998 Grand Cherokee, Pitman Arm [Power] | 18006.09 |
| 1997-2006 Wrangler, Pitman Arm [Manual] | 18006.06 |
| 1997-2006 Wrangler, Pitman Arm [Power] | 18006.05 |
| 1999-2004 Grand Cherokee, Pitman Arm [Power] | 18006.10 |
| 2007-2011 Wrangler, Pitman Arm [LHD] NEW | 18006.11 |

| N. Steering Stabilizers | Part# |
|---|----------|
| 1974-1991 Cherokee / Grand Wagoneer, Steering Stabilizer | 18040.02 |
| 1955-1983 CJ5, 1955-1975 CJ6, 1976-1986 CJ7, 1981-1986 CJ8, Steering Stabilizer | 18040.01 |
| 1984-2001 Cherokee, 1987-2006 Wrangler, 1993-1998 Grand Cherokee, Steering Stabilizer | 18040.03 |
| 1994-2004 Grand Cherokee, Steering Stabilizer | 18040.04 |
| 2007-2011 Wrangler, Steering Stabilizer NEW | 18040.05 |

| O. Steering Knuckle Components | Part# |
|--|----------|
| 1941-1945 MB, 1941-1945 Ford GPW, 1945-1949 CJ2A, 1948-1953 CJ3A, 1950-1952 M38, 1953-1967 CJ3B, 1953-1971 M38A1, 1955-1971 CJ5, 1955-1971, Steering Knuckle, Left | 18026.01 |
| 1941-1945 MB, 1941-1945 Ford GPW, 1945-1949 CJ2A, 1948-1953 CJ3A, 1950-1952 M38, 1953-1967 CJ3B, 1953-1971 M38A1, 1955-1971 CJ5, 1955-1971, Steering Knuckle, Right | 18026.02 |
| 1941-1945 MB, 1941-1945 Ford GPW, 1945-1949 CJ2A, 1948-1953 CJ3A, 1950-1952 M38, 1953-1967 CJ3B, 1953-1971 M38A1, 1955-1971 CJ5, 1955-1971, Steering Knuckle Seal Kit, LH or RH | 18026.03 |
| 1941-1945 MB, 1941-1945 Ford GPW, 1945-1949 CJ2A, 1948-1953 CJ3A, 1950-1952 M38, 1953-1967 CJ3B, 1953-1971 M38A1, 1955-1971 CJ5, 1955-1971, Steering Knuckle King Pin Bearing Cap, LH or RH | 18026.04 |
| 1941-1945 MB, 1941-1945 Ford GPW, 1945-1949 CJ2A, 1948-1953 CJ3A, 1950-1952 M38, 1953-1967 CJ3B, 1953-1971 M38A1, 1955-1971 CJ5, 1955-1971, Steering Knuckle King Pin Bearing, LH or RH | 18026.05 |
| 1941-1945 MB, 1941-1945 Ford GPW, 1945-1949 CJ2A, 1948-1953 CJ3A, 1950-1952 M38, 1953-1967 CJ3B, 1953-1971 M38A1, 1955-1971 CJ5, 1955-1971, Steering Knuckle King Pin Bearing, LH or RH | 18026.06 |
| 1941-1945 MB, 1941-1945 Ford GPW, 1945-1949 CJ2A, 1948-1953 CJ3A, 1950-1952 M38, 1953-1967 CJ3B, 1953-1971 M38A1, 1955-1971 CJ5, 1955-1971, Steering Knuckle King Pin Bearing Shim Set, LH or RH | 18026.07 |
| 1974-1991 Cherokee / Grand Wagoneer [SJ], Spindle Washer | 16527.35 |
| 1974-1991 Cherokee / Grand Wagoneer [SJ], Spindle Inner Nut | 16527.36 |
| 1974-1991 Cherokee / Grand Wagoneer [SJ], Spindle Outer Nut | 16527.37 |

1941-71 MB, M38 & CJ Tie Rod Assemblies & Components

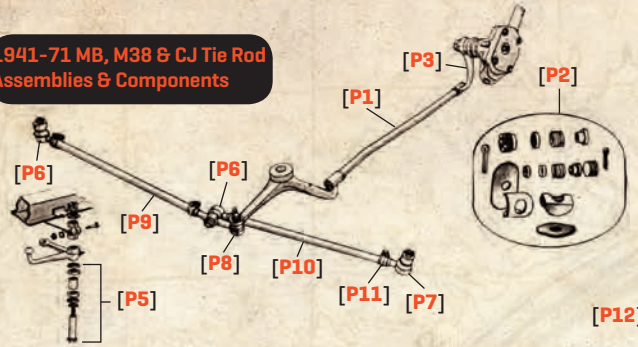

1987-06 Wrangler Tie Rod Assemblies & Components

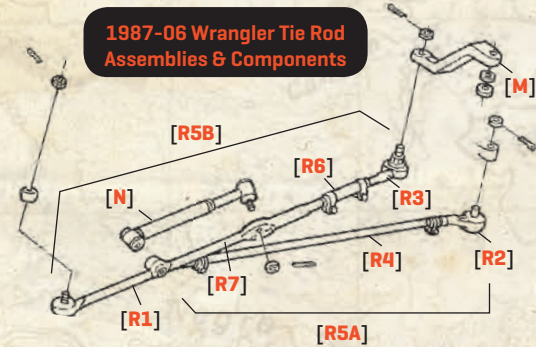

P. 1941-1971 Steering Linkage

| | Part# | |
|----|--|----------|
| 3 | 1941-1945 MB, 1941-1945 Ford GPW, 1948-1949 CJ2A, 1948-1953 CJ3A, 1953-1967 CJ3B, 1955-1971 CJ5, 1955-1971 CJ6, [134 CI], [Pitman Arm] | 18006.30 |
| 1 | 1948-1949 CJ2A, 1948-1953 CJ3A, 1953-1967 CJ3B, 1955-1971 CJ5, 1955-1971 CJ6, Steering Drag Link [134 CI], [Runs from Pitman Arm to Bellcrank] * | 18041.01 |
| 1 | 1941-1945 MB, 1941-1945 Ford GPW, 1945-1948 CJ2A, Steering Drag Link, [Runs from Pitman Arm to Bellcrank] + | 18041.03 |
| 2 | 1948-1949 CJ2A, 1948-1953 CJ3A, 1953-1967 CJ3B, 1955-1971 CJ5, 1955-1971 CJ6, Steering Drag Link Repair Kit [134 CI] | 18041.02 |
| 5 | 1941-1945 MB, 1941-1945 Ford GPW, 1945-1948 CJ2A, Steering Drag Link Repair Kit + | 18042.02 |
| 5 | 1948-1949 CJ2A, 1948-1953 CJ3A, 1953-1967 CJ3B, 1955-1971 CJ5, 1955-1971 CJ6, Steering Drag Link Repair Link [134 CI], [Runs from Pitman Arm to Bellcrank] * | 18042.03 |
| 7 | 1950-1952 M38, 1953-1971 M38A1, Tie Rod, Left, 3/4" Thread | 18043.01 |
| 6 | 1950-1952 M38, 1953-1971 M38A1, Tie Rod, Right, 3/4" Thread | 18043.02 |
| 7 | 1941-1945 MB, 1941-1945 Ford GPW, 1945-1949 CJ2A, 1948-1953 CJ3A, 1953-1967 CJ3B, 1955-1971 CJ5, 1955-1971 CJ6, Tie Rod, Left, 11/16" Thread | 18043.03 |
| 6 | 1941-1945 MB, 1941-1945 Ford GPW, 1945-1949 CJ2A, 1948-1953 CJ3A, 1953-1967 CJ3B, 1955-1971 CJ5, 1955-1971 CJ6, Tie Rod, Right, 11/16" Thread | 18043.04 |
| 8 | 1950-1952 M38, 1953-1971 M38A1, Tie Rod, RH Inner | 18045.01 |
| 8 | 1941-1945 MB, 1941-1945 Ford GPW, 1945-1949 CJ2A, 1948-1953 CJ3A, 1953-1967 CJ3B, 1955-1971 CJ5, 1955-1971 CJ6, Tie Rod, RH Inner | 18045.02 |
| 9 | 1945-1949 CJ2A, 1948-1953 CJ3A, 1953-1967 CJ3B, 1955-1971 CJ5, 1955-1971 CJ6, Tie Rod Assembly, Right [24.5"] | 18046.01 |
| 10 | 1945-1949 CJ2A, 1948-1953 CJ3A, 1953-1967 CJ3B, 1955-1971 CJ5, 1955-1971 CJ6, Tie Rod Assembly, Left [19.75"] | 18046.02 |
| 11 | 1945-1949 CJ2A, 1948-1953 CJ3A, 1953-1967 CJ3B, 1955-1971 CJ5, 1955-1971 CJ6, Tie Rod Adjusting Sleeve [4 Required] | 18047.01 |
| 12 | 1945-1949 CJ2A, 1948-1953 CJ3A, 1953-1967 CJ3B, 1955-1971 CJ5, 1955-1971 CJ6, Tie Rod Boot | 18048.01 |

R. 1987-2006 Wrangler Steering Linkage

| | Part# | |
|----|--|----------|
| 1 | 1987-1990 Wrangler, Tie Rod End, LH Thread, At Pitman Arm | 18043.05 |
| 1 | 1991-2006 Wrangler, Tie Rod End, LH Thread, At Pitman Arm | 18043.06 |
| 2 | 1987-1990 Wrangler, Tie Rod, Inner, RH Thread | 18043.07 |
| 2 | 1991-2006 Wrangler, Tie Rod, Inner, RH Thread | 18043.08 |
| 3 | 1987-1990 Wrangler, Tie Rod, Left, LH Thread | 18043.09 |
| 3 | 1991-2006 Wrangler, Tie Rod, Left, LH Thread | 18043.10 |
| 4 | 1987-1990 Wrangler, Drag Link Tube [25.82"], Pitman Arm To Tie Rod End | 18050.03 |
| 4 | 1991-1995 Wrangler, Drag Link Tube [24.11"], Pitman Arm To Tie Rod End | 18050.04 |
| 4 | 1997-2006 Wrangler, Drag Link Tube [34.68], Left Side to Tie Rod | 18050.05 |
| 5 | 1997-2006 Wrangler, Tie Rod Kit, Heavy Duty, Includes: LH & RH Tie Rods UPGRADE | 18050.51 |
| 5 | 1987-1995, Drag Link Kit, Heavy Duty UPGRADE | 18050.52 |
| 5A | 1987-1990 Wrangler, Drag Link Kit, Includes: Tube & [2] Tie Rods | 18052.03 |
| 5A | 1991-1995 Wrangler, Drag Link Kit, Includes: Tube & [2] Tie Rods | 18052.04 |
| 5A | 1997-2006 Wrangler, Drag Link Kit, Includes: Tube & [2] Tie Rods | 18052.05 |
| 5B | 1987-1990 Wrangler, Tie Rod Kit, Includes: Adjusting Sleeve, LH & RH Tie Rods | 18054.03 |
| 5B | 1991-1995 Wrangler, Tie Rod Kit, Includes: Adjusting Sleeve, LH & RH Tie Rods | 18054.04 |
| 5B | 1997-2006 Wrangler, Tie Rod Kit, Includes: Adjusting Sleeve, LH & RH Tie Rods | 18054.05 |
| 6 | 1989-1995 Wrangler, Tie Rod Adjusting Sleeve | 18056.02 |
| 6 | 1997-2006 Wrangler, Tie Rod Adjusting Sleeve | 18056.03 |
| 7 | 1987-1990 Wrangler, Tie Rod, Right | 18058.03 |
| 7 | 1991-1995 Wrangler, Tie Rod, Right | 18058.04 |
| 7 | 1997-2006 Wrangler, Tie Rod, Right | 18058.05 |
| 8 | 1997-2006 Wrangler, Sway Bar End Link [Front], LH or RH NEW | 18274.05 |
| 8 | 1997-2006 Wrangler, Sway Bar End Link [Rear], LH or RH NEW | 18274.06 |

1972-86 CJ Tie Rod Assemblies & Components

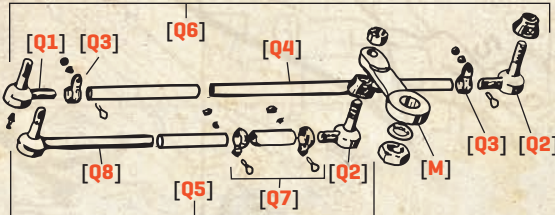

Q. 1972-1986 CJ Steering Linkage

| | Part# | |
|---|---|----------|
| 1 | 1972-1983 CJ5, 1972-1975 CJ6, 1976-1986 CJ7, 1981-1986 CJ8, Tie Rod End, Left | 18043.03 |
| 2 | 1972-1983 CJ5, 1972-1975 CJ6, 1976-1986 CJ7, 1981-1986 CJ8, Tie Rod End, Right [2 Required] | 18043.04 |
| 3 | 1972-1983 CJ5, 1972-1975 CJ6, 1976-1986 CJ7, 1981-1986 CJ8, Tie Rod End Clamp [4 Required] | 18047.01 |
| 4 | 1972-1983 CJ5, 1972-1975 CJ6, 1976-1981 CJ7, 1981 CJ8, Tie Rod Assembly [40.50"], Knuckle to Knuckle | 18050.01 |
| 4 | 1982-1986 CJ7, 1982-1986 CJ8, Tie Rod Assembly [43.75"], Knuckle to Knuckle | 18050.02 |
| 5 | 1972-1983 CJ5, 1972-1975 CJ6, 1976-1981 CJ7, 1981 CJ8, Tie Rod Assembly, Pitman Arm to Steering Arm [20"], Heavy Duty w Ends UPGRADE | 18050.56 |
| 5 | 1972-1983 CJ5, 1972-1975 CJ6, 1976-1981 CJ7, 1981 CJ8, Tie Rod Assembly, Pitman Arm to Steering Arm [28-1/8"] w Ends | 18054.01 |
| 5 | 1982-86 CJ7, 1982-1986 CJ8, Tie Rod Assembly, Pitman Arm to Steering Arm w Ends | 18054.02 |
| 6 | 1982-86 CJ7, 1982-1986 CJ8, Long Tie Rod Tube [39.25"] w Ends UPGRADE | 18050.53 |
| 6 | 1972-1983 CJ5, 1972-1975 CJ6, 1976-1981 CJ7, 1981 CJ8, Tie Rod Assembly [36"], Knuckle to Knuckle, Heavy Duty w Ends UPGRADE | 18050.54 |
| 6 | 1972-1983 CJ5, 1972-1975 CJ6, 1976-1981 CJ7, Long Tie Rod Tube [40.05"] Assembly Kit | 18052.01 |
| 6 | 1982-86 CJ7, 1982-1986 CJ8, Long Tie Rod Tube [43.75"] Assembly Kit | 18052.02 |
| 7 | 1972-1983 CJ5, 1972-1975 CJ6, 1976-1986 CJ7, 1981-1986 CJ8, Tie Rod Adjuster Sleeve | 18056.01 |
| 8 | 1972-1983 CJ5, 1972-1975 CJ6, 1976-1981 CJ7, Long Drag Link | 18058.01 |
| 8 | 1982-86 CJ7, 1982-1986 CJ8, Long Tie Rod | 18058.02 |

2007-11 Wrangler Tie Rod Assemblies & Components



S. 2007-2011 Wrangler Steering Linkage

| | Part# | |
|---|--|----------|
| 1 | 2007-2011 Wrangler, Tie Rod, LH, To Pitman Arm NEW | 18044.01 |
| 2 | 2007-2011 Wrangler, Tie Rod Tube, Knuckle to Knuckle NEW | 18044.02 |
| 3 | 2007-2011 Wrangler, Tie Rod, LH, Outer, To Knuckle NEW | 18044.03 |
| 4 | 2007-2011 Wrangler, Tie Rod Tube Adjusting Sleeve, To LH Outer Tied Rod NEW | 18044.04 |
| 5 | 2007-2011 Wrangler, Tie Rod Drag Link, RH NEW | 18044.05 |
| 6 | 2007-2011 Wrangler, Tie Rod Drag Adjusting Sleeve NEW | 18044.06 |
| | 2007-2011 Wrangler, Sway Bar End Link [Rear] LH or RH NEW | 18044.30 |

All images are subject to be representative. More detailed information is available online.

* CJ2A After Serial 199079 † CJ2A Before Serial 199079



OMIX-ADA, Inc.



1984-2001 Cherokee & Grand Cherokee Tie Rod Assemblies & Components

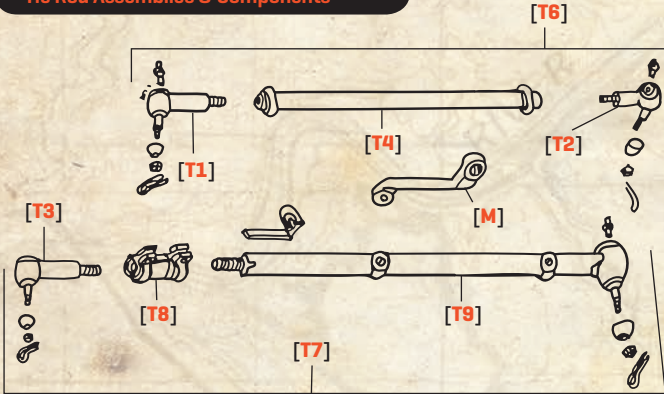

T. 1984-2001 Cherokee & 1993-1998 Grand Cherokee 6 Cylinder Steering Linkage

| | Part# |
|---|----------|
| 1 1984-1990 Cherokee, Tie Rod End, LH Thread, At Pitman Arm | 18043.05 |
| 1 1991-2001 Cherokee, 1993-1998 Grand Cherokee [4.0L], Tie Rod End, LH Thread, At Pitman Arm | 18043.06 |
| 2 1984-2001 Cherokee, Tie Rod, Inner, RH Thread | 18043.07 |
| 2 1993-1998 Grand Cherokee [4.0L], Tie Rod, Inner, RH Thread | 18043.08 |
| 3 1984-2001 Cherokee, Tie Rod, Left, LH Thread | 18043.10 |
| 3 1984-1990 Cherokee, Tie Rod, Left, LH Thread | 18043.11 |
| 4 1991-2001 Cherokee, 1993-1998 Grand Cherokee [4.0L], Drag Link Tube [34.5"], Left to Tie Rod | 18050.05 |
| 4 1984-1990 Cherokee, Drag Link Tube [36.5"], Left to Tie Rod | 18050.06 |
| 5 1984-2001 Cherokee, Tie Rod Kit, Heavy Duty UPGRADE | 18050.82 |
| 6 1993-1998 Grand Cherokee, Drag Link Kit | 18052.05 |
| 6 1984-1990 Cherokee, Drag Link Kit | 18052.06 |
| 6 1991-2001 Cherokee, Drag Link Kit | 18052.07 |
| 7 1984-1990 Cherokee, Tie Rod Kit | 18054.06 |
| 7 1991-2001 Cherokee, Tie Rod Kit | 18054.07 |
| 7 1993-1998 Grand Cherokee, Tie Rod Kit | 18054.08 |
| 8 1991-2001 Cherokee, 1993-1998 Grand Cherokee [4.0L] Tie Rod Adjusting Sleeve | 18056.03 |
| 8 1984-1990 Cherokee, Tie Rod Adjusting Sleeve | 18056.04 |
| 8 1993-1998 Grand Cherokee [5.2L & 5.9L], Adjusting Sleeve | 18056.03 |
| 9 1984-1990 Cherokee, Tie Rod, Right, Outer | 18058.06 |
| 9 1991-2001 Cherokee, Tie Rod, Right, Outer | 18058.07 |
| 9 1993-1998 Grand Cherokee, Tie Rod, Right, Outer | 18058.08 |
| 1984-1990 Cherokee, Track Bar, With Bushings | 18205.03 |
| 1991-2001 Cherokee, 1993-1998 Grand Cherokee [4.0L], Track Bar, With Bushings | 18205.04 |
| 1991-2001 Cherokee, 1993-1998 Grand Cherokee [4.0L], Adjustable Track Bar, With Bushings UPGRADE | 18205.05 |

U. 1993-1998 V8 Grand Cherokee Steering Linkage

| | Part# |
|---|----------|
| 10 1993-1998 Grand Cherokee [5.2L & 5.9L], Tie Rod, LH Outer, LH Thread | 18043.10 |
| 11 1993-1998 Grand Cherokee [5.2L & 5.9L], Tie Rod Kit, Heavy Duty UPGRADE | 18050.82 |
| 12 1993-1998 Grand Cherokee [5.2L & 5.9L], Tie Rod Kit | 18052.08 |
| 13 1993-1998 Grand Cherokee [5.2L & 5.9L], Drag Link Kit | 18054.09 |
| 14 1993-1998 Grand Cherokee [5.2L & 5.9L], Tie Rod, Outer to Knuckle | 18058.09 |
| 15 1993-1998 Grand Cherokee [5.2L & 5.9L], Drag Link | 18058.10 |
| 16 1993-1998 Grand Cherokee [5.2L & 5.9L], Adjustable Track Bar, With Bushings | 18205.05 |

Steering

1993-98 (5.2L or 5.9L) Grand Cherokee Tie Rod Assemblies & Components

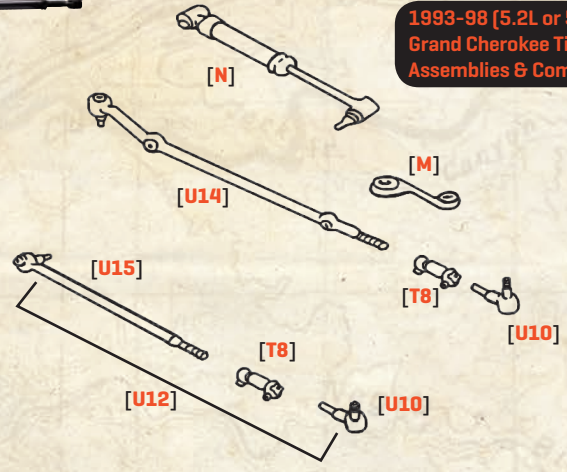

1999-04 Grand Cherokee Tie Rod Assemblies & Components

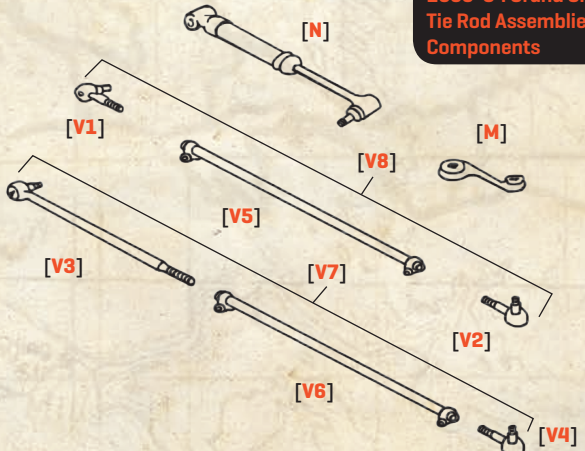

V. 1999-2010 Grand Cherokee Steering Linkage

| | Part# |
|--|----------|
| 1 1999-2004 Grand Cherokee, Tie Rod, Outer RH To Drag Link | 18043.12 |
| 2 1999-2004 Grand Cherokee, Tie Rod, LH At Pitman Arm | 18043.13 |
| 3 1999-2004 Grand Cherokee, Tie Rod, Outer RH To Knuckle [Long] | 18043.14 |
| 4 1999-2004 Grand Cherokee, Tie Rod, Outer LH To Knuckle | 18043.15 |
| 5 1999-2004 Grand Cherokee, Drag Link | 18050.08 |
| 6 1999-2004 Grand Cherokee, Tie Rod Tube, Knuckle to Knuckle | 18050.09 |
| 7 1999-2004 Grand Cherokee, Tie Rod Kit | 18052.09 |
| 8 1999-2004 Grand Cherokee, Drag Link Kit | 18052.10 |
| 1999-2004 Grand Cherokee, Track Bar | 18205.06 |
| 2005-2010 Grand Cherokee, Tie Rod, RH NEW | 18283.20 |
| 2005-2010 Grand Cherokee, Tie Rod, LH NEW | 18283.21 |
| 2005-2010 Grand Cherokee, Sway Bar End Link (Front), LH or RH NEW | 18283.22 |

W. 2002-2007 Liberty Steering Linkage

| | Part# |
|--|----------|
| 2002-05 Liberty, Outer Tie Rod End, RH | 18043.16 |
| 2002-05 Liberty, Outer Tie Rod End, LH | 18043.17 |

X. 1974-1991 (SJ) Steering Linkage

| | Part# |
|--|----------|
| 1974-1991 Cherokee / Grand Cherokee [SJ], Tie Rod, LH, To Pitman Arm NEW | 18043.21 |
| 1974-1991 Cherokee / Grand Cherokee [SJ], Tie Rod [46.5"], RH, To Knuckle NEW | 18043.23 |
| 1974-1991 Cherokee / Grand Cherokee [SJ], Tie Rod, LH, To Knuckle NEW | 18043.24 |
| 1974-1986 Cherokee / Grand Cherokee [SJ], Tie Rod [50.5"], RH, To Knuckle NEW | 18043.25 |

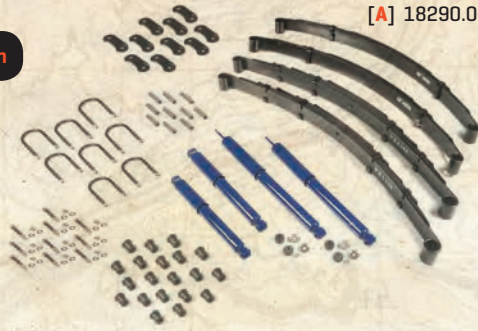
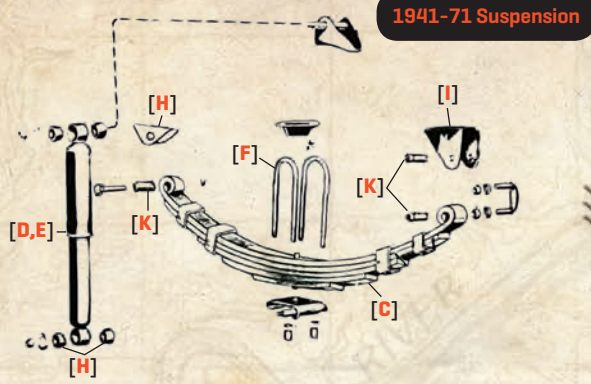

1972-75 Suspension

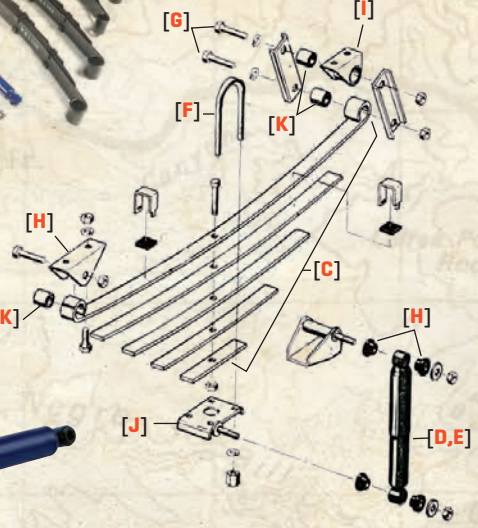

A. Suspension Kits

| | Part# |
|---|----------|
| 1941-1945 MB, 1941-1945 Ford GPW, 1945-1949 CJ2A, 1948-1953 CJ3A, 1950-1952 M38, 1953-1967 CJ3B, Master Suspension Kit NEW | 18290.01 |
| Leaf Spring Kit M38A1 NEW | 18290.07 |
| 1955-1958 CJ5, 1955-1958 CJ6, Master Suspension Kit NEW | 18290.02 |
| 1959-1975 CJ5, 1959-1975 CJ6, Master Suspension Kit NEW | 18290.03 |
| 1976-1981 CJ5, 1976-1981 CJ7, 1981 CJ8, Master Suspension Kit NEW | 18290.04 |
| 1982-1983 CJ5, 1982-1986 CJ7, 1982-1986 CJ8, Master Suspension Kit NEW | 18290.05 |
| 1987-1995 Wrangler, Master Suspension Kit NEW | 18290.06 |

B. Ball Joints

| | Part# |
|--|----------|
| 1972-1983 CJ5, 1972-1975 CJ6, 1976-1986 CJ7, 1981-1986 CJ8, 1974-1991 Cherokee / Grand Wagoneer [SJ], Ball Joint Kit, Includes: 1 Upper & 1 Lower Ball Joint, LH or RH | 18036.01 |
| 1972-1983 CJ5, 1972-1975 CJ6, 1976-1986 CJ7, 1981-1986 CJ8, 1974-1991 Cherokee / Grand Wagoneer [SJ], Upper Ball Joint, LH or RH | 18037.01 |
| 1972-1983 CJ5, 1972-1975 CJ6, 1976-1986 CJ7, 1981-1986 CJ8, 1974-1991 Cherokee / Grand Wagoneer [SJ], Lower Ball Joint, LH or RH | 18038.01 |
| 1984-2001 Cherokee, 1987-2006 Wrangler, 1993-1998 Grand Cherokee, Ball Joint Kit, Includes: 1 Upper & 1 Lower Ball Joint, LH or RH | 18036.02 |
| 1984-2001 Cherokee, 1987-2006 Wrangler, 1993-1998 Grand Cherokee, Ball Joint Kit, Includes: 1 Upper & 1 Lower Ball Joint, LH or RH, Spicer Brand | 18036.03 |
| 1984-2001 Cherokee, 1987-2006 Wrangler, 1993-1998 Grand Cherokee, Lower Ball Joint, LH or RH | 18038.02 |
| 1984-2001 Cherokee, 1987-2006 Wrangler, 1993-1998 Grand Cherokee, Upper Ball Joint, LH or RH | 18037.02 |
| 1999-2004 Grand Cherokee, Ball Joint Kit [Front], Includes: 1 Upper & 1 Lower Ball Joint, LH or RH, Spicer Brand | 18036.04 |
| 2002-2007 Liberty, Lower Ball Joint [Front], LH or RH NEW | 18038.03 |
| 2002-2007 Liberty, Upper Ball Joint [Rear] NEW | 18037.03 |
| 2005-2010 Grand Cherokee, Lower Ball Joint [Front] NEW | 18036.07 |
| 2007-2011 Wrangler, Ball Joint Kit [Dana 30 or 44, Front, Includes: 1 Upper and 1 Lower (Does one side) NEW | 18036.05 |
| 1972-1983 CJ5, 1972-1975 CJ6, 1976-1986 CJ7, 1981-1986 CJ8, 1974-1991 Cherokee / Grand Wagoneer [SJ], Ball Joint Spanner Wrench | 18039.01 |

C. 1941-1975 Military & CJ Leaf Springs

| | Part# |
|--|----------|
| 1941-1945 MB, 1941-1945 Ford GPW, 1945-1949 CJ2A, 1948-1953 CJ3A, 1950-1952 M38, 1953-1967 CJ3B, 1946-1964 Truck, 1946-1964 Station Wagon, Leaf Spring, Front, 8 Leaf | 18201.01 |
| 1941-1945 MB, 1941-1945 Ford GPW, 1945-1949 CJ2A, 1948-1953 CJ3A, 1950-1952 M38, 1953-1967 CJ3B, 1946-1964 Truck, 1946-1964 Station Wagon, Leaf Spring, Rear, 9 Leaf | 18202.01 |
| 1941-1945 MB, 1941-1945 Ford GPW, 1945-1949 CJ2A, 1948-1953 CJ3A, 1950-1952 M38, 1953-1967 CJ3B, 1946-1964 Truck, 1946-1964 Station Wagon, Leaf Spring, Front, 10 Leaf | 18201.02 |
| 1952-1971 M38A1, 1955-1975 CJ5, 1955-1975 CJ6, Leaf Spring, Front, 5 Leaf | 18201.05 |
| 1952-1971 M38A1, 1955-1975 CJ5, 1955-1975 CJ6, Leaf Spring, Front, 7 Leaf | 18201.03 |
| 1952-1971 M38A1, 1955-1975 CJ5, 1955-1975 CJ6, Leaf Spring, Front, 9 Leaf | 18202.02 |
| 1952-1971 M38A1, 1955-1975 CJ5, 1955-1975 CJ6, Leaf Spring, Front, 10 Leaf | 18201.04 |
| 1952-1971 M38A1, 1955-1975 CJ5, 1955-1975 CJ6, Leaf Spring, Rear, 5 Leaf | 18202.05 |
| 1946-1964 Truck, 1946-1964 Station Wagon, Leaf Spring, Rear, 9 Leaf | 18202.04 |
| 1946-1964 Truck, 1946-1964 Station Wagon, Leaf Spring, Rear, 11 Leaf | 18202.03 |

[B] 18038.03

[D, E] 18203.06

D. 1941-1975 Military & CJ Front Shocks

| | Part# |
|---|----------|
| 1941-1945 MB, 1941-1945 Ford GPW, 1945-1949 CJ2A, 1946-1964 Truck, 1946-1964 Station Wagon, 1948-1953 CJ3A, 1950-1952 M38, 1952-1971 M38A1, 1953-1967 CJ3B, 1955-1975 CJ5, 1955-1975 CJ6, Shock Absorber, Front, Gas, Monroe Mono-Matic | 18203.01 |
| 1941-1945 MB, 1941-1945 Ford GPW, 1945-1949 CJ2A, 1946-1964 Truck, 1946-1964 Station Wagon, 1948-1953 CJ3A, 1950-1952 M38, 1952-1971 M38A1, 1953-1967 CJ3B, 1955-1975 CJ5, 1955-1975 CJ6, Shock Absorber, Front, Hydraulic | 18203.02 |

E. 1941-1975 Military & CJ Rear Shocks

| | Part# |
|---|----------|
| 1941-1945 MB, 1941-1945 Ford GPW, 1945-1949 CJ2A, 1948-1953 CJ3A, 1950-1952 M38, Shock Absorber, Rear, Gas, Monroe Mono-Matic | 18203.01 |
| 1941-1945 MB, 1941-1945 Ford GPW, 1945-1949 CJ2A, 1948-1953 CJ3A, 1950-1952 M38, Shock Absorber, Rear, Hydraulic | 18203.02 |
| 1952-1971 M38A1, 1953-1967 CJ3B, 1955-1975 CJ5, 1955-1975 CJ6, Shock Absorber, Front, Gas, Monroe Mono-Matic | 18203.04 |
| 1952-1971 M38A1, 1953-1967 CJ3B, 1955-1975 CJ5, 1955-1975 CJ6, Shock Absorber, Front, Hydraulic | 18203.05 |
| 1946-1964 Truck, 1946-1964 Station Wagon [Without Planar Suspension], Shock, Rear [Pair], Gas, Monroe Mono-Matic | 18203.06 |
| 1946-1964 Station Wagon [With Planar Suspension], 1948-1951 Jeepster, Shock, Rear [Pair], Gas, Monroe Mono-Matic | 18203.07 |

F. 1941-1975 Military & CJ U-Bolts & Shock Plates

| | Part# |
|--|----------|
| 1941-1945 MB, 1941-1945 Ford GPW, Shock Plate [Rear], LH | 12021.53 |
| 1941-1945 MB, 1941-1945 Ford GPW, 1945-1949 CJ2A, 1948-1953 CJ3A, 1950-1952 M38, 1952-1971 M38A1, 1953-1967 CJ3B, 1955-1971 CJ5, 1955-1971 CJ6, U-Bolt, Front, large [1 Required] | 18204.03 |
| 1941-1945 MB, 1941-1945 Ford GPW, Shock Plate [Rear], RH | 12021.52 |
| 1941-1945 MB, 1941-1945 Ford GPW, 1945-1949 CJ2A, 1948-1953 CJ3A, 1950-1952 M38, 1952-1971 M38A1, 1953-1967 CJ3B, 1955-1971 CJ5, 1955-1971 CJ6, U-Bolt, Front, Small [3 Required] | 18204.04 |
| 1941-1945 MB, 1941-1945 Ford GPW, 1945-1949 CJ2A, 1948-1953 CJ3A, 1953-1967 CJ3B, 1955-1971 CJ5, 1955-1971 CJ6, Shock Absorber, Front, Hydraulic | 18204.01 |
| 1941-1945 MB, 1941-1945 Ford GPW, 1945-1949 CJ2A, 1946-1964 Truck, 1946-1964 Station Wagon, 1948-1953 CJ3A, 1950-1952 M38, 1952-1971 M38A1, 1953-1967 CJ3B, 1955-1971 CJ5, 1955-1971 CJ6, U-Bolt Nut, Front or Rear [Long Style] | 18204.10 |
| 1946-1964 Truck, 1946-1964 Station Wagon, U-Bolt, Front, Large [1 Required] | 18204.11 |
| 1946-1964 Truck, 1946-1964 Station Wagon, U-Bolt, Front, Small [3 Required] | 18204.12 |
| 1946-1964 Truck, 1946-1964 Station Wagon, U-Bolt, Rear [4 Required] | 18204.05 |
| 1950-1952 M38, 1952-1971 M38A1, U-Bolt, Rear [4 Required] | 18204.02 |
| 1972-1975 CJ5, 1972-1975 CJ6, U-Bolt, 2-9/16" ID | 18204.06 |
| 1972-1975 CJ5, 1972-1975 CJ6, U-Bolt, 2-3/4" ID, For Dana 44 | 18204.08 |
| 1972-1975 CJ5, 1972-1975 CJ6, U-Bolt, 3-1/4" ID | 18204.07 |

All images are subject to be representative. More detailed information is available online.

Suspension

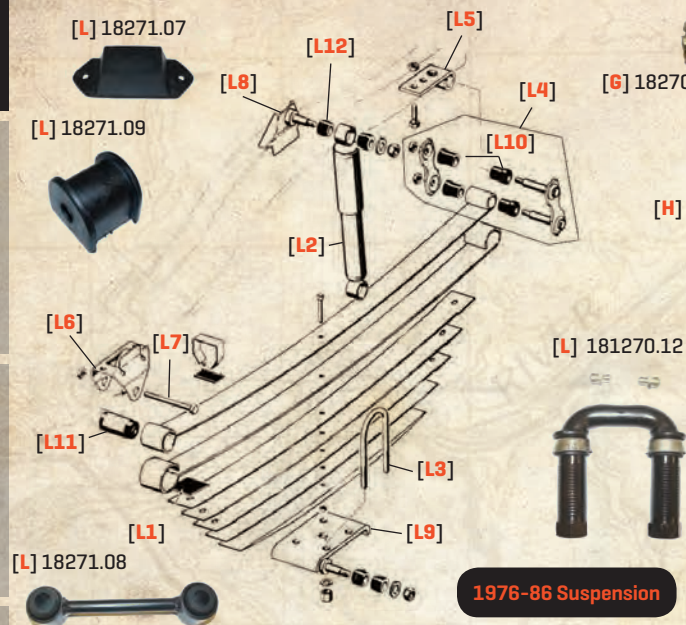

1976-86 Suspension

| G. 1941-1975 Military & CJ Spring Bolts | Part# |
|---|----------|
| 1941-1945 MB, 1941-1945 Ford GPW, 1945-1949 CJ2A, 1948-1953 CJ3A, 1950-1952 M38, 1953-1967 CJ3B, 1946-1964 Truck, 1946-1964 Station Wagon, Leaf Spring Bolt | 18270.01 |

| H. 1941-1975 Military & CJ Pivot Bolts | Part# |
|--|----------|
| 1941-1945 MB, 1941-1945 Ford GPW, Front Torque Reaction Bolt (Medium), Torque Spring to Shackle | 18270.24 |
| 1941-1945 MB, 1941-1945 Ford GPW, Front Torque Reaction Bolt (Long), Leaf Spring to Shackle | 18270.25 |
| 1952-1971 M38A1, 1953-1967 CJ3B, 1955-1966 CJ5, 1955-1966 CJ6, Pivot Bolt | 18270.02 |
| 1941-1945 MB, 1941-1945 Ford GPW, 1945-1949 CJ2A, 1948-1953 CJ3A, 1950-1952 M38, 1952-1971 M38A1, 1953-1967 CJ3B, 1955-1958 CJ5, 1955-1958 CJ6, Pivot Bracket, Spring to Frame, (4 Required) | 18270.05 |
| 1950-71 M38 & M38A1, Pivot Bracket | 18270.05 |
| 1959-1972 CJ5, 1959-1972 CJ6, Pivot Bracket, Spring to Frame, Front or Rear | 18270.06 |

| I. 1941-1975 Military & CJ Shackle Brackets | Part# |
|---|----------|
| 1941-1945 MB, 1941-1945 Ford GPW, 1945-1949 CJ2A, 1948-1953 CJ3A, 1950-1952 M38, 1952-1971 M38A1, 1953-1967 CJ3B, 1955-1958 CJ5, 1955-1958 CJ6, Shackle Bracket, Spring to Frame, Front or Rear | 18270.03 |
| 1959-1975 CJ5, 1959-1975 CJ6, Shackle Bracket, Spring to Frame, Front or Rear | 18270.04 |

| J. 1941-1975 Military & CJ Spring Plates | Part# |
|---|----------|
| 1952-1971 M38A1, 1955-1971 CJ5, 1955-1971 CJ6, Lower Shock Mount Plate, Front, LH | 18270.07 |
| 1952-1971 M38A1, 1955-1971 CJ5, 1955-1971 CJ6, Lower Shock Mount Plate, Front, RH | 18270.08 |
| 1952-1971 M38A1, 1955-1971 CJ5, 1955-1971 CJ6, Lower Shock Mount Plate, Rear, RH | 18270.09 |
| 1952-1971 M38A1, 1955-1971 CJ5, 1955-1971 CJ6, Lower Shock Mount Plate, Rear, LH | 18270.10 |

| K. 1941-1975 Military & CJ Leaf Spring Bushings | Part# |
|--|----------|
| 1941-1945 MB, 1941-1945 Ford GPW, 1945-1949 CJ2A, 1946-1964 Truck, 1946-1964 Station Wagon, 1948-1951 Jeepster, 1948-1953 CJ3A, 1950-1952 M38, 1952-1971 M38A1, 1953-1967 CJ3B, 1955-1971 CJ5, 1955-1971 CJ6, Axle Snubber, (4 Required) | 18270.11 |
| 1941-1945 MB, 1941-1945 Ford GPW, 1945-1949 CJ2A, 1948-1953 CJ3A, 1950-1952 M38, 1952-1971 M38A1, 1953-1967 CJ3B, 1955-1958 CJ5, 1955-1958 CJ6, Pivot Eye Bushing (4 Required) | 18270.17 |
| 1941-1945 MB, 1941-1945 Ford GPW, Front Torque Reaction Bushing | 18270.26 |
| 1946-1964 Truck, 1946-1964 Station Wagon, Pivot Bushing (4 Required) | 18270.27 |
| 1950-71 M38, M38A1, Front Leaf Spring Front Or Rear Eye (2 per eye) | 18270.19 |
| 1952-1971 M38A1, 1953-1967 CJ3B, 1955-1975 CJ5, 1955-1975 CJ6, Leaf Spring Eye Bushing, Front or Rear | 18270.18 |

| L. 1976-1986 CJ Suspension Components | Part# |
|--|----------|
| 1941-1945 MB, 1941-1945 Ford GPW, 1945-1949 CJ2A, 1948-1953 CJ3A, 1950-1952 M38, 1952-1971 M38A1, 1953-1967 CJ3B, 1955-1958 CJ5, 1955-1958 CJ6, Shackle, LH Thread | 18270.12 |
| 1941-1945 MB, 1941-1945 Ford GPW, 1945-1949 CJ2A, 1948-1953 CJ3A, 1950-1952 M38, 1952-1971 M38A1, 1953-1967 CJ3B, 1955-1958 CJ5, 1955-1958 CJ6, Shackle, RH Thread | 18270.13 |
| 1953-71 M381 Shackle Kit (right hand shackle thread) | 18270.14 |
| 1959-1975 CJ5, 1959-1975 CJ6, Shackle Kit, Front or Rear | 18270.15 |
| 1959-1975 CJ5, 1959-1975 CJ6, Shackle Kit, Front or Rear, Heavy Duty (Greaseable) | 18270.16 |
| 1976-1983 CJ5, 1976-1986 CJ7, 1981-1986 CJ8, Leaf Spring, Front, 5 Leaf | 18201.10 |
| 1976-1983 CJ5, 1976-1986 CJ7, 1981-1986 CJ8, Leaf Spring, Front, 6 Leaf | 18201.11 |
| 1976-1983 CJ5, 1976-1986 CJ7, 1981-1986 CJ8, Leaf Spring, Front, 8 Leaf | 18201.12 |
| 1976-1983 CJ5, 1976-1986 CJ7, 1981-1986 CJ8, Leaf Spring, Rear, 4 Leaf | 18202.10 |
| 1976-1983 CJ5, 1976-1986 CJ7, 1981-1986 CJ8, Leaf Spring, Rear 6 Leaf | 18202.11 |
| 1976-1981 CJ5, 1976-1981 CJ7, 1981 CJ8, Shock Absorber, Front, Gas, Monroe Mono-Matic | 18203.01 |
| 1976-1981 CJ5, 1976-1981 CJ7, 1981 CJ8, Shock Absorber, Front, Hydraulic | 18203.02 |
| 1982-1983 CJ5, 1982-1986 CJ7, 1982-1986 CJ8, Shock Absorber, Front, Gas, Monroe Mono-Matic | 18203.08 |
| 1982-1983 CJ5, 1982-1986 CJ7, 1982-1986 CJ8, Shock Absorber, Front, Hydraulic | 18203.09 |
| 1976-1983 CJ5, 1976-1986 CJ7, 1981-1986 CJ8, Shock Absorber, Front, Gas, Monroe Mono-Matic | 18203.04 |
| 1976-1983 CJ5, 1976-1986 CJ7, 1981-1986 CJ8, Shock Absorber, Front, Hydraulic | 18203.05 |
| 1976-1983 CJ5, 1976-1986 CJ7, 1981-1986 CJ8, U-Bolt, 2-9/16" ID | 18204.06 |
| 1976-1983 CJ5, 1976-1986 CJ7, 1981-1986 CJ8, U-Bolt, 3-1/4" ID | 18204.07 |
| 1976-1983 CJ5, 1976-1986 CJ7, 1981-1986 CJ8, U-Bolt, 2-3/4" ID, For Dana 44 | 18204.08 |
| 1976-1983 CJ5, 1976-1986 CJ7, 1981-1986 CJ8, Shackle Kit, Front, With Bushings | 18271.01 |
| 1976-1983 CJ5, 1976-1986 CJ7, 1981-1986 CJ8, Shackle Kit, Rear, With Bushings | 18271.02 |
| 1976-1983 CJ5, 1976-1986 CJ7, 1981-1986 CJ8, Shackle End Spring Hanger, Rear | 18271.03 |
| 1976-1983 CJ5, 1976-1986 CJ7, 1981-1986 CJ8, Shackle End Spring Hanger, Front | 18271.04 |
| 1976-1983 CJ5, 1976-1986 CJ7, 1981-1986 CJ8, Main Eye Spring Hanger, Front or Rear | 18271.05 |
| 1976-1983 CJ5, 1976-1986 CJ7, 1981-1986 CJ8, Leaf Spring Eye Bolt, Front or Rear | 18271.06 |
| 1976-1983 CJ5, 1976-1986 CJ7, 1981-1986 CJ8, Axle Snubber, Front or Rear | 18271.07 |
| 1976-1983 CJ5, 1976-1986 CJ7, 1981-1986 CJ8, Sway Bar End Link, Front With Bushing (2 Required) | 18271.08 |
| 1976-1983 CJ5, 1976-1986 CJ7, 1981-1986 CJ8, Sway Bar Bushing, Front (7/8") | 18271.09 |
| 1976-1981 CJ5, 1976-1981 CJ7, 1981 CJ8, Shock Mount Bracket, Front With Narrow track Axle | 18271.10 |
| 1976-1983 CJ5, 1976-1986 CJ7, 1981-1986 CJ8, Leaf Spring Mounting Kit, Rear For AMC 20 or Dana 44 | 18271.11 |
| 1976-1983 CJ5, 1976-1986 CJ7, 1981-1986 CJ8, Spring Plate (Rear), LH | 18271.12 |
| 1976-1983 CJ5, 1976-1986 CJ7, 1981-1986 CJ8, Leaf Spring Mounting Kit, Front | 18271.13 |
| 1976-1983 CJ5, 1976-1986 CJ7, 1981-1986 CJ8, Spring Plate (Rear), RH | 18271.14 |
| 1976-1983 CJ5, 1976-1986 CJ7, 1981-1986 CJ8, Spring Plate (Front), LH | 18271.15 |
| 1976-1983 CJ5, 1976-1986 CJ7, 1981-1986 CJ8, Spring Plate (Front), RH | 18271.16 |
| 1976-1983 CJ5, 1976-1986 CJ7, 1981-1986 CJ8, Leaf Spring Eye Bushing (Front), Front Position (4 Required) | 18271.17 |
| 1976-1983 CJ5, 1976-1986 CJ7, 1981-1986 CJ8, Leaf Spring Eye Bushing (Front), Rear Position (2 Required) | 18271.19 |
| 1976-1983 CJ5, 1976-1986 CJ7, 1981-1986 CJ8, Leaf Spring Eye Bushing (Rear), Front Position (2 Required) | 18271.18 |
| 1976-1983 CJ5, 1976-1986 CJ7, 1981-1986 CJ8, Leaf Spring Eye Bushing (Rear), Rear Position (4 Required) | 18271.20 |
| 1976-1983 CJ5, 1976-1986 CJ7, 1981-1986 CJ8, Shock Grommet (4 Required Per Shock) | 18270.20 |



| M. 1987-1995 Wrangler Suspension Components | Part# |
|---|----------|
| 1987-1995 Wrangler, Leaf Spring [Front], 4 Leaf | 18201.20 |
| 1987-1995 Wrangler, Leaf Spring [Rear], 5 Leaf | 18201.23 |
| 1987-1995 Wrangler, Leaf Spring [Rear], 6 Leaf | 18202.22 |
| 1987-1995 Wrangler, Shock Absorber, Front, Gas, Monroe Monro-Matic | 18203.20 |
| 1987-1995 Wrangler, Shock Absorber, Front, Gas | 18203.21 |
| 1987-1995 Wrangler, Shock Absorber, Rear, Gas, Monroe Monro-Matic | 18203.22 |
| 1987-1995 Wrangler, Shock Absorber, Rear, Gas | 18203.23 |
| 1987-1995 Wrangler, U-Bolt [2-9/16"] | 18204.06 |
| 1987-1995 Wrangler, U-Bolt 2-3/4" | 18204.08 |
| 1987-1995 Wrangler, U-Bolt [3-1/4"] | 18204.07 |
| 1987-1995 Wrangler, Leaf Spring Main Eye Bolt, Front Or Rear | 18271.06 |
| 1987-1995 Wrangler, Bushing Spacer, Front or Rear | 18272.01 |
| 1987-1995 Wrangler, Leaf Spring Eye Bushing [Front], Front Position [4 Required] | 18272.02 |
| 1987-1995 Wrangler, Leaf Spring Eye Bushing [Front], Rear Position [2 Required] | 18271.19 |
| 1987-1995 Wrangler, Leaf Spring Eye Bushing [Front], Rear Position [2 Required], Clevis Brand | 18207.08 |
| 1987-1995 Wrangler, Leaf Spring Eye Bushing [Rear], Front Position [2 Required] | 18271.19 |
| 1987-1995 Wrangler, Leaf Spring Eye Bushing [Rear], Front Position [2 Required], Clevis Brand | 18207.08 |
| 1987-1995 Wrangler, Leaf Spring Eye Bushing [Rear], Rear Position [4 Required] | 18272.02 |
| 1987-1995 Wrangler, Track Bar [Front] | 18205.01 |
| 1987-1995 Wrangler, Track Bar [Rear] | 18205.02 |
| 1987-1995 Wrangler, Sway Bar Cushion [Front] | 18272.03 |
| 1987-1995 Wrangler, Axle Snubber [Front] | 18272.04 |
| 1987-1995 Wrangler, Axle Snubber [Rear] | 18272.05 |
| 1987-1995 Wrangler, Shackle Plate, Front or rear [8 Required] | 18272.08 |
| 1987-1995 Wrangler, Lower Spring Plate, Front, RH | 18272.09 |
| 1987-1995 Wrangler, Lower Spring Plate, Front, LH | 18272.11 |
| 1987-1995 Wrangler, Lower Spring Plate, Rear, LH | 18272.10 |
| 1987-1995 Wrangler, Lower Spring Plate, Rear, RH | 18272.12 |
| 1987-1995 Wrangler, Shock Grommet | 18272.13 |
| 1987-1995 Wrangler, Suspension Spring Bumper NEW | 18272.15 |

| N. 1997-2011 Wrangler Suspension Components | Part# |
|--|----------|
| 1997-2006 Wrangler, Shock Absorber, Front, Gas, Monroe Monro-Matic | 18203.30 |
| 1997-2006 Wrangler, Shock Absorber, Front, Gas | 18203.31 |
| 1997-2006 Wrangler, Shock Absorber, Rear, Gas, Monroe Monro-Matic | 18203.32 |
| 1997-2006 Wrangler, Shock Absorber, Rear, Gas | 18203.33 |
| 1997-2006 Wrangler, Coil Spring, Front, Each | 18274.01 |
| 1997-2006 Wrangler, Coil Spring, Rear, Each | 18274.02 |
| 1997-2006 Wrangler, Upper Control Arm [Front] | 18280.01 |
| 1997-2006 Wrangler, Upper Control Arm [Rear] | 18282.04 |
| 1997-2006 Wrangler, Lower Control Arm Mount [Front], Heavy Duty | 18273.01 |
| 2007-2011 Wrangler, Shock Absorber, Front NEW | 18203.24 |
| 2007-2011 Wrangler, Shock Absorber, Rear NEW | 18203.25 |
| 1997-2006 Wrangler, Lower Control Arm [Front] NEW | 18282.23 |
| 2007-2011 Wrangler, Lower Control Arm [Front] NEW | 18285.11 |
| 2007-2011 Wrangler, Upper Control Arm [Front] NEW | 18285.10 |
| 2007-2011 Wrangler, Upper Control Arm [Rear] NEW | 18285.12 |

| O. 1984-2001 Cherokee Suspension Components | Part# |
|---|----------|
| 1984-1990 Cherokee, Shock Absorber, Front | 18203.50 |
| 1991-2001 Cherokee, Shock Absorber, Front | 18203.51 |
| 1984-2001 Cherokee, Shock Absorber, Rear | 18203.52 |
| 1984-2001 Cherokee, Shock Grommet | 18272.13 |
| 1991-2001 Cherokee, Upper Control Arm [Front] | 18280.01 |
| 1984-1990 Cherokee, Upper Control Arm Bushing [Front] | 18280.03 |
| 1984-1990 Cherokee, Upper Control Arm Bushing [Front], Clevis Brand | 18207.01 |
| 1991-2001 Cherokee, Upper Control Arm Bushing [Front] | 18280.04 |
| 1991-2001 Cherokee, Upper Control Arm Bushing [Front], Clevis Brand | 18207.03 |
| 1984-2001 Cherokee, Lower Control Arm [Front] | 18280.05 |
| 1984-2001 Cherokee, Lower Control Arm Bushing [Front] | 18280.06 |
| 1984-2001 Cherokee, Lower Control Arm Bushing [Front], Clevis Brand | 18207.02 |
| 1984-2001 Cherokee, Leaf Spring Front Eye Bushing | 18280.07 |
| 1984-2001 Cherokee, Leaf Spring Rear Eye Bushing | 18280.08 |
| 1984-2001 Cherokee, Axle Bumper [Rear] | 18280.09 |
| 1984-2001 Cherokee, Sway Bar Cushion [Rear] | 18280.10 |
| 1991-2001 Cherokee, Sway Bar Link [Front], LH or RH | 18280.11 |
| 1991-2001 Cherokee, Sway Bar Link Bushing [Front], LH or RH | 18280.12 |
| 1984-1990 Cherokee, Track Bar [Front], With Bushings | 18205.03 |
| 1991-2001 Cherokee, Track Bar [Front], With Bushings | 18205.04 |
| 1984-1990 Cherokee, Adjustable Track Bar [Front], With Bushings | 18205.05 |
| 1984-2001 Cherokee, Coil Spring, Front, Each | 18280.13 |
| 1984-1989 Cherokee, Stabilizer Bushing [Front], Orange 20mm | 18280.14 |
| 1990-1996 Cherokee, Stabilizer Bushing [Front], Brown 20mm | 18280.15 |
| 1984-2001 Cherokee, Coil Spring Isolator, Front, Each | 18205.16 |
| 1984-2001 Cherokee, Leaf Spring, Rear, Each | 18280.17 |
| 1984-2001 Cherokee, Coil Spring Cushion, Front, LH or RH | 18280.18 |
| 1984-2001 Cherokee, Sway Bar Bushing, Front, LH or RH | 18280.10 |

All images are subject to be representative. More detailed information is available online.



P. 1993-1998 Grand Cherokee Suspension Components

| Part# | Component |
|----------|--|
| 18203.60 | 1993-1998 Grand Cherokee, Shock Absorber, Front * |
| 18203.61 | 1993-1998 Grand Cherokee, Shock Absorber, Front (With Up Country Option) |
| 18203.62 | 1993-1998 Grand Cherokee, Shock Absorber, Rear * |
| 18203.63 | 1993-1998 Grand Cherokee, Shock Absorber, Rear (With Up Country Option) |
| 18280.02 | 1993-1998 Grand Cherokee, Upper Control Arm (Front) |
| 18282.01 | 1993-1998 Grand Cherokee, Upper Control Arm Bushing (Front) |
| 18280.05 | 1993-1998 Grand Cherokee, Lower Control Arm (Front) |
| 18282.02 | 1993-1998 Grand Cherokee, Lower Control Arm Bushing (Front), Front Position |
| 18207.04 | 1993-1998 Grand Cherokee, Lower Control Arm Bushing (Front), Front Position, Clevite Brand |
| 18282.03 | 1993-1998 Grand Cherokee, Lower Control Arm Bushing (Front), Rear Position |
| 18207.07 | 1993-1998 Grand Cherokee, Lower Control Arm Bushing (Front), Rear Position, Clevite Brand |
| 18282.04 | 1993-1998 Grand Cherokee, Upper Control Arm (Rear) |
| 18282.05 | 1993-1998 Grand Cherokee, Upper Control Arm Bushing (Rear) |
| 18207.05 | 1993-1998 Grand Cherokee, Upper Control Arm Bushing (Rear), Clevite Brand |
| 18282.06 | 1993-1998 Grand Cherokee, Lower Control Arm (Rear) |
| 18282.07 | 1993-1998 Grand Cherokee, Lower Control Arm Bushing (Rear) |
| 18207.06 | 1993-1998 Grand Cherokee, Lower Control Arm Bushing (Rear), Clevite brand |
| 18280.11 | 1993-1996 Grand Cherokee, Sway Bar End Link (Front), LH or RH |
| 18282.08 | 1997-1998 Grand Cherokee, Sway Bar End Link (Front), LH or RH |
| 18280.12 | 1993-1998 Grand Cherokee, Sway Bar End Link Bushing (Front), LH or RH |
| 18205.04 | 1993-1998 Grand Cherokee, Track Bar (Front) |
| 18205.05 | 1993-1998 Grand Cherokee, Adjustable Track Bar (Front) |
| 18282.10 | 1993-1998 Grand Cherokee, Coil Spring (Front), Each |
| 18282.11 | 1993-1998 Grand Cherokee, Coil Spring (Rear), Each |

Q. 1999-2010 Grand Cherokee Suspension Components

| Part# | Component |
|----------|---|
| 18203.67 | 1999-2004 Grand Cherokee, Shock Absorber, Front |
| 18203.68 | 1999-2004 Grand Cherokee, Shock Absorber, Rear |
| 18205.06 | 1999-2004 Grand Cherokee, Track Bar (Front) |
| 18283.01 | 1999-2004 Grand Cherokee, Coil Spring (Front), Each |
| 18283.02 | 1999-2004 Grand Cherokee, Coil Spring (Rear), Each |
| 18283.03 | 1999-2004 Grand Cherokee, Sway Bar End Link (Front), LH or RH |
| 18233.04 | 1999-2004 Grand Cherokee, Sway Bar End Link (Rear), LH or RH |
| 18283.09 | 1999-2004 Grand Cherokee, Sway Bar Bushing (Front), LH or RH |
| 18283.08 | 1999-2004 Grand Cherokee, Sway Bar Bushing (Rear), LH or RH |
| 18283.05 | 1999-2004 Grand Cherokee, Upper Control Arm Bushing (Rear) |
| 18283.06 | 1999-2004 Grand Cherokee, Lower Control Arm Bushing (Front or Rear) |
| 18283.07 | 1999-2004 Grand Cherokee, Upper Control Arm Bushing (Front) |
| 18283.05 | 2002-2007 Liberty, Upper Control Arm Bushing (Rear) |
| 18037.04 | 1999-2004 Grand Cherokee, Upper Ball Joint (Rear) NEW |
| 18203.26 | 2005-2010 Grand Cherokee, Shock Absorber, Front NEW |
| 18203.27 | 2005-2010 Grand Cherokee, Shock Absorber, Rear NEW |
| 18282.20 | 1999-2004 Grand Cherokee, Upper Control Arm (Front) NEW |
| 18282.21 | 1999-2004 Grand Cherokee, Lower Control Arm (Front) NEW |
| 18282.22 | 1999-2004 Grand Cherokee, Lower Control Arm (Rear) NEW |
| 18282.24 | 2005-2010 Grand Cherokee, Upper Control Arm (Front) NEW |
| 18282.25 | 1999-2004 Grand Cherokee, Upper Control Arm (Rear) NEW |
| 18282.26 | 2005-2010 Grand Cherokee, Lower Control Arm (Front), RH NEW |
| 18282.27 | 2005-2010 Grand Cherokee, Lower Control Arm (Front), LH NEW |
| 18283.04 | 1999-2004 Grand Cherokee, Sway Bar End Link (Rear), LH or RH NEW |

| Part# | Component |
|----------|--------------|
| 18283.01 | [Q] 18283.01 |
| 18203.53 | [R] 18203.53 |
| 18265.12 | [T] 18265.12 |
| 18284.02 | [U] 18284.02 |
| 18206.01 | [S] 18206.01 |

R. 2002-2007 Liberty Suspension Components

| Part# | Component |
|----------|---|
| 18203.53 | 2002-2007 Liberty, Shock Absorber (Strut), Front NEW |
| 18203.54 | 2002-2007 Liberty, Shock Absorber, Rear NEW |
| 18283.10 | 2002-2003 Liberty, Lower Control Arm Bushing (Rear), Body To Control Arm NEW |
| 18283.11 | 2002-2003 Liberty, Lower Control Arm Bushing (Rear), Control Arm To Axle NEW |
| 18283.12 | 2004-2007 Liberty, Lower Control Arm Bushing (Rear), Body To Control Arm NEW |
| 18283.13 | 2004-2007 Liberty, Lower Control Arm Bushing (Rear), Control Arm To Axle NEW |

S. Degree Wedges

| Part# | Component |
|----------|--|
| 18206.01 | 1976-1983 CJ5, 1976-1986 CJ7, 1981-1986 CJ8, 1987-1995 Wrangler, Pinion Angle Shims [6°], Aluminum |
| 18206.02 | 1976-1983 CJ5, 1976-1986 CJ7, 1981-1986 CJ8, 1987-1995 Wrangler, Pinion Angle Shims [8°], Aluminum |

T. Heavy Duty Shackle Kits

| Part# | Component |
|----------|---|
| 18265.01 | 1959-1975 CJ5, 1959-1975 CJ6, Shackle Kit, Without Bushings, Front or Rear, Heavy Duty |
| 18265.02 | 1959-1975 CJ5, 1959-1975 CJ6, Shackle Kit, Greasable, Without Bushings, Front or Rear, Heavy Duty |
| 18265.03 | 1959-1975 CJ5, 1959-1975 CJ6, Shackle Kit, Black Bushings, Front or Rear, Heavy Duty |
| 18265.04 | 1959-1975 CJ5, 1959-1975 CJ6, Shackle Kit, Red Bushings, Front or Rear, Heavy Duty |
| 18265.05 | 1976-1983 CJ5, 1976-1986 CJ7, 1981-1986 CJ8, Shackle Kit, Without Bushings, Front, Heavy Duty |
| 18265.09 | 1976-1983 CJ5, 1976-1986 CJ7, 1981-1986 CJ8, Shackle Kit, Without Bushings, Rear, Heavy Duty |
| 18265.06 | 1976-1983 CJ5, 1976-1986 CJ7, 1981-1986 CJ8, Shackle Kit (Greasable), Without Bushings, Front, Heavy Duty |
| 18265.10 | 1976-1983 CJ5, 1976-1986 CJ7, 1981-1986 CJ8, Shackle Kit (Greasable), Without Bushings, Rear, Heavy Duty |
| 18265.07 | 1976-1983 CJ5, 1976-1986 CJ7, 1981-1986 CJ8, Shackle Kit (Greasable), Black Bushings, Front, Heavy Duty |
| 18265.11 | 1976-1983 CJ5, 1976-1986 CJ7, 1981-1986 CJ8, Shackle Kit (Greasable), Black Bushings, Rear, Heavy Duty |
| 18265.08 | 1976-1983 CJ5, 1976-1986 CJ7, 1981-1986 CJ8, Shackle Kit (Greasable), Red Bushings, Front, Heavy Duty |
| 18265.12 | 1976-1983 CJ5, 1976-1986 CJ7, 1981-1986 CJ8, Shackle Kit (Greasable), Red Bushings, Rear, Heavy Duty |
| 18265.13 | 1987-1995 Wrangler, Shackle Kit, Without Bushings, Front, Heavy Duty, Provides 1" Of Lift |
| 18265.17 | 1987-1995 Wrangler, Shackle Kit, Without Bushings, Rear, Heavy Duty, Provides 1" Of Lift |
| 18265.14 | 1987-1995 Wrangler, Shackle Kit (Greasable), Without Bushings, Front, Heavy Duty, Provides 1" Of Lift |
| 18265.18 | 1987-1995 Wrangler, Shackle Kit (Greasable), Without Bushings, Rear, Heavy Duty |
| 18265.15 | 1987-1995 Wrangler, Shackle Kit (Greasable), Black Bushings, Front, Heavy Duty, Provides 1" Of Lift |
| 18265.19 | 1987-1995 Wrangler, Shackle Kit (Greasable), Black Bushings, Rear, Heavy Duty, Provides 1" Of Lift |
| 18265.16 | 1987-1995 Wrangler, Shackle Kit (Greasable), Red Bushings, Front, Heavy Duty, Provides 1" Of Lift |
| 18265.20 | 1987-1995 Wrangler, Shackle Kit (Greasable), Red Bushings, Rear, Heavy Duty, Provides 1" Of Lift |

U. Misc Suspension Components

| Part# | Component |
|----------|--|
| 18284.01 | 1973-74 DJ5C (Postal), King Bolt Set, (Does 1 Side) |
| 18284.02 | 1978-1984 DJ5 (Postal), Spring Bushing |
| 18284.03 | 1974-1991 Cherokee / Grand Wagoneer, Spring Bushing [1-1/2" Od X 2-5/16 & 2-7/8" Long] |
| 18284.04 | 1974-1991 Cherokee / Grand Wagoneer, Spring Bushing [2" Od X 2-15/16" Long] |

* Except Up Country

Transfer Case - Dana 18



A. Dana 18 Transfer Case

Part#

| | | |
|----|---|----------|
| 1 | 1945-1949 CJ2A, 1948-1953 CJ3A, 1950-1952 M38, 1946-1953 Truck, 1946-1953 Station Wagon, Overhaul Repair Kit [Dana 18 Transfer Case], With 1-1/4" Intermediate Shaft | 18601.01 |
| 1 | 1953-1967 CJ3B, 1952-1971 M38A1, 1955-1971 CJ5, 1955-1971 CJ6, 1954-1964 Truck, 1954-1964 Station Wagon, Overhaul Repair Kit [Dana 18 Transfer Case], With 1-1/4" Intermediate Shaft | 18601.02 |
| 2 | 1953-1967 CJ3B, 1952-1971 M38A1, 1955-1971 CJ5, 1955-1971 CJ6, 1954-1964 Truck, 1954-1964 Station Wagon, Dana 18 Transfer Case Assembly, With 1-1/4" Intermediate Shaft, Twin Stick [For 134 Cl] | 18602.01 |
| 3 | 1945-1949 CJ2A, 1948-1953 CJ3A, 1950-1952 M38, 1946-1964 Truck, 1946-1964 Station Wagon, 1953-1967 CJ3B, 1952-1971 M38A1, 1955-1971 CJ5, 1955-1971 CJ6, Gasket Set [Dana 18 Transfer Case] | 18603.01 |
| 5 | 1945-1971 Models, Output Shaft Bearing [Dana 18 Transfer Case] | 18670.01 |
| 6 | 1945-1971 Models, Output Shaft Bearing Snap Ring [Dana 18 Transfer Case] | 18670.02 |
| 7 | 1945-1971 Models, Yoke Felt [Dana 18 Transfer Case], Front or rear [2 Required] | 18670.03 |
| 8 | 1945-1971 Models, Yoke Oil Seal [Dana 18 Transfer Case], Front or rear [2 Required] | 18670.04 |
| 9 | 1945-1971 Models, Rear Output Shaft [Dana 18 Transfer Case] | 18670.05 |
| 10 | 1945-1971 Models, Output Shaft Bearing Cone [Dana 18 Transfer Case], [2 Required] | 18670.06 |
| 11 | 1945-1971 Models, Output Shaft Bearing Cup [Dana 18 Transfer Case], [2 Required] | 18670.07 |
| 12 | 1945-1971 Models, Front Output Shaft Bushing [Dana 18 Transfer Case] | 18670.08 |
| 13 | 1953-1967 CJ3B, 1952-1971 M38A1, 1955-1966 CJ5, 1955-1966 CJ6, 1954-1964 Truck, 1954-1964 Station Wagon, Output Shaft Sliding Gear [Dana 18 Transfer Case], 33 Tooth, [Marked 18-8-22] | 18670.10 |
| 14 | 1953-1967 CJ3B, 1952-1971 M38A1, 1955-1966 CJ5, 1955-1966 CJ6, 1954-1964 Truck, 1954-1964 Station Wagon, Output Shaft Sliding Gear [Dana 18 Transfer Case], 29 Tooth, [Marked 18-8-24] | 18670.12 |
| 15 | 1941-1966 Models, Front Output Shaft Gear Thrust Washer [Dana 18 Transfer Case] | 18670.13 |
| 16 | 1941-1966 Models, Front Output Shaft Gear Snap Ring [Dana 18 Transfer Case] | 18670.14 |
| 17 | 1941-1971 Models, Front Output Shaft Clutch [Dana 18 Transfer Case], 10 Tooth | 18670.15 |
| 18 | 1953-1967 CJ3B, 1952-1971 M38A1, 1955-1966 CJ5, 1955-1966 CJ6, 1954-1964 Truck, 1954-1964 Station Wagon, Intermediate Shaft Gear [Dana 18 Transfer Case], 33 Tooth, [Marked 18-5-9] | 18670.17 |
| 19 | 1941-1945 MB, 1941-1945 Ford GPW, Intermediate Shaft [3/4"] [Dana 18 Transfer Case] | 18604.01 |
| 19 | 1941-1945 MB, 1941-1945 Ford GPW, Intermediate Shaft [1-1/8"] [Dana 18 Transfer Case] | 18604.02 |
| 19 | 1945-1949 CJ2A, 1948-1953 CJ3A, 1950-1952 M38, 1946-1953 Truck, 1946-1953 Station Wagon, Intermediate Shaft [1-1/4"] [Dana 18 Transfer Case] | 18604.03 |

A. Dana 18 Transfer Case (Continued)

Part#

| | | |
|-----|---|----------|
| 19 | 1953-1967 CJ3B, 1952-1971 M38A1, 1955-1971 CJ5, 1955-1971 CJ6, 1954-1964 Truck, 1954-1964 Station Wagon, Intermediate Shaft [1-1/4"] [Dana 18 Transfer Case]Twin Stick [For 134 Cl] | 18604.04 |
| 19A | 1953-1967 CJ3B, 1952-1971 M38A1, 1955-1971 CJ5, 1955-1971 CJ6, 1954-1964 Truck, 1954-1964 Station Wagon, Intermediate Shaft Kit [1-1/8"] [Dana 18 Transfer Case]Twin Stick [For 134 Cl] | 18605.01 |
| 19A | 1945-1949 CJ2A, 1948-1953 CJ3A, 1950-1952 M38, 1946-1953 Truck, 1946-1953 Station Wagon, Intermediate Shaft Kit [1-1/4"] [Dana 18 Transfer Case] | 18605.03 |
| 20 | 1941-1945 MB, 1941-1945 Ford GPW, Intermediate Shaft Roller Cage Bearing [3/4"] [Dana 18 Transfer Case] | 18670.18 |
| 20 | 1945-1949 CJ2A, 1948-1953 CJ3A, 1950-1952 M38, 1946-1964 Truck, 1946-1964 Station Wagon, 1952-1971 M38A1, 1955-1966 CJ5, 1955-1966 CJ6 Intermediate Shaft Roller Cage Bearing [1-1/8"] [Dana 18 Transfer Case] [2 Required] | 18670.19 |
| 20 | 1945-1949 CJ2A, 1948-1953 CJ3A, 1950-1952 M38, 1946-1953 Truck, 1946-1953 Station Wagon, Intermediate Shaft Roller Cage Bearing [1-1/4"] [Dana 18 Transfer Case] [Needle Bearing 48 Required] | 18670.20 |
| 21 | 1945-1949 CJ2A, 1948-1953 CJ3A, 1950-1952 M38, 1946-1953 Truck, 1946-1953 Station Wagon, Intermediate Shaft Roller Cage Bearing Spacer [1-1/4"] [Dana 18 Transfer Case] | 18670.21 |
| 22 | 1941-1945 MB, 1941-1945 Ford GPW, Intermediate Shaft Thrust Washer [3/4"] [Dana 18 Transfer Case] [2 Required] | 18670.22 |
| 22 | 1953-1967 CJ3B, 1952-1971 M38A1, 1955-1971 CJ5, 1955-1971 CJ6, 1954-1964 Truck, 1954-1964 Station Wagon, Intermediate Shaft Thrust Washer [1-1/8"] [Dana 18 Transfer Case] [2 Required] | 18670.23 |
| 22 | 1945-1949 CJ2A, 1948-1953 CJ3A, 1950-1952 M38, 1946-1953 Truck, 1946-1953 Station Wagon, Intermediate Shaft Thrust Washer [1-1/4"] [Dana 18 Transfer Case] [2 Required] | 18670.24 |
| 23 | 1953-1967 CJ3B, 1952-1971 M38A1, 1955-1971 CJ5, 1955-1971 CJ6, 1954-1964 Truck, 1954-1964 Station Wagon, Main Shaft Gear [Dana 18 Transfer Case], 29 Tooth, 6 Spline [Marked 18-8-23] | 18670.25 |
| 24 | 1945-1971 Models, Output Shaft Yoke [Dana 18 Transfer Case], [2 Required] | 16580.01 |
| 25 | 1945-1971 Models, Output Shaft Yoke Companion Flange [Dana 18 Transfer Case] | 18670.27 |
| 26 | 1941-1945 MB, 1941-1945 Ford GPW, 1945-1949 CJ2A, Output Shaft Yoke [Dana 18 Transfer Case], 3/4"-20 Fine Thread [2 Required] NEW | 16584.12 |
| 26 | 1945-1971 Models, Output Shaft Yoke Nut [Dana 18 Transfer Case], [2 Required] | 16584.01 |
| 27 | 1941-1966 Models, Shifter Pivot [Dana 18 Transfer Case] | 18670.29 |
| 28 | 1941-1971 Models, Shifter Rod Oil Seals [Dana 18 Transfer Case], For Twin Stick Shifter [2 Required] | 18670.30 |
| 29 | 1941-1971 Models, Shift Fork [Dana 18 Transfer Case] | 18670.31 |
| 31 | 1941-1971 Models, Shifter Boot [Dana 18 Transfer Case], For Twin Stick Shifter | 18606.01 |
| 32 | 1941-1971 Models, Shifter Knob [Dana 18 Transfer Case], plain Black | 18607.01 |
| 33 | 1941-1971 Models, Transfer Case Mount [Dana 18 Transfer Case] | 18608.01 |
| 34 | 1941-1971 Models, Transfer Case Insulator [Snubber] Kit [Dana 18 Transfer Case] | 18608.15 |

All images are subject to be representative. More detailed information is available online.

Transfer Case - Dana 20 & Borg Warner Quadratrac

Dana 20
1972-1979 CJ

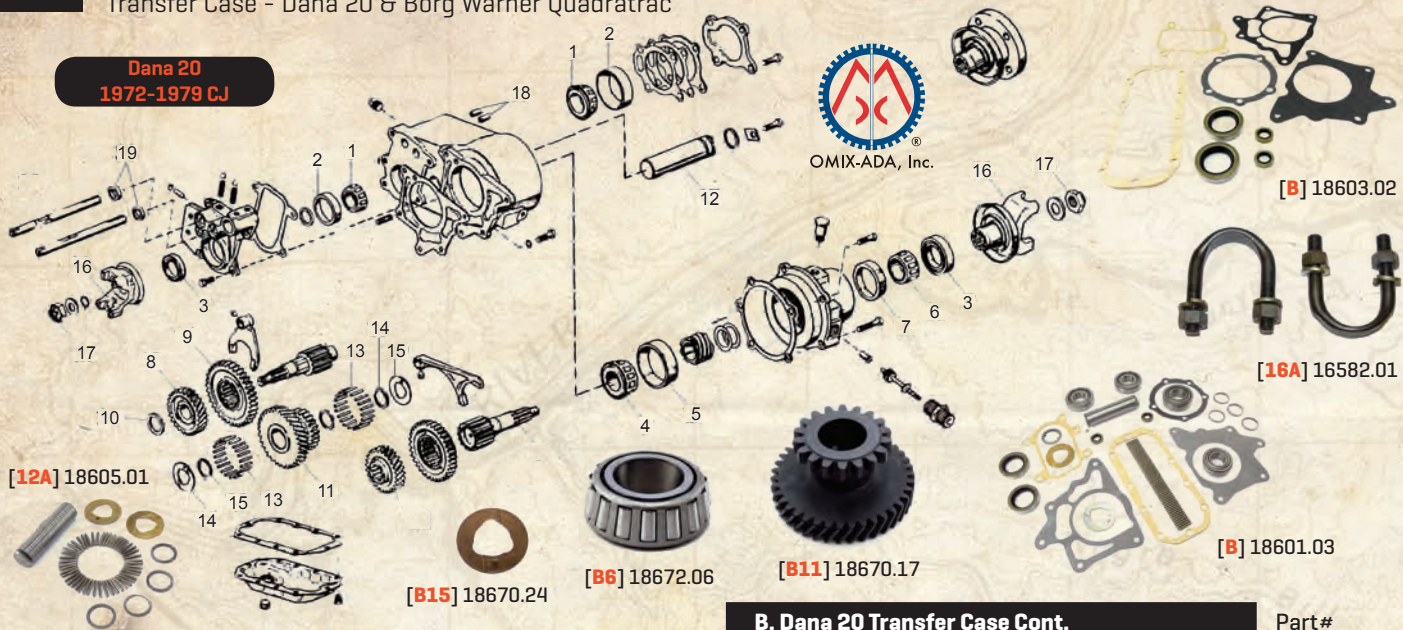

B. Dana 20 Transfer Case

Part#

| | |
|--|----------|
| 1972-1979 CJ5, 1972-1975 CJ6, 1976-1979 CJ7, <i>Overhaul Kit</i> (Dana 20 Transfer Case) | 18601.03 |
| 1972-1979 CJ5, 1972-1975 CJ6, 1976-1979 CJ7, <i>Gasket Set</i> (Dana 300 Transfer Case) | 18603.02 |
| 1972-1979 CJ5, 1972-1975 CJ6, 1976-1979 CJ7, Bearing Cone (Dana 20 Transfer Case), Front Output Shaft [2 Needed] | 18672.02 |
| 1972-1979 CJ5, 1972-1975 CJ6, 1976-1979 CJ7, Bearing Cup (Dana 20 Transfer Case), Front Output Shaft [2 Needed] | 18670.07 |
| 1972-1979 CJ5, 1972-1975 CJ6, 1976-1979 CJ7, Oil Seal (Dana 20 Transfer Case), Front Or Rear Yoke [2 Needed] | 18670.04 |
| 1972-1979 CJ5, 1972-1975 CJ6, 1976-1979 CJ7, Bearing Cone (Dana 20 Transfer Case), Inner Rear Output Shaft | 16536.01 |
| 1972-1979 CJ5, 1972-1975 CJ6, 1976-1979 CJ7, Bearing Cup (Dana 20 Transfer Case), Inner Rear Output Shaft | 16536.02 |
| 1972-1979 CJ5, 1972-1975 CJ6, 1976-1979 CJ7, Bearing Cone (Dana 20 Transfer Case), Outer Rear Output Shaft | 18672.06 |
| 1972-1979 CJ5, 1972-1975 CJ6, 1976-1979 CJ7, Bearing Cup (Dana 20 Transfer Case), Outer Rear Output Shaft | 18672.07 |
| 1972-1979 CJ5, 1972-1975 CJ6, 1976-1979 CJ7, Front Output Shaft Gear (Dana 20 Transfer Case), 29 Teeth Count (Mark 18-8-24 Or 18-8-64) | 18670.12 |
| 1972-1979 CJ5, 1972-1975 CJ6, 1976-1979 CJ7, Output Shaft Sliding Gear (Dana 20 Transfer Case), 31 Teeth Count (Mark 18-8-28) NEW | 18672.09 |
| 1972-1979 CJ5, 1972-1975 CJ6, 1976-1979 CJ7, Output Shaft Sliding Gear (Dana 20 Transfer Case), 33 Teeth Count (Mark 18-8-22) | 18670.10 |
| 1972-1979 CJ5, 1972-1975 CJ6, 1976-1979 CJ7, Thrust Washer (Dana 20 Transfer Case), Front Output Shaft Gear | 18672.10 |
| 1972-1979 CJ5, 1972-1975 CJ6, 1976-1979 CJ7, Intermediate Gear (Dana 20 Transfer Case), 39X18 Teeth Count (Mark 18-5-9) | 18670.17 |
| 1972-1979 CJ5, 1972-1975 CJ6, 1976-1979 CJ7, Intermediate Gear (Dana 20 Transfer Case), 34X20 Teeth Count (Mark 18-5-10) Ltd. Avail. | 18672.11 |
| 1972-1979 CJ5, 1972-1975 CJ6, 1976-1979 CJ7, Intermediate Gear Shaft (Dana 20 Transfer Case) | 18604.03 |
| 1972-1979 CJ5, 1972-1975 CJ6, 1976-1979 CJ7, Intermediate Gear Shaft Kit (Dana 20 Transfer Case) | 18605.01 |
| 1972-1979 CJ5, 1972-1975 CJ6, 1976-1979 CJ7, Needle Roller Bearing (Dana 20 Transfer Case), [48 Required] | 18670.20 |
| 1972-1979 CJ5, 1972-1975 CJ6, 1976-1979 CJ7, Intermediate Gear Shaft Spacer (Dana 20 Transfer Case) | 18670.21 |
| 1972-1979 CJ5, 1972-1975 CJ6, 1976-1979 CJ7, Intermediate Shaft Thrust Washer (Dana 20 Transfer Case) | 18670.24 |
| 1972-1979 CJ5, 1972-1975 CJ6, 1976-1979 CJ7, Output Shaft Yoke (Dana 20 Transfer Case), 10 Spline [2 Required] | 16580.01 |
| 1972-1979 CJ5, 1972-1975 CJ6, 1976-1979 CJ7, Output Shaft Yoke (Dana 20 Transfer Case), 26 Spline, U-Joint Style, [2 Required] | 16580.02 |
| 1972-1979 CJ5, 1972-1975 CJ6, 1976-1979 CJ7, U-Bolt For 16580.02 Yoke (Dana 20 Transfer Case), pair | 16582.01 |
| 1972-1979 CJ5, 1972-1975 CJ6, 1976-1979 CJ7, U-Bolt For 16580.02 Yoke (Dana 20 Transfer Case), Pair, Spicer Brand | 16582.02 |
| 1972-1979 CJ5, 1972-1975 CJ6, 1976-1979 CJ7, Output Shaft Yoke Nut (Dana 20 Transfer Case), [2 Required] | 16584.01 |
| 1972-1979 CJ5, 1972-1975 CJ6, 1976-1979 CJ7, Shift Knob W/ Shift Pattern (Dana 20 Transfer Case) | 18607.02 |
| 1972-1979 CJ5, 1972-1975 CJ6, 1976-1979 CJ7, Shift Rod Cap Cover (Dana 20 Transfer Case) | 18672.17 |
| 1972-1979 CJ5, 1972-1975 CJ6, 1976-1979 CJ7, Shift Rod Oil Seal (Dana 20 Transfer Case), [2 Required] | 18670.30 |

B. Dana 20 Transfer Case Cont.

Part#

| | |
|---|----------|
| 1972-1979 CJ5, 1972-1975 CJ6, 1976-1979 CJ7, Transfer Case Mount (Dana 20 Transfer Case) | 18608.02 |
| 1972-1979 CJ5, 1972-1975 CJ6, 1976-1979 CJ7, Polyurethane Mount (Dana 20 Transfer Case), Red | 18392.01 |
| 1972-1979 CJ5, 1972-1975 CJ6, 1976-1979 CJ7, Polyurethane Mount (Dana 20 Transfer Case), Black | 18608.04 |
| 1972-1979 CJ5, 1972-1975 CJ6, 1976-1979 CJ7, Stabilizer Stud, Transmission Mount (Dana 20 Transfer Case) | 18608.05 |
| 1972-1979 CJ5, 1972-1975 CJ6, 1976-1979 CJ7, Stabilizer Bushing (Dana 20 Transfer Case), [2 Required] | 18608.06 |
| 1972-1979 CJ5, 1972-1975 CJ6, 1976-1979 CJ7, Polyurethane Stabilizer Bushing (Dana 20 Transfer Case), Red, Pair | 18369.01 |
| 1972-1979 CJ5, 1972-1975 CJ6, 1976-1979 CJ7, Polyurethane Stabilizer Bushing (Dana 20 Transfer Case), Black, Pair | 18608.08 |

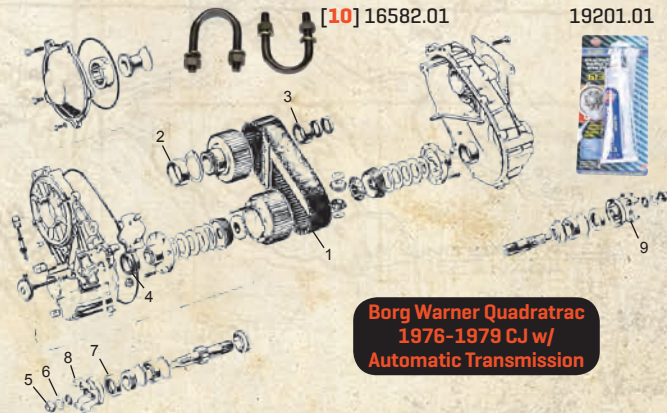

C. Borg Warner Quadratrac Transfer Case

Part#

| | |
|--|----------|
| RTV Silicon [3 oz] | 19201.01 |
| 1976-1979 CJ7, Drive Chain Replacement For Factory Chain (Quadratrac Transfer Case) | 18612.08 |
| 1976-1979 CJ7, Drive Chain Replacement For Overdrive Part-Time Conversion Kit (Quadratrac Transfer Case) | 18612.09 |
| 1976-1979 CJ7, Bearing, Rear Upper Sprocket (Quadratrac Transfer Case) | 18678.02 |
| 1976-1979 CJ7, Bearing, Front Upper Sprocket (Quadratrac Transfer Case) | 18678.03 |
| 1976-1979 CJ7, Bearing, Frt & Rear Lower Sprocket (Quadratrac Transfer Case), [2 Required] | 18678.03 |
| 1976-1979 CJ7, Nut For Front Or Rear Yoke (Quadratrac Transfer Case), [2 Required] | 16584.01 |
| 1976-1979 CJ7, Washer For Front Or Rear Yoke (Quadratrac Transfer Case), [2 Required] | 16584.02 |
| 1976-1979 CJ7, Oil Seal, Front Or Rear Yoke (Quadratrac Transfer Case), [2 Required] | 18670.04 |
| 1976-1979 CJ7, Yoke, Rear Output, 10 Spline (Quadratrac Transfer Case) | 16580.01 |
| 1976-1979 CJ7, Yoke, Front Output, 10 Spline (Quadratrac Transfer Case) | 18678.04 |
| 1976-1979 CJ7, Yoke, Front Output, 26 Spline (Quadratrac Transfer Case) | 18678.05 |
| 1976-1979 CJ7, U-Bolt (Quadratrac Transfer Case), [Use One Pair Per Yoke] | 16582.01 |
| 1976-1979 CJ7, U-Bolt (Quadratrac Transfer Case), [Use One Pair Per Yoke], Spicer Brand | 16582.02 |

Dana 300
Transfer Case
1980-1986 CJ

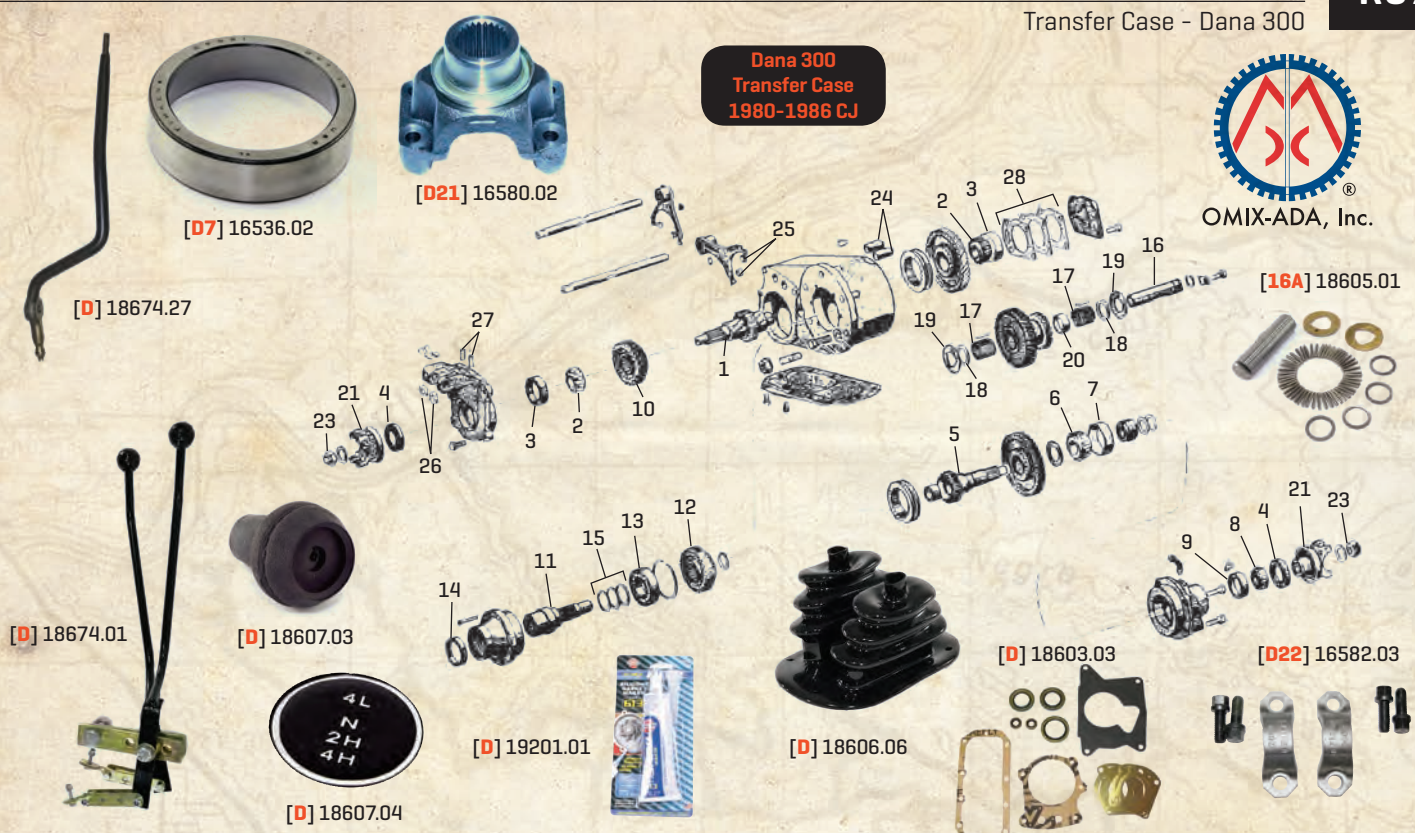

| D. Dana 300 Transfer Case | Part# |
|--|----------|
| 1980-1983 CJ5, 1980-1986 CJ7, 1981-1986 CJ8, Twin Stick Shifter Assembly [Dana 300 Transfer Case] | 18674.01 |
| 1980-1983 CJ5, 1980-1986 CJ7, 1981-1986 CJ8, Shift Knob [Dana 300 Transfer Case] | 18607.03 |
| 1980-1983 CJ5, 1980-1986 CJ7, 1981-1986 CJ8, Shifter Knob Shift Pattern Insert [Dana 300 Transfer Case] | 18607.04 |
| 1980-1983 CJ5, 1980-1986 CJ7, 1981-1986 CJ8, Shifter Lever [Dana 300 Transfer Case] | 18674.27 |
| 1980-1983 CJ5, 1980-1986 CJ7, 1981-1986 CJ8, Shifter Shaft [Dana 300 Transfer Case] | 18674.28 |
| 1980-1983 CJ5, 1980-1986 CJ7, 1981-1986 CJ8, Boot For Twin Stick Shift [Dana 300 Transfer Case] | 18606.06 |
| 1980-1983 CJ5, 1980-1986 CJ7, 1981-1986 CJ8, Gaskets & Oil Seals Kit [Dana 300 Transfer Case] | 18603.03 |
| RTV Silicon [3 oz] | 19201.01 |
| 1 1980-1983 CJ5, 1980-1986 CJ7, 1981-1986 CJ8, Front Output Shaft [Dana 300 Transfer Case], 26 Spline | 18674.08 |
| 2 1980-1983 CJ5, 1980-1986 CJ7, 1981-1986 CJ8, Bearing Cone, Front Output Shaft [Dana 300 Transfer Case], [2 Needed] | 18674.09 |
| 3 1980-1983 CJ5, 1980-1986 CJ7, 1981-1986 CJ8, Bearing Cup, Front Output Shaft [Dana 300 Transfer Case], [2 Needed] | 18674.10 |
| 4 1980-1983 CJ5, 1980-1986 CJ7, 1981-1986 CJ8, Oil Seal, Output Shaft Yoke [Dana 300 Transfer Case], [2 Needed] | 18674.11 |
| 5 1980-1983 CJ5, 1980-1986 CJ7, 1981-1986 CJ8, Rear Output Shaft [Dana 300 Transfer Case] | 18674.12 |
| 6 1980-1983 CJ5, 1980-1986 CJ7, 1981-1986 CJ8, Bearing Cone, Inner Rear Output Shaft | 18674.13 |
| 7 1980-1983 CJ5, 1980-1986 CJ7, 1981-1986 CJ8, Bearing Cup, Inner Rear Output Shaft [Dana 300 Transfer Case] | 16536.02 |
| 8 1980-1983 CJ5, 1980-1986 CJ7, 1981-1986 CJ8, Bearing Cone, Outer Rear Output Shaft [Dana 300 Transfer Case] | 18672.06 |
| 9 1980-1983 CJ5, 1980-1986 CJ7, 1981-1986 CJ8, Bearing Cup, Outer Rear Output Shaft [Dana 300 Transfer Case] | 18672.07 |
| 10 1980-1983 CJ5, 1980-1986 CJ7, 1981-1986 CJ8, Front Output Shaft Gear [Dana 300 Transfer Case] | 18674.14 |
| 11 1980-1983 CJ5, 1980-1986 CJ7, 1981-1986 CJ8, Input Shaft [Dana 300 Transfer Case] | 18674.16 |
| 12 1980-1983 CJ5, 1980-1986 CJ7, 1981-1986 CJ8, Input Shaft Gear [Dana 300 Transfer Case] | 18674.17 |
| 13 1980-1983 CJ5, 1980-1986 CJ7, 1981-1986 CJ8, Input Shaft Bearing [Dana 300 Transfer Case] | 18674.18 |
| 14 1980-1983 CJ5, 1980-1986 CJ7, 1981-1986 CJ8, Input Shaft Oil Seal [Dana 300 Transfer Case] | 18674.19 |
| 15 1980-1983 CJ5, 1980-1986 CJ7, 1981-1986 CJ8, Input Shaft Shim Kit [Dana 300 Transfer Case] | 18674.20 |
| 16 1980-1983 CJ5, 1980-1986 CJ7, 1981-1986 CJ8, Shaft, Intermediate Gear [Dana 300 Transfer Case] | 18604.03 |
| 16A 1980-1983 CJ5, 1980-1986 CJ7, 1981-1986 CJ8, Shaft, Needles & Washer Kit [Dana 300 Transfer Case] | 18605.01 |
| 17 1980-1983 CJ5, 1980-1986 CJ7, 1981-1986 CJ8, Needle Roller Bearing [Dana 300 Transfer Case], [48 Needed] | 18670.20 |

| D. Dana 300 Transfer Case [continued] | Part# |
|--|----------|
| 18 1980-1983 CJ5, 1980-1986 CJ7, 1981-1986 CJ8, Spacer, Intermediate Gear Shaft [Dana 300 Transfer Case], [2 Needed] | 18670.21 |
| 19 1980-1983 CJ5, 1980-1986 CJ7, 1981-1986 CJ8, Thrust Washer, Intermediate Shaft [Dana 300 Transfer Case], [2 Needed] | 18670.24 |
| 20 1980-1983 CJ5, 1980-1986 CJ7, 1981-1986 CJ8, Spacer, Intermediate Shaft Bearing | 18674.22 |
| 21 1980-1983 CJ5, 1980-1986 CJ7, 1981-1986 CJ8, Front Or Rear Yoke [Dana 300 Transfer Case], Strap & Bolt Design [2 Needed] | 16580.03 |
| 21 1980-1983 CJ5, 1980-1986 CJ7, 1981-1986 CJ8, Front Or Rear Yoke [Dana 300 Transfer Case], U Bolt Design [2 Needed] | 16580.02 |
| 22 1980-1983 CJ5, 1980-1986 CJ7, 1981-1986 CJ8, U-Bolt: Strap & Bolt Design [For 16580.03] | 16582.03 |
| 22 1980-1983 CJ5, 1980-1986 CJ7, 1981-1986 CJ8, U-Bolt: U-Bolt Design [Pair, Per Yoke] [For 16580.02] | 16582.01 |
| 22 1980-1983 CJ5, 1980-1986 CJ7, 1981-1986 CJ8, U-Bolt: U-Bolt Design [Pr/Yoke] [For 16580.02] - Spicer | 16582.02 |
| 23 1980-1983 CJ5, 1980-1986 CJ7, 1981-1986 CJ8, Nut For Front Or Rear Yoke [2 Needed] | 16584.01 |
| 23 1980-1983 CJ5, 1980-1986 CJ7, 1981-1986 CJ8, Shift Knob Lock Nut [Dana 300 Transfer Case] | 18607.05 |
| 24 1980-1983 CJ5, 1980-1986 CJ7, 1981-1986 CJ8, Shift Rod Cap Cover [Dana 300 Transfer Case] | 18672.17 |
| 25 1980-1983 CJ5, 1980-1986 CJ7, 1981-1986 CJ8, Shift Fork Plastic Insert [Dana 300 Transfer Case], [2 Needed] | 18674.24 |
| 26 1980-1983 CJ5, 1980-1986 CJ7, 1981-1986 CJ8, Shift Rod Oil Seal [Dana 300 Transfer Case], [2 Needed] | 18674.25 |
| 27 1980-1983 CJ5, 1980-1986 CJ7, 1981-1986 CJ8, Shift Rod Spring [Dana 300 Transfer Case], [2 Needed] | 18674.36 |
| 28 1980-1983 CJ5, 1980-1986 CJ7, 1981-1986 CJ8, Shim Set [Dana 300 Transfer Case], [8 Pcs] | 18674.26 |
| 1980-1983 CJ5, 1980-1986 CJ7, 1981-1986 CJ8, Shifter Boot [Dana 300 Transfer Case], [With SR4, T4, T5 Transmission] | 18606.04 |
| 1980-1983 CJ5, 1980-1986 CJ7, 1981-1986 CJ8, Shifter Boot [Dana 300 Transfer Case], [With T176, T177 Transmission] With Twin Stick Shifter | 18606.05 |
| 1980-1983 CJ5, 1980-1986 CJ7, 1981-1986 CJ8, Transfer Case Mount [Dana 300 Transfer Case] | 18608.02 |
| 1980-1983 CJ5, 1980-1986 CJ7, 1981-1986 CJ8, Polyurethane Mount [Dana 300 Transfer Case], Red | 18608.03 |
| 1980-1983 CJ5, 1980-1986 CJ7, 1981-1986 CJ8, Polyurethane Mount [Dana 300 Transfer Case], Black | 18608.04 |
| 1980-1983 CJ5, 1980-1986 CJ7, 1981-1986 CJ8, Stabilizer Stud, Transmission Mount [Dana 300 Transfer Case] | 18608.05 |
| 1980-1983 CJ5, 1980-1986 CJ7, 1981-1986 CJ8, Stabilizer Bushing [Dana 300 Transfer Case], [2 Needed] | 18608.06 |
| 1980-1983 CJ5, 1980-1986 CJ7, 1981-1986 CJ8, Polyurethane Stabilizer Bushing [Dana 300 Transfer Case], Pair, Red | 18608.07 |
| 1980-1983 CJ5, 1980-1986 CJ7, 1981-1986 CJ8, Polyurethane Stabilizer Bushing [Dana 300 Transfer Case], Pair, Black | 18608.08 |
| 1980-1983 CJ5, 1980-1986 CJ7, 1981-1986 CJ8, Main Shaft Collar [Dana 300 Transfer Case] | 18674.23 |

All images are subject to be representative. More detailed information is available online.

E. NP231 Transfer Case

Part#

| | |
|---|------------|
| 1988-1996 Cherokee [2.5L With Manual Transmission], Transfer Case Assembly [NP 231], 21 Spline Input Shaft [1.2" Long] | S-52099310 |
| 1994-1995 Wrangler [4.0L With Manual Transmission], Transfer Case Assembly [NP 231], 23 Spline Input Shaft | S-52098358 |
| 1994-1995 Wrangler [4.0L With Automatic Transmission], Transfer Case Assembly [NP 231], 23 Spline Input Shaft [2.1" Long] | S-52098360 |
| 1988-2001 Cherokee, 1988-2001 Wrangler, 1993-1998 grand Cherokee, Input Bearing Retainer Kit [NP 231 Transfer Case], Includes: Bearing & Seal | 18676.01 |
| 1988-2001 Cherokee, 1988-2001 Wrangler, 1993-1998 grand Cherokee, Input Shaft Oil Seal [NP 231 Transfer Case] | 18674.19 |
| 2002-2006 Wrangler, 2002-2007 Liberty, Input Shaft Oil Seal [NP 231 Transfer Case] | 18680.13 |
| 1991-2006 Wrangler, 1991-2001 Cherokee, 1993-1998 Grand Cherokee, 2002-2007 Liberty, Input Bearing Retainer [NP 231 Transfer Case] | 18680.11 |
| 1987-1993 Cherokee, 1988-1993 Wrangler, 1993 Grand Cherokee, Input Gear Outer Bearing [NP 231 Transfer Case] | 18676.04 |
| 1994-2006 Wrangler, 1994-2001 Cherokee, 1994-1998 Grand Cherokee, 2002-2007 Liberty, Input Gear Outer Bearing [NP 231 Transfer Case] | 18676.05 |
| 1997-2002 Wrangler, 1997-2000 Cherokee, Input Gear [NP 231 Transfer Case], 2.5L With Manual Transmission | 18676.58 |
| 1991-1996 Wrangler, 1991-1996 Cherokee, Input Gear [NP 231 Transfer Case], 21 Spline | 18676.08 |
| 1987-1990 Cherokee, 1988-1990 Wrangler, Input Gear [NP 231 Transfer Case], 23 Spline With Transfer Case ID # 53004271 | 18676.06 |
| 1988-1990 Cherokee, 1988-1990 Wrangler, Input Gear [NP 231 Transfer Case], 23 Spline With Transfer Case ID # 53008210, 52097893 Or 52098048 | 18676.07 |
| 1988-1990 Cherokee, 1988-1990 Wrangler, 1993-1994 Grand Cherokee [With MT], Input Gear [NP 231 Transfer Case], 23 Spline With Transfer Case ID # 53006093, 53006096 | 18676.09 |
| 1997-2002 Wrangler [2.5L With AT & 4.0L AT or MT], 1998-2000 Cherokee [2.5L With AT], Input Gear [NP 231 Transfer Case], 23 Spline | 18676.59 |
| 1997-1995 Wrangler, 1997-2001 Cherokee [4.0L], 2002 Liberty, Input Gear [NP 231 Transfer Case], 23 Spline | 18676.81 |
| 1995 Grand Cherokee, Input Gear [NP 231 Transfer Case], 23 Spline With ID #52097526 | 18676.10 |
| 1988-1996 Cherokee, 1988-1996 Wrangler, 1993-1996 Grand Cherokee, Input Gear Inner Bearing [NP 231 Transfer Case] | 18680.12 |
| 1994-2002 Wrangler, 1994-2001 Cherokee, 1997-1998 Grand Cherokee, 2002 Liberty, Input Gear Outer Bearing [NP 231 Transfer Case] | 18676.11 |
| 1997-2002 Wrangler, 1997-2001 Cherokee, 1997-1998 Grand Cherokee, 2002 Liberty, Drive Sprocket [NP 231 Transfer Case] | 18676.13 |
| 1988-1993 Wrangler, 1987-1993 Cherokee, Vacuum 4WD Switch | 18676.14 |
| 1998-2002 Wrangler, 1997-2001 Cherokee, Electric 4WD Switch | 18676.15 |
| 1987-1993 Wrangler, 1987-1993 Cherokee, Vacuum 4WD Switch Seal | 18680.15 |
| 1988-2001 Cherokee, 1988-2002 Wrangler, 1997-1998 Grand Cherokee, 2002 Liberty, Range Shift Fork [NP 231 Transfer Case] | 18676.17 |
| 1988-2001 Cherokee, 1988-2002 Wrangler, 1997-1998 Grand Cherokee, 2002 Liberty, Range Shift Fork Bushing [NP 231 Transfer Case], [2 Required] | 18676.18 |
| 1988-1996 Cherokee, 1988-1995 Wrangler, 1993-1996 Grand Cherokee, Shift Mode Synchronizer Assembly [NP 231 Transfer Case] | 18676.19 |
| 1988-1996 Cherokee, 1988-1995 Wrangler, 1993-1996 Grand Cherokee, Range Shift Hub [NP 231 Transfer Case] | 18676.21 |
| 1997-2002 Wrangler, 1997-2001 Cherokee, 1997-1998 Grand Cherokee, 2002 Liberty, Range Shift Hub [NP 231 Transfer Case] | 18676.22 |
| 1988-1990 Cherokee, 1988-1990 Wrangler, Range Shift Pad Set [NP 231 Transfer Case] | 18676.23 |
| 1991-2002 Wrangler, 1991-2001 Cherokee, 1993-1998 Grand Cherokee, 2002 Liberty, Range Shift Pad Set [NP 231 Transfer Case] | 18676.24 |
| 1988-1995 Wrangler, Case Extension [NP 231 Transfer Case], Rear NEW | 18676.25 |
| 1988-1996 Cherokee, 1988-1996 Wrangler, Mode Shift Fork [NP 231 Transfer Case] NEW | 18676.26 |
| 1997-1999 Wrangler, Mode Shift Fork [NP 231 Transfer Case] | 18676.27 |
| 1997-2006 Wrangler, 1987-2001 Cherokee, 2002-2007 Liberty, Mode Shift Fork [NP 231 Transfer Case] | 18676.80 |
| 1988-2001 Cherokee, 1988-2002 Wrangler, 1997-1998 Grand Cherokee, 2002 Liberty, Main Shaft Rear Bearing [NP 231 Transfer Case] | 18676.28 |
| 1988-2007 Models, Range Shift Fork Pad, Straight (.764"), [NP 231 Transfer Case] | 18680.27 |
| 1991-2006 Wrangler, 1991-2001 Cherokee, 1993-1998 Grand Cherokee, 2002-2007 Liberty, Output Shaft Oil Seal [NP 231 Transfer Case] | 18676.29 |
| 1987-1989 Cherokee, 1988-1989 Wrangler, Shift Mode Selector [NP 231 Transfer Case] | 18676.30 |
| 1991-1995 Wrangler, 1991-1996 Cherokee, Shift Mode Selector [NP 231 Transfer Case] | 18676.31 |
| 1997-1999 Wrangler, 1997-2001 Cherokee, Shift Mode Selector [NP 231 Transfer Case] | 18676.32 |
| 1988-1996 Cherokee, 1988-1995 Wrangler, Mode Shift Fork Bushing [NP 231 Transfer Case] | 18676.49 |
| 1988-2007 Models, Shift Selector O-Ring [NP 231 Transfer Case] | 18676.33 |

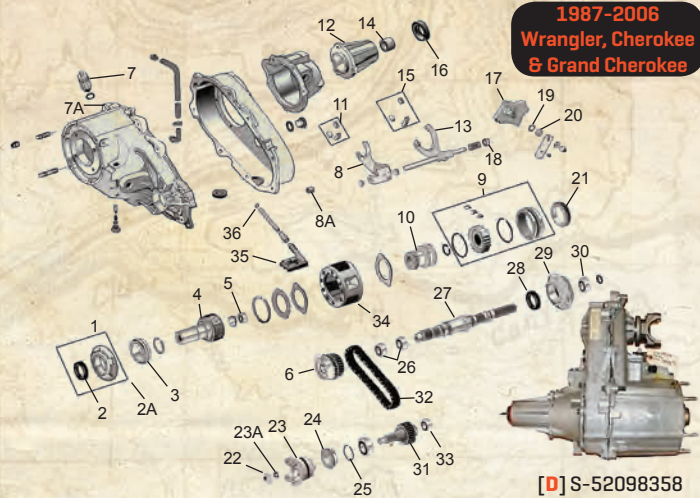

E. NP231 Transfer Case (continued)

Part#

| | |
|---|----------|
| 20 1988-2007 Models, Shift Selector Seal [NP 231 Transfer Case] | 18676.34 |
| 21 1988-1996 Cherokee, 1988-1995 Wrangler, Shift Mode Synchronizer Blocking Ring [NP 231 Transfer Case] | 18676.35 |
| 22 1988-1999 Wrangler, Output Yoke Nut [NP 231 Transfer Case], Front | 18676.36 |
| 23 1987-2001 Cherokee, 1993-1998 Grand Cherokee, Output Yoke [NP 231 Transfer Case], Front | 18676.39 |
| 23 1988-1995 Wrangler, Output Yoke [NP 231 Transfer Case], Front | 18676.37 |
| 23 1997-1999 Wrangler, Output Yoke [NP 231 Transfer Case], Front | 18676.38 |
| 1988-1995 Wrangler, Output Yoke Washer [NP 231 Transfer Case], Front | 18676.40 |
| 1997-2006 Wrangler, Output Yoke Washer [NP 231 Transfer Case], Front | 18680.32 |
| 1988-1996 Cherokee, 1988-1995 Wrangler, Yoke Strap & Bolt Kit [NP 231 Transfer Case] | 16582.03 |
| 24 1988-1996 Cherokee, 1988-1995 Wrangler, 2001 Wrangler, 2001 Cherokee, Output Shaft Seal [NP 231 Transfer Case], Front | 18676.41 |
| 24 1997-2000 Wrangler, 1997-2000 Cherokee, Output Shaft Seal [NP 231 Transfer Case], Front | 18676.56 |
| 25 1987-1996 Cherokee, 1988-2006 Wrangler, Output Shaft Bearing Retainer [NP 231 Transfer Case], Front | 18676.42 |
| 26 1988-1989 Wrangler, Main Drive Sprocket Bearing [NP 231 Transfer Case], [2 Required] | 18676.43 |
| 26 1991-1995 Wrangler, Main Drive Sprocket Bearing [NP 231 Transfer Case], [2 Required] | 18676.44 |
| 27 1987-1996 Cherokee, 1988-1995 Wrangler, Main Drive [NP 231 Transfer Case] | 18676.45 |
| 27 1997-1999 Wrangler [2.5L], 1997-1999 Cherokee, Main Drive [NP 231 Transfer Case] | 18676.57 |
| 28 1988-2001 Cherokee, 1988-2006 Wrangler, 1993-1998 Grand Cherokee, 2002 Liberty, Oil Pump Housing Oil Seal [NP 231 Transfer Case] | 18676.46 |
| 29 1988-2001 Cherokee, 1988-2001 Wrangler, 1993-1998 Grand Cherokee, Oil Pump Housing [NP 231 Transfer Case] | 18676.47 |
| 30 1988-2001 Cherokee, 1988-2006 Wrangler, 1993-1998 Grand Cherokee, 2002 Liberty, Output Shaft Bearing [NP 231 Transfer Case], Front or Rear | 18676.48 |
| 31 1988-2001 Cherokee, 1988-2002 Wrangler, 1993-1998 Grand Cherokee, Output Shaft [NP 231 Transfer Case], Front or Rear | 18676.50 |
| 1988-2001 Cherokee, 1988-2006 Wrangler, 1993-1998 Grand Cherokee, Output Shaft [NP 231 Transfer Case], Front or Rear | 18612.01 |
| 32 1988-2001 Cherokee, 1988-2006 Wrangler, 1993-1998 Grand Cherokee, 2002 Liberty, Output Shaft Bearing [NP 231 Transfer Case], Front Inner | 18676.51 |
| 1988-1996 Cherokee, 1987-1995 Wrangler, Output Shaft Slip Yoke [NP 231], Rear | 16580.53 |
| RTV Silicon [3 oz] | 19201.01 |
| 1988-2006 Wrangler, 1987-2001 Cherokee, 1993-1998 Grand Cherokee, Slip Yoke Eliminator Kit [NP 231] | 18676.60 |
| 1988-2006 Wrangler, 1987-2001 Cherokee, 1993-1998 Grand Cherokee, Mega Short Slip Yoke Eliminator Kit [NP 231] | 18676.72 |
| 1988-2006 Wrangler, 1987-2001 Cherokee, 1993-1998 Grand Cherokee, Service Yoke for Short Slip Yoke Eliminator Kit [NP 231] | 18676.61 |
| 1988-2006 Wrangler, 1987-2001 Cherokee, 1993-1998 Grand Cherokee, Speedometer Drive Gear for Short Slip Yoke Eliminator Kit [NP 231] | 18677.01 |
| 1988-2006 Wrangler, 1987-2001 Cherokee, 1993-1998 Grand Cherokee, Oil Seal for Short Slip Yoke Eliminator Kit [NP 231] | 18676.62 |
| 1988-2006 Wrangler, 1987-2001 Cherokee, 1993-1998 Grand Cherokee, HardWare Kit for Short Slip Yoke Eliminator Kit [NP 231] | 18676.64 |
| 34 1988-2001 Cherokee, 1988-2001 Wrangler, Planetary Gear [NP 231 Transfer Case] | 18680.55 |
| 1987-2001 Cherokee, 1988-2006 Wrangler, 1993-1998 Grand Cherokee, 2002 Liberty, Oil Filter [NP 231 Transfer Case], Front Inner | 18680.35 |
| 35 1988-2001 Cherokee, 1988-2006 Wrangler, 1993-2004 Grand Cherokee, Output Seal [NP 231 Transfer Case], Rear | 18676.76 |
| 1988-2001 Cherokee, 1988-2006 Wrangler, 1993-1998 Grand Cherokee, 2002 Liberty, Oil Tube O-Ring [NP 231 Transfer Case], Front Inner | 18680.36 |



NP242 1987-2002
NP249 1993-1998



OMIX-ADA, Inc.

[H] 18612.02

[F1] 18680.11

[F3] 18680.17

[F8] 18680.05

[I] 18679.23

| F. NP242 Transfer Case | Part# |
|---|----------|
| 1 1991-2007 Models, Input Bearing Retainer (NP 242 Transfer Case) | 18680.11 |
| 2 2002-2004 Grand Cherokee, 2003-2007 Liberty, Input Bearing Retainer Seal (NP 242 Transfer Case) | 18680.13 |
| 3 1987-2007 Models, Range Shift Fork (NP 242 Transfer Case) | 18680.17 |
| 4 1987-2007 Models, Range Shift Fork Pad, Straight (.764"), (NP 242 Transfer Case) | 18680.27 |
| 5 1987-2007 Models, Center Range Shift Fork Pad , Curved [2.375"] (NP 242 Transfer Case) | 18680.26 |
| 6 1987-2007 Models, Mode Shift Fork Pad , Curved [1.5"] (NP 242 Transfer Case) | 18680.25 |
| 7 1996-2001 Cherokee, 1996-1998 Grand Cherokee, Input Gear (NP 242 Transfer Case) | 18680.10 |
| 8 1996-2001 Cherokee, 1996-1998 Grand Cherokee, Rear Case (NP 242 Transfer Case) | 18680.05 |
| 9 1987-93 Wrangler , Vacuum Switch Seal (NP 242 Transfer Case) | 18680.15 |
| 10 1989-1996 Models, Range Sleeve (NP 242 Transfer Case) | 18680.18 |
| 11 1989-1995 Models, Planetary Gear (NP 242 Transfer Case) | 18680.55 |
| 12 1994-2000 Models, Main Shaft (NP 242 Transfer Case) | 18680.45 |
| 13 1987-2007 Models, Oil Tube O-Ring (NP 242 Transfer Case) | 18680.36 |
| 14 1987-2002 Models, Oil Filter (NP 242 Transfer Case) | 18680.35 |
| 15 1987-2001 Cherokee, 1987-2004 Grand Cherokee, Drive Sprocket (NP 242 Transfer Case) | 18680.16 |
| 16 1997-1998 Cherokee, 1997-2004 Grand Cherokee, 2002-2003 Liberty, Output Shaft Bearing (NP 242 Transfer Case) | 18680.48 |
| 17 1987-2001 Cherokee, 1993-1998 Grand Cherokee, Shift Lever Bushing (NP 242 Transfer Case) | 18680.19 |
| 18 1987-2007 Models, Front Output Yoke Washer (NP 242 Transfer Case) | 18680.32 |
| 19 1996-2001 Cherokee, 1993-1998 Grand Cherokee, Front Yoke (NP 242 Transfer Case) | 18680.30 |
| 20 1996-2001 Cherokee, 1993-2004 Grand Cherokee, 2002-2007 Liberty, Front Yoke Nut (NP 242 Transfer Case) | 18680.31 |

| G. NV249 Transfer Case | Part# |
|--|----------|
| 1 1993-1998 Grand Cherokee, Input Bearing Retainer (NV289 Transfer Case) | 18680.11 |
| 5 1993-1998 Grand Cherokee, Range Shift Fork Pad(NV289 Transfer Case) | 18680.26 |
| 7 1993-1998 Grand Cherokee, Input Gear (NV289 Transfer Case) | 18680.10 |
| 10 1993-1998 Grand Cherokee, Range Sleeve (NV289 Transfer Case) | 18680.18 |
| 11 1993-1998 Grand Cherokee, Planetary Gear (NV289 Transfer Case) | 18680.55 |
| 11 1993-1998 Grand Cherokee, Planetary Gear (NV289 Transfer Case) | 18676.55 |
| 16 1993-1998 Grand Cherokee, Output Shaft Bearing (NV289 Transfer Case) | 18680.48 |
| 19 1993-1998 Grand Cherokee, Front Yoke (NV289 Transfer Case) | 18680.30 |

| H. Transfer Case Chains | Part# |
|--|----------|
| 1984-1987 Cherokee, 1987 Wrangler, Transfer Case Chain (NP207) | 18612.02 |
| 1980-1983 Grand Wagoneer, 1980-1987 J-Series Truck, Transfer Case Chain (NP208) | 18612.03 |
| 1980-1991 Grand Wagoneer, 1984-1991 Cherokee, Transfer Case Chain (NP219) | 18612.04 |
| 1983-1991 Grand Wagoneer, 1983-1991 Cherokee, Transfer Case Chain (NP228 & NP229) | 18612.04 |
| 1989-1995 Cherokee, Transfer Case Chain (NP224) | 18612.05 |
| 1996-1998 Grand Cherokee, Transfer Case Chain (NP249) | 18612.06 |
| 1996-2004 Grand Cherokee, Transfer Case Chain (NP247) | 18612.07 |
| 1988-2006 Wrangler, 1987-2001 Cherokee, 1993-1998 Grand Cherokee, Transfer Case Chain (NP 231) | 18612.01 |

| I. Other Transfer Case Components | Part# |
|---|----------|
| 1980-1983 Grand Wagoneer, 1980-1987 J-Series Truck, Mode Range Shift Fork (NP208 Transfer Case) | 18679.23 |
| 1980-1983 Grand Wagoneer, 1980-1987 J-Series Truck, Output Bearing Snap Ring (NP208 Transfer Case), Front | 18679.39 |

All images are subject to be representative. More detailed information is available online.

Warner T90 3 Speed
1946-1971 CJ2A, 3A, 3B, 5, 6, M38, 475 Wagon & Truck

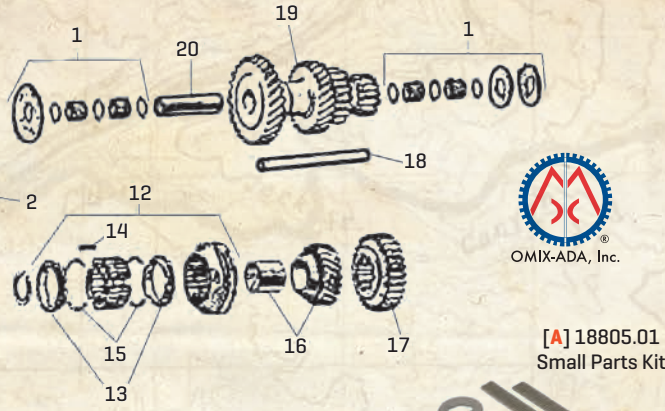

[A] 18805.01
Small Parts Kit

A. 1941-1971 T90 3 Speed Transmission

Part#

| | |
|--|----------|
| 1941-1971 Models, <i>Overhaul Repair Kit</i> (T90 3 Speed), Includes: Front & Rear Bearings, Gasket Kit & Small Parts Kits | 18801.01 |
| 1954-1964 Truck (226 CI), 1954-1964 Station Wagon (226 CI), <i>Overhaul Repair Kit</i> (T90 3 Speed), Includes: Front & Rear Bearings, Gasket Kit & Small Parts Kits | 18802.01 |
| 1954-1964 Truck (226 CI With GM V8 Swap), 1954-1964 Station Wagon (226 CI With GM V8 Swap), <i>Overhaul Repair Kit</i> (T90 3 Speed), Includes: Front & Rear Bearings, Gasket Kit & Small Parts Kits | 18802.02 |
| 1941-1971 Models, <i>Transmission Assembly</i> (T90 3 Speed), With 9-1/16" Input Shaft | 18803.01 |
| Delete Duplicate Listing | 18803.02 |
| 1941-1971 Models, <i>Gasket Set</i> (T90 3 Speed) | 18804.01 |
| 1 1941-1971 Models, <i>Small Parts Kit</i> (T90 3 Speed) | 18805.01 |
| 2 1941-1971 Models, <i>Transmission Bare Case</i> (T90 3 Speed) | 18880.01 |
| 1941-1971 Models, <i>Shifter Assembly</i> (T90 3 Speed), Includes Shift Forks and Shift Rails | 18880.02 |
| 3 1941-1971 Models (134 CI), <i>Front Bearing Retainer</i> (T90 3 Speed) | 18880.03 |
| 4 1941-1971 Models (134 CI), <i>Front Input Shaft Bearing</i> (T90 3 Speed) | 18880.04 |
| 5 1941-1971 Models (134 CI), <i>Rear Input Shaft Bearing</i> (T90 3 Speed) | 18880.05 |
| 6 1954-1964 Truck (226 CI), 1954-1964 Station Wagon (226 CI), <i>Rear Mainshaft Bearing Adapter</i> (T90 3 Speed) | 18880.06 |
| 7 1941-1971 Models (134 CI), <i>Input Shaft</i> (T90 3 Speed), 18 Tooth 9-1/16" | 18880.07 |
| 7 1941-1971 Models (134 CI), <i>Input Shaft</i> (T90 3 Speed), 16 Tooth 9-1/8" | 18880.08 |
| 7 1954-1964 Truck (226 CI), 1954-1964 Station Wagon (226 CI), <i>Input Shaft</i> (T90 3 Speed) | 18880.09 |
| 8 1941-1971 Models, <i>Main Shaft</i> (T90 3 Speed) | 18880.10 |
| 9 1941-1971 Models, <i>Main Shaft Nut</i> (T90 3 Speed) | 18880.11 |
| 10 1941-1971 Models, <i>Main Shaft Washer</i> (T90 3 Speed) | 18880.12 |
| 11 1941-1971 Models, <i>Main Shaft Bearing Spacer</i> (T90 3 Speed) | 18880.13 |
| 12 1941-1971 Models, <i>Synchronizer Assembly</i> (T90 3 Speed) | 18880.14 |
| 13 1941-1971 Models, <i>Synchronizer Blocking Ring</i> (T90 3 Speed) | 18880.15 |
| 14 1941-1971 Models, <i>Synchronizer Key</i> (T90 3 Speed), [3 Required] | 18880.16 |
| 15 1941-1971 Models, <i>Synchronizer Spring</i> (T90 3 Speed), [2 Required] | 18880.17 |
| 16 1941-1971 Models, <i>2nd Gear</i> (T90 3 Speed) | 18880.18 |
| 17 1941-1971 Models, <i>Low & Reverse Sliding Gear</i> (T90 3 Speed) | 18880.19 |
| 18 1941-1971 Models, <i>Counter Shaft</i> (T90 3 Speed) | 18880.20 |
| 19 1941-1971 Models, <i>Counter Shaft Cluster Gear</i> (T90 3 Speed), Tooth Count 33-26-19-14 | 18880.22 |
| 19 1941-1971 Models, <i>Counter Shaft Cluster Gear</i> (T90 3 Speed), Tooth Count 35-26-19-14 | 18880.23 |
| 20 1941-1971 Models, <i>Counter Shaft Cluster Gear Spacer</i> (T90 3 Speed) | 18880.24 |
| 21 1941-1971 Models, <i>Reverse Idler Shaft</i> (T90 3 Speed) | 18880.25 |
| 22 1941-1971 Models, <i>Reverse Idler Shaft Gear</i> (T90 3 Speed) | 18880.26 |
| 23 1941-1971 Models, <i>Reverse Idler Shaft Plate</i> (T90 3 Speed) | 18880.27 |
| 1941-1971 Models, <i>Shifter Boot</i> (T90 3 Speed) | 18806.01 |
| 1941-1971 Models, <i>Shifter Boot Ring</i> (T90 3 Speed) | 18880.28 |
| 1941-1971 Models, <i>Shifter Knob</i> (T90 3 Speed) | 18807.01 |
| 1941-1971 Models (134 CI), <i>Transmission Mount</i> (T90 3 Speed) | 18608.01 |
| 1954-1964 Truck, 1954-1964 Station Wagon, <i>Transmission Mount</i> (T90 3 Speed) | 18880.29 |
| 1941-1971 Models, <i>Transfer Case Insulator</i> (Snubber) Kit | 18608.15 |



[A] 18801.01



[A] 18806.01



[A] 18880.28

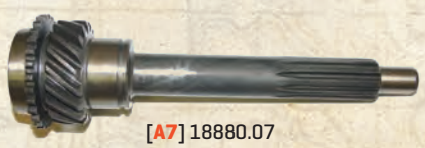

[A7] 18880.07



[A8] 18880.10



[A] 18880.29



[A] 18880.02



[A] 18880.14



[A] 18803.01



[A2] 18880.01

**Warner T14 & T15 3-Speed
1967-1971 225 V6 CJ, 1972-1975 Inline 6cyl 232 CJ**

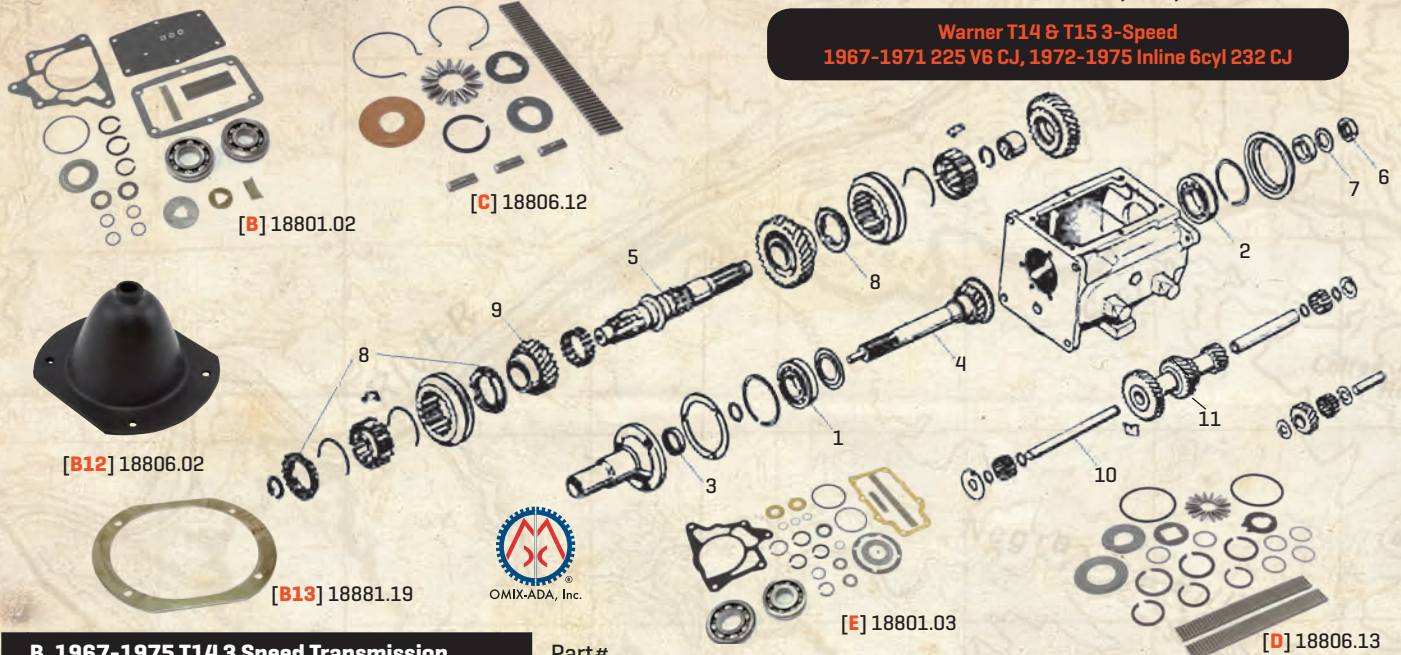

B. 1967-1975 T14 3 Speed Transmission

| Part# | Part# |
|---|----------|
| 1967-1975 Models, <i>Overhaul Repair Kit</i> [T14 3 Speed], Includes: Front & Rear Bearings, Gasket Kit & Small Parts Kit | 18801.02 |
| 1967-1975 Models, Gasket Set [T14 3 Speed] | 18804.02 |
| 1967-1975 Models, <i>Small Parts Kit</i> [T14 3 Speed] | 18805.02 |
| 1 1967-1975 Models, Front Input Shaft Bearing [T14 3 Speed] | 18881.01 |
| 2 1967-1975 Models, Main Shaft Bearing [T14 3 Speed] | 18881.02 |
| 3 1967-1975 Models, Main Shaft Oil Seal Retainer [T14 3 Speed] | 18881.03 |
| 4 1967-1971 Models [225 Ci], Input Shaft [T14 3 Speed], 20 Tooth [11.5"] | 18881.04 |
| 4 1972-1975 Models [3.8L & 4.2L], Input Shaft [T14 3 Speed], 20 Tooth [10.5"] | 18881.05 |
| 5 1967-1975 Models, Main Shaft [T14 3 Speed] | 18881.06 |
| 6 1967-1975 Models, Main Shaft Nut [T14 3 Speed] | 18880.11 |
| 7 1967-1975 Models, Main Shaft Washer [T14 3 Speed] | 18880.12 |
| 8 1967-1975 Models, Synchronizer Blocker Ring [T14 3 Speed], [2 Required] | 18881.08 |
| 9 1967-1975 Models, 2nd Gear [T14 3 Speed], 26 Tooth | 18881.10 |
| 10 1967-1975 Models, Counter Shaft [T14 3 Speed] | 18881.14 |
| 11 1967-1971 Models [225 Ci], Cluster Gear [T14 3 Speed], 31-25-15-14 Teeth | 18881.15 |
| 12 1967-1975 Models, Shifter Boot [T14 3 Speed] | 18806.02 |
| 13 1967-1975 Models, Shifter Boot Retainer [T14 3 Speed] | 18881.19 |
| 1967-1975 Models, Shifter Knob [T14 3 Speed] | 18807.01 |
| 1967-1971 Models [225 Ci], Transmission Mount [T14 3 Speed] | 18881.20 |
| 1972-1975 Models [3.8L & 4.2L], Transmission Mount [T14 3 Speed] | 18608.02 |
| 1972-1975 Models [3.8L & 4.2L], Transmission Mount [T14 3 Speed], Urethane, Red UPGRADE | 18392.01 |
| 1972-1975 Models [3.8L & 4.2L], Transmission Mount [T14 3 Speed], Urethane, Black UPGRADE | 18608.04 |
| 1972-1975 Models [3.8L & 4.2L], Stabilizer Stud, Transmission Mount [T14 3 Speed] | 18608.05 |
| 1972-1975 Models [3.8L & 4.2L], Stabilizer Stud Bushing, Transmission Mount [T14 3 Speed] | 18608.06 |
| 1972-1975 Models [3.8L & 4.2L], Stabilizer Bushing, Transmission Mount [T14 3 Speed], Urethane, Red UPGRADE | 18369.01 |
| 1972-1975 Models [3.8L & 4.2L], Stabilizer Bushing, Transmission Mount [T14 3 Speed], Urethane, Black UPGRADE | 18608.08 |

C. 1941-1945 T84 3 Speed Transmission

| Part# | Part# |
|---|----------|
| 1941-1945 MB, 1941-1945 Ford GPW, <i>Small Parts Kit</i> [T84 3 Speed] | 18806.12 |
| 1941-1945 MB, 1941-1945 Ford GPW, Blocking Ring [T84 3 Speed], [2 Required] | 18889.01 |
| 1941-1945 MB, 1941-1945 Ford GPW, Main Drive Gear Bearing [T84 3 Speed] | 18891.02 |
| 1941-1945 MB, 1941-1945 Ford GPW, Rear Main Shaft Bearing [T84 3 Speed] | 18880.05 |
| 1941-1945 MB, 1941-1945 Ford GPW, Front Bearing Retainer [T84 3 Speed] | 18889.03 |
| 1941-1945 MB, 1941-1945 Ford GPW, Shifter Boot [T84 3 Speed] | 18889.04 |
| 1941-1945 MB, 1941-1945 Ford GPW, Transfer Case Shifter Boot | 18889.05 |
| 1941-1945 MB, 1941-1945 Ford GPW, Shifter Boot Kit [T84 3 Speed], Includes: Transmission, Transfer Case & Accelerator Cable Boots | 18889.06 |

D. 1955-1972 T98 4 Speed Transmission

| Part# | Part# |
|---|----------|
| 1955-1972 CJ5, 1955-1972 CJ6, <i>Small Parts Kit</i> [T98 4 Speed] | 18806.13 |
| 1955-1972 CJ5, 1955-1972 CJ6, Front Input Shaft Bearing [T98 4 Speed] | 18882.01 |
| 1955-1972 CJ5, 1955-1972 CJ6, Rear Input Shaft Bearing [T98 4 Speed] | 18884.02 |
| 1955-1972 CJ5, 1955-1972 CJ6, 2nd Gear [T98 4 Speed] | 18890.01 |
| 1955-1972 CJ5, 1955-1972 CJ6, Counter Shaft Cluster Gear [T98 4 Speed] | 18890.02 |
| 1955-1972 CJ5, 1955-1972 CJ6, Counter Shaft [T98 4 Speed] | 18890.03 |
| 1955-1972 CJ5, 1955-1972 CJ6, Synchronizer Assembly [T98 4 Speed], 3rd & 4th Gear | 18890.04 |
| 1955-1972 CJ5, 1955-1972 CJ6, Synchronizer Blocking Ring [T98 4 Speed], 3rd & 4th Gear [2 Required] | 18890.05 |
| 1955-1972 CJ5, 1955-1972 CJ6, Synchronizer Blocking Ring [T98 4 Speed], 1st & 2nd Gear [2 Required] | 18890.06 |

E. 1972-1979 Warner T15 3 Speed Transmission

| Part# | Part# |
|---|----------|
| 1972-1979 CJ5, 1972-1975 CJ6, 1972-1979 CJ7, <i>Overhaul Kit</i> [T15 3 Speed], Includes: Bearings, Gaskets & Small Parts Kit | 18801.03 |
| 1972-1979 CJ5, 1972-1975 CJ6, 1972-1979 CJ7, Gasket Set [T15 3 Speed] | 18804.03 |
| 1972-1979 CJ5, 1972-1975 CJ6, 1972-1979 CJ7, <i>Small Parts Kit</i> [T15 3 Speed] | 18805.03 |
| 1 1972-1979 CJ5, 1972-1975 CJ6, 1972-1979 CJ7, Front Input Shaft Bearing [T15 3 Speed] | 18882.01 |
| 2 1972-1979 CJ5, 1972-1975 CJ6, 1972-1979 CJ7, Main Shaft Bearing [T15 3 Speed] | 18882.02 |
| 3 1972-1979 CJ5, 1972-1975 CJ6, 1972-1979 CJ7, Front Oil Seal Retainer [T15 3 Speed] | 18881.03 |
| 8 1972-1979 CJ5, 1972-1975 CJ6, 1972-1979 CJ7, Synchronizer Ring [T15 3 Speed], 1st, 2nd & 3rd Gear [3 Required] | 18882.03 |
| 9 1972-1979 CJ5, 1972-1975 CJ6, 1972-1979 CJ7, Counter Shaft [T15 3 Speed] | 18882.04 |
| 12 1972-1979 CJ5, 1972-1975 CJ6, 1972-1979 CJ7, Shifter Boot [T15 3 Speed] | 18806.02 |
| 13 1972-1979 CJ5, 1972-1975 CJ6, 1972-1979 CJ7, Shifter Boot Retainer [T15 3 Speed] | 18881.19 |
| 1972-1979 CJ5, 1972-1975 CJ6, 1972-1979 CJ7, Shifter Knob [T15 3 Speed] | 18807.01 |
| 1972-1979 CJ5, 1972-1975 CJ6, 1976-1979 CJ7, Transfer Case Mount [T15 3 Speed] | 18608.02 |
| 1972-1979 CJ5, 1972-1975 CJ6, 1976-1979 CJ7, Polyurethane Mount [T15 3 Speed], Red | 18392.01 |
| 1972-1979 CJ5, 1972-1975 CJ6, 1976-1979 CJ7, Polyurethane Mount [T15 3 Speed], Black | 18608.04 |
| 1972-1979 CJ5, 1972-1975 CJ6, 1976-1979 CJ7, Stabilizer Stud, Transmission Mount [T15 3 Speed] | 18608.05 |
| 1972-1979 CJ5, 1972-1975 CJ6, 1976-1979 CJ7, Stabilizer Bushing [T15 3 Speed], [2 Required] | 18608.06 |
| 1972-1979 CJ5, 1972-1975 CJ6, 1976-1979 CJ7, Polyurethane Stabilizer Bushing [T15 3 Speed], Red, Pair | 18369.01 |
| 1972-1979 CJ5, 1972-1975 CJ6, 1976-1979 CJ7, Polyurethane Stabilizer Bushing [T15 3 Speed], Black, Pair | 18608.08 |

All images are subject to be representative. More detailed information is available online.

Tremec T150 3-Speed
1976-1979 6cyl & 8cyl CJ5 & CJ7

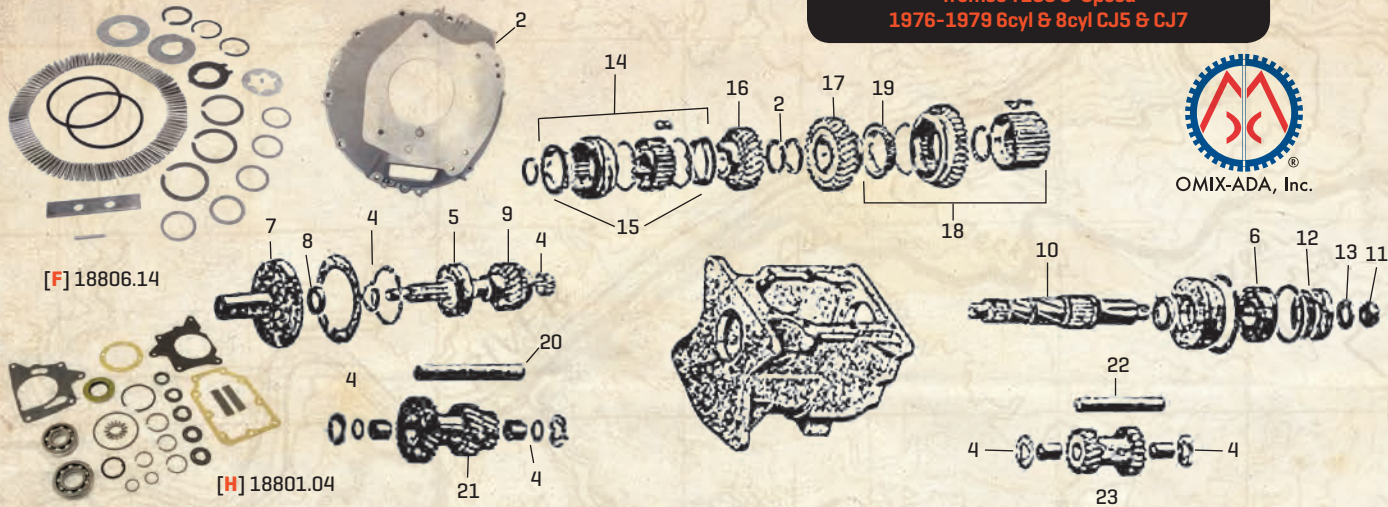

F. 1972-1979 Warner T18 4 Speed Transmission

| Part# | Description |
|----------|--|
| 18806.14 | 1972-1979 CJ5, 1972-1975 CJ6, 1972-1979 CJ7, <i>Overhaul Kit</i> [T18 4 Speed]. Includes: Bearings, Gaskets & Small Parts Kit |
| 18882.01 | 1972-1979 CJ5, 1972-1975 CJ6, 1972-1979 CJ7, Front Input Shaft Bearing [T18 4 Speed] |
| 18884.02 | 1972-1979 CJ5, 1972-1975 CJ6, 1972-1979 CJ7, Main Shaft Bearing [T18 4 Speed] |
| 18885.03 | 1972-1979 CJ5, 1972-1975 CJ6, 1972-1979 CJ7, Front Input Oil Seal [T18 4 Speed] |
| 18890.20 | 1972-1979 CJ5, 1972-1975 CJ6, 1972-1979 CJ7, 1st Gear [T18 4 Speed] |
| 18890.21 | 1972-1979 CJ5, 1972-1975 CJ6, 1972-1979 CJ7, Front Bearing Retainer [T18 4 Speed] |
| 18890.22 | 1972-1979 CJ5, 1972-1975 CJ6, 1972-1979 CJ7, 3rd Gear [T18 4 Speed] |
| 18890.04 | 1972-1979 CJ5, 1972-1975 CJ6, 1972-1979 CJ7, 3rd & 4th Gear Synchronizer Assembly [T18 4 Speed] |
| 18890.23 | 1972-1979 CJ5, 1972-1975 CJ6, 1972-1979 CJ7, Synchronizer Assembly [T18 4 Speed], For Tag #13-01-192, 13-01-193, 13-01-209, 13-01-210 |
| 18890.05 | 1972-1979 CJ5, 1972-1975 CJ6, 1972-1979 CJ7, 3rd & 4th Gear Blocking Ring [T18 4 Speed], [2 Required] |
| 18890.25 | 1972-1979 CJ5, 1972-1975 CJ6, 1972-1979 CJ7, 3rd & 4th Gear Blocking Ring [T18 4 Speed], For Tag #13-01-192, 13-01-193, 13-01-209, 13-01-210, [2 Required] |
| 18890.26 | 1972-1979 CJ5, 1972-1975 CJ6, 1972-1979 CJ7, Reverse Idler Gear [T18 4 Speed] |
| 18890.03 | 1972-1979 CJ5, 1972-1975 CJ6, 1972-1979 CJ7, Counter Shaft [T18 4 Speed] |
| 18890.06 | 1972-1979 CJ5, 1972-1975 CJ6, 1972-1979 CJ7, 1st & 2nd Gear Blocking Ring [T18 4 Speed] |

G. 1980-1981 SR4 4 Speed Transmission

| Part# | Description |
|----------|--|
| 16916.02 | 1980-1981 CJ5, 1980-1981 CJ7, 1981 CJ8, Bellhousing [SR4 4 Speed] |
| 18891.02 | 1980-1981 CJ5, 1980-1981 CJ7, 1981 CJ8, Front Input Bearing [SR4 4 Speed] |
| 18891.02 | 1980-1981 CJ5, 1980-1981 CJ7, 1981 CJ8, Main Shaft Bearing [SR4 4 Speed] |
| 18885.14 | 1980-1981 CJ5, 1980-1981 CJ7, 1981 CJ8, 1st & 2nd Gear Blocking Ring [SR4 4 Speed], [2 Required] |
| 18885.23 | 1980-1981 CJ5, 1980-1981 CJ7, 1981 CJ8, 3rd & 4th Gear Blocking Ring [SR4 4 Speed], [2 Required] |
| 18891.03 | 1980-1981 CJ5, 1980-1981 CJ7, 1981 CJ8, Main Drive [SR4 4 Speed] |
| 18806.03 | 1980-1981 CJ5, 1980-1981 CJ7, 1981 CJ8, Shifter Boot [SR4 4 Speed] |
| 18881.03 | 1980-1981 CJ5, 1980-1981 CJ7, 1981 CJ8, Front Bearing Retainer Oil Seal [SR4 4 Speed] |
| 18885.08 | 1980-1981 CJ5, 1980-1981 CJ7, 1981 CJ8, Rear Output Shaft Oil Seal [SR4 4 Speed] |
| 18608.02 | 1980-1981 CJ5, 1980-1981 CJ7, 1981 CJ8, Transfer Case Mount [SR4 4 Speed] |
| 18392.01 | 1980-1981 CJ5, 1980-1981 CJ7, 1981 CJ8, Polyurethane Mount [SR4 4 Speed], Red |
| 18608.04 | 1980-1981 CJ5, 1980-1981 CJ7, 1981 CJ8, Polyurethane Mount [SR4 4 Speed], Black |
| 18608.05 | 1980-1981 CJ5, 1980-1981 CJ7, 1981 CJ8, Stabilizer Stud, Transmission Mount [SR4 4 Speed] |
| 18608.06 | 1980-1981 CJ5, 1980-1981 CJ7, 1981 CJ8, Stabilizer Bushing [SR4 4 Speed], [2 Required] |
| 18369.01 | 1980-1981 CJ5, 1980-1981 CJ7, 1981 CJ8, Polyurethane Stabilizer Bushing [SR4 4 Speed], Red, Pair |
| 18608.08 | 1980-1981 CJ5, 1980-1981 CJ7, 1981 CJ8, Polyurethane Stabilizer Bushing [SR4 4 Speed], Black, Pair |

H. 1976-1979 Tremec T150 3 Speed Transmission

| Part# | Description |
|----------|---|
| 18801.04 | 1976-1979 CJ5, 1976-1979 CJ7, <i>Overhaul Kit</i> [T150 3 Speed]. Includes: Front & Rear Bearings, Gaskets & Seals Kit & Small Parts Kits |
| 18802.05 | 1976-1979 CJ5, 1976-1979 CJ7, <i>Overhaul Kit</i> [T150 3 Speed]. Includes: Main Shaft, Input Shaft, 1st Gear, 2nd Gear, Low & Reverse Synchro Assy, 2-3 Synchro Assy, Cluster Gear & Shaft, Reverse Idler Gear W/ Shaft, Front & Rear Bearings, Front & Rear Oil Seals, Gasket Kit, <i>Small Parts Kit</i> |
| 16916.01 | 1976-1979 CJ5, 1976-1979 CJ7, Bellhousing [T150 3 Speed] |
| 18804.04 | 1976-1979 CJ5, 1976-1979 CJ7, Gasket Set [T150 3 Speed] |
| 18805.04 | 1976-1979 CJ5, 1976-1979 CJ7, <i>Small Parts Kit</i> [T150 3 Speed] |
| 18880.04 | 1976-1979 CJ5, 1976-1979 CJ7, Front Input Shaft Bearing [T150 3 Speed] |
| 18880.05 | 1976-1979 CJ5, 1976-1979 CJ7, Rear Main Shaft Bearing [T150 3 Speed] |
| 18883.01 | 1976-1979 CJ5, 1976-1979 CJ7, Input Shaft Bearing Retainer [T150 3 Speed] |
| 18881.03 | 1976-1979 CJ5, 1976-1979 CJ7, Main Shaft Bearing Retainer [T150 3 Speed] |
| 18883.02 | 1976-1979 CJ5, 1976-1979 CJ7, Input Shaft [T150 3 Speed] |
| 18883.03 | 1976-1979 CJ5, 1976-1979 CJ7, Main Shaft [T150 3 Speed] |
| 18880.11 | 1976-1979 CJ5, 1976-1979 CJ7, Main Shaft Nut [T150 3 Speed] |
| 18883.04 | 1976-1979 CJ5, 1976-1979 CJ7, Main Shaft Oil Seal [T150 3 Speed] |
| 18880.12 | 1976-1979 CJ5, 1976-1979 CJ7, Main Shaft Washer [T150 3 Speed] |
| 18883.05 | 1976-1979 CJ5, 1976-1979 CJ7, 2nd & 3rd Synchronizer Assembly [T150 3 Speed] |
| 18883.06 | 1976-1979 CJ5, 1976-1979 CJ7, 2nd & 3rd Synchronizer Blocking Ring [T150 3 Speed], [2 Required] |
| 18883.07 | 1976-1979 CJ5, 1976-1979 CJ7, 2nd Gear [T150 3 Speed] |
| 18883.08 | 1976-1979 CJ5, 1976-1979 CJ7, Low Gear [T150 3 Speed] |
| 18883.09 | 1976-1979 CJ5, 1976-1979 CJ7, 1st & Reverse Synchronizer Assembly [T150 3 Speed], [2 Required] |
| 18883.10 | 1976-1979 CJ5, 1976-1979 CJ7, 1st & Reverse Synchronizer Blocking Ring [T150 3 Speed], [2 Required] |
| 18883.11 | 1976-1979 CJ5, 1976-1979 CJ7, Counter Shaft [T150 3 Speed] |
| 18883.12 | 1976-1979 CJ5, 1976-1979 CJ7, Counter Shaft Cluster Gear [T150 3 Speed] |
| 18883.13 | 1976-1979 CJ5, 1976-1979 CJ7, Reverse Idler Shaft [T150 3 Speed] |
| 18883.14 | 1976-1979 CJ5, 1976-1979 CJ7, Reverse Idler Gear [T150 3 Speed], With Bushing |
| 18806.02 | 1976-1979 CJ5, 1976-1979 CJ7, Shifter Boot [T150 3 Speed] |
| 18881.19 | 1976-1979 CJ5, 1976-1979 CJ7, Shifter Boot Retainer [T150 3 Speed] |
| 18807.01 | 1976-1979 CJ5, 1976-1979 CJ7, Shifter Knob [T150 3 Speed] |
| 18608.02 | 1976-1979 CJ5, 1976-1979 CJ7, Transfer Case Mount [T150 3 Speed] |
| 18392.01 | 1976-1979 CJ5, 1976-1979 CJ7, Polyurethane Mount [T150 3 Speed], Red |
| 18608.04 | 1976-1979 CJ5, 1976-1979 CJ7, Polyurethane Mount [T150 3 Speed], Black |
| 18608.05 | 1976-1979 CJ5, 1976-1979 CJ7, Stabilizer Stud, Transmission Mount [T150 3 Speed] |
| 18608.06 | 1976-1979 CJ5, 1976-1979 CJ7, Stabilizer Bushing [T150 3 Speed], [2 Required] |
| 18369.01 | 1976-1979 CJ5, 1976-1979 CJ7, Polyurethane Stabilizer Bushing [T150 3 Speed], Red, Pair |
| 18608.08 | 1976-1979 CJ5, 1976-1979 CJ7, Polyurethane Stabilizer Bushing [T150 3 Speed], Black, Pair |
| 18883.15 | 1976-1979 CJ5, 1976-1979 CJ7, 1st & Reverse Shifter Fork [T150 3 Speed] |
| 18883.16 | 1976-1979 CJ5, 1976-1979 CJ7, 2nd & 3rd Gear Shifter Fork [T150 3 Speed] |

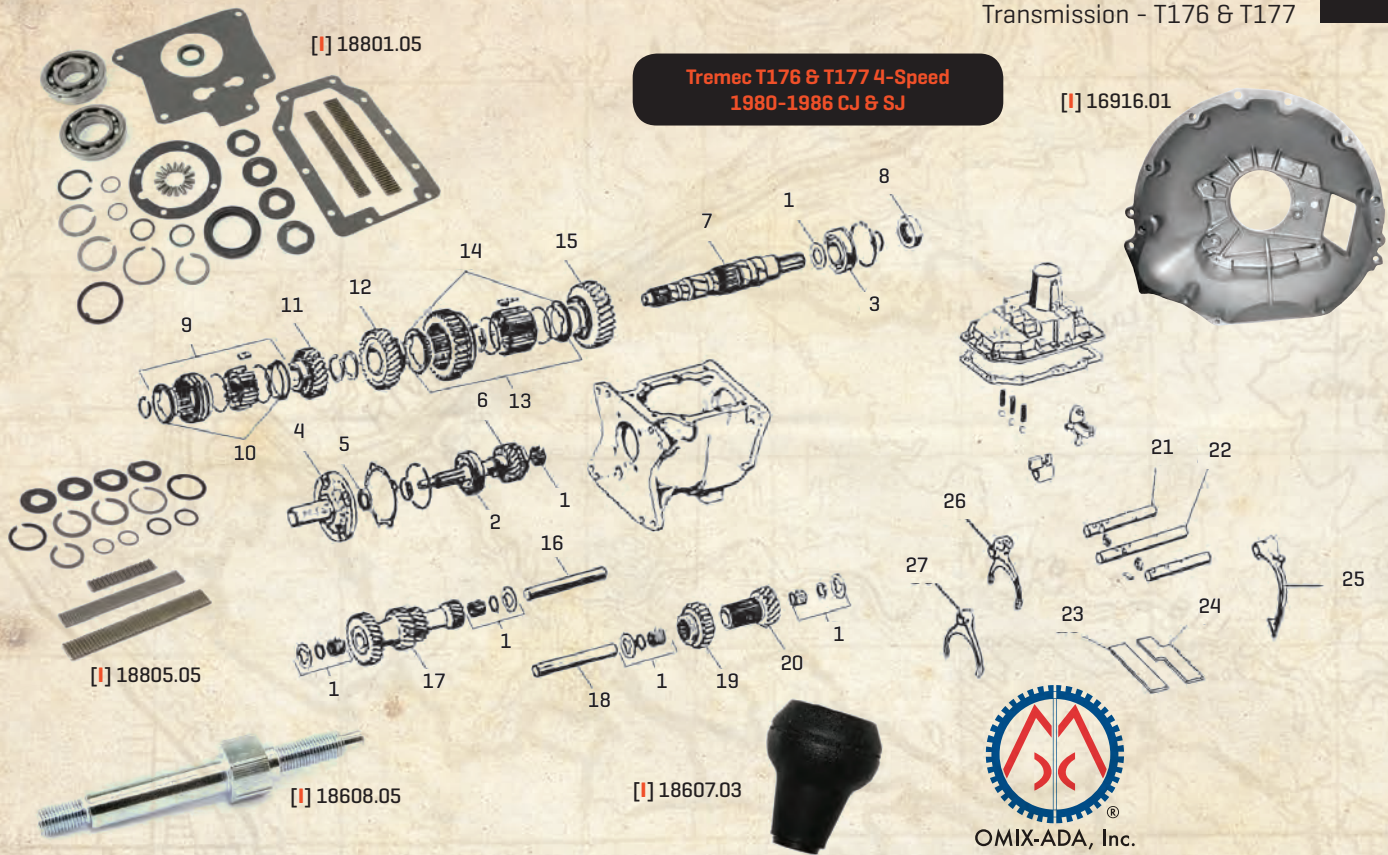

| I. 1976-1979 Tremec T176 & T177 4 Speed Transmissions | Part# |
|--|----------|
| 1976-1979 CJ5, 1976-1979 CJ7, Overhaul Kit [T176 & T177 4 Speeds], Includes: Front & Rear Bearings, Gaskets & Seals Kit & Small Parts Kits | 18801.05 |
| 1976-1979 CJ5, 1976-1979 CJ7, Bellhousing [T176 & T177 4 Speeds] | 16916.01 |
| 1976-1979 CJ5, 1976-1979 CJ7, Gaskets Set [T176 & T177 4 Speeds] | 18804.05 |
| 1 1976-1979 CJ5, 1976-1979 CJ7, Small Parts Kit [T176 & T177 4 Speeds] | 18805.05 |
| 2 1976-1979 CJ5, 1976-1979 CJ7, Front Input Shaft Bearing [T176 & T177 4 Speeds] | 18884.01 |
| 3 1976-1979 CJ5, 1976-1979 CJ7, Rear Main Shaft Bearing [T176 & T177 4 Speeds] | 18884.02 |
| 4 1976-1979 CJ5, 1976-1979 CJ7, Input Shaft Bearing Retainer [T176 & T177 4 Speeds] | 18884.03 |
| 5 1976-1979 CJ5, 1976-1979 CJ7, Input Shaft Bearing Retainer Oil Seal [T176 & T177 4 Speeds] | 18881.03 |
| 6 1976-1979 CJ5, 1976-1979 CJ7, Input Shaft [T177 4 Speeds], 19 Tooth | 18884.05 |
| 7 1976-1979 CJ5, 1976-1979 CJ7, Main Shaft [T176 & T177 4 Speeds] | 18884.06 |
| 8 1976-1979 CJ5, 1976-1979 CJ7, Input Shaft Seal [T176 & T177 4 Speeds] | 18676.02 |
| 9 1976-1979 CJ5, 1976-1979 CJ7, 3rd & 4th Gear Synchronizer Assembly [T176 & T177 4 Speeds] | 18884.08 |
| 10 1976-1979 CJ5, 1976-1979 CJ7, 3rd & 4th Gear Synchronizer Blocking Ring [T176 & T177 4 Speeds] | 18883.10 |
| 11 1976-1979 CJ5, 1976-1979 CJ7, 3rd Gear [T176 4 Speeds], 23 Tooth | 18884.10 |
| 11 1976-1979 CJ5, 1976-1979 CJ7, 3rd Gear [T177 4 Speeds], 22 Tooth | 18884.11 |
| 12 1976-1979 CJ5, 1976-1979 CJ7, 2nd Gear [T177 4 Speeds], 32 Tooth | 18884.13 |
| 13 1976-1979 CJ5, 1976-1979 CJ7, 1st & 2nd Gear Synchronizer Assembly [T176 & T177 4 Speeds] | 18884.14 |
| 14 1976-1979 CJ5, 1976-1979 CJ7, 1st & 2nd Gear Synchronizer Blocking Ring [T176 & T177 4 Speeds], [2 Required] | 18883.10 |
| 14 1976-1979 CJ5, 1976-1979 CJ7, Blocking Ring Kit [T176 & T177 4 Speeds], 4 Included | 18884.15 |
| 15 1976-1979 CJ5, 1976-1979 CJ7, 1st Gear [T176 & T177 4 Speeds] | 18884.16 |
| 16 1976-1979 CJ5, 1976-1979 CJ7, Counter Shaft [T176 & T177 4 Speeds] | 18884.17 |
| 17 1976-1979 CJ5, 1976-1979 CJ7, Counter Shaft Cluster Gear [T176 & T177 4 Speeds], 34-27-25-15 Tooth Count | 18884.18 |
| 17 1976-1979 CJ5, 1976-1979 CJ7, Counter Shaft Cluster Gear [T176 & T177 4 Speeds], 33-26-24-15 Tooth Count | 18884.20 |

| I. 1976-1979 Tremec T176 & T177 4 Speed Transmissions (continued) | Part# |
|---|----------|
| 18 1976-1979 CJ5, 1976-1979 CJ7, Reverse Idler Shaft [T176 & T177 4 Speeds] | 18884.21 |
| 19 1976-1979 CJ5, 1976-1979 CJ7, Reverse Idler Sliding Gear [T176 & T177 4 Speeds] | 18884.22 |
| 20 1976-1979 CJ5, 1976-1979 CJ7, Reverse Idler Gear [T176 & T177 4 Speeds] | 18884.23 |
| 1976-1979 CJ5, 1976-1979 CJ7, Bellhousing [T176 & T177 4 Speeds] | 16916.01 |
| 21 1976-1979 CJ5, 1976-1979 CJ7, 1st & 2nd Gear Shift Rail [T176 & T177 4 Speeds] | 18884.25 |
| 22 1976-1979 CJ5, 1976-1979 CJ7, 3rd & 4th Gear Shift Rail [T176 & T177 4 Speeds] | 18884.26 |
| 23 1976-1979 CJ5, 1976-1979 CJ7, Shift Rail Plate [T176 & T177 4 Speeds], Front | 18884.27 |
| 24 1976-1979 CJ5, 1976-1979 CJ7, Shift Rail Plate [T176 & T177 4 Speeds], Rear | 18884.28 |
| 25 1976-1979 CJ5, 1976-1979 CJ7, Reverse Shift Fork [T176 & T177 4 Speeds] | 18884.29 |
| 26 1976-1979 CJ5, 1976-1979 CJ7, 1st & 2nd Gear Shift Fork [T176 & T177 4 Speeds] | 18884.30 |
| 27 1976-1979 CJ5, 1976-1979 CJ7, 3rd & 4th Gear Shift Fork [T176 & T177 4 Speeds] | 18884.31 |
| 1976-1979 CJ5, 1976-1979 CJ7, Shifter Service Kit [T176 & T177 4 Speeds] | 18884.32 |
| 1976-1979 CJ5, 1976-1979 CJ7, Shifter Boot [T176 & T177 4 Speeds] | 18606.05 |
| 1976-1979 CJ5, 1976-1979 CJ7, Shifter Knob [T176 & T177 4 Speeds] | 18607.03 |
| 1976-1979 CJ5, 1976-1979 CJ7, Shifter Knob Insert [T176 & T177 4 Speeds] | 18884.33 |
| 1976-1979 CJ5, 1976-1979 CJ7, Shifter Knob Lock Nut [T176 & T177 4 Speeds] | 18607.05 |
| 1976-1979 CJ5, 1976-1979 CJ7, Transfer Case Mount [T176 & T177 4 Speeds] | 18608.02 |
| 1976-1979 CJ5, 1976-1979 CJ7, Polyurethane Mount [T176 & T177 4 Speeds], Red | 18392.01 |
| 1976-1979 CJ5, 1976-1979 CJ7, Polyurethane Mount [T176 & T177 4 Speeds], Black | 18608.04 |
| 1976-1979 CJ5, 1976-1979 CJ7, Stabilizer Stud, Transmission Mount [T176 & T177 4 Speeds] | 18608.05 |
| 1976-1979 CJ5, 1976-1979 CJ7, Stabilizer Bushing [T176 & T177 4 Speeds], [2 Required] | 18608.06 |
| 1976-1979 CJ5, 1976-1979 CJ7, Polyurethane Stabilizer Bushing [T176 & T177 4 Speeds], Red, Pair | 18369.01 |
| 1976-1979 CJ5, 1976-1979 CJ7, Polyurethane Stabilizer Bushing [T176 & T177 4 Speeds], Black, Pair | 18608.08 |
| 1976-1979 CJ5, 1976-1979 CJ7, Shifter Lever [T176 & T177 4 Speeds] | 18884.37 |

All images are subject to be representative. More detailed information is available online.

Peugot BA 10/5 5-Speed
1987-1989 Wrangler & Cherokee



[J] 18801.11



OMIX-ADA, Inc.



[J] 19201.01

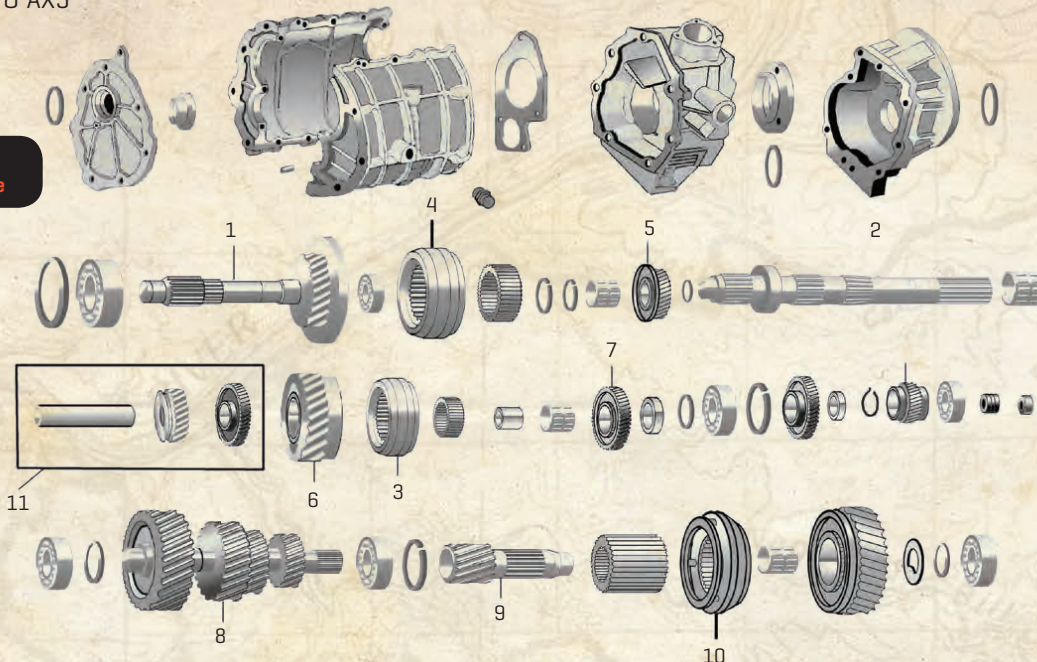

[K] 18803.04



J. Peugeot BA 10 5 Speed Transmission

Part#

| | |
|---|----------|
| 1987-1989 Wrangler, 1987-1989 Cherokee, Bearing & Seal Kit [BA10 5 Speed] | 18801.11 |
| RTV Silicon [3 oz] | 19201.01 |
| 1987-1989 Wrangler, 1987-1989 Cherokee, Input Shaft [BA10 5 Speed] | 18888.01 |
| 1987-1989 Wrangler, 1987-1989 Cherokee, Input Shaft [BA10 5 Speed] | 18888.02 |
| 1987-1989 Wrangler, 1987-1989 Cherokee, Main Shaft [BA10 5 Speed] | 18888.03 |
| 1987-1989 Wrangler, 1987-1989 Cherokee, 1st & 2nd Gear Synchronizer Assembly [BA10 5 Speed] | 18888.04 |
| 1987-1989 Wrangler, 1987-1989 Cherokee, 3rd & 4th Gear Synchronizer Assembly [BA10 5 Speed] | 18888.05 |
| 1987-1989 Wrangler, 1987-1989 Cherokee, 3rd Gear [BA10 5 Speed] | 18888.06 |
| 1987-1989 Wrangler, 1987-1989 Cherokee, 2nd Gear [BA10 5 Speed] | 18888.07 |
| 1987-1989 Wrangler, 1987-1989 Cherokee, 1st Gear [BA10 5 Speed] 12-32 Tooth Count | 18888.08 |
| 1987-1989 Wrangler, 1987-1989 Cherokee, 1st Gear [BA10 5 Speed] 12-34 Tooth Count | 18888.09 |
| 1987-1989 Wrangler, 1987-1989 Cherokee, Cluster Gear [BA10 5 Speed] | 18888.10 |
| 1987-1989 Wrangler, 1987-1989 Cherokee, Cluster Gear [BA10 5 Speed] | 18888.11 |
| 1987-1989 Wrangler, 1987-1989 Cherokee, 5th Gear [BA10 5 Speed] | 18888.12 |
| 1987-1989 Wrangler, 1987-1989 Cherokee, 5th Gear Synchronizer [BA10 5 Speed] | 18888.14 |
| 1987-1989 Wrangler, 1987-1989 Cherokee, Reverse Gear Kit [BA10 5 Speed], Includes: Gear, Reverse Rail & Reverse Idler | 18888.15 |
| 1987-1989 Wrangler, 1987-1989 Cherokee, Transmission Mount [BA10 5 Speed] | 18608.09 |
| 1987-1989 Wrangler, 1987-1989 Cherokee, Stabilizer Stud, Transmission Mount [BA10 5 Speeds] | 18608.05 |
| 1987-1989 Wrangler, 1987-1989 Cherokee, Stabilizer Bushing [BA10 5 Speeds], [2 Required] | 18608.06 |
| 1987-1989 Wrangler, 1987-1989 Cherokee, Polyurethane Stabilizer Bushing [BA10 5 Speeds], Red, Pair | 18608.07 |
| 1987-1989 Wrangler, 1987-1989 Cherokee, Polyurethane Stabilizer Bushing [BA10 5 Speeds], Black, Pair | 18608.08 |

K. 1984-2002 Aisin AX4 / AX5 5 Speed Transmissions

Part#

| | |
|--|----------|
| 1984-1996 Cherokee [2.5L], 1987-1995 Wrangler [2.5L] AX5 Transmission Assembly [5 Speed] | 18803.04 |
| 1997-2002 Wrangler [2.5L] AX5 Transmission Assembly [5 Speed] | 18803.05 |
| 1984-1987 Cherokee, Overhaul Kit [AX5 5 Speed] | 18806.08 |
| 1987-2002 Wrangler, 1988-2001 Cherokee, Overhaul Kit [AX5 5 Speed] | 18806.09 |
| 1984-2000 Cherokee, 1987-2002 Wrangler, Backup Light Switch [AX4 & AX5 5 Speed] NEW | 18886.01 |
| 1984-1993 Cherokee, 1987-1993 Wrangler, Front Bearing Retainer [AX4 & AX5 5 Speed] | 18886.02 |
| 1994-1999 Cherokee, 1994-2001 Wrangler, Front Bearing Retainer [AX4 & AX5 5 Speed] | 18886.03 |
| 1984-2001 Cherokee, 1987-2002 Wrangler, Front Bearing Retainer Seal [AX4 & AX5 5 Speed] | 18886.04 |
| 1984-2001 Cherokee, 1987-2002 Wrangler, Rear Output Seal [AX4 & AX5 5 Speed] | 18886.05 |
| 1984-1985 Cherokee, Front Input Shaft Seal [AX4 & AX5 5 Speed] | 18886.06 |
| 1986-2001 Cherokee, 1987-2002 Wrangler, Front Input Shaft Seal [AX4 & AX5 5 Speed] | 18886.07 |
| 1984-1985 Cherokee, Front Input Shaft [AX4 & AX5 5 Speed] | 18886.08 |
| 1986-1988 Cherokee, 1987-1988 Wrangler, Front Input Shaft [AX4 & AX5 5 Speed] | 18886.09 |
| 1989-2002 Wrangler, 1988-2001 Cherokee, Front Input Shaft [AX4 & AX5 5 Speed] | 18886.10 |
| 1984-2001 Cherokee, 1987-2002 Wrangler, 3rd & 4th Synchronizer Blocking Ring [AX4 & AX5 5 Speed], [2 Required] | 18886.11 |
| 1984-2001 Cherokee, 1987-2002 Wrangler, Input Shaft Needle bearing [AX4 & AX5 5 Speed], [14 Required] | 18886.12 |
| 1984-2001 Cherokee, 1987-2002 Wrangler, 3rd & 4th Synchronizer Spring [AX4 & AX5 5 Speed], [2 Required] | 18886.13 |
| 1984-1988 Cherokee, 1987-1988 Wrangler, 3rd & 4th Synchronizer Hub [AX4 & AX5 5 Speed] | 18886.14 |
| 1989-2001 Cherokee, 1989-2002 Wrangler, 3rd & 4th Synchronizer Hub [AX4 & AX5 5 Speed] | 18886.15 |
| 1984-1988 Cherokee, 1987-1988 Wrangler, 3rd & 4th Synchronizer Key [AX4 & AX5 5 Speed] | 18886.16 |
| 1989-2001 Cherokee, 1989-2002 Wrangler, 3rd & 4th Synchronizer Key [AX4 & AX5 5 Speed] | 18886.17 |
| 1984-1988 Cherokee, 1987-1988 Wrangler, 3rd & 4th Synchronizer Sleeve [AX4 & AX5 5 Speed] | 18886.18 |
| 1997-2001 Cherokee, 1997-2002 Wrangler, 3rd & 4th Synchronizer Sleeve [AX4 & AX5 5 Speed] | 18886.20 |
| 1989-2001 Cherokee, 1989-2002 Wrangler, 3rd Gear [AX4 & AX5 5 Speed] | 18886.22 |
| 1984-2001 Cherokee, 1987-2002 Wrangler, 3rd Gear Needle Bearing [AX4 & AX5 5 Speed] | 18886.23 |
| 1984-2001 Cherokee, 1987-2002 Wrangler, Main Shaft [AX4 & AX5 5 Speed] | 18886.24 |
| 1984-2001 Cherokee, 1987-2002 Wrangler, Main Shaft 1st Gear Pin [AX4 & AX5 5 Speed] | 18886.25 |
| 1987-2002 Wrangler, 2nd Gear Needle Bearing [AX4 & AX5 5 Speed] | 18886.26 |
| 1984-1996 Cherokee, 2nd Gear Needle Bearing [AX4 & AX5 5 Speed] | 18886.26 |
| 1984-1988 Cherokee, 1987-1988 Wrangler, 2nd Gear [AX4 & AX5 5 Speed] | 18886.27 |
| 1989-2001 Cherokee, 1989-2002 Wrangler, 2nd Gear [AX4 & AX5 5 Speed] | 18886.28 |



Aisin AX4/AX5
1987-3003 4cyl Wrangler
1984-2000 Cherokee

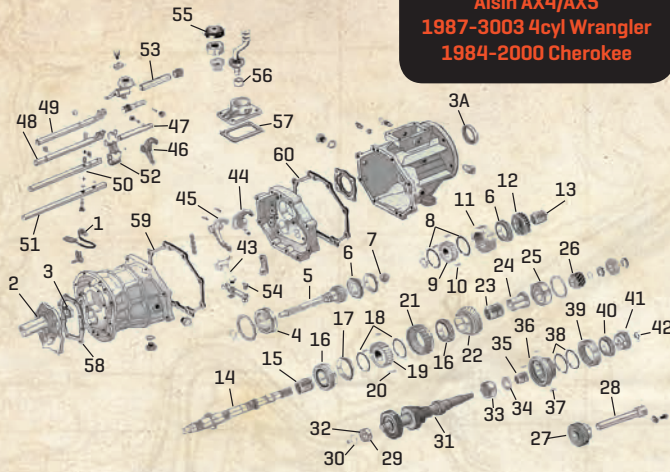

[K] 18806.08

[K] 18803.05

| K. 1984-2002 Aisin AX4 / AX5 5 Speed Transmissions (continued) | | Part# |
|--|---|----------|
| 17 | 1984-2001 Cherokee, 1987-2002 Wrangler, 1st & 2nd Synchronizer Blocking Ring [AX4 & AX5 5 Speed] | 18886.29 |
| 18 | 1984-2001 Cherokee, 1987-2002 Wrangler, 1st & 2nd Synchronizer Spring [AX4 & AX5 5 Speed], [2 Required] | 18886.30 |
| 19 | 1984-2001 Cherokee, 1987-2002 Wrangler, 1st & 2nd Synchronizer Hub [AX4 & AX5 5 Speed] | 18886.31 |
| 20 | 1984-2001 Cherokee, 1987-2002 Wrangler, 1st & 2nd Synchronizer Key Plate [AX4 & AX5 5 Speed] | 18886.32 |
| 21 | 1984-1997 Cherokee, 1987-1998 Wrangler, Reverse Gear [AX4 & AX5 5 Speed] | 18886.33 |
| 21 | 1999-2002 Wrangler, 1998-2000 Cherokee, Reverse Gear [AX4 & AX5 5 Speed] | 18886.34 |
| 22 | 1984-1988 Cherokee, 1987-1988 Wrangler, 1st Gear [AX4 & AX5 5 Speed] | 18886.35 |
| 22 | 1989-2001 Cherokee, 1989-2002 Wrangler, 1st Gear [AX4 & AX5 5 Speed] | 18886.36 |
| 23 | 1984-1988 Cherokee, 1987-1988 Wrangler, 1st Gear Needle Bearing [AX4 & AX5 5 Speed] | 18886.37 |
| 23 | 1989-2001 Cherokee, 1989-2002 Wrangler, 1st Gear Needle Bearing [AX4 & AX5 5 Speed] | 18886.38 |
| 24 | 1984-1988 Cherokee, 1987-1988 Wrangler, 1st Gear Race [AX4 & AX5 5 Speed] | 18886.39 |
| 24 | 1989-2001 Cherokee, 1989-2002 Wrangler, 1st Gear Race [AX4 & AX5 5 Speed] | 18886.40 |
| 25 | 1984-1988 Cherokee, 1987-1988 Wrangler, Main Shaft Rear Bearing [AX4 & AX5 5 Speed] | 18886.41 |
| 25 | 1989-2001 Cherokee, 1989-2002 Wrangler, Main Shaft Rear Bearing [AX4 & AX5 5 Speed] | 18886.42 |
| 26 | 1989-2001 Cherokee, 1989-2002 Wrangler, 5th Gear Main Shaft Side [AX4 & AX5 5 Speed] | 18886.43 |
| 27 | 1984-1997 Cherokee, 1987-1998 Wrangler, Reverse Idler Gear [AX4 & AX5 5 Speed] | 18886.44 |
| 27 | 1998-2000 Cherokee, 1999-2002 Wrangler, Reverse idler Gear [AX4 & AX5 5 Speed] | 18886.45 |
| 28 | 1984-1997 Cherokee, 1987-1998 Wrangler, Reverse Idler Shaft [AX4 & AX5 5 Speed] | 18886.46 |
| 29 | 1984-2001 Cherokee, 1987-2002 Wrangler, Cluster Gear Front Bearing [AX4 & AX5 5 Speed], [2 Required] | 18886.47 |
| 30 | 1984-2001 Cherokee, 1987-2002 Wrangler, Snap Ring [AX4 & AX5 5 Speed], 2.25mm | 18892.28 |
| 31 | 1984-1988 Cherokee, 1987-1988 Wrangler, Cluster Gear [AX4 & AX5 5 Speed] | 18886.48 |
| 31 | 1987-1999 Wrangler, 1989-1997 Cherokee, Reverse Idler Gear [AX4 & AX5 5 Speed] | 18886.49 |
| 31 | 1998-2000 Cherokee, Reverse Idler Gear [AX4 & AX5 5 Speed] | 18886.50 |
| 31 | 1984-1988 Cherokee, 1987-1988 Wrangler, Cluster Gear Nut [AX4 & AX5 5 Speed] | 18886.51 |
| 32 | 1987-1999 Wrangler, 1989-1997 Cherokee, Reverse Idler Gear [AX4 & AX5 5 Speed] | 18886.52 |
| 33 | 1984-1988 Cherokee, 1987-1988 Wrangler, Cluster Gear Rear Bearing [AX4 & AX5 5 Speed] | 18886.53 |
| 33 | 1989-2002 Wrangler, 1989-2001 Cherokee, Cluster Gear Rear Bearing [AX4 & AX5 5 Speed] | 18886.54 |
| 34 | 1987-1999 Wrangler, 1989-1997 Cherokee, Cluster Gear Thrush Washer [AX4 & AX5 5 Speed] | 18886.55 |
| 35 | 1987-1999 Wrangler, 1989-1997 Cherokee, 5th Gear Needle Bearing [AX4 & AX5 5 Speed] | 18886.56 |
| 36 | 1987-1999 Wrangler, 1989-1997 Cherokee, 5th Gear [AX4 & AX5 5 Speed], Cluster Gear Side | 18886.57 |
| 37 | 1987-1999 Wrangler, 1989-1997 Cherokee, 5th Gear Synchronizer Key Plate [AX4 & AX5 5 Speed] | 18886.58 |
| 38 | 1984-1998 Cherokee, 1987-1999 Wrangler, 5th Gear Synchronizer Spring [AX4 & AX5 5 Speed], [2 Required] | 18886.13 |
| 39 | 1989-1993 Cherokee, 1989-1993 Wrangler, 5th Gear Synchronizer Sleeve [AX4 & AX5 5 Speed] | 18886.60 |

| K. 1984-2002 Aisin AX4 / AX5 5 Speed Transmissions (continued) | | Part# |
|--|--|----------|
| 39 | 1994-2002 Wrangler, 1994-2001 Cherokee, 5th Gear Synchronizer Sleeve [AX4 & AX5 5 Speed] | 18886.61 |
| 40 | 1984-2001 Cherokee, 1987-2002 Wrangler, 5th Gear Synchronizer [AX4 & AX5 5 Speed] | 18886.11 |
| 41 | 1989-1993 Wrangler, 1989-1993 Cherokee, 5th Gear Spacer [AX4 & AX5 5 Speed] | 18886.63 |
| 42 | 1984-2001 Cherokee, 1987-2002 Wrangler, 5th Gear Snap Ring [AX4 & AX5 5 Speed], 2.73mm | 18892.08 |
| 42 | 1984-2001 Cherokee, 1987-2002 Wrangler, 5th Gear Snap Ring [AX4 & AX5 5 Speed], 3.03mm | 18892.13 |
| 43 | 1984-2001 Cherokee, 1987-2002 Wrangler, Reverse Shift Fork [AX4 & AX5 5 Speed], 3.03mm | 18886.64 |
| 43 | 1984-1989 Cherokee, 1987-1989 Wrangler, 1st & 2nd Gear Shift Fork [AX4 & AX5 5 Speed] | 18886.66 |
| 44 | 1990-1999 Wrangler, 1990-1999 Cherokee, 2nd & 3rd Gear Shift Fork [AX4 & AX5 5 Speed] | 18886.67 |
| 45 | 1984-2001 Cherokee, 1987-2002 Wrangler, 3rd & 4th Gear Shift Fork & Sleeve Kit [AX4 & AX5 5 Speed] | 18886.68 |
| 46 | 1987-1993 Wrangler, 1987-1993 Cherokee, 5th Gear Shift Fork [AX4 & AX5 5 Speed] | 18886.69 |
| 46 | 1993-2002 Wrangler, 1993-2001 Cherokee, 5th Gear Shift Fork [AX4 & AX5 5 Speed] | 18886.70 |
| 47 | 1984-2001 Cherokee, 1987-2002 Wrangler, Reverse Gear Shift Shaft [AX4 & AX5 5 Speed] | 18886.71 |
| 48 | 1984-1999 Cherokee, 1987-1999 Wrangler, 5th Gear Shift Shaft [AX4 & AX5 5 Speed] | 18886.72 |
| 49 | 1987-2002 Wrangler, 1987-2001 Cherokee, 3rd & 4th Gear Shaft [AX4 & AX5 5 Speed] | 18886.73 |
| 50 | 1984-1988 Cherokee, 1987-1988 Wrangler, Reverse Gear Shaft [AX4 5 Speed] | 18886.74 |
| 50 | 1988-1999 Wrangler, 1988-1999 Cherokee, Reverse Gear Shaft [AX5 5 Speed] | 18886.75 |
| 51 | 1987-1999 Wrangler, 1987-1999 Cherokee, 5th Gear Shaft [AX5 5 Speed] | 18886.76 |
| 52 | 1984-1996 Cherokee, 1987-1996 Wrangler, Reverse Shift Head [AX4 & AX5 5 Speed] | 18886.77 |
| 52 | 1997-2002 Wrangler, 1997-2001 Cherokee, Reverse Shift Head [AX4 & AX5 5 Speed] | 18886.78 |
| 53 | 1987-1999 Wrangler, 1987-1999 Cherokee, Shift Lever Shaft [AX5 5 Speed] | 18886.79 |
| 53 | 1987-1999 Wrangler, 1987-1999 Cherokee, Reverse Right Hand Shift Pin [AX5 5 Speed] | 18886.80 |
| 53 | 1987-1999 Wrangler, 1987-1999 Cherokee, Reverse Left Hand Shift Pin [AX5 5 Speed] | 18886.81 |
| 54 | 1984-2001 Cherokee, 1987-2002 Wrangler, Reverse Ball [AX4 & AX5 5 Speed], 2.73mm | 18886.82 |
| 54 | 1984-2001 Cherokee, 1987-2002 Wrangler, Oil Filler Tube [AX4 & AX5 5 Speed], 2.73mm | 18886.83 |
| 54 | 1984-2001 Cherokee, 1987-2002 Wrangler, Shift Arm Tube [AX4 & AX5 5 Speed], 2.73mm | 18886.84 |
| 55 | 1987-1999 Wrangler, 1987-1999 Cherokee, Shifter Boot [AX4 & AX5 5 Speed] | 18886.85 |
| 56 | 1987-1999 Wrangler, 1987-1999 Cherokee, Shifter Cup Bushing [AX4 & AX5 5 Speed] | 18886.86 |
| 57 | 1987-1999 Wrangler, 1987-1999 Cherokee, Shifter Cover Gasket [AX4 & AX5 5 Speed] | 18886.87 |
| 57 | 1987-1995 Wrangler, Transmission Mount, [AX4 & AX5 5 Speed] | 18608.09 |
| 57 | 1997-2006 Wrangler, Transmission Mount, [AX4 & AX5 5 Speed] | 18608.10 |
| 57 | 1997-2006 Wrangler, Polyurethane Transmission Mount, [AX4 & AX5 5 Speed], Red | 18608.11 |
| 57 | 1997-2006 Wrangler, Polyurethane Transmission Mount, [AX4 & AX5 5 Speed], Black | 18608.12 |
| 57 | 1987-1996 Wrangler, Transmission Mount, [AX4 & AX5 5 Speed] | 19005.03 |
| 57 | 1984-2001 Cherokee, 1987-2002 Wrangler, Gasket Set [AX4 & AX5 5 Speed] | 18804.06 |
| 58 | 1984-2001 Cherokee, 1987-2002 Wrangler, Shifter Cover Gasket [AX4 & AX5 5 Speed] | 18886.89 |
| 59 | 1984-2001 Cherokee, 1987-2002 Wrangler, Front Intermediate Gasket [AX4 & AX5 5 Speed] | 18886.90 |
| 60 | 1984-2001 Cherokee, 1987-2002 Wrangler, Adapter Plate Gasket [AX4 & AX5 5 Speed] | 18886.91 |

All images are subject to be representative. More detailed information is available online.

1984-2001 Aisin AX15 5 Speed Transmissions

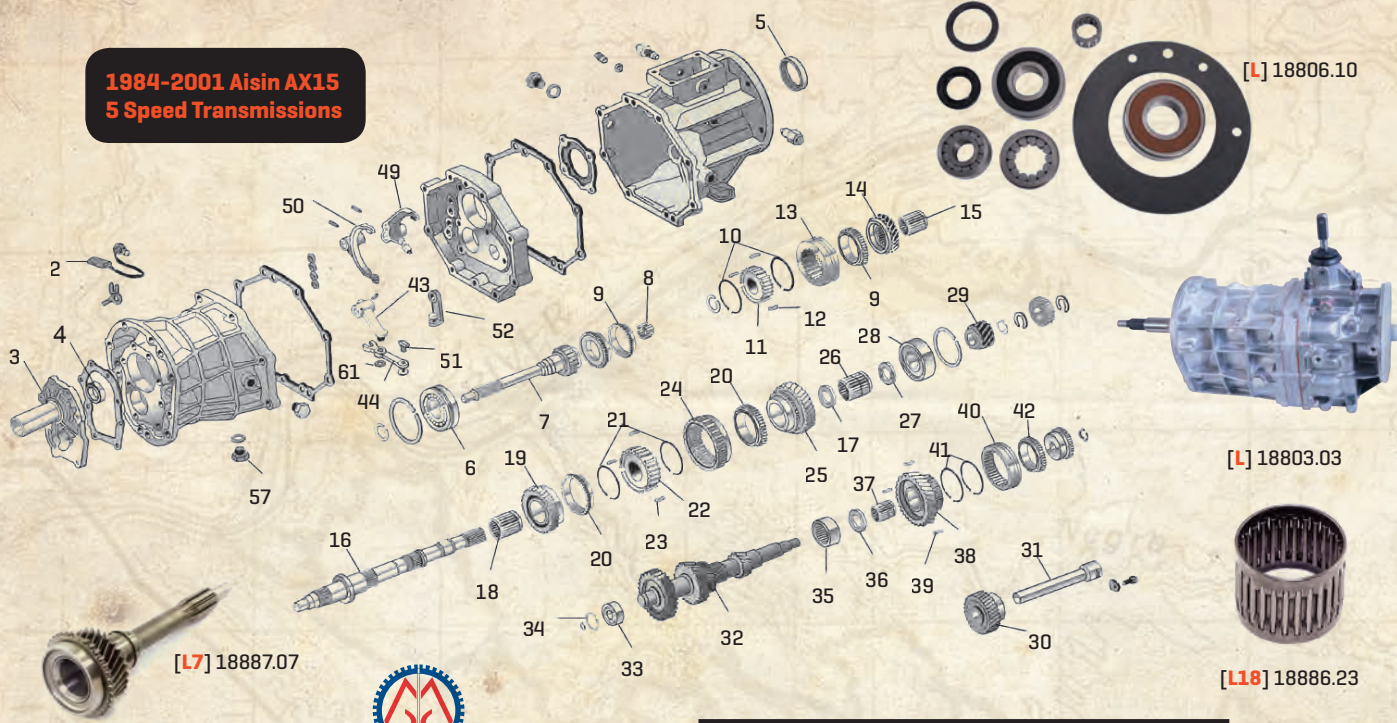

L. 1984-2001 Aisin AX15 5 Speed Transmissions

Part#

| | |
|--|----------|
| 1984-1999 Wrangler, 1984-1999 Cherokee, AX15 Transmission Assembly [5 Speed] | 18803.03 |
| 1 1989-1999 Wrangler, 1989-1999 Cherokee, Overhaul Kit [AX15 5 Speed] | 18806.10 |
| 2 1987-1999 Wrangler, 1987-1999 Cherokee, Backup Light Switch [AX15 5 Speed] NEW | 18886.01 |
| 3 1987-1991 Wrangler, 1987-1991 Cherokee, Front Bearing Retainer [AX15 5 Speed] | 18887.01 |
| 3 1992-1993 Wrangler, 1992-1993 Cherokee, Front Bearing Retainer [AX15 5 Speed] | 18887.02 |
| 3 1994-1999 Wrangler, 1994-1999 Cherokee, Front Bearing Retainer [AX15 5 Speed] | 18887.03 |
| 4 1989-1999 Wrangler, 1989-1999 Cherokee, Front Bearing Retainer Oil Seal [AX15 5 Speed] | 18887.04 |
| 5 1989-1999 Wrangler [4WD], 1989-1999 Cherokee [4WD], Rear Adapter Oil Seal [AX15 5 Speed] | 18886.05 |
| 6 1989-1999 Wrangler, 1989-1999 Cherokee, Input Shaft Bearing Retainer [AX15 5 Speed] | 18887.06 |
| 7 1989-1999 Wrangler, 1989-1999 Cherokee, Input Shaft Bearing Retainer [AX15 5 Speed] | 18887.07 |
| 7 1987-1991 Wrangler, 1987-1991 Cherokee, Input Shaft [AX15 5 Speed] | 18887.08 |
| 7 1992-1993 Wrangler, 1992-1993 Cherokee, Input Shaft [AX15 5 Speed] | 18887.09 |
| 8 1994-1999 Wrangler, 1994-1999 Cherokee, Input Shaft [AX15 5 Speed] | 18887.10 |
| 9 1989-1999 Wrangler, 1989-1997 Cherokee, 1999 Cherokee, 3rd & 4th Gear Synchronizer Ring [AX15 5 Speed], [2 Required] | 18887.11 |
| 9 1998-1999 Cherokee, 3rd & 4th Gear Synchronizer Blocking Ring [AX15 5 Speed], [2 Required] | 18887.12 |
| 10 1989-1999 Wrangler, 1989-1999 Cherokee, 3rd & 4th Gear Synchronizer Spring [AX15 5 Speed], [2 Required] | 18887.13 |
| 11 1989-1999 Wrangler, 1989-1999 Cherokee, 3rd & 4th Gear Synchronizer Hub [AX15 5 Speed] | 18887.14 |
| 12 1989-1999 Wrangler, 1989-1999 Cherokee, 3rd & 4th Gear Synchronizer Key Plate [AX15 5 Speed], [3 Required] | 18887.15 |
| 13 1989-1997 Wrangler, 1989-1997 Cherokee, 3rd & 4th Gear Synchronizer Sleeve [AX15 5 Speed] | 18887.16 |
| 13 1998-1999 Wrangler, 1998-1999 Cherokee, 3rd & 4th Gear Synchronizer Sleeve [AX15 5 Speed] | 18887.17 |
| 14 1989-1997 Wrangler, 1989-1997 Cherokee, 3rd Gear [AX15 5 Speed] | 18887.18 |
| 14 1998-1999 Wrangler, 1998-1999 Cherokee, 3rd Gear [AX15 5 Speed] | 18887.19 |
| 15 1989-1999 Wrangler, 1989-1999 Cherokee, 3rd Gear Needle Bearing [AX15 5 Speed] | 18887.20 |
| 16 1987-1999 Wrangler, 1987-1999 Cherokee, Mainshaft [AX15 5 Speed], 16-1/8" | 18887.21 |
| 17 1987-1999 Wrangler, 1987-1999 Cherokee, Mainshaft 1st Gear Spacer [AX15 5 Speed] | 18887.22 |

L. 1984-2001 Aisin AX15 5 Speed Transmissions (continued)

Part#

| | |
|--|----------|
| 18 1989-1999 Wrangler, 1989-1999 Cherokee, 2nd Gear Needle Bearing [AX15 5 Speed] | 18887.23 |
| 19 1989-1991 Wrangler, 1989-1991 Cherokee, 2nd Gear [AX15 5 Speed] | 18887.24 |
| 19 1992-1999 Wrangler, 1992-1999 Cherokee, 2nd Gear [AX15 5 Speed] | 18887.25 |
| 20 1987-1999 Wrangler, 1987-1999 Cherokee, 1st & 2nd Gear Synchronizer Ring [AX15 5 Speed], [2 Required] | 18887.26 |
| 21 1987-1999 Wrangler, 1987-1999 Cherokee, 1st & 2nd Gear Synchronizer Spring [AX15 5 Speed] | 18887.27 |
| 22 1987-1999 Wrangler, 1987-1999 Cherokee, 1st & 2nd Gear Synchronizer Hub [AX15 5 Speed] | 18887.28 |
| 23 1987-1999 Wrangler, 1987-1999 Cherokee, 1st & 2nd Gear Synchronizer Key [AX15 5 Speed], [3 Required] | 18887.29 |
| 24 1987-1999 Wrangler, 1987-1999 Cherokee, Reverse Gear [AX15 5 Speed] | 18887.30 |
| 25 1989-1992 Wrangler, 1989-1992 Cherokee, 1st Gear [AX15 5 Speed] | 18887.31 |
| 25 1993-1999 Wrangler, 1993-1999 Cherokee, 1st Gear [AX15 5 Speed] | 18887.32 |
| 26 1987-1999 Wrangler, 1987-1999 Cherokee, 1st Gear Needle Bearing [AX15 5 Speed] | 18887.33 |
| 27 1987-1999 Wrangler, 1987-1999 Cherokee, 1st Gear Thrust Washer [AX15 5 Speed] | 18887.34 |
| 28 1987-1999 Wrangler, 1987-1999 Cherokee, Main Shaft Rear Bearing [AX15 5 Speed] | 18887.35 |
| 29 1987-1999 Wrangler, 1987-1999 Cherokee, 5th Gear [AX15 5 Speed], Main Shaft Side | 18887.36 |
| 30 1987-1999 Wrangler, 1987-1999 Cherokee, Reverse Idler Gear [AX15 5 Speed] | 18887.37 |
| 31 1987-1999 Wrangler, 1987-1999 Cherokee, Reverse Idler Shaft [AX15 5 Speed] | 18887.38 |
| 32 1987-1991 Wrangler, 1987-1991 Cherokee, Cluster Gear [AX15 5 Speed] | 18887.39 |
| 32 1992-1999 Wrangler, 1992-1999 Cherokee, Cluster Gear [AX15 5 Speed] | 18887.40 |
| 33 1987-1999 Wrangler, 1987-1999 Cherokee, Cluster Gear Front Bearing [AX15 5 Speed] | 18887.41 |
| 34 1987-1999 Wrangler, 1987-1999 Cherokee, Cluster Gear Front Bearing Snap Ring [AX15 5 Speed] | 18887.42 |
| 35 1987-1999 Wrangler, 1987-1999 Cherokee, Cluster Gear Rear Bearing [AX15 5 Speed] | 18887.43 |
| 36 1987-1999 Wrangler, 1987-1999 Cherokee, Cluster Gear Rear Thrust Washer [AX15 5 Speed] | 18887.44 |
| 37 1987-1999 Wrangler, 1987-1999 Cherokee, 5th Gear Needle Bearing [AX15 5 Speed] | 18887.45 |
| 38 1987-1992 Wrangler, 1987-1992 Cherokee, 5th Gear [AX15 5 Speed], Cluster Gear Side | 18887.48 |
| 38 1992-1999 Wrangler, 1992-1999 Cherokee, 5th Gear [AX15 5 Speed], Cluster Gear Side | 18887.49 |
| 39 1987-1992 Wrangler, 1987-1992 Cherokee, 5th Gear Synchronizer Key [AX15 5 Speed], [3 Required] | 18887.51 |
| 39 1992-1999 Wrangler, 1992-1999 Cherokee, 5th Gear Synchronizer Key [AX15 5 Speed], [3 Required] | 18887.52 |
| 39 1987-1999 Wrangler, 1987-1999 Cherokee, 5th Gear Spacer [AX15 5 Speed], Cluster Gear Side | 18887.50 |

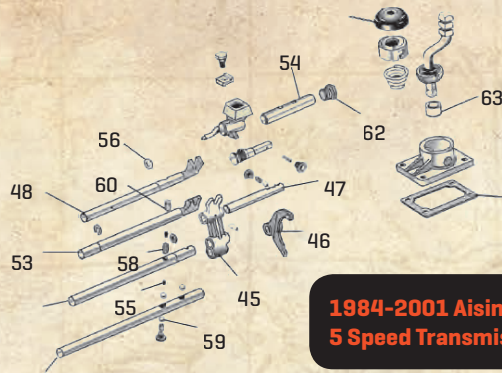

1984-2001 Aisin AX15 5 Speed Transmissions



[M] 19001.01

L. 1984-2001 Aisin AX15 5 Speed Transmissions (continued)

| | Part# | |
|----|---|----------|
| 40 | 1987-1999 Wrangler, 1987-1999 Cherokee, 5th Gear Synchronizer Sleeve [AX15 5 Speed], Cluster Gear Side | 18887.53 |
| 41 | 1987-1992 Wrangler, 1987-1992 Cherokee, 5th Gear Synchronizer Spring [AX15 5 Speed], [2 Required] | 18887.27 |
| 41 | 1992-1999 Wrangler, 1992-1999 Cherokee, 5th Gear Synchronizer Spring [AX15 5 Speed], [2 Required] | 18887.55 |
| 42 | 1987-1992 Wrangler, 1987-1992 Cherokee, 5th Gear Synchronizer Ring [AX15 5 Speed] | 18887.11 |
| 42 | 1992-1999 Wrangler, 1992-1999 Cherokee, 5th Gear Synchronizer Ring [AX15 5 Speed] | 18887.57 |
| 43 | 1987-1999 Wrangler, 1987-1999 Cherokee, Reverse Shift Fork [AX15 5 Speed] | 18887.58 |
| 44 | 1987-1999 Wrangler, 1987-1999 Cherokee, Reverse Shift Arm [AX15 5 Speed] | 18887.59 |
| | 1987-1999 Wrangler, 1987-1999 Cherokee, Reverse Gear Shift Shaft [AX15 5 Speed] | 18887.60 |
| | 1987-1999 Wrangler, 1987-1999 Cherokee, 5th Gear Shift Shaft [AX15 5 Speed] | 18887.61 |
| 45 | 1987-1999 Wrangler, 1987-1999 Cherokee, Reverse Shift Head [AX15 5 Speed] | 18887.62 |
| 46 | 1987-1999 Wrangler, 1987-1999 Cherokee, 5th Gear Shift Fork [AX15 5 Speed] | 18887.63 |
| 47 | 1987-1999 Wrangler, 1987-1999 Cherokee, Rear Reverse Gear Shift Shaft [AX15 5 Speed] | 18887.64 |
| 48 | 1987-1999 Wrangler, 1987-1999 Cherokee, 3rd & 4th Gear Shift Shaft [AX15 5 Speed] | 18887.65 |
| 49 | 1987-1999 Wrangler, 1987-1999 Cherokee, 1st & 2nd Gear Shift Shaft [AX15 5 Speed] | 18887.66 |
| 50 | 1987-1999 Wrangler, 1987-1999 Cherokee, 3rd & 4th Gear Shift Shaft [AX15 5 Speed] | 18887.67 |
| 51 | 1987-1999 Wrangler, 1987-1999 Cherokee, Shifter Arm Shoe [AX15 5 Speed] | 18887.68 |
| 52 | 1987-1999 Wrangler, 1987-1999 Cherokee, Shifting Bracket [AX15 5 Speed] | 18887.69 |
| 53 | 1987-1999 Wrangler, 1987-1999 Cherokee, 1st Gear Shift Shaft Bracket [AX15 5 Speed] | 18887.70 |
| 54 | 1987-1999 Wrangler, 1987-1999 Cherokee, Shift Lever Shaft [AX15 5 Speed] | 18887.71 |
| 55 | 1987-1999 Wrangler, 1987-1999 Cherokee, Reverse Pin [AX15 5 Speed] | 18887.72 |
| 56 | 1987-1999 Wrangler, 1987-1999 Cherokee, Shift Lever Snap Ring [AX15 5 Speed], 1.5mm | 18887.73 |
| 57 | 1987-1999 Wrangler, 1987-1999 Cherokee, Drain Plug [AX15 5 Speed] | 18887.74 |
| 58 | 1987-1999 Wrangler, 1987-1999 Cherokee, Reverse Gear Shift Shaft Roller [AX15 5 Speed] | 18887.75 |
| 59 | 1987-1999 Wrangler, 1987-1999 Cherokee, Shift Shaft Ball [AX15 5 Speed] | 18887.76 |
| 60 | 1987-1999 Wrangler, 1987-1999 Cherokee, 1st Gear Shift Shaft Roller [AX15 5 Speed] | 18887.77 |
| 61 | 1987-1999 Wrangler, 1987-1999 Cherokee, Reverse Arm Ring Retainer [AX15 5 Speed] | 18887.78 |
| 62 | 1987-1999 Wrangler, 1987-1999 Cherokee, Shift Lever Shaft Plug [AX15 5 Speed] | 18887.80 |
| 63 | 1987-1999 Wrangler, 1987-1999 Cherokee, Shift Cup Bushing [AX15 5 Speed] | 18887.86 |
| | 1987-2006 Wrangler, 1987-2001 Cherokee, Transmission Mount [AX15 5 Speed] | 18608.09 |
| | 1987-1989 Wrangler, 1987-1989 Cherokee, Stabilizer Stud, Transmission Mount [AX15 5 Speeds] | 18608.10 |
| | 1987-1989 Wrangler, 1987-1989 Cherokee, Stabilizer Bushing [AX15 5 Speeds], [2 Required] | 18608.11 |
| | 1987-1989 Wrangler, 1987-1989 Cherokee, Polyurethane Stabilizer Bushing [AX15 5 Speeds], Red, Pair | 18608.12 |
| | 1987-1989 Wrangler, 1987-1989 Cherokee, Gasket Set [AX15 5 Speeds], Black, Pair | 18804.06 |

M. Automatic Transmission Rebuild Kits

| | Part# |
|---|----------|
| 1987-2003 Wrangler [2.4L, 2.5L & 4.0L], Rebuild Kit [TF6 Transmission] | 19001.04 |
| 1987-2001 Cherokee [2.5L & 4.0L], Rebuild Kit [AW4 Transmission] | 19001.03 |
| 1993-2004 Grand Cherokee [4.0L], Rebuild Kit [A500 Transmission] | 19001.01 |
| 1993-1998 Grand Cherokee [5.2L & 5.9L], Rebuild Kit [A518 Transmission] | 19001.02 |
| 1999-2004 Grand Cherokee [4.7L], 2002-2004 [2.4L & 3.7L] Rebuild Kit [45RFE Transmission] | 19001.05 |

N. Automatic Transmission Filters

| | Part# |
|--|----------|
| 1984-2000 Cherokee [A904, A999 & 30RH], 1990-2003 Wrangler [A999, 30RH & 32RH], 1993-1998 Grand Cherokee [42RE, 46RH, & 44RE], 1990-2001 Grand Wagoneer [SJ] [A727], Automatic Transmission Filter | 19003.05 |
| 1987-2001 Cherokee [AW4], 1993 Grand Cherokee [AW4], Automatic Transmission Filter | 19003.07 |
| 1998-2004 Grand Cherokee [42RE, 44RE & 46RE], Automatic Transmission Filter | 19003.01 |
| 1999-2010 Grand Cherokee [45RF w/ 4WD, 45RF, 2DGQ], 2002-2007 Liberty [45RF & 45RFE w/ 4WD], Commander [45RF, 2DGQ], 2007-2010 Wrangler [2DGQ], Automatic Transmission Filter NEW | 19003.02 |

O. Transmission Mounts

| | Part# |
|---|----------|
| 1984-1999 Cherokee [2.5L 2.8L & 4.0L], Transmission Mount [Automatic] | 19005.01 |
| 1985-1986 Cherokee [2.1L Diesel], Transmission Mount [Manual] | 19005.03 |
| 1985-1986 Cherokee [2.1L Diesel], Transmission Mount [Manual] | 19005.03 |
| 2000-2001 Cherokee [2.5L & 4.0L], Transmission Mount [Automatic] | 19005.04 |
| 1994-1995 Grand Cherokee [4.0L], Transmission Mount [Automatic] | 19005.05 |
| 1996 Grand Cherokee [4.0L], Transmission Mount [Automatic] | 19005.06 |
| 1997-1998 Grand Cherokee [4.0L], Transmission Mount [Automatic] | 19005.07 |
| 1993-1998 Grand Cherokee [5.2L], 1998 Grand Cherokee [5.9L], Transmission Mount [Automatic] | 19005.08 |
| 1999 Grand Cherokee [4.0L, 4WD], Transmission Mount [Automatic] | 19005.09 |
| 1999 Grand Cherokee [4.0L, 2WD], Transmission Mount [Automatic] | 19005.10 |
| 2000-2004 Grand Cherokee [4.0L, 2WD], Transmission Mount [Automatic] | 19005.11 |
| 2000 Grand Cherokee [4.0L, 4WD], Transmission Mount [Automatic] | 19005.12 |
| 2001-2004 Grand Cherokee [4.0L, 4WD], Transmission Mount [Automatic] | 19005.13 |
| 1999-2004 Grand Cherokee [4.7L, 4WD], Transmission Mount [Automatic] | 19005.14 |

Transmission - T4

P. 1982-1986 Warner T4 4 Speed Transmission

Part#

| | | |
|----|--|----------|
| | 1982-1983 CJ5, 1982-1986 CJ7, 1982-1986 CJ8, <i>Transmission Overhaul Kit</i> [T4 4 Speed] NEW | 18801.06 |
| | RTV Silicon [3 oz] | 19201.01 |
| | 1982-1983 CJ5, 1982-1986 CJ7, 1982-1986 CJ8, Small Parts Kits, [T4 4 Speed] | 18805.07 |
| 1 | 1982-1983 CJ5, 1982-1986 CJ7, 1982-1986 CJ8, Front Input Shaft Bearing, [T4 4 Speed] | 16536.15 |
| 2 | 1982-1983 CJ5, 1982-1986 CJ7, 1982-1986 CJ8, Rear Main Shaft Bearing, [T4 4 Speed] | 18885.01 |
| 3 | 1982-1983 CJ5, 1982-1986 CJ7, 1982-1986 CJ8, Front Input Shaft Bearing Retainer, [T4 4 Speed] | 18885.02 |
| 4 | 1982-1983 CJ5, 1982-1986 CJ7, 1982-1986 CJ8, Main Drive Oil Seal Retainer, [T4 4 Speed] | 18885.03 |
| 5 | 1982-1983 CJ5, 1982-1986 CJ7, 1982-1986 CJ8, Input Shaft With 4th Gear [T4 4 Speed], 21 Tooth Gear, 10 Spline | 18885.04 |
| 6 | 1982-1983 CJ5, 1982-1986 CJ7, 1982-1986 CJ8, Main Shaft With 1St & 2Nd Gear Synchronizer, [T4 4 Speed], Models Without 1St Gear Needle Bearing | 18885.06 |
| | 1982-1983 CJ5, 1982-1986 CJ7, 1982-1986 CJ8, Main Shaft With 1St & 2Nd Gear Synchronizer, [T4 4 Speed], Models With 1St Gear Needle Bearing | 18885.07 |
| 7 | 1982-1983 CJ5, 1982-1986 CJ7, 1982-1986 CJ8, Rear Output Shaft Oil Seal [T4 4 Speed] | 18885.08 |
| 8 | 1982-1983 CJ5, 1982-1986 CJ7, 1982-1986 CJ8, 3rd & 4th Gear Synchronizer Assembly [T4 4 Speed] | 18885.09 |
| 9 | 1982-1983 CJ5, 1982-1986 CJ7, 1982-1986 CJ8, 3rd & 4th Gear Synchronizer Blocking Ring [T4 4 Speed] | 18885.10 |
| 10 | 1982-1983 CJ5, 1982-1986 CJ7, 1982-1986 CJ8, 3rd Gear [T4 4 Speed], 27 Tooth | 18885.11 |
| 11 | 1982-1983 CJ5, 1982-1986 CJ7, 1982-1986 CJ8, 1st & 2nd Gear Synchronizer Blocking Ring [T4 4 Speed], [2 Required] | 18885.14 |
| | 1982-1983 CJ5, 1982-1986 CJ7, 1982-1986 CJ8, Front Cluster Bearing [T4 4 Speed] NEW | 18885.18 |
| 12 | 1982-1983 CJ5, 1982-1986 CJ7, 1982-1986 CJ8, Cluster Gear Kit, [T4 4 Speed], Includes 3rd Gear | 18885.16 |
| 13 | 1982-1983 CJ5, 1982-1986 CJ7, 1982-1986 CJ8, Rear Cluster Gear Bearing, [T4 4 Speed] | 16536.22 |



P. 1982-1986 Warner T4 4 Speed Transmission Cont.

Part#

| | | |
|----|--|----------|
| 14 | 1982-1983 CJ5, 1982-1986 CJ7, 1982-1986 CJ8, Reverse Idler Gear [T4 4 Speed], With Bushing | 18885.26 |
| | 1982-1983 CJ5, 1982-1986 CJ7, 1982-1986 CJ8, Bellhousing [T4 4 Speed] | 16916.02 |
| | 1982-1983 CJ5, 1982-1986 CJ7, 1982-1986 CJ8, Shifter Boot, [T4 4 Speed] | 18806.03 |
| | 1982-1983 CJ5, 1982-1986 CJ7, 1982-1986 CJ8, Shifter Knob [T4 4 Speed] | 18607.03 |
| | 1982-1983 CJ5, 1982-1986 CJ7, 1982-1986 CJ8, Shifter Knob Insert [T4 4 Speed] | 18884.33 |
| | 1982-1983 CJ5, 1982-1986 CJ7, 1982-1986 CJ8, Shifter Knob Lock Nut [T4 4 Speed] | 18607.05 |
| | 1982-1983 CJ5, 1982-1986 CJ7, 1982-1986 CJ8, Transfer Case Mount [T4 4 Speeds] | 18608.02 |
| | 1982-1983 CJ5, 1982-1986 CJ7, 1982-1986 CJ8, Polyurethane Mount [T4 4 Speeds], Red UPGRADE | 18608.03 |
| | 1982-1983 CJ5, 1982-1986 CJ7, 1982-1986 CJ8, Polyurethane Mount [T4 4 Speeds], Black UPGRADE | 18608.04 |
| | 1982-1983 CJ5, 1982-1986 CJ7, 1982-1986 CJ8, Stabilizer Stud, Transmission Mount [T4 4 Speeds] | 18608.05 |
| | 1982-1983 CJ5, 1982-1986 CJ7, 1982-1986 CJ8, Stabilizer Bushing [T4 4 Speeds], [2 Required] | 18608.06 |
| | 1982-1983 CJ5, 1982-1986 CJ7, 1982-1986 CJ8, Polyurethane Stabilizer Bushing [T4 4 Speeds], Red, Pair UPGRADE | 18608.07 |
| | 1982-1983 CJ5, 1982-1986 CJ7, 1982-1986 CJ8, Polyurethane Stabilizer Bushing [T4 4 Speeds], Black, Pair UPGRADE | 18608.08 |
| | 1982-1983 CJ5, 1982-1986 CJ7, 1982-1986 CJ8, Shifter Boot [T4 4 Speed] | 18885.30 |
| | 1982-1983 CJ5, 1982-1986 CJ7, 1982-1986 CJ8, Shifter Lever Kit [T4 4 Speed] | 18885.31 |
| | 1982-1983 CJ5, 1982-1986 CJ7, 1982-1986 CJ8, Shifter Handle Clip [T4 4 Speed] | 18885.32 |
| | 1982-1983 CJ5, 1982-1986 CJ7, 1982-1986 CJ8, Shifter Handle Insulator [T4 4 Speed] | 18885.33 |
| | 1982-1983 CJ5, 1982-1986 CJ7, 1982-1986 CJ8, Shifter Lever [T4 4 Speed] | 18885.34 |



Warner T4 4-Speed 1982-1986 CJ

Q. 1982-1986 Warner T5 5 Speed Transmission

Part#

| | | |
|-----|--|----------|
| | 1982-1983 CJ5, 1982-1986 CJ7, 1982-1986 CJ8, <i>Overhaul Kit</i> [T5 5 Speed], Includes Front & Rear Bearings, Gaskets & Seals Kit, Small Parts Kits | 18806.07 |
| | RTV Silicon [3 oz] | 19201.01 |
| | 1982-1983 CJ5, 1982-1986 CJ7, 1982-1986 CJ8, Small Parts Kits [T5 5 Speed] | 18805.07 |
| 1 | 1982-1983 CJ5, 1982-1986 CJ7, 1982-1986 CJ8, Front Input Shaft Bearing [T5 5 Speed] | 16536.15 |
| 2 | 1982-1983 CJ5, 1982-1986 CJ7, 1982-1986 CJ8, Rear Main Shaft Bearing [T5 5 Speed] | 18885.01 |
| 3 | 1982-1983 CJ5, 1982-1986 CJ7, 1982-1986 CJ8, Front Input Shaft Bearing Retainer [T5 5 Speed] | 18885.02 |
| 4 | 1982-1983 CJ5, 1982-1986 CJ7, 1982-1986 CJ8, Rear Main Shaft Bearing Retainer [T5 5 Speed] | 18885.03 |
| 5 | 1982-1983 CJ5, 1982-1986 CJ7, 1982-1986 CJ8, Input Shaft With 4th Gear [T5 5 Speed], 21 Tooth, 10 Spline | 18885.04 |
| 6 | 1982-1983 CJ5, 1982-1986 CJ7, 1982-1986 CJ8, Main Shaft With 1St & 2Nd Gear Synchronizer, [T5 5 Speed], Models Without 1St Gear Needle Bearing | 18885.06 |
| | 1982-1983 CJ5, 1982-1986 CJ7, 1982-1986 CJ8, Rear Output Shaft Oil Seal [T5 5 Speed] | 18885.08 |
| 7 | 1982-1983 CJ5, 1982-1986 CJ7, 1982-1986 CJ8, 3rd & 4th Gear Synchronizer Assembly [T5 5 Speed] | 18885.09 |
| 8 | 1982-1983 CJ5, 1982-1986 CJ7, 1982-1986 CJ8, 3rd & 4th Gear Synchronizer Blocking Ring [T5 5 Speed] | 18885.10 |
| 9 | 1982-1983 CJ5, 1982-1986 CJ7, 1982-1986 CJ8, 3rd Gear [T5 5 Speed], 27 Tooth | 18885.11 |
| 10 | 1982-1983 CJ5, 1982-1986 CJ7, 1982-1986 CJ8, 1st & 2nd Gear Synchronizer Blocking Ring [T5 5 Speed], [2 Required] | 18885.14 |
| 11 | 1982-1983 CJ5, 1982-1986 CJ7, 1982-1986 CJ8, <i>Cluster Gear Kit</i> , [T5 5 Speed], Includes 3rd Gear | 18885.17 |
| 11A | 1982-1983 CJ5, 1982-1986 CJ7, 1982-1986 CJ8, Front Cluster Gear Bearing [T5 5 Speed] | 18885.19 |
| 12 | 1982-1983 CJ5, 1982-1986 CJ7, 1982-1986 CJ8, Rear Cluster Gear Bearing [T5 5 Speed] | 16536.22 |
| 13 | 1982-1983 CJ5, 1982-1986 CJ7, 1982-1986 CJ8, 5th Gear Synchronizer Blocking Ring [T5 5 Speed] | 18885.23 |

Q. 1982-1986 Warner T5 5 Speed Transmission Cont.

Part#

| | | |
|----|---|----------|
| 14 | 1982-1983 CJ5, 1982-1986 CJ7, 1982-1986 CJ8, Reverse Gear Idler [T5 5 Speed], With Bushing | 18885.26 |
| | 1982-1983 CJ5, 1982-1986 CJ7, 1982-1986 CJ8, Bellhousing [T5 5 Speed], With Bushing | 16916.02 |
| | 1982-1983 CJ5, 1982-1986 CJ7, 1982-1986 CJ8, Shifter Boot [T5 5 Speed], With Bushing | 18806.03 |
| | 1982-1983 CJ5, 1982-1986 CJ7, 1982-1986 CJ8, Shifter Knob [T5 5 Speed], With Bushing | 18607.03 |
| | 1982-1983 CJ5, 1982-1986 CJ7, 1982-1986 CJ8, Shifter Knob Insert [T5 5 Speed], With Bushing | 18885.28 |
| | 1982-1983 CJ5, 1982-1986 CJ7, 1982-1986 CJ8, Shifter Knob Lock Nut [T5 5 Speed], With Bushing | 18607.05 |
| | 1982-1983 CJ5, 1982-1986 CJ7, 1982-1986 CJ8, Transfer Case Mount [T5 5 Speeds] | 18608.02 |
| | 1982-1983 CJ5, 1982-1986 CJ7, 1982-1986 CJ8, Polyurethane Mount [T5 5 Speeds], Red | 18608.03 |
| | 1982-1983 CJ5, 1982-1986 CJ7, 1982-1986 CJ8, Polyurethane Mount [T5 5 Speeds], Black | 18608.04 |
| | 1982-1983 CJ5, 1982-1986 CJ7, 1982-1986 CJ8, Stabilizer Stud, Transmission Mount [T5 5 Speeds] | 18608.05 |
| | 1982-1983 CJ5, 1982-1986 CJ7, 1982-1986 CJ8, Stabilizer Bushing [T5 5 Speeds], [2 Required] | 18608.06 |
| | 1982-1983 CJ5, 1982-1986 CJ7, 1982-1986 CJ8, Polyurethane Stabilizer Bushing [T5 5 Speeds], Red, Pair | 18608.07 |
| | 1982-1983 CJ5, 1982-1986 CJ7, 1982-1986 CJ8, Polyurethane Stabilizer Bushing [T5 5 Speeds], Black, Pair | 18608.08 |
| | 1982-1983 CJ5, 1982-1986 CJ7, 1982-1986 CJ8, Shifter Boot [T5 5 Speed], With Bushing | 18885.30 |
| | 1982-1983 CJ5, 1982-1986 CJ7, 1982-1986 CJ8, Shifter Lever Kit [T5 5 Speed] | 18885.31 |
| | 1982-1983 CJ5, 1982-1986 CJ7, 1982-1986 CJ8, Shifter Handle Clip [T5 5 Speed] | 18885.32 |
| | 1982-1983 CJ5, 1982-1986 CJ7, 1982-1986 CJ8, Shifter Handle Insulator [T5 5 Speed] | 18885.33 |
| | 1982-1983 CJ5, 1982-1986 CJ7, 1982-1986 CJ8, Shifter Lever [T5 5 Speed] | 18885.34 |

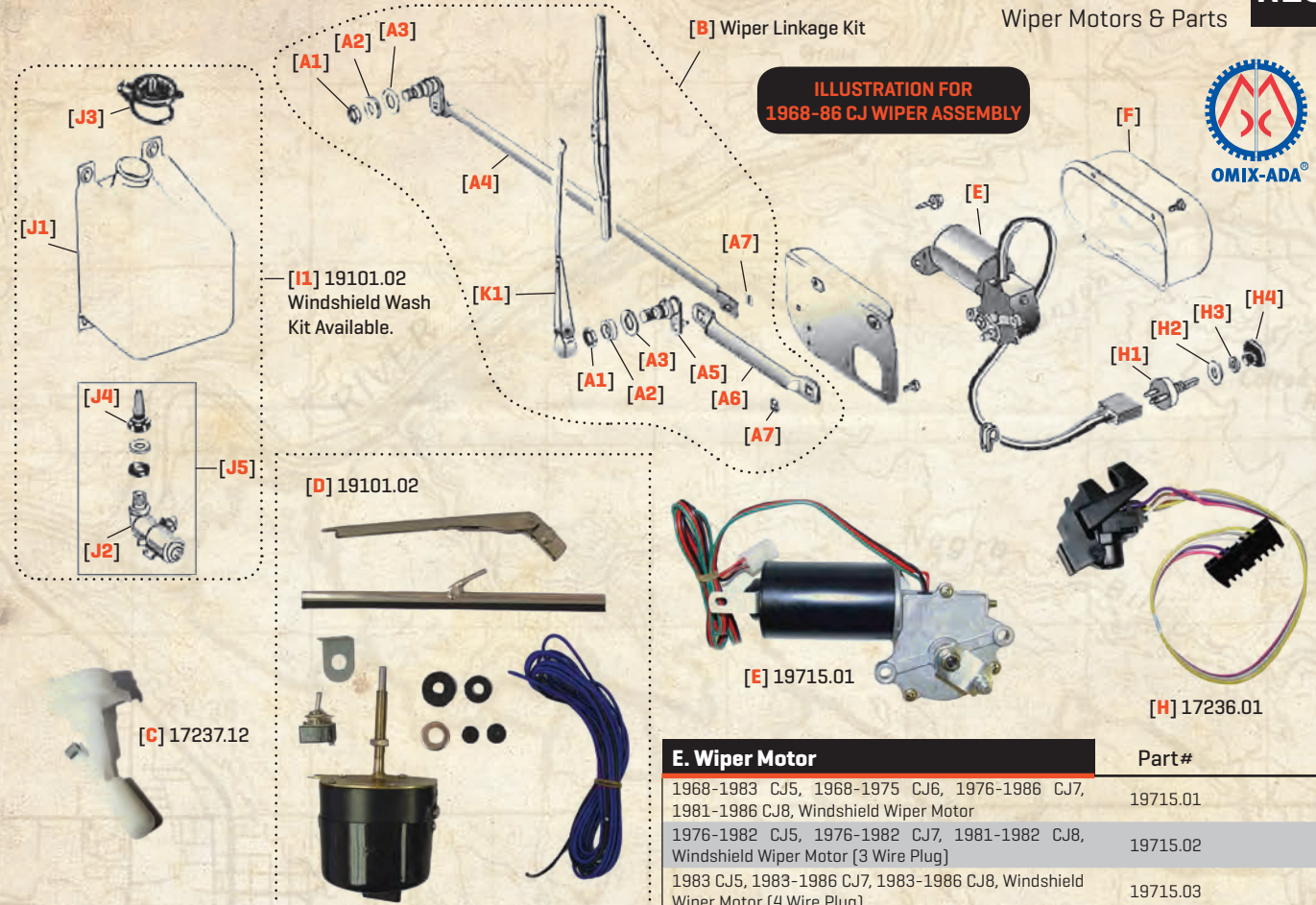

A. Wiper Linkage Part#

| | | |
|---|--|----------|
| 1 | 1968-1983 CJ5, 1968-1975 CJ6, 1976-1986 CJ7, 1981-1986 CJ8, Wiper Pivot Nut | 19105.01 |
| 2 | 1968-1983 CJ5, 1968-1975 CJ6, 1976-1986 CJ7, 1981-1986 CJ8, Wiper Pivot Spacer | 19105.02 |
| 3 | 1968-1983 CJ5, 1968-1975 CJ6, 1976-1986 CJ7, 1981-1986 CJ8, Wiper Pivot Gasket | 19105.03 |
| 4 | 1976-1983 CJ5, 1976-1986 CJ7, 1981-1986 CJ8, Wiper Pivot, Right [25" Long] | 19105.04 |
| 5 | 1976-1983 CJ5, 1976-1986 CJ7, 1981-1986 CJ8, Wiper Pivot, Left [Short] | 19105.06 |
| 6 | 1976-1983 CJ5, 1976-1986 CJ7, 1981-1986 CJ8, Wiper Motor Link [10.125"] | 19105.07 |
| 7 | 1968-1983 CJ5, 1968-1975 CJ6, 1976-1986 CJ7, 1981-1986 CJ8, Wiper Rod Clip | 19105.08 |

B. Wiper Linkage Kit Part#

1968-1983 CJ5, 1968-1975 CJ6, 1976-1986 CJ7, 1981-1986 CJ8, **Wiper Linkage Kit** (Includes: Both LH and RH Wiper Linkage, Pivot Spacers, Pivot Nuts, Pivot Gaskets, Pivot Clips, [2] Wiper Arms, and [2] Wiper Blades) 19105.05

C. Washer Fluid Level Sensors Part#

1991-2001 Grand Cherokee, 2002-2003 Liberty, Washer Fluid Level Sensor **NEW** 17237.12

D. Universal Wiper Motor Kits Part#

| | |
|---|----------|
| 1941-1945 MB, 1941-1945 Ford GPW, 1945-1949 CJ2A, 1948-1953 CJ3A, 1953-1958 CJ3B, 1955-1958 CJ5, 1955-1958 CJ6, 1946-1958 Truck, 1946-1958 Station Wagon, 1948-1951 Jeepster, Universal Wiper Motor Kit [6 Volt] | 19101.01 |
| 1945-1949 CJ2A, Wiper Motor Vacuum Tube | 12025.33 |
| 1950-1952 M38, 1952-1971 M38A1, Universal Wiper Motor Kit [24 Volt] | 19101.04 |
| 1959-1967 CJ3B, 1959-1971 CJ5, 1959-1971 CJ6, 1959-1964 Truck, 1959-1964 Station Wagon, Universal Wiper Motor Kit [12 Volt], Black | 19101.02 |
| 1959-1967 CJ3B, 1959-1971 CJ5, 1959-1971 CJ6, 1959-1964 Truck, 1959-1964 Station Wagon, Universal Wiper Motor Kit [12 Volt], Stainless Steel | 19101.03 |

E. Wiper Motor Part#

| | |
|--|----------|
| 1968-1983 CJ5, 1968-1975 CJ6, 1976-1986 CJ7, 1981-1986 CJ8, Windshield Wiper Motor | 19715.01 |
| 1976-1982 CJ5, 1976-1982 CJ7, 1981-1982 CJ8, Windshield Wiper Motor [3 Wire Plug] | 19715.02 |
| 1983 CJ5, 1983-1986 CJ7, 1983-1986 CJ8, Windshield Wiper Motor [4 Wire Plug] | 19715.03 |
| 1987-1995 Wrangler, Windshield Wiper Motor | 19715.04 |
| 1987-1995 Wrangler, Windshield Wiper Motor Gasket | 19716.01 |
| 1991-1995 Wrangler, Windshield Wiper Motor, Rear [With Hardtop] | 19717.01 |
| 1984-1990 Cherokee, Windshield Wiper Motor, Rear | 19717.02 |
| 1991-1996 Cherokee, Windshield Wiper Motor, Rear | 19717.03 |
| 1993-1996 Grand Cherokee, Windshield Wiper Motor | 19715.06 |
| 1993-1994 Grand Cherokee, Windshield Wiper Motor, Rear | 19717.04 |

F. Wiper Motor Cover Part#

| | |
|--|----------|
| 1968-1975 CJ5, 1968-1975 CJ6, Windshield Wiper Motor Cover, Stainless Steel | 11122.01 |
| 1976-1983 CJ5, 1976-1986 CJ7, 1981-1986 CJ8, Windshield Wiper Motor Cover, Black | 19135.01 |
| 1976-1983 CJ5, 1976-1986 CJ7, 1981-1986 CJ8, Windshield Wiper Motor Cover, Stainless Steel | 11122.02 |

G. Windshield Wipers & Components Part#

| | |
|--|----------|
| 1968-1983 CJ5, 1968-1975 CJ6, 1976-1986 CJ7, 1981-1986 CJ8, Wiper Pivot Cover [2 Required] | 13318.02 |
| 1987-1995 Wrangler, Windshield Washer Nozzle NEW | 19718.01 |

H. Wiper Switches Part#

| | |
|---|----------|
| 1968-1982 CJ5, 1968-1975 CJ6, 1976-1982 CJ7, 1981-1982 CJ8, Wiper Switch [3 Wire Plug] | 19106.01 |
| 1983 CJ5, 1983-1986 CJ7, 1983-1986 CJ8, Wiper Switch [Non-Intermittent] | 19106.02 |
| 1968-1983 CJ5, 1968-1975 CJ6, 1976-1986 CJ7, 1981-1986 CJ8, Wiper Switch Bezel | 17234.12 |
| 1968-1983 CJ5, 1968-1975 CJ6, 1976-1986 CJ7, 1981-1986 CJ8, Wiper Switch Nut | 17234.11 |
| 1968-1983 CJ5, 1968-1975 CJ6, 1976-1986 CJ7, 1981-1986 CJ8, Wiper Switch Knob | 13318.05 |
| 1987-1995 Wrangler, 1984-1994 Cherokee, Wiper Switch [Without Intermittent, Without Tilt] | 17236.01 |
| 1987-1995 Wrangler, 1984-1994 Cherokee, 1986-1991 Cherokee / Grand Wagoneer [SJ], Wiper Switch [Without Tilt] | 17236.04 |
| 1997-1999 Wrangler, Wiper Switch [Without Intermittent] | 17236.07 |
| 1997-1999 Wrangler, Wiper Switch [With Intermittent] | 17236.06 |
| 1997-1999 Wrangler, Wiper Switch, Rear [With Hardtop] | 17236.05 |
| 1984-1994 Cherokee, Wiper Switch [Without Intermittent, With Tilt] | 17236.03 |

All images are subject to be representative. More detailed information is available online.

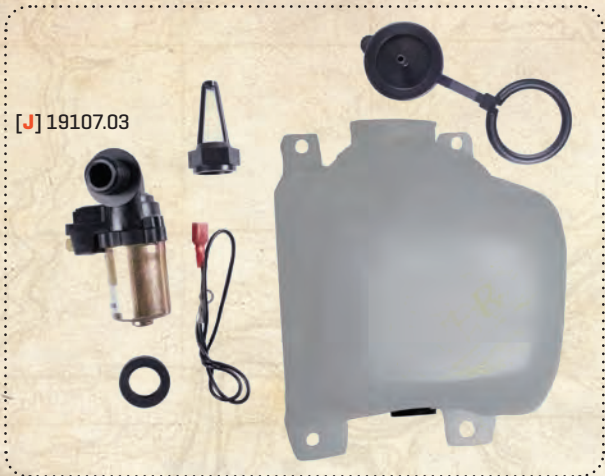

[J] 19107.03



[J] 19108.06



[H] 17236.07



[I] 19107.03



[E] 19716.01



[K] 19710.10

[K] 19710.11



[A] 19105.07

[L] 19712.01



[L] 19712.02



I. Windshield Washer Kit Part#

| | | |
|---|---|----------|
| 1 | 1972-1983 CJ5, 1968-1975 CJ6, 1976-1986 CJ7, 1981-1986 CJ8, Windshield Washer Kit (Includes Bottle, Cap, Pump & Filter) | 19107.03 |
|---|---|----------|

J. Washer Pump & Bottles Part#

| | | |
|---|---|----------|
| 1 | 1972-1983 CJ5, 1968-1975 CJ6, 1976-1986 CJ7, 1981-1986 CJ8, Windshield Washer Bottle | 19107.01 |
| | 1994-1995 Wrangler, Wiper Fluid Reservoir, With Dual Wiper Pumps NEW | 19107.05 |
| | 2002-2004 Liberty, Wiper Fluid Reservoir NEW | 19107.10 |
| | 2006-2007 Liberty, Wiper Fluid Reservoir, with Fluid Level Sensor Hole NEW | 19107.11 |
| | 2002-2004 Grand Cherokee, Wiper Fluid Reservoir NEW | 19107.12 |
| 2 | 1972-1983 CJ5, 1968-1975 CJ6, 1976-1986 CJ7, 1981-1986 CJ8, 1987-1990 Cherokee (Front), 1987-1996 Cherokee (Rear), 1972-1986 Cherokee / Grand Wagoneer (SJ), Windshield Washer Pump | 19108.01 |
| 2 | 1987-1989 Wrangler (Front), Windshield Washer Pump | 19108.04 |
| 2 | 1990-1995 Wrangler (Front), 1993-1998 Grand Cherokee (Front), Windshield Washer Pump | 19108.05 |
| 2 | 1997-2002 Wrangler (Front or Rear), 1997-2001 Cherokee (Front), Windshield Washer Pump | 19108.08 |
| 2 | 1991-1996 Cherokee (Front), Windshield Washer Pump | 19108.06 |
| 2 | 1997-2001 Cherokee (Rear), Windshield Washer Pump | 19108.08 |
| 3 | 1972-1983 CJ5, 1968-1975 CJ6, 1976-1986 CJ7, 1981-1986 CJ8, Windshield Washer Bottle Cap | 19107.02 |
| 4 | 1972-1983 CJ5, 1968-1975 CJ6, 1976-1986 CJ7, 1981-1986 CJ8, 1972-1986 Cherokee / Grand Wagoneer (SJ), Windshield Washer Pump Filter | 19108.02 |
| 5 | 1972-1983 CJ5, 1968-1975 CJ6, 1976-1986 CJ7, 1981-1986 CJ8, 1972-1986 Cherokee / Grand Wagoneer (SJ), Windshield Washer Pump Kit (Includes Pump & Filter) | 19108.03 |

K. Wiper Arms Part#

| | | |
|---|---|----------|
| 1 | 1968-1983 CJ5, 1968-1975 CJ6, 1976-1986 CJ7, 1981-1986 CJ8, Wiper Arm, Black | 19710.02 |
| 1 | 1968-1983 CJ5, 1968-1975 CJ6, 1976-1986 CJ7, 1981-1986 CJ8, Wiper Arm, Stainless Steel | 19710.01 |
| | 1987-1995 Wrangler, Windshield Wiper Arm (LH or RH) | 19710.03 |
| | 1987-1995 Wrangler, Windshield Wiper Arm, Rear | 19710.03 |
| | 1997-2006 Wrangler, Windshield Wiper Arm (LH or RH) | 19710.05 |
| | 1997-2002 Wrangler, Windshield Wiper Arm, Rear | 19710.06 |
| | 1984-1996 Cherokee, Windshield Wiper Arm (LH or RH) | 19710.07 |
| | 1984-1996 Cherokee, Windshield Wiper Arm, Rear | 19710.08 |
| | 1997-2001 Cherokee, Windshield Wiper Arm (LH or RH) | 19710.13 |
| | 1997-2001 Cherokee, Windshield Wiper Arm, Rear | 19710.14 |
| | 1993-1998 Grand Cherokee, Windshield Wiper Arm (LH or RH) | 19710.09 |
| | 1993 Grand Cherokee, Windshield Wiper Arm, Rear | 19710.10 |
| | 1994-1995 Grand Cherokee (Without Flip Window), Windshield Wiper Arm, Rear | 19710.11 |
| | 1995-1996 Grand Cherokee (With Flip Window), 1997-1998 Grand Cherokee (All), Windshield Wiper Arm, Rear | 19710.12 |

L. Wiper Blades Part#

| | | |
|--|---|----------|
| | 1941-1945 MB, 1941-1945 Ford GPW, 1945-1949 CJ2A, 1948-1953 CJ3A, 1953-1958 CJ3B, 1955-1958 CJ5, 1955-1958 CJ6, Windshield Wiper Arm & Blade Kit, Stainless Steel | 19102.01 |
| | 1968-1983 CJ5, 1968-1975 CJ6, 1976-1986 CJ7, 1981-1986 CJ8, Wiper Blade [11"] | 19712.07 |
| | 1987-2006 Wrangler (Front), Wiper Blade [13"] | 19712.01 |
| | 1987-1995 Wrangler (Rear), Wiper Blade [16"] | 19712.04 |
| | 1997-2006 Wrangler (Rear), 1984-2001 Cherokee (Front), Wiper Blade [18"] | 19712.02 |
| | 2007-2012 Wrangler (Front), Wiper Blade [15"] NEW | 19712.08 |
| | 1984-2001 Cherokee (Rear), 1993-2004 Grand Cherokee (Rear), Wiper Blade [13"] | 19712.05 |
| | 1993-1998 Grand Cherokee (Front), 2002-2007 Liberty (Front), Wiper Blade [19"] | 19712.03 |
| | 1999-2011 Grand Cherokee (Front), Wiper Blade [21"] NEW | 19712.09 |

| Description | Part# |
|---|----------|
| Hood 01-07 Town & Country, Caravan, Voyager | 12049.01 |
| Fender Rh 01-07 Town & Country, Caravan, Voyager | 12049.10 |
| Fender Lh 01-07 Town & Country, Caravan, Voyager | 12049.11 |
| Fender Rh 96-00 Town & Country, Caravan, Voyager | 12049.12 |
| Fender Lh 96-00 Town & Country, Caravan, Voyager | 12049.13 |
| Water Pump 82-88 Town & Country, Caravan, Lebaron, Laser | 17104.70 |
| Water Pump 2.6L 81-87 Town & Country, Caravan | 17104.71 |
| Belt 3.0L With Ac 91-92 Chrysler As Body | 17110.85 |
| Serpentine Belt 2.5L With Power Steering 93-95 Chrysler As Body | 17111.80 |
| Serpentine Belt 2.4L Ps Chrysler Ns 2.4L | 17111.81 |
| Serpentine Belt 2.4L With Ac Chrysler Ns 2.4L | 17111.82 |
| Serpentine Belt 2.4L Without Ac Chrysler Ns 2.4L | 17111.83 |
| Serpentine Cooling Belt 3.0L W/Ac 93-95 Chrysler As Body | 17111.84 |
| Serpentine Belt 3.3L, 3.8L 1991Chrysler As Body | 17111.85 |
| Serpentine Belt 3.0L Chrysler Ns | 17111.86 |
| Serpentine Belt 3.3L, 3.8L Chrysler Ns | 17111.87 |
| Serpentine Belt 3.3L 3.8L With Ac 91-97 S Body NEW | 17111.88 |
| Idler Pulley Chrysler Ls 2.7L, Lhs; Rs/Rg 3.3L & 3.8L; Viper 03-04 8.3L | 17112.08 |
| Tensioner Assembly 91-97 Chrysler As/Ns Body | 17112.53 |
| Tensioner Chrysler Ns 3.3L, 3.8L | 17112.54 |
| Radiator Hose Upper Chrysler S-Body 2.2L, 2.5L | 17113.80 |
| Radiator Hose Upper 2.5L 90-92 Chrysler S/As Body | 17113.81 |
| Radiator Hose Upper 2.5L 93-95 Chrysler As Body | 17113.82 |
| Radiator Hose Upper 3.3L 90-92 Chrysler S/As Body | 17113.83 |
| Radiator Hose Upper 3.0L 93-95 Chrysler As Body | 17113.84 |
| Radiator Hose Upper 3.3L, 3.8L With Hd Cooling 93-95 As Body | 17113.85 |
| Radiator Hose Upper 3.0L Chrysler S-Body | 17113.86 |
| Radiator Hose Lower 3.0 With A670 93-95 Chrysler As Body | 17114.80 |
| Radiator Hose Upper 3.3L, 3.8L 93-95 Chrysler As Body | 17114.81 |
| Radiator Hose Lower 3.0L Chrysler Ns | 17114.82 |
| Radiator Hose Lower 2.5L 91-92 Chrysler As Body | 17114.83 |
| Radiator Hose Lower 2.5L 93-95 Chrysler As Body | 17114.84 |
| Radiator Hose Lower 3.0 89 S-Body | 17114.85 |
| Radiator Hose Lower 3.0L With A604 93-95 Chrysler As Body | 17114.86 |
| Radiator Hose Lower 3.0L With A670 90-91 Chrysler S/As Body | 17114.87 |
| Radiator Hose Lower 3.0L With Hd Cooling 93-95 Chrysler As Body | 17114.88 |
| Radiator Hose Lower 3.3L 91-92 Chrysler As Body | 17114.89 |

| Description | Part# |
|---|----------|
| Radiator Hose Lower 3.3L, 3.8L 93-95 Chrysler As Body | 17114.90 |
| Radiator Hose Lower 2.5L Chrysler S-Body | 17114.91 |
| Inlet Hose Chrysler Ns 2.4L | 17115.50 |
| Inlet Hose Chrysler Ns 3.0L | 17115.51 |
| Inlet Hose Chrysler Ns 3.3L & 3.8L | 17115.52 |
| Outlet Hose Chrysler Ns 2.4L | 17115.60 |
| Outlet Hose Chrysler Ns 3.3L & 3.8L | 17115.61 |
| Timing Belt 2.4L 97-07 Chrysler Gs, Ns, Rs Body | 17453.18 |
| Timing Belt 2.5L Chrysler S/As-Body | 17453.80 |
| Timing Belt 2.5L Chrysler S-Body | 17453.81 |
| Alternator 120 Amp 91-95 S Body | 17225.80 |
| Starter 3.0L 91-95 Chrysler As Body | 17227.80 |
| Ignition Wire Set As Body 3.3L | 17245.80 |
| Ignition Wire Set 2.5L As Body | 17245.81 |
| Ignition Wire Set As, Ns Body 3.3L & 3.8L | 17245.82 |
| Ignition Wire Set 84-91 S Body 2.2L & 2.5L | 17245.83 |
| Ignition Wire Set 84-87 2.6L S-Body | 17245.84 |
| Ignition Wire Set 96-00 2.4L Ns Body | 17245.85 |
| Ignition Wire Set 3.0L S & As Body | 17245.86 |
| Ignition Wire Set Rs 3.3L, 3.8L | 17245.87 |
| Ignition Wire Set 3.0 Ns | 17245.88 |
| Ignition Wire Set 2.4L Rs Body | 17245.89 |
| Front Hub, 1995 Chrysler Lebaron Conv. | 16705.50 |
| Rear Hub, 2000-02 Plymouth Prowler | 16705.51 |
| Front Hub, 2000-04 Concorde, Intrepid, Lhs, 300M | 16705.51 |
| Front Hub, 1995-97 Stratus, Cirrus, Plymouth Breeze | 16705.52 |
| Front Hub, 1996-99 Sterling Convertible | 16705.52 |
| Front Hub, 1992-95 All Mini-Van W/ 15" Wheel | 16705.53 |
| Front Hub, 1996-00 All Mini-Van W/ 14" Wheel | 16705.54 |
| Front Hub, 1997-04 All Mini Van W/ 15" Or 16" Wheel | 16705.53 |

- AS 1991-1995 Town & Country, Caravan, Voyager
- LH 1993-2004 New Yorker, Concorde, LHS, 300M, Intrepid, Vision
- NS 1996-2000 Town & Country, Caravan, Voyager
- RG 2001-2006 Town & Country, Caravan, Voyager (Export)
- RS 2001-2007 Town & Country, Caravan, Voyager
- S 1984-1990 Town & Country, Caravan, Voyager

SURPLUS

CHEROKEE - CJ - WRANGLER

The legend of the "Jeep" in a crate has been around for years. Nobody has been able to prove this legend until now. Hundreds of surplus crates containing CJ - Cherokee - and even Wrangler parts from all over the globe, have been sourced and brought to our warehouse. Each crate contains just one piece to a puzzle of a thousand parts that make up any number of Jeep® systems or even complete vehicles.

JEEP CHEROKEE (RHD)

We have thousands of OE high quality factory fresh replacement parts for your 1984-96 Jeep® Cherokee. These crates were packed at the Toledo factory in 1996 for the export of 288 Cherokees to be assembled in an overseas market. All items were packed in bulk and have been sealed in their crates for the past ten years. All parts look like the day they came off the assembly line here in the U.S. and Canada. All of the surplus parts were either manufactured here in the States or in Canada and are of true OE quality. Looking for that replacement axle assembly? We have it. Looking for that small bolt or fastener that's just not stocked anymore? We have it. If it was made for the first generation Cherokees, then odds are we have what you are looking for.

CJ & WRANGLER SURPLUS

As with the Cherokee stock we have acquired a large number of crates containing many CJ and Wrangler components. The crates are being opened and new stock is being readied for sale daily. Items range from transmissions to mirrors and many more items you will find listed in the following pages of this catalog. For complete listing, please visit our website.



Please keep in mind that even though there is a large supply of these surplus parts, quantities are limited. When the part you need sells out, it's gone for good. For this reason, we are selling on a first come, first serve basis.



OMIX-ADA, Inc.

R112 REPLACEMENT PARTS

Surplus

S-52108046



CHRYSLER-JEEP® TRANSMISSIONS

The following transmissions were originally supplied for 1996 export Cherokee vehicles, but can be used for any Jeep® application where they were installed by the factory.



AX5 MANUAL TRANSMISSION

Used with Cherokee 2.5L 4 cylinder engine.

S-4810179

- Jeep® models that used the AX5 manual transmission
- 1994-96 Cherokee with 2.5L 4 cylinder engine
- 1984-93 Cherokee with 2.5L 4 cylinder engine [may require modifications]
- 1987-98 Wrangler with 2.5L 4 cylinder engine [may require modifications]



AW4 AUTOMATIC TRANSMISSION

Used with 4.0L High Output engines, and has a 23 spline output shaft. Gear ratios were 2.80, 1.53, 1.00, and .75

S-52119156

- Jeep® models that used the AW4 automatic transmission
- 1991-96 Cherokee [XJ], Comanche pick-ups [MJ] 6 cylinder
- 1993 Grand Cherokee [ZJ] 6 cylinder

32RH AUTOMATIC TRANSMISSION

with 23-spline output used with 4.0L 6 cylinder engines.

This automatic transmission was originally supplied for 1994-96 export Wrangler with 4.0L 6 cylinder engines, but can be used for any Jeep® application where part number 52118024 was installed by the factory.

- Jeep® models that used the 32RH automatic transmission
- Jeep® part number S-52118024
- 1992-95 Wranglers with 4.0L 6 cylinder engine
- 1996 Export Wrangler with 4.0L 6 cylinder engine

S-52099310



CHRYSLER-JEEP® TRANSFER CASES

The following transfer cases were originally supplied for 1996 export Cherokee vehicles, but can be used for any Jeep® application where they were installed by the factory.



NP231 (S-52099310) CHAIN DRIVE TRANSFER CASE

S-52098358

For 2.5L 4 cylinder with manual transmissions. Has a 21-spline input, and a 1.2" short shaft.

- Jeep® models that used the NP231 21-spline transfer case.
- Any 4 cylinder Jeep with an AX4, or AX5 manual transmission
- Any 4 cylinder Jeep with an AW4 up to 1990 with 21-spline output.

NP231 (S-52098358) CHAIN DRIVE TRANSFER CASE

For 4.0L 6 cylinder with manual transmissions, 23-spline input, [1.2" short shaft].

- Jeep® models that used the NP231 23-spline transfer case with manual transmission and some automatics
- Any 6 cylinder Jeep® equipped with a 1989-94 AX15
- Any 6 cylinder Jeep® equipped with an AW4 after 1990, 23-spline output



NP231 (S-52098360) CHAIN DRIVE TRANSFER CASE

For 4.0L 6 cylinder with automatic transmissions, 23-spline input, [2.1" long shaft].

S-52098360

- Jeep® models that used the NP231 23-spline transfer case with automatic transmission and some manual transmission
- Any 6 cylinder Jeep® equipped with a 1996-01 AX15
- Any 6 cylinder Jeep® equipped with a 31RH or 32RH automatic

RELATED SURPLUS TRANSMISSION & TRANSFER CASE PARTS

| Description | Part# |
|---|------------|
| Bell Housing 1997-00 Cherokee 2.5L Manual | S-52104000 |
| Bell Housing 1987-1993 Cherokee [4.0L] Manual | S-53007105 |
| Transmission Cushion 1984-86 Cherokee V6 | S-52001180 |

| Description | Part# |
|--|--------------|
| 1997-98 Cherokee 2.5L 231 Transfer Case Lever Assembly | S-52104101AB |
| 1997-98 Cherokee 4.0L 242 Transfer Case Lever Assembly | S-52104103 |
| Cherokee 4.0L Automatic Shift Lever 1996 Aw4 | S-52104107 |

ALL SURPLUS EQUIPMENT IS OF A LIMITED SUPPLY AND WILL BE SOLD ON A FIRST COME FIRST SERVE BASIS ONLY.



S-52069795

The following axle assemblies were originally supplied for 1996 export right hand drive Cherokee vehicles, but can be used for any Jeep® application where they were installed by the factory.

S-52069795 DANA 35 REAR AXLE ASSEMBLY with 3.54 gears

S-52069381



Jeep® models that can use the Dana 35 axle.

- 1984-01 Jeep Cherokee
- Comanche pick-up
- Any Wrangler or Grand Cherokee with rear leaf spring design [some modifications required].

S-52069201



Axles come with leaf spring mounting perches

S-52069381 Chrysler 8.25 rear axle assembly w/ 4.10 gears w/ Track-Lok

S-52069200



Jeep® models that can use the 8.25 rear axle.

- 1984-01 Jeep Cherokee
 - Comanche pick-up
 - Any Wrangler or Grand Cherokee with rear leaf spring design.
- Axles come with leaf spring mounting perches

S-52098731

S-52098744

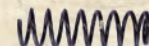

S-53005541

S-52087831

S-52001124



S-52000229

The front axle assembly was exported as a RHD unit but can be used domestically w/ modifications.

RHD = right hand drive vehicle.

S-52069201 High Pinion Dana 30 front assembly with 4.10 gears.

RIGHT HAND DRIVE (RHD)

S-52069200 High Pinion Dana 30 front assembly with 3.54 gears.

RIGHT HAND DRIVE (RHD)

Jeep® models that had a coil spring Dana 30 front axle.

1994-01 [RHD] Jeep Cherokee [XJ]

Note: these front axle assemblies can be modified to work w/ other front applications (LHD) but will require some cutting and rewelding.



OMIX-ADA, Inc.

Surplus Parts

RELATED SURPLUS AXLE & DRIVELINE PARTS CHEROKEE

| Description | Part# |
|---|------------|
| 1994-99 Driveshaft Rear 4.0L Auto | S-52098731 |
| 1996-99 Driveshaft Rear 2.5L Man | S-52098744 |
| 1987-00 Driveshaft Front 2.5L Man | S-53005541 |
| 1984-01 Front Spring Coil | S-52001124 |
| 1996 Front Shock | S-52087831 |
| 1994-01 Front Sway Bar | S-52087859 |
| 1992-01 Rear Sway Bar | S-52001135 |
| 1984-01 Front Coil Spring Insulator | S-52000229 |
| Dana 35 Rear Axle Assembly w 3.55 Ratio | S-52069795 |

JEEP® CHEROKEE BODY PARTS (SURPLUS LIMITED SUPPLY)



| A. Bumper | Part# |
|--|------------|
| 1984-96 Front Bumper (Black) 2 Door & 4 Door | S-55234551 |
| 1984-96 Front Bumper (No Paint) 2 Door & 4 Door | S-55234549 |
| 1984-96 Rear Bumper (No Paint) 2 Door & 4 Door | S-55234617 |
| B. Grille | Part# |
| 1984-96 Front Bumper (Black) 2 Door & 4 Door | S-55234551 |
| 1984-96 Front Bumper (No Paint) 2 Door & 4 Door | S-55234549 |
| 1984-96 Rear Bumper (No Paint) 2 Door & 4 Door | S-55234617 |
| C. Cowl | Part# |
| 1984-96 Cowl Filter Screen (Rhd Only) | S-55027697 |
| 1984-96 Cowl Grille (Rhd Only) | S-55027696 |
| D. Hood | Part# |
| 1984-01 Hood, 2 Door & 4 Door Model Cherokee | S-55235439 |
| 1984-01 Hood Hinge, Right Side | S-55075180 |
| 1984-01 Hood Hinge, Left Side | S-55075181 |
| 1984-96 Hood (Bonnet) Release Cable Assembly | S-55075570 |
| E. Body Side Panels | Part# |
| 1984-96 Left Side Body Panel (4 Door Models) | S-55235539 |
| 1984-96 Right Side Body Panel (4 Door Models) | S-55235538 |
| F. Doors | Part# |
| 1984-96 Front Left (Driver's) Door (4 Dr Models) | S-55235251 |
| 1984-96 Front Right (Passenger's) Door (4 Dr Models) | S-55235250 |
| 1984-96 Rear Left (Driver's) Door (4 Drs Models) | S-55176003 |
| 1984-96 Rear Right (Passenger's) Door (4 Dr Models) | S-55176002 |
| G. Roof & Floors | Part# |
| 1984-96 Roof Panel W/Roof Rack Mounting Holes 2&4Dr | S-55254639 |
| 1995-96 Front Floor Pan 2 Door & 4 Door Cherokee | S-55174807 |
| 1993-96 Rear Floor Pan 2 Door & 4 Door Cherokee | S-55235380 |

| H. Frame | Part# |
|--|------------|
| 1984-96 Crossmember assembly 2 door & 4 door | S-52002328 |
| 1984-96 Front skid plate | S-52018009 |
| I. Rear Liftgate | Part# |
| 1984-96 Rear liftgate (composite) 2 door & 4 door | S-55235531 |
| 1984-96 Rear liftgate hinge left side | S-55075295 |
| 1984-96 Rear liftgate hinge right side | S-55075294 |
| J. Head Lamp | Part# |
| 1984-96 RH head lamp [Hella H4 55W-60W] w/o level device | S-55054828 |
| 1984-96 LH head lamp [Hella H4 55W-60W] w/o level device | S-55054829 |
| K. Front Signal Lamp | Part# |
| 1984-96 Front signal lamp, RH (amber, export only) | S-55155072 |
| 1984-96 Front signal lamp, LH (amber, export only) | S-55155073 |
| 1984-96 Front fender turn signal (export only) | S-55055014 |
| 1984-96 Front parking lamp, LH (amber, export only) | S-56000853 |
| 1984-96 Front parking lamp, RH (amber, export only) | S-56000852 |
| L. Rear Signal Lamp | Part# |
| 1984-96 Rear lamp assy, right side (export) | S-55155464 |
| 1984-96 Rear lamp assy, left side (export) | S-55155465 |
| 1996 Rear stop light, center mount | S-5ED63PS1 |
| M. Exterior Trim | Part# |
| 1984-96 Window seal, rear quarter (4 door) | S-55007129 |
| 1994-01 Front windshield molding | S-55235391 |
| 1984-96 Roof rack assembly 2 door and 4 door | S-55235277 |
| N. Fenders | Part# |
| 1984-01 RH | S-55235216 |
| 1984-01 LH | S-55235217 |

All images are subject to be representative. More detailed information is available online.

Surplus

[M]



[C] S-55000766



[L] CR-017C & CR-017F



[A] S-55029245

[B]



[D] S-5AB98JS1



[G] S-55154734



OMIX-ADA, Inc.



[F] S-5EY13SA8



[H] S-5FG76SS1



[K] S-5FM76SA8



[J] S-55114998



[E] S-5FN38SSA

[I] S-5BG07KS1

A. Bumper End Caps

| Part# | Part# |
|--|------------|
| 1984-96 Front left bumper end cap (black grain texture) | S-55234545 |
| 1984-96 Front right bumper end cap (black grain texture) | S-55234544 |
| 1984-96 Rear left bumper end cap (black grain texture) | S-55029245 |
| 1984-96 Rear right bumper end cap (black grain texture) | S-55029244 |
| 1984-96 Rear left bumper end cap (gray, smooth) | S-55234691 |
| 1984-96 Rear right bumper end cap (gray smooth) | S-55234690 |

B. Fender Flares

| Part# | Part# |
|--|------------|
| 1984-96 Front fender flare right side smooth (paintable) | S-55175482 |
| 1984-96 Front fender flare left side smooth (paintable) | S-55175483 |
| 1984-96 Rear fender flare right side smooth (paintable) | S-55005879 |
| 1984-96 Rear fender flare left side smooth (paintable) | S-55005878 |

C. Door Latch

| Part# | Part# |
|---|------------|
| 1984-96 Door latch assembly, right side (front) | S-55000766 |
| 1984-96 Door latch assembly, left side (front) | S-55000767 |
| 1984-96 Door latch assembly, right side (rear) | S-55075878 |
| 1984-96 Door latch assembly, left side (rear) | S-55075879 |

D. Arm Rests

| Part# | Part# |
|--|------------|
| 1984-96 Front right arm rest w/ pull handle (light gray) | S-5AB98JS1 |
| 1984-96 Front left arm rest w/ pull handle (light gray) | S-5AB99JS1 |
| 1984-96 Rear arm rest for left & right 4dr (light gray) | S-5AC34JS1 |
| 1984-96 Front right arm rest w/ pull handle (dark gray) | S-5AB98JA8 |
| 1984-96 Rear arm rest for left & right 4dr (dark gray) | S-5AC34JA8 |

E. Door Trim

| Part# | Part# |
|--|------------|
| 1984-96 Front door panel right side (gray) | S-5FN38SSA |
| 1984-96 Front door panel left side (gray) | S-5FN39SSA |
| 1984-96 Wood grain door trim, right rear (gray) | S-5DD70MS1 |
| 1984-96 Wood grain door trim, left rear (gray) | S-5DD71MS1 |
| 1984-96 Wood grain door trim, right front (gray) | S-5DD66MS1 |
| 1984-96 Wood grain door trim, left front (gray) | S-5DD67MS1 |

F. Dash

| Part# | Part# |
|--|------------|
| 1984-96 Dash pad assembly (RHD only) | S-5EY13SA8 |
| 1984-96 Wood grain instrument bezel (RHD) | S-55115072 |
| 1984-96 Black instrument bezel (RHD) | S-55115070 |
| 1995-96 Leather wrapped steering wheel w/o air bag | S-5FJ14SX9 |

G. Mirrors

| Part# | Part# |
|--------------------------------------|------------|
| 1984-96 Right side mirror (RHD only) | S-55154683 |
| 1984-96 Left side mirror (RHD only) | S-55154734 |

H. Visor

| Part# | Part# |
|---|------------|
| 1984-96 RHD Front visor w/ Light (left side) | S-5FG76SS1 |
| 1984-96 RHD Front visor w/ Light (right side) | S-5FK76SS1 |

I. B-Pillar Trim

| Part# | Part# |
|---|------------|
| 1984-96 B-pillar upper cover, driver side (gray) | S-5BG07KS1 |
| 1984-96 B-pillar upper cover, passenger side (gray) | S-5BG06KS1 |
| 1984-96 B-pillar lower cover, driver side (gray) | S-5EU70RS1 |
| 1984-96 B-pillar lower cover, passenger side (gray) | S-5EU71RS1 |

J. Console

| Part# | Part# |
|---|------------|
| 1984-96 Center console insert (Black) 2dr and 4dr | S-55114998 |
| 1984-96 Center console (gray) 2dr and 4dr | S-5FG26SA8 |

K. Cargo Area

| Part# | Part# |
|--|------------|
| 1984-96 Rear cargo cover assemble (gray) | S-5FC34RS1 |
| 1984-96 Spare tire cover (gray) | S-5FM76SA8 |
| 1984-96 Rear scuff cover (gray) | S-5AC55JS1 |

L. Hitch Brake Light

| Part# | Part# |
|---|---------|
| Hitch Brake Light, LED, Oval, Chevrolet Logo, Universal, For 2-Inch Hitch Receivers | CR-017C |
| Hitch Brake Light, LED, Oval, Ford Logo, Universal, For 2-Inch Hitch Receivers | CR-017F |

M. Truck Bed Mats

| Part# | Part# |
|-------------------------------------|---------|
| Chevy Full Size Bed Mat | KO-9523 |
| Ford Full Size Bed Mat | KO-9524 |
| Dodge Full Size Bed Mat | KO-9525 |
| Ford Mini Size Bed Mat | KO-9527 |
| 2007 Silverado/Sier Bed Mat | KO-9528 |
| Chevy Full Size Tail Gate Protector | KO-9580 |
| Ford Full Size Tail Gate Protector | KO-9581 |
| Dodge Full Size Tail Gate Protector | KO-9582 |
| 98-88 Gm F/S Trk 8' Bed Mat | KO-9052 |
| Chevy Mini Size Bed Mat | KO-9526 |
| Ford Mini Size Tail Gate Protector | KO-9584 |
| Chevy Mini Size Tail Gate Protector | KO-9583 |

Surplus Parts

All images are subject to be representative. More detailed information is available online.

JEEP® CHEROKEE HARD PARTS (SURPLUS LIMITED SUPPLY)



[A] S-52030035AB



[C] S-56003151



[F] S-55037359



[C] S-56027867



[G] S-56022095



[D] S-52008647



[F] S-55036779



[G] S-4798941

[H] S-52078556



[B] S-52079347

[H] S-52006505

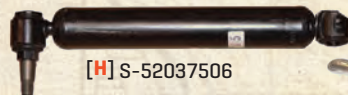

[H] S-52037506



[E] S-52022039



[H] S-52080229



[H] S-56022278AA



| A. Cooling System | Part# |
|---|--------------|
| 1996 Fan Shroud 4.0L 6 cyl (RHD) | S-52028324 |
| 1996 Fan (7 blades) | S-52028603 |
| 1996 Fan (7 blades) | S-52030035AB |
| 1996 Coolant bottle assembly RHD [export] | S-52079340 |

| B. Electrical Parts- Drive Train | Part# |
|---------------------------------------|------------|
| 1993-96 Sensor (HI-TEMP) | S-56027012 |
| 1996 ignition wires 2.5L 4 cyl (4pcs) | S-56027219 |
| 1996 Speed control assembly | S-52079347 |
| 1996-97 Speed control switch assembly | S-56007712 |

| C. Electrical Parts- General | Part# |
|--|------------|
| 1993-00 Switch & bezel (window) right rear | S-56007218 |
| 1993-00 Switch & bezel (window) left rear | S-56007221 |
| 1984-96 Switch assy (window, door) left front (RHD) | S-56007223 |
| 1984-96 Switch assy (window, door) right front (RHD) | S-56010051 |
| 1984-96 Instrument cluster (RHD, Kilometers) | S-56009018 |
| 1992-96 Power window regulator, front left side | S-55235647 |
| 1992-96 Power window regulator, front right side | S-55235646 |
| 1994-96 Power window regulator, rear left side | S-55154899 |
| 1994-96 Power window regulator, rear right side | S-55154898 |
| 1984-96 Power antenna assembly | S-56003151 |
| 1984-96 Washer reservoir with two pumps | S-55155318 |
| 1984-96 Wiper motor assembly RHD with linkage | S-55155300 |
| 1984-00 Power door solenoid right side | S-J3721500 |
| 1984-00 Power door solenoid left side | S-J3721501 |
| 1997-02 2.5L Crankshaft Position Sensor | S-56027867 |
| 1997-05 4.0L Crankshaft Position Sensor | S-56027867 |

| D. Brake Parts | Part# |
|---|------------|
| 1996 Power brake booster with master cylinder | S-52008647 |
| 1996 Hydraulic ABS control unit | S-52008727 |
| 1996-99 Proportioning valve assembly | S-52129025 |
| 1996 E-brake lever assembly (2.5L - manual) | S-52127958 |

| E. Exhaust Parts | Part# |
|--|------------|
| 1996 Muffler assembly with tail pipe, 4.0L 6 cyl | S-52022039 |
| 1984-96 OE exhaust pipe clamp | S-52018424 |
| 1984-96 OE exhaust insulator | S-52001759 |
| 1996-99 4.0L Front exhaust pipe | S-52020069 |

| F. Heating & A/C Parts | Part# |
|--|------------|
| 1996 A/C Condensor | S-55036779 |
| 1992-96 Vacuum reservoir | S-52004366 |
| 1984-96 Dash mount A/C vent control assembly (RHD) | S-56022016 |
| 1994-96 A/C receiver - drier | S-55036112 |
| 1994-96 2.5L & 4.0L A/C compressor R-134 | S-55037359 |
| 1994-01 CHEROKEE 2.5L RHD A/C compressor R-134 | S-55037360 |

| G. Fuel & Intake System Parts | Part# |
|---|------------|
| 1996 Fuel tank without sending unit | S-56022095 |
| 1994-96 Fuel pump with regulator & sending unit (in tank) | S-4798941 |
| 1984-96 Fuel tank skid plate | S-52001512 |
| 1996 Filter box air hose assembly | S-53006274 |
| 1997-00 Vapor return canister | S-53031904 |

| H. Steering Parts | Part# |
|--|--------------|
| 1995-96 Steering assembly [intermediate] | S-52078556 |
| 1991-01 CHEROKEE RHD Pitman arm (power steering) | S-52006505 |
| 1991-01 CHEROKEE RHD Steering stabilizer shock | S-52037506 |
| 1996 Steering column assembly - tilt | S-52080229 |
| 1997-01 Power steering box - RHD only | S-56022278AA |
| 1995-96 AirBag (steering wheel, black) *** | S-5FL22SX8 |
| 1984-96 Steering linkage assembly - RHD | S-52006507 |
| 1996 Steering wheel without air bag | S-5FJ14SX9 |

*** Export only, cannot be sold in domestic US.

Is the front of your CJ sagging with all you extra gear, or just slumping due to age. Try replacing them with these heavy duty 7 layer military wrapped front springs for 1976-86 CJ's.

P/N : **S-J5364230**

Time, heat, cold, and water can damage your hard top side vent windows. We have both left and right side vent windows in stock. Hurry because these will not last long.

S-55176281 (LH)
S-55176280 (RH)

| Misc. Parts | Part# |
|---|-------------|
| "LUG WRENCH WRANGLER, 3/4" | S-52003583 |
| 1987-95 FRONT PROP SHAFT (6 CYL) W/ AUTOMATIC | S-52088028 |
| 1987-06 HUB CAPS W/ JEEP LOGO FOR STEEL WHEEL | S-52089008 |
| 1994-96 NP231 TRANSFER CASE 23 SPLINE INPUT (4.0L) MANUAL | S-52098358 |
| 1994-96 NP231 TRANSFER CASE 23 SPLINE INPUT (4.0L) AUTO | S-52098360 |
| 1994-96 AUTOMATIC TRANS. ASSY. (4.0L) | S-52119156 |
| IDLER PULLEY (fits many applications) | S-53002903 |
| 1991-96 4.0L WRANGLER, OXYGEN SENSOR | S-56028301 |
| 1991-99 4.0L WRANGLER, FAN CLUTCH | S-52027626 |
| 1991-95 2.5L WRANGLER, FAN CLUTCH | S-52027626 |
| HEATER ASSEMBLY WITH BLOWER MOTOR WRANGLER | S-55036899 |
| 1987-95 WRANGLER FLOOR PAN TRANSMISSION TUNNEL COVER (automatic) | S-53004650 |
| HD FRONT LEAF SPRING W/ MILITARY WRAP 7 LAYER FOR CJ | S-J5364230 |
| 1972-05 DETROIT TRUTRAC LIMITED SLIP FOR DANA 30 (2.73-3.54 ratios) | S-TT-912374 |
| 1991-95 WRANGLER FULL DOOR INNER PANEL (GRAY) LEFT SIDE | S-5AE13KXA |
| 1987-95 WRANGLER WITHOUT A/C, VENT CONTROL ASSEMBLY | S-55036371 |
| 1987-95 WRANGLER KDX FRAME CROSS MEMBER | S-52002727 |
| 1987-95 WRANGLER UPPER VENT CONTROL ASSEMBLY | S-55037200 |
| 1987-95 WRANGLER TRANSFER CASE SHIFTER LEVER | S-53003044 |
| 1987-95 WRANGLER HEAVY DUTY REAR SHOCK | S-83502837 |
| 1987-95 WRANGLER HEAVY DUTY FRONT SHOCK | S-83502836 |

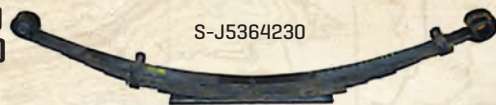

S-J5364230



S-55176281

S-55176280



S-55036899



S-55036371

Is your front drive shaft worn out? Do you have a bad vibration any time you shift into 4WD? Then your drive shaft could be the problem. We have a large supply of front and rear surplus drive shafts for many applications.



S-52088028 Wrangler front drive shaft with automatic transmission



S-52098221 rear drive shaft for 4.0L manual transmission



S-52089008



S-5EY13SA8

| Jeep® RHD & Export Surplus Stock | Part# |
|---|--------------|
| 1984-96 FRONT TRACK BAR BRACKET(RHD) CHEROKEE | S-52006508 |
| 1984-96 COWL FILTER SCREEN (RHD ONLY) | S-55027697 |
| 1984-96 COWL GRILL (RHD ONLY) | S-55027696 |
| 1984-96 RIGHT SIDE MIRROR (RHD ONLY) | S-55154683 |
| 1984-96 LEFT SIDE MIRROR (RHD ONLY) | S-55154734 |
| 1984-96 REAR LAMP ASSY, RIGHT SIDE (EXPORT ONLY) | S-55155464 |
| 1984-96 REAR LAMP ASSY, LEFT SIDE (EXPORT ONLY) | S-55155465 |
| 1984-96 FRONT FENDER TURN SIGNAL (EXPORT ONLY) | S-55055014 |
| 1984-96 RH HEAD LAMP (HELLA H4 55W-60W) W/O LEVEL DEVICE | S-55054828 |
| 1984-96 LH HEAD LAMP (HELLA H4 55W-60W) W/O LEVEL DEVICE | S-55054829 |
| 1984-96 DASH PAD ASSEMBLY (RHD ONLY) | S-5EY13SA8 |
| 1984-96 WOOD GRAIN INSTRUMENT BEZEL (RHD) | S-55115072 |
| 1996 FAN SHROUD 4.0L 6 CYL (RHD) | S-52028324 |
| 1996 ELECTRIC FAN ASSEMBLY (RHD) | S-52030035AB |
| 1996 COOLANT BOTTLE ASSEMBLY RHD, (EXPORT ONLY) | S-52079340 |
| 1984-96 SWITCH ASSEMBLY (WINDOW, DOOR) LH FRONT (RHD) | S-56007223 |
| 1984-96 SWITCH ASSEMBLY (WINDOW, DOOR) RH FRONT (RHD) | S-56010051 |
| 1984-96 INSTRUMENT CLUSTER (RHD, KILOMETERS) | S-56009018 |
| 1984-96 WIPER MOTOR ASSEMBLY, RHD | S-55155300 |
| 1997-01 POWER STEERING BOX, RHD ONLY | S-56022278AA |
| 1995-96 AIRBAG (STEERING WHEEL, BLACK) EXPORT ONLY, CANNOT BE SOLD IN DOMESTIC U.S. | S-5FL22SX8 |

S-55027697



S-55155465

S-55155464



S-52040110



S-55154734



S-52030035AB



OMIX-ADA, Inc.

S-55155300

| Jeep® Wrangler Surplus Stock | Part# |
|---|------------|
| 1987-95 PITMAN ARM, LHD WRANGLER W/ MANUAL STEERING. EXPORT ONLY, CANNOT BE SOLD IN DOMESTIC U.S. | S-52040110 |
| 1994-95 REAR DRIVE SHAFT (4.0L) WRANGLER W/ MAN TRAN AND 3 INCH SLIP YOKE | S-52098221 |
| 1987-95 WRANGLER 6-CYL W/ AX15 MANUAL TRAN, FLYWHEEL HOUSING | S-53007105 |
| 1981-96 CJ, WRANGLER WORLD CAB, DOOR RIGHT SIDE | S-55034394 |
| 1981-96 CJ, WRANGLER WORLD CAB, DOOR LEFT SIDE | S-55034395 |
| 1987-95 WRANGLER COWL GRILL W/ SCREEN | S-55175729 |
| 1991-95 WRANGLER HARDTOP SIDE VENT WINDOW - LH | S-55176281 |
| 1991-95 WRANGLER HARDTOP SIDE VENT WINDOW - RH | S-55176280 |
| 1987-95 WRANGLER GRILL AIR DEFLECTOR TOP, SIDES | S-55027504 |
| 1987-95 TEMP CONTROL CABLE ASSEMBLY | S-55036907 |

S-52006508



S-55154683



S-55034395

| | | | | | | | | | |
|-----------------------------|-----------------------------------|-----------------------------|----------------------------------|------------------------------|---------------------------------|--------------------------------|--|----------------------------|-----------------------------|
| ABS Speed Sensors | R64 | Cowl Panels | R10, R14 | Frame Parts | R11 | Rocker Guard | J13, C5, C47 | Tire Carriers | J10, J44, C4, C45, R9-14 |
| Accelerator Parts | R80 | Cowls Seals | R9, R17, R20 | Fuel | | Roll Bar Accessories | J34, C22 | Tire Covers | U8, J22, C13 |
| Air Cleaners | R81 | Crossmembers | R21-22 | Caps | R84 | RRC Side Armor | J13, C5 | Toolbox | R3, R11, R13 |
| Air Filters | J45, C55, X16, R81 | Cup Holders | U32, J34, C22, C24, X7, R21 | Carburetors | R81 | Seals | A11, C70, X27, R6-7, R42, R70, R73, R85, R87 | Tow Hooks | J53, C28, C33, C56, X14-15 |
| Air Intakes | J45, C55, X16 | CV Boots | R37 | Gauges | R66 | Seats | C37-40, X4 | Trac-Lok | R36 |
| Alternators | R57, R111 | Dash Panels | J26, C23, R11, R17 | Lines | R82 | Seat Belts | C39, R9-10, R13, R17, R20 | Transfer Bars | X14, R90, R93-94 |
| Ammeters | R67 | Dash Parts | R17 | PCV Valves | R81 | Seat Covers | J27, J31, C40, X5 | Transfer Case | |
| Antennas | R67 | Dash Storage | J25 | System Components | R81-84 | Seat Organizers | J27, X5 | Crossmember | X14, R8, R21 |
| Axe Clamp | R13 | Dashpads | R3, R17 | Tanks | R83 | Seat Protectors | J28, C41, X5 | Dana 18 | R95 |
| Axle | | Degree Wedges | O6, C61, R94 | Fuses | R65 | Shackle Brackets | R92 | Dana 20 | R96 |
| AMC 20 | R34-35 | Differential Cable | C70, X27 | Gauges | R66 | Shackles | 07-8, C61-62, X21, R92, R94 | Dana 300 | R97 |
| Assemblies | R112 | Differential Covers | A9, J43, J60, C46, C68, X14, X26 | Glove Box Doors | C23, R17 | Shift Forks | A11, C70, X27, R98-99, R106, R108 | Drive Chains | A11, C70, X27, R99 |
| Surplus | R112 | Dimmer Switches | R64 | Grab Handles | J35, C22 | Shift Knobs | X7, C21 | NP231 | R98, R112 |
| Chrysler 8.25" | A5, X25 | Distributors & Parts | R58-59 | Grille Inserts | J36, J42, C35 | Shift Rods | R95-97 | NP242 | R99 |
| Conversion Kits | R34 | Door Accessories | J32, C25 | Half Doors | J32 | Shovel Bracket | R14 | NP249 | R99 |
| Dana 25 | R24 | Door Glass Seals | R6 | Hard Top Insulation | J23 | Side Marker Lights | R5 | Quadra-Trac | R96 |
| Dana 27 | R24, R29 | Door Handles | C25, R16, R21, R22-23 | Hardtop Seals | R7 | Side Tube Steps | J14, C10, X2 | | |
| Dana 30 | R25-28 | Door Inserts | C25, R20 | Heating & AC | | Skid Plates | J43, C46, C48 | Transmission | |
| Dana 35 | R32-33, R112 | Door Latch Brackets | R16, R19 | A/C Compressors | R85 | Slip Yoke Eliminator | A11, C48, C69-70, X15, X27, 05, R98 | Automatics | R108, R112 |
| Dana 44 | R28-31, R36 | Door Locks | R19-23 | A/C Condensers | R85, R115 | Snorkel | J45 | AX-15 | R107-108 |
| Shafts | A1-8, J59, C66-67, X24-25, R24-36 | Door Seals | R16, R19 | A/C Parts | R85 | Soft Tops | | AX-4 | R105-106 |
| Snubbers | O9, C63, R92-100 | Door Skins | C16, C18 | Blower Motors | R85, R116 | Accessories | C13 | AX-5 | R105-106, R112 |
| Back-Up Lights | C53, U22, R5 | Door Straps | C25 | Heater Cables | R85 | Bowless Top | U6, C17 | BA-10 | R105 |
| Ball Joints | R91 | Door Window Seals | R6 | Heater Cores | R85 | Hardware | U10-11, J22, C18, U8, J21-22, C14-15 | Mounts | R108 |
| Battery Trays | R9, R11, R67 | Doors | J32, C45 | Heater Hoses | R53 | Island Toppers | U2-3, J18-19 | SR4 | R102 |
| Battery Trays, Dual | J47, C47 | Driveshafts | O4-5, J56, X15, R37, R112 | Heater Switches | R85 | Power Top | U2-3, J18-19 | Surplus | R112 |
| Bellcranks | R50-51 | Electrical | R57-64 | Hitches | J53, C3 | Seals | R7 | Assemblies | R112 |
| Bellhousings | R102-103, R108 | Engine | | Hood Catches | J40, C27, C29 | Specialty Tops | U9 | Synchronizers | R98-107 |
| Black Accessories | J37-38, C27-28 | Connecting Rods | R72-73 | Hood Lift Kits | J53, C47, X15 | Summer Briefs | U7, J20, C14 | T14 | R101 |
| Blackout Lamp Parts | R4 | Camshaft Bearings | R73 | Hood Locks | J44, C50 | Pocket Briefs | U7, J20-21, C13 | T15 | R101 |
| Body | | Camshaft Position Sensors | R63 | Horn Buttons | R86 | Windshield Channels | J21, C13 | T150 | R102 |
| Armor | J39, C34 | Camshafts | R72 | Horns | R53, R84 | XHD Replacement Tops | U4-5, C16 | T176 | R103 |
| Body Kits | R2 | Crankshaft Oil Seals | R70 | Hose Clamps | R42 | Solenoids | R58 | T18 | R102 |
| Fastener Kits | R15, R18 | Crankshaft Pilot Bearings | R71 | Hubs | R50 | Sound Accessories | C19 | T4 | R104 |
| | | Crankshaft Position Sensors | R63 | Idle Cross Shafts | R60-61, R64 | Spark Plugs & Wires | R61 | T5 | R104 |
| Grilles | R3, R10, R15, R21-23 | Cylinder Head Gaskets | R69 | Ignition Parts | R63 | Speedometers | R66 | T84 | R101 |
| Mount Kits | R8-15, R18 | Cylinder Heads | R73 | Intake Temperature Sensors | R63 | Spider Gears | A13, C72, R24-30, R32, R34, R36 | T90 | R100 |
| Panels | R3, R8-18, R113 | Intake Manifolds | R68, R70 | Interior Accessories | J30, C23-24, X7 | Spindle Nut Socket | R26, R42 | T98 | R101 |
| Parts | R1-23 | Main Bearing Sets | R71 | Interior Door Handles | C25 | Spreader Bars | U11, C18, R19 | Tube Doors | J32, C45 |
| Tubs | R2, R8-15, R18 | Driving Lights | R76 | Interior Storage | J26, C22 | Stainless Accessories | J40-42, C29-33, X8 | Tune-Up Kits | R61 |
| | | Fog Lights | U22, J51, R4 | Interior Trim Items | J29-31, C21 | Starters | R57-58 | Turn Signal Switches | R64 |
| Brake | | Guards | J37, J41, J52, C28, C31-32, C54 | Knock Sensors | R63 | Steering | | Turn Signals | R5, R113, R116 |
| Boosters | R38, R115 | Light Bars | U24, J38, J51, C53 | Liberty Parts | X28 | Columns | C23, R17, R87, R115 | U-Bolts | A10, R91-93 |
| Calipers & Parts | R41 | Light Kits | J52, C54 | License Plate Holder | U18 | Drag Links | J43, C49, R89-90 | U-Joints | A10, R24-27, R33, R35, R37 |
| Components | R42-47 | Lighting | U21-24, J49-52, C51-54, X12-13 | Liftgate Support Struts | R19-23 | Gear Box | R86-887 | UTV/ATV | U27-31 |
| Drums | R43 | Headlight Bezels | J36, J52, C35, C54, R4 | Lockers | | Knuckles | R24, R88 | Visor Covers | J25, C21 |
| Emergency Brake Parts | R46-R47 | Headlights | U22, C52, X13 | Locking Hubs | U20, C12, C66, X24 | Manual Steering Gear Boxes | R87 | Voltage Regulators | R65 |
| Hardware | R39-41 | Headlight Parts | R4-5, R64 | Main Shafts | R99-107 | Parts | J56, C49, X14, R86-90 | Weatherstrip | R6-21 |
| Hoses | O9, C63, X21 | Headlight Bezels | J36, J52, C35, C54, R4 | MAP Sensors | R63 | Pitman Arms | R88 | Wheels | |
| Light Switches | R65 | Headlights | U22, C52, X13 | Mini Van Parts | R111 | Shaft Couplings | R86 | Adaptors | A10, J17, C12, C69, X3, X26 |
| Lines | R39-40 | Headlight Parts | R4-5, R64 | Mirrors | R9-11, R14, R16-23 | Shafts | R86 | Bearings | R33, R41 |
| Master Cylinders | R38 | Lighting | U21-24, J49-52, C51-54, X12-13 | Multifunction Switches | U23, J50, C52, X13, R64-65, R85 | Tie Rods | C49, R89 | Lug Nuts | R42 |
| Pads | R46 | Light Kits | J52, C54 | Off Road Accessories | J43-44, J53, C45-50, C56, X15 | Tie Rod Ends | X14, R89-90 | Spacers | A10, J17, C12, C69, X3, X26 |
| Pedal Pads | R47 | Locks | C71, X27 | Outer Door Handles | R21 | Wheels | R86 | Studs | R33, R42 |
| Pedals | R47 | Locking Hubs | U20, C12, C66, X24 | Outer Tailgate Handles | R18 | Storage | J26-28, C19 | Wheels | J16-17, C12, X3, R9-11, R14 |
| Pedals | R47 | MAP Sensors | R63 | Overhead Console | J25, C24 | Sun Visors | J25, C21, R13, R17, 20 | Winch & Recovery | U17-19, J46, C42, X9-11 |
| Rotors | R45 | Mini Van Parts | R111 | Oxygen Sensors | R62, R116 | Surplus | R111-116 | Winch Rope | U18 |
| Shoes | R43 | Mirrors | R9-11, R14, R16-23 | Pedal Pads | R47 | Suspension | | Window Cranks | R17, R20 |
| Slotted Rotors | A10, C69, X26 | Multifunction Switches | U23, J50, C52, X13, R64-65, R85 | Pinion Bearings & Seals | R24-34 | Coil Springs | R93-94 | Window Regulators | R22, R115 |
| Splash Shields | R45 | Off Road Accessories | J43-44, J53, C45-50, C56, X15 | Power Brake Boosters | R38 | Leaf Spring Bushings | 92 | Window Regulators | R22, R115 |
| Bug Deflectors | J36, C26, X8 | Outer Door Handles | R21 | Power Steering Radio Bracket | R14 | Leaf Springs | 06-7, C61, X20, R91 | Windshield Frames | R8, R11-12, R14-15, R18 |
| Bug Shields | C28, C32 | Outer Tailgate Handles | R18 | Rear Storage | J28 | Lift Kits | 02-6, C58-61, X19, J55-56 | Windshield Seals | R6-7, R9, R11 |
| Bumpers | | Overhead Console | J25, C24 | Rearview Mirrors | C36, J33, R21 | Polyurethane Replacement Parts | 08-9, C62-63, X21 | Wipers | |
| Covers | R18, R22-23 | Oxygen Sensors | R62, R116 | Recovery Gear | U18-19, J47-48, C43-44, X10-11 | Shocks & Stabilizers | 03-7, C59-61, X19-20, J55-56, R91 | Arms | R110 |
| End Caps | R114 | Pedal Pads | R47 | Relays | R64-65 | Spring Bolts | R92 | Blades | R110 |
| Extensions | R18 | Pinion Bearings & Seals | R24-34 | Ring & Pinion | A9, J60, C68, C72, X26, X28 | Spring Plates | R92 | Motors | R109, R115-116 |
| Guards | C9, R21 | Pintle Hook | R9, R11, R13 | | | Steering Stabilizers | 03, J56, C59, X19, R88 | Switches | R109 |
| Replacement | R16, R18, R21-23 | Pivot Bolts | R92 | | | Sway Bar End Links | R89-90, R92, R94 | Washer Fluid Level Sensors | R109 |
| Rock Crawling | C8 | Power Brake Boosters | R38 | | | Tachometers | R66-67 | Windshield | R110 |
| RRC Bumpers | J11, C4 | Power Steering | R87-88 | | | Temperature Gauges | R66 | Washer Pumps | R110 |
| Tire Carriers | J10, C4 | Radio Bracket | R14 | | | Temperature Sending Units | R63 | Wiring Harnesses | R65 |
| Tube Bumpers | J11-12, C6-9, X2 | Rear Storage | J28 | | | Throttle Body Spacer | J45, C55, X16 | Yokes | A10, R24-37, R86, R95-99 |
| XHD Bumper | J8-9, C2 | Rearview Mirrors | C36, J33, R21 | | | Throttle Cables | R80 | | |
| XHD Rear Bumper | J10, C3 | Recovery Gear | U18-19, J47-48, C43-44, X10-11 | | | Throttle Position Sensors | R63 | | |
| Car Covers | J23, C15 | Relays | R64-65 | | | Tires | U33 | | |
| Cargo Liners | U16, J24, C20, X6 | Ring & Pinion | A9, J60, C68, C72, X26, X28 | | | | | | |
| Choke Cables | R80 | | | | | | | | |
| Clinometer | U30, C22, X7 | | | | | | | | |
| Clocks | R67 | | | | | | | | |
| Clutch/Flywheel | | | | | | | | | |
| Flywheels | R49-50 | | | | | | | | |
| Kits & Parts | R48-51 | | | | | | | | |
| Master Cylinder Cover Plate | R8, R14 | | | | | | | | |
| Pilot Bearings | R49, R71 | | | | | | | | |
| Commander Parts | X28 | | | | | | | | |
| Consoles | C24 | | | | | | | | |
| Cooling | | | | | | | | | |
| Cooling System | R52-56 | | | | | | | | |
| Fan Belts | R55 | | | | | | | | |
| Fan Clutches | R54 | | | | | | | | |
| Fan Shrouds | R53 | | | | | | | | |
| Idle Pulleys | R56 | | | | | | | | |
| Radiators & Parts | R52-R53 | | | | | | | | |
| Serpentine Belts | R56 | | | | | | | | |
| Thermostats | R55 | | | | | | | | |
| Water Pumps | R54 | | | | | | | | |

J: Wrangler 07-12
C: Cherokee/Grand Cherokee 07-06
X: Cherokee/Grand Cherokee 84-12
R: Replacement Parts
U: Accessories
O: ORV™
A: Alloy USA®



NEW! XHD ALUMINUM BUMPER SYSTEM FOR 07-12 JEEP® WRANGLER

OPTIONAL ALUMINUM
OVER-RIDER WITH
FRONT SLOPE

LIGHTER THAN
OE BUMPER

OPTIONAL
JK WINCH PLATE -
SPECIAL DESIGN FOR
THIS BUMPER

ALUMINUM STUBBY
BUMPER ENDS

ALUMINUM CENTER SECTION
WITH STEEL D-RINGS



**XHD ALUMINUM
REAR SYSTEM:**
XHD BUMPER PODS

OPTIONAL
XHD CENTER STEP



FAN PHOTOS

facebook.com/ruggedridge



AJ G. - GA



TAMAR K. - MARTINEZ, GA



FRED P. - GA



DOUG W. - NORTHFIELD, NJ



DUSTIN S. - CEDAR RAPIDS, IA



BRIAN T. - LOGANVILLE, GA



EUGENE D.



JON & BRANDON - MARTINSVILLE, NJ



TOMMY F.



DUSTIN H. - HOUSTON, TX



JONATHAN M.



NICHOLAS S.



PHIL S. - CASA GRANDE, AZ



MARK & TINA H. - ATTICA, IN

**Rugged
Ridge** 



PROTECTS YOUR VEHICLE'S INTERIOR FROM
WHATEVER NATURE THROWS AT YOU!

2012 Master Catalog - Part # 12510.01

ALL TERRAIN FLOOR LINERS

FOR JEEP®, TRUCK & SUV
SEE PAGES A14-A16 FOR MORE INFO & APPLICATIONS

CHEVRON SHAPED RAISED
PATTERN CHANNELS
WATER AND DIRT AWAY
FROM SHOES & CLOTHING.

HIGH PERIMETER WALL
PROVIDES MAXIMUM
PROTECTION AND
WATER RETENTION.

SPECIAL RAISED REINFORCED
HEEL AREA ALLOWS EASY
FOOT MOVEMENT WHILE
PROVIDING DURABILITY.

2-3 TIMES THE
THREAD HEIGHT OF
REGULAR VACUUM
FORMED LINERS

EXCLUSIVE SELF SEALING
FLOOR HOOK ATTACHMENT
KEEPS MOISTURE OUT
WHILE SECURING THE LINER.

ROLLED REINFORCED
EDGES PROVIDE ADDED
STRENGTH AND A
FINISHED LOOK



FIND US ON
FACEBOOK

FACEBOOK.COM/RUGGEDRIDGE



OMIX-ADA.COM | RUGGEDRIDGE.COM | OUTLANDAUTOMOTIVE.COM | ALLOYUSA.COM | PRECISIONGEAR.COM
OMIX-ADA, INC. 460 HORIZON DRIVE SUITE 400 SUWANNE, GA 30024 770-614-6101 INFO@OMIX-ADA.COM

Jeep®, Wrangler®, Cherokee®, Grand Cherokee®, JK®, TJ®, XJ®, CJ®, Jeep grille design and other names used in this catalog are registered trademarks of Chrysler LLC. Omix-ADA, Inc. or its licensees are not affiliated with Chrysler LLC. All parts listed are aftermarket replacement parts. Part numbers, illustrations and images used for reference purpose only. No implication is made that these are original equipment parts, from those sources whose part numbers are used here for reference or that they are approved by those companies. Omix-ADA®, Rugged Ridge®, Outland Automotive®, Alloy USA® and Precision Gear® names and logos are registered trademarks of Omix-ADA, Inc.